

**RECAMBIOS
MARINOS**

HONDA

FUERABORDA • OUTBOARD • FUORIBORDO • HORS-BORD

2021
2022



www.recambiosmarinos.es

HONDA

ES

GUÍA MANTENIMIENTO COLAS Y Y KITS	545	DESCONECTORES DE SEGURIDAD	561	JUNTAS BASE DE MOTOR	574
SISTEMA DE ALIMENTACIÓN Y FILTRACIÓN	547	LLAVES DE ARRANQUE	564	JUNTAS BOMBA DE ACEITE	574
ACEITE	553	MOTORES DE ARRANQUE	560	JUNTAS CULATA	574
BOMBA DE COMBUSTIBLE EN LÍNEA	547	SENSORES	557	JUNTAS SILENCIOSO	574
ABRAZADERA PARA MANGUERA	548	SENSOR DETONACIÓN	558	JUNTAS TAPÓN DRENAJE	575
ADAPTADOR LÍNEA DE COMBUSTIBLE	548	SENSOR MAP	557	KIT JUNTAS DE CULATA	575
BOMBA DE COMBUSTIBLE	547	SENSOR MAT, TEMPERATURA DEL AIRE	558	SISTEMA DE ESCAPE Y ADMISIÓN	576
LÍNEA DE COMBUSTIBLE	547	SENSOR POSICIÓN CIGÜEÑAL	557	SISTEMA DE ADMISIÓN	576
MANGUERA DE COMBUSTIBLE	547	SENSOR POSICIÓN LEVAS	557	JUNTAS	576
MUELLE TUBO COMBUSTIBLE	548	SENSOR PRESIÓN DE ACEITE	558	RETÉN DE VÁLVULA	576
BOMBA DE COMBUSTIBLE ELÉCTRICA	555	SENSOR OXÍGENO	558	SISTEMA DE ESCAPE	576
CARBURADOR	555	TRIM, TILT & POWER TRIM	562	RETÉN DE VÁLVULA	576
AGUJA DE CARBURADOR	555	EXTRACTOR TAPONES DE TRIM	563	UNIDADES DE TRANSMISIÓN	577
GUÍA CARBURADORES	556	INSTALACIÓN ELÉCTRICA	562	DESPIECE COLAS	577
KITS CARBURADORES	556	POWER TRIM COMPLETO	563	BF75AT • BF90AT	577
COMPONENTES TANQUE Y CONECTORES	548	TRIM COMPLETO	562	COMPONENTES DE COLA	578
CONECTOR DE DEPÓSITO	548	SISTEMA DE GOBIERNO	564	ARANDELA DE CIERRE	579
PASAMAMPAROS	549	CABLES DE CONTROL	565	EJE HÉLICE	579
FILTRO DE ACEITE	554	LLAVES DE ARANQUE	565	JUNTA EJE SELECTOR	578
GUÍA FILTROS DE ACEITE	554	MANDOS DE CONTROL	564	KITS JUNTAS Y RETENES	578
FILTRO DE COMBUSTIBLE Y ELEMENTOS	549	SISTEMA DE REFRIGERACIÓN	566	RETENES EJE DE CAMBIO	578
BRACKET	549	ÁNODOS	571	RETENES EJE DE HÉLICE	578
FILTRO COMBUSTIBLE MONTAJE EN LÍNEA	552	ÁNODO CANADA METAL	571	RETENES EJE DE TRANSMISIÓN	578
FILTRO COMBUSTIBLE SEPARADOR AGUA	549	ÁNODO TECNÓSEAL	573	RODAMIENTO DIÁBOLO	579
FILTRO DECANTADOR DE COMBUSTIBLE COMPLETO CON VASO TRANSPARENTE	550	BOMBA DE AGUA	569	RODAMIENTO PIÑÓN AVANTE	579
FILTRO DECANTADOR DE GASOLINA	550	JUNTAS BOMBA	569	TUERCA DE DIÁBOLO	579
LLAVES PARA FILTRO	552	KITS DE REPARACIÓN BOMBA DE AGUA	570	SISTEMA DE PROPULSIÓN	580
RACOR DE LATÓN	552	RETÉN CUERPO DE BOMBA	570	HÉLICES ALUMINIO E INOXIDABLE DE 3 Y 4 PALAS	580
INYECTORES	555	IMPULSORES	567	GUÍA HÉLICES CON NÚCLEO INTEGRADO	581
SISTEMA ELÉCTRICO	557	CHAVETA	569	HÉLICES PARA NÚCLEO INTERCAMBIABLE	582
ALTERNADORES	561	GUÍA IMPULSORES	568	NÚCLEO INTERCAMBIABLE	582
CORREAS DE ALTERNADOR	562	TERMOSTATO	566	REF --> RO	583
BOBINAS	559	PARTES DEL MOTOR	574	RO --> REF	585
BUJÍAS	559	GUÍA CORREAS DE DISTRIBUCIÓN	575		
		JUNTAS DE MOTOR	574		

EN

DRIVES MAINTENANCE GUIDE & KITS	545	SENSORS	557	ENGINE PARTS	574
FUEL & FILTRATION SYSTEM	547	SENSOR, CAMSHAFT	557	ENGINE GASKETS	574
CARBURETOR	555	SENSOR, CRANKSHAFT	557	GASKET, CYLINDER	574
CARBURETOR KITS	556	SENSOR, KNOCK	558	GASKET, CYLINDER HEAD	574
CARBURETOR NEEDLE VALVE	555	SENSOR, MAP	557	GASKET KIT	575
GUIDE CARBURETORS	556	SENSOR MAT, AIR TEMPERATURE	558	GASKET, MUFFLER	574
ELECTRIC FUEL PUMP	555	SENSOR, O2	558	GASKET, OIL PUMP	574
FUEL FILTERS AND ELEMENTS	549	SENSOR, PRESSURE OIL	558	O-RING, DRAIN CAP	575
BRACKET	549	SPARK	559	TIMING BELT	574
COMPLETE FUEL FILTER	550	STARTERS	560	EXHAUST & INTAKE SYSTEM	576
COMPLETE FUEL FILTER WITH TRANSPARENT BOWL	550	TRIM, TILT & POWER TRIM	562	EXHAUST SYSTEM	576
FILTER KEY	552	COMPLETE POWER TRIM ASSEMBLY	563	VALVE SEALS	576
IN-LINE FUEL FILTER	552	COMPLETE TRIM ASSEMBLY	562	INTAKE SYSTEM	576
RACORS	552	TRIM PLUGS EXTRACTOR	563	GASKETS & VALVE SEALS	576
WATER SEPARATING FUEL FILTER	549	WIRING HARNESS	561	UNIT DRIVES & COMPONENTS	577
FUEL PUMP IN LINE	547	STEERING SYSTEM	564	DRIVE COMPONENTS	577
CLAMP SMALL	548	ENGINE CONTROLS	564	CARRIER BEARING	579
COUPLER	548	CONSOLE CONTROL	564	FORWARD GEAR BEARING	579
FUEL HOSE	547	CONTROL CABLES	565	NUT, GEARCASE END	579
FUEL LINE ASSEMBLY	547	SIDE CONTROL	564	O-RING DRIVE SHAFT	578
SPRING, FUEL PIPE	548	IGNITION STARTER SWITCH	565	PROPELLER SHAFT	579
FUEL TANK COMPONENTS & CONNECTORS	548	COOLING SYSTEM	566	SEAL DRIVE SHAFT	578
TANK CONNECTOR	548	ANODES	571	SEAL KITS	578
THRU HULL	549	ANODES CANADA METAL	571	SEAL PROPELLER SHAFT	578
INYEKTOR	555	ANODES TECNÓSEAL	573	TAB WASHER	579
OIL	553	IMPELLERS	567	PROPULSION SYSTEM	580
OIL FILTER	554	IMPELLERS GUIDE	568	3 & 4 BLADE ALUMINIUM & SS PROPELLERS	580
OIL FILTER GUIDE	554	KEY	569	INTERCHANGEABLE HUB	582
ELECTRIC SYSTEM	557	TERMOSTAT	566	PROPELLERS APPLICATION WITH RUBBER HUB	581
ALTERNATOR	561	WATER PUMP	569	PROPELLERS FOR INTERCHANGEABLE HUB	582
ALTERNATOR BELT	562	SEAL WATER PUMP	570	REF --> OEM	583
COILS	559	SERVICE KIT	570	OEM --> REF	585
CUT OFF SWITCHES	561	WATER PUMP GASKET	569		

GUIDA MANUTENZIONE E KIT	545	MOTORINI AVVIAMENTO	560	GUARNIZIONE TAPPO DRENAGIO	575
SISTEMA DI ALIMENTAZIONE E FILTRAZIONE	547	SENSORE	557	GUARNIZIONE OLIO	574
CARBURATORE	555	SENSORE ALBERO A CAME	557	GUARNIZIONE SILENZIATORE	574
KIT CARBURATORI	556	SENSORE ALBERO MOTORE	557	GUARNIZIONE TESTATA	574
SPILLO CONICO CARBURATORE	555	SENSORE ANTIDETONAZIONE	558	KIT GUARNIZIONE TESTATA	575
COMPONENTI SERBATOIO E CONETTORI	548	SENSORE MAP	557	GUIDA CINGHIE DISTRIBUZIONE	575
ATTACCO SERBATOIO	548	SENSORE MAT, TEMPERATURA ARIA	558	SISTEMA DI SCARICO E ASPIRAZIONE	576
PASSASCAFO	549	SENSORE OSSIGENO	558	SISTEMA ASPIRAZIONE	576
FILTRI BENZINA E RACCORDI	549	SENSORE PRESSIONE DELL'OLIO	558	GUARNIZIONE	576
CHIAVE DA FILTRO	552	TRIM, TILT & POWER TRIM	562	TENUTE	576
FILTRO BENZINA ALTA PRESSIONE		ESTRATTORE PER TAPPI DI TRIM	563	SISTEMA SCARICO	576
FILTRO BENZINA PER MONTARE IN LINEA	552	INSTALLAZIONE ELETTRICA	562	TENUTE	576
FILTRO DECATATORE BENZINA	550	MOTORINO POWER TRIM COMPLETO	563		
FILTRO DI DECATAZIONE BENZINA COMPLETO CON VASCHETTA TRASPARENTE	550	MOTORINO TRIM COMPLETO	562	UNITÀ DI TRASMISSIONE	577
FILTRO SEPARATORE ACQUA-BENZINA	549	SISTEMA DI GUIDA	564	COMPONENTI PIEDI	578
RACCORDI	552	CAVI COMANDI	565	ASSE ELICA	579
SUPPORTO	549	COMANDI DI CONTROLLO	564	CUSCINETTO DIAVOLO	579
FILTRO OLIO	554	CHIAVI DI ACCENSIONE	565	CUSCINETTO PIGNONE AVANTI	579
GUIDA FILTRO OLIO	554	SISTEMA DI RAFFREDDAMENTO	566	DADO DIAVOLO	579
INIETTORE	555	ANODI	571	KIT GUARNIZIONE E TENUTE	578
OLIO	553	ANODI CANADA METAL	571	TENUTE ASSE DI CAMBIO	578
POMPA BENZINA ELETTRICA	555	ANODI TECNOSEAL	573	TENUTE ASSE DI ELICA	578
POMPA BENZINA IN LINEA	547	GIRANTE	567	TENUTE ASSE DI TRASMISSIONE	578
ADATTATORE	548	CIAVETTA	569	RONDELLA CHIUSURA	579
FASCETTE	548	GUIDA GIRANTE	568	PARTI PIEDI	577
MOLLA TUBO COMBUSTIBILE	548	POMPA ACQUA	569	BF75AT • BF90AT	577
TUBO BENZINA	547	GUARNIZIONE POMPA	569	SISTEMA DI PROPULSIONE	580
TUBO CARBURANTE	547	KIT RICAMBI POMPA ACQUA	570	HELICHE ALLUMINIO E INOX DA 2 E 4 PALE	580
SISTEMA ELETTRICO	557	TENUTE CORPO POMPA	570	ELICHE PER MOZZO INTERCAMBIABILE	582
ALTERNATORE	561	TERMOSTATO	566	GUIDA ELICHE CON MOZZO	581
CURROIA ALTERNATORE	562	PARTI MOTORE	574	MOZZO INTERCAMBIABILE	582
BOBINE	559	GUARNIZIONI MOTORE	574	REF --> RO	583
CANDELE	559	GUARNIZIONE BASE MOTORE	574	RO --> REF	585
CHIAVETTA DI SICUREZZA	561				
INTERRUTTORE DI STOP	561				
KIT	561				

GUIDE KITS DE MAINTENANCE	545	CAPTEUR DE CLIQUETIS	558	JOINTS DE POMPE À HUILE	574
SYSTÈME D'ALIMENTATION ET DE FILTRATION	547	CAPTEUR DE POSITION D'ARBRE À CAMES	557	JOINTS DE SILENCIEU	574
CARBURATEUR	555	CAPTEUR DE POSITION DU VILEBREQUIN	557	JOINTS DE VIDANGE	575
GUIDE DES CARBURATEURS	556	CAPTEUR MAP	557	KIT JOINTS DE MOTEUR	575
KIT CARBURATEUR	556	CAPTEUR MAT DE TEMPERATURE D'AIR	558	SYSTÈME D'ÉCHAPPEMENT ET SYSTÈME D'ADMISSION	576
POINTEAU CARBURATEUR	555	CAPTEUR PRESSION D'HUILE	558	SYSTÈME D'ADMISSION	576
COMPONENTS ET CONNECTEURS DU RÉSERVOIR	548	COUPE CIRCUIT DE SECURITE	561	JOINTS DE SOUPAPE	576
PASSE-CLOISON	549	KITS	561	SYSTÈME D'ÉCHAPPEMENT	576
RACCORDS DE RESERVOIR	548	DEMARREUR	560	JOINTS DE SOUPAPE	576
FILTRE À ESSENCE ET CARTOUCHE DE RECHANGE	549	TRIM, TILT & POWER TRIM	562	EMBASSES ET PIÈCES	577
CLÉ À FILTRE	552	INSTALLATION ELECTRIQUE	562	EMBASSES	577
FILTRE À ESSENCE EN LIGNE	552	KIT EXTRACTEUR	563	BF75AT • BF90AT	577
FILTRE DÉCANTEUR ESSENCE	550	MOTEUR DE TRIM	562	PIÈCES	578
FILTRE DÉCANTEUR ESSENCE AVEC BOL TRANSPARENT	550	POWER TRIM COMPLET	563	ARBRE D'HELICE	579
FILTRE SÉPARATEUR EAU-ESSENCE	549	SYSTÈME DE COMMANDE	564	ÉCROU DE DIABOLO	579
RACCORDS	552	BOITIER DE COMMANDE	564	JOINTS D'ARBRE DE SELECTEUR	578
TÊTE DE FILTRE À ESSENCE	549	CÂBLES DE COMMANDE	565	JOINTS SPI ARBRE DE CHANGEMENT	578
FILTRE À HUILE	554	CONTACTEUR À CLÉ	565	JOINTS SPI ARBRE DE TRASMISSION	578
GUIDE DES FILTRES À HUILE	554	SYSTÈME DE REFROIDISSEMENT	566	KITS JOINTS D'EMBASSES	578
HUILES	553	ANODES	571	RONDELLE FREIN	579
INJECTEURS	555	ANODE CANADA METAL	571	ROULEMENT DE DIABOLO	579
POIRE À CARBURANT	547	ANODE TECNOSEAL	573	ROULEMENT DE PIGNON AVANT	579
COLLIER	548	TURBINES	567	SYSTEME DE PROPULSION	580
RACCORD COUPLEUR	548	CLAVETTE	569	HELICE ALUMINIUM ET INOX 3 ET 4 PALES	580
RESSORT, TUYAU DE CARBURANT	548	GUIDE DE TURBINES	568	GUIDE DES HÉLICES ET MOYEUX	581
TUYAU CARBURANT	547	POMPE D'EAU	569	HELICES AVEC MOYEU INTERCHANGEABLE	582
POMPE À ESSENCE ÉLECTRIQUE	555	JOINTS SPI DE POMPE À EAU	570	MOYEU INTERCHANGEABLE	582
SYSTÈME ÉLECTRIQUE	557	JOINTS POMPE	569	REF --> RO	583
ALTERNATEUR	561	KIT REPARATION DE POMPE À EAU	570	RO --> REF	585
COURROIE D'ALTERNATEUR	562	TERMOSTAT	566		
BOBINES	559	PIÈCES MOTEUR	574		
BOUGIES	559	COURROIES DE DISTRIBUTION	575		
CAPTEURS	557	JOINTS DE MOTEUR	574		
CAPTEUR À OXYGENE	558	JOINTS DE CULASSE	574		
		JOINTS DE TÊTE MOTRICE	574		



GUÍA KITS MANTENIMIENTO MAINTENANCE GUIDE & KITS GUIDA MANUTENZIONE E KIT GUIDE KITS MAINTENANCE

	KIT	REF						
BF4 BF4.5 BF5		REC06211-ZV1-505	REC06192-ZV1-C00	KIT TURBINA	IMPELLER KIT	KIT GIRANTE	KIT TURBINE	1
		NGKBPR5ES		BUJÍA	SPARK PLUG	CANDELE	BOUGIE	1
		REC19300-881-761		TERMOSTATO	THERMOSTAT	TERMOSTATO	TERMOSTAT	1
		REC16910-GB2-005		FILTRO COMBUSTIBLE	FUEL FILTER	FILTRO COMBUSTIBILE	FILTRE À ESSENCE	1
		TEN01402		ÁNODO	ANODE	ANODO	ANODE	1
		PAGB/T91-2.5X30		PIN	PIN	PIN	GOUPILLE	1
BF8 BF9.9D BF10		REC06211-ZW9-505	REC19210-ZW9-013	TURBINA	IMPELLER	GIRANTE	TURBINE	1
		NGKCR5EH-9		BUJÍA	SPARK PLUG	CANDELE	BOUGIE	2
		PAF15-07000031		TERMOSTATO	THERMOSTAT	TERMOSTATO	TERMOSTAT	1
		REC16910-ZV4-015		FILTRO COMBUSTIBLE	FUEL FILTER	FILTRO COMBUSTIBILE	FILTRE À ESSENCE	1
		REC35-822626Q03		FILTRO DE ACEITE	OIL FILTER	FILTRO OLIO	FILTRE A HUILE	1
		CM41106-ZW9-09000		ÁNODO	ANODE	ANODO	ANODE	2
PAGB/T91-2.5X30		PIN	PIN	PIN	GOUPILLE	1		
BF9.9A BF15A		REC06211-ZV4-505	REC06192-ZV4-000	KIT TURBINA	IMPELLER KIT	KIT GIRANTE	KIT TURBINE	1
		REC19300-881-761		TERMOSTATO	THERMOSTAT	TERMOSTATO	TERMOSTAT	1
		NGKDR6HS		BUJÍA	SPARK PLUG	CANDELE	BOUGIE	2
		REC16910-ZV4-015		FILTRO COMBUSTIBLE	FUEL FILTER	FILTRO COMBUSTIBILE	FILTRE À ESSENCE	1
		TEN01402		ÁNODO	ANODE	ANODO	ANODE	1
		PAGB/T91-2.5X30		PIN	PIN	PIN	GOUPILLE	1
BF15D BF20D		REC06211-ZY0-505	REC06192-ZW9-A30	KIT TURBINA	IMPELLER KIT	KIT GIRANTE	KIT TURBINE	1
		PAGB/T91-2.5X30		PIN	PIN	PIN	GOUPILLE	1
		PAF15-07000031		TERMOSTATO	THERMOSTAT	TERMOSTATO	TERMOSTAT	1
		REC35-822626Q03		FILTRO DE ACEITE	OIL FILTER	FILTRO OLIO	FILTRE A HUILE	1
		NGKCR5EH-9		BUJÍA	SPARK PLUG	CANDELE	BOUGIE	2
		CM41106-ZW9-09000		ÁNODO	ANODE	ANODO	ANODE	2
BF25D BF30D		REC06211-ZV7-505	REC16910-ZV4-015	FILTRO COMBUSTIBLE	FUEL FILTER	FILTRO COMBUSTIBILE	FILTRE À ESSENCE	1
		REC35-822626Q03		FILTRO DE ACEITE	OIL FILTER	FILTRO OLIO	FILTRE A HUILE	1
		PAGB/T91-2.5X30		PIN	PIN	PIN	GOUPILLE	1
		PAF15-07000031		TERMOSTATO	THERMOSTAT	TERMOSTATO	TERMOSTAT	1
		REC06192-ZV7-000		KIT TURBINA	IMPELLER KIT	KIT GIRANTE	KIT TURBINE	1
		TEN01408/1		ÁNODO	ANODE	ANODO	ANODE	1
BF35A BF40A BF45A BF50A		REC06211-ZV5-505	REC06192-ZV5-003	KIT TURBINA	IMPELLER KIT	KIT GIRANTE	KIT TURBINE	1
		PAGB/T91-2.5X30		PIN	PIN	PIN	GOUPILLE	1
		NGKDR7EA		BUJÍA	SPARK PLUG	CANDELE	BOUGIE	3
		REC35-822626Q03		FILTRO DE ACEITE	OIL FILTER	FILTRO OLIO	FILTRE A HUILE	1
		PAF15-07000031		TERMOSTATO	THERMOSTAT	TERMOSTATO	TERMOSTAT	1
		CMHBF4050KITA		KIT ANODO	ANODE KIT	KIT ANODO	KIT ANODE	1
REC12-191833		JUNTA DRENAJE COLA	DRAIN PLUG GASKET	GUARNIZIONE DRENAGGIO	JOINT DE VIDANGE D'EMBASE	2		
PAF15-04000003		JUNTA DRENAJE COLA	DRAIN PLUG GASKET	GUARNIZIONE DRENAGGIO	JOINT DE VIDANGE D'EMBASE	1		
NGKDR7EA		BUJÍA	SPARK PLUG	CANDELE	BOUGIE	3		
REC12-191833		JUNTA DRENAJE COLA	DRAIN PLUG GASKET	GUARNIZIONE DRENAGGIO	JOINT DE VIDANGE D'EMBASE	2		
PAF15-04000003		JUNTA DRENAJE COLA	DRAIN PLUG GASKET	GUARNIZIONE DRENAGGIO	JOINT DE VIDANGE D'EMBASE	1		
REC16900-SA5-004		FILTRO COMBUSTIBLE	FUEL FILTER	FILTRO COMBUSTIBILE	FILTRE À ESSENCE	1		

HONDA

RECAMBIOS MARINOS

	KIT	REF								
BF40D BF50D		REC06211-ZZ3-505	REC06192-ZV5-003	KIT TURBINA	IMPELLER KIT	KIT GIRANTE	KIT TURBINE	1		
		PAGB/T91-2.5X30	PAGB/T91-2.5X30	PIN	PIN	PIN	GOUPILLE	1		
		NGKDR7EB	NGKDR7EB	BUJÍA	SPARK PLUG	CANDELE	BOUGIE	3		
		REC35-822626Q03	REC35-822626Q03	FILTRO DE ACEITE	OIL FILTER	FILTRO OLIO	FILTRE A HUILE	1		
		PAF15-07000031	PAF15-07000031	TERMOSTATO	THERMOSTAT	TERMOSTATO	TERMOSTAT	1		
		CMHBF4050KITA	CMHBF4050KITA	KIT ANODO	ANODE KIT	KIT ANODO	KIT ANODE	1		
		REC12-191833	REC12-191833	JUNTA DRENAJE COLA	DRAIN PLUG GASKET	GUARNIZIONE DRENAGGIO	JOINT DE VIDANGE D'EMBASE	2		
		PAF15-04000003	PAF15-04000003	JUNTA DRENAJE COLA	DRAIN PLUG GASKET	GUARNIZIONE DRENAGGIO	JOINT DE VIDANGE D'EMBASE	1		
		REC16911-ZZ5-003	REC16911-ZZ5-003	FILTRO COMBUSTIBLE	FUEL FILTER	FILTRO COMBUSTIBILE	FILTRE À ESSENCE	1		
		BF60A		REC06211-ZZ3-506	REC19210-ZV5-003	TURBINA	IMPELLER	GIRANTE	TURBINE	1
REC90752-ZV5-003	REC90752-ZV5-003			CHAVETA TURBINA	IMPELLER KEY	CHIAVE GIRANTE	CLAVETTE TURBINE	1		
NGKLMAR6C-9	NGKLMAR6C-9			BUJÍA	SPARK PLUG	CANDELE	BOUGIE	3		
PAGB/T91-2.5X30	PAGB/T91-2.5X30			PIN	PIN	PIN	GOUPILLE	1		
PAF15-07000031	PAF15-07000031			TERMOSTATO	THERMOSTAT	TERMOSTATO	TERMOSTAT	1		
CMHBF35225KITA	CMHBF35225KITA			KIT ANODO	ANODE KIT	KIT ANODO	KIT ANODE	1		
REC12-191833	REC12-191833			JUNTA DRENAJE COLA	DRAIN PLUG GASKET	GUARNIZIONE DRENAGGIO	JOINT DE VIDANGE D'EMBASE	2		
PAF15-04000003	PAF15-04000003			JUNTA DRENAJE COLA	DRAIN PLUG GASKET	GUARNIZIONE DRENAGGIO	JOINT DE VIDANGE D'EMBASE	1		
REC35-822626Q03	REC35-822626Q03			FILTRO DE ACEITE	OIL FILTER	FILTRO OLIO	FILTRE A HUILE	1		
REC16911-ZZ5-003	REC16911-ZZ5-003			FILTRO COMBUSTIBLE	FUEL FILTER	FILTRO COMBUSTIBILE	FILTRE À ESSENCE	1		
BF75A BF90A (1200002)		REC06211-ZW0-505	REC06192-ZV1-305	KIT TURBINA	IMPELLER KIT	KIT GIRANTE	KIT TURBINE	1		
		REC19300-ZV5-043	REC19300-ZV5-043	TERMOSTATO	THERMOSTAT	TERMOSTATO	TERMOSTAT	1		
		REC15400-RBA-F01	REC15400-RBA-F01	FILTRO DE ACEITE	OIL FILTER	FILTRO OLIO	FILTRE A HUILE	1		
		NGKDR7EA	NGKDR7EA	BUJÍA	SPARK PLUG	CANDELE	BOUGIE	4		
		PAGB/T91-2.5X30	PAGB/T91-2.5X30	PIN	PIN	PIN	GOUPILLE	1		
		REC12-191833	REC12-191833	JUNTA DRENAJE COLA	DRAIN PLUG GASKET	GUARNIZIONE DRENAGGIO	JOINT DE VIDANGE D'EMBASE	2		
		PAF15-04000003	PAF15-04000003	JUNTA DRENAJE COLA	DRAIN PLUG GASKET	GUARNIZIONE DRENAGGIO	JOINT DE VIDANGE D'EMBASE	1		
		CMHBF75115KITA	CMHBF75115KITA	KIT ANODO	ANODE KIT	KIT ANODO	KIT ANODE	1		
		REC16900-SA5-004	REC16900-SA5-004	FILTRO COMBUSTIBLE	FUEL FILTER	FILTRO COMBUSTIBILE	FILTRE À ESSENCE	1		
		BF75D BF90D		REC06211-ZY9-505	REC06192-ZV1-000	KIT TURBINA	IMPELLER KIT	KIT GIRANTE	KIT TURBINE	1
PAGB/T91-2.5X30	PAGB/T91-2.5X30			PIN	PIN	PIN	GOUPILLE	1		
NGKIZFR6K11	NGKIZFR6K11			BUJÍA	SPARK PLUG	CANDELE	BOUGIE	4		
REC15400-RBA-F01	REC15400-RBA-F01			FILTRO DE ACEITE	OIL FILTER	FILTRO OLIO	FILTRE A HUILE	1		
CMHBF75115KITA	CMHBF75115KITA			KIT ANODO	ANODE KIT	KIT ANODO	KIT ANODE	1		
REC19300-ZV5-043	REC19300-ZV5-043			TERMOSTATO	THERMOSTAT	TERMOSTATO	TERMOSTAT	1		
REC12-191833	REC12-191833			JUNTA DRENAJE COLA	DRAIN PLUG GASKET	GUARNIZIONE DRENAGGIO	JOINT DE VIDANGE D'EMBASE	2		
PAF15-04000003	PAF15-04000003			JUNTA DRENAJE COLA	DRAIN PLUG GASKET	GUARNIZIONE DRENAGGIO	JOINT DE VIDANGE D'EMBASE	1		
REC16900-SR3-004	REC16900-SR3-004			FILTRO COMBUSTIBLE	FUEL FILTER	FILTRO COMBUSTIBILE	FILTRE À ESSENCE	1		
REC16911-ZY3-010	REC16911-ZY3-010			FILTRO COMBUSTIBLE	FUEL FILTER	FILTRO COMBUSTIBILE	FILTRE À ESSENCE	1		
BF115A BF130A		REC06211-ZW5-505	REC06192-ZV1-000	KIT TURBINA	IMPELLER KIT	KIT GIRANTE	KIT TURBINE	1		
		REC15400-RBA-F01	REC15400-RBA-F01	FILTRO DE ACEITE	OIL FILTER	FILTRO OLIO	FILTRE A HUILE	1		
		NGKZFR7F	NGKZFR7F	BUJÍA	SPARK PLUG	CANDELE	BOUGIE	4		
		REC12-191833	REC12-191833	JUNTA DRENAJE COLA	DRAIN PLUG GASKET	GUARNIZIONE DRENAGGIO	JOINT DE VIDANGE D'EMBASE	2		
		PAF15-04000003	PAF15-04000003	JUNTA DRENAJE COLA	DRAIN PLUG GASKET	GUARNIZIONE DRENAGGIO	JOINT DE VIDANGE D'EMBASE	1		
		CMHBF75115KITA	CMHBF75115KITA	KIT ANODO	ANODE KIT	KIT ANODO	KIT ANODE	1		
		REC16911-ZY3-010	REC16911-ZY3-010	FILTRO COMBUSTIBLE	FUEL FILTER	FILTRO COMBUSTIBILE	FILTRE À ESSENCE	1		
		REC16900-SR3-004	REC16900-SR3-004	FILTRO COMBUSTIBLE	FUEL FILTER	FILTRO COMBUSTIBILE	FILTRE À ESSENCE	1		
		BF135A BF150A		REC06211-ZY5-505	REC06192-ZY6-000	KIT TURBINA	IMPELLER KIT	KIT GIRANTE	KIT TURBINE	1
				PAGB/T91-2.5X30	PAGB/T91-2.5X30	PIN	PIN	PIN	GOUPILLE	1
REC15400-RBA-F01	REC15400-RBA-F01			FILTRO DE ACEITE	OIL FILTER	FILTRO OLIO	FILTRE A HUILE	1		
NGKIZFR6K11	NGKIZFR6K11			BUJÍA	SPARK PLUG	CANDELE	BOUGIE	4		
REC12-191833	REC12-191833			JUNTA DRENAJE COLA	DRAIN PLUG GASKET	GUARNIZIONE DRENAGGIO	JOINT DE VIDANGE D'EMBASE	2		
PAF15-04000003	PAF15-04000003			JUNTA DRENAJE COLA	DRAIN PLUG GASKET	GUARNIZIONE DRENAGGIO	JOINT DE VIDANGE D'EMBASE	1		
CMHBF35225KITA	CMHBF35225KITA			KIT ANODO	ANODE KIT	KIT ANODO	KIT ANODE	1		
REC16911-ZY3-010	REC16911-ZY3-010			FILTRO COMBUSTIBLE	FUEL FILTER	FILTRO COMBUSTIBILE	FILTRE À ESSENCE	1		
BF175A BF200A BF225A				REC06211-ZY2-506	REC06192-ZY3-000	KIT TURBINA	IMPELLER KIT	KIT GIRANTE	KIT TURBINE	1
				REC15400-PLM-A01PE	REC15400-PLM-A01PE	FILTRO DE ACEITE	OIL FILTER	FILTRO OLIO	FILTRE A HUILE	1
		NGKIZFR6K11	NGKIZFR6K11	BUJÍA	SPARK PLUG	CANDELE	BOUGIE	6		
		PAF15-07000031	PAF15-07000031	TERMOSTATO	THERMOSTAT	TERMOSTATO	TERMOSTAT	1		
		PAGB/T91-2.5X30	PAGB/T91-2.5X30	PIN	PIN	PIN	GOUPILLE	1		
		REC12-191833	REC12-191833	JUNTA DRENAJE COLA	DRAIN PLUG GASKET	GUARNIZIONE DRENAGGIO	JOINT DE VIDANGE D'EMBASE	2		
		PAF15-04000003	PAF15-04000003	JUNTA DRENAJE COLA	DRAIN PLUG GASKET	GUARNIZIONE DRENAGGIO	JOINT DE VIDANGE D'EMBASE	1		
		CMHBF35225KITA	CMHBF35225KITA	KIT ANODO	ANODE KIT	KIT ANODO	KIT ANODE	1		
		REC16911-ZY3-010	REC16911-ZY3-010	FILTRO COMBUSTIBLE	FUEL FILTER	FILTRO COMBUSTIBILE	FILTRE À ESSENCE	1		

SISTEMA DE ALIMENTACIÓN Y FILTRACIÓN FUEL & FILTRATION SYSTEM

SISTEMA DI ALIMENTAZIONE E FILTRAZIONE SYSTÈME D'ALIMENTATION ET DE FILTRATION

BOMBA DE COMBUSTIBLE FUEL PUMP POMPA BENZINA POIRE À CARBURANT



BOMBA DE COMBUSTIBLE FUEL PUMP POMPA BENZINA POIRE À CARBURANT

Fabricada con elastómeros termoplásticos inyectados, resistentes al alcohol y rayos UV.s

Premium quality bulb resistance to alcohol as well as UV and ozone.

Fabbricata con elastomero termoplastico, resistente ai solventi e raggi UV.

Fabriqué avec des élastomères thermoplastiques injectés, résistant aux carburants et aux rayons UV.

REF		
GS31187	1/4" = 6 mm	1
GS31090	5/16" = 8 mm	1
GS31095	3/8" = 9.5 mm	1
GS31090	5/16" = 8 mm	1

GOLDENSHIP





LÍNEA DE COMBUSTIBLE FUEL LINE ASSEMBLY TUBO CARBURANTE TUYAU CARBURANT

Universal. Manguera resistente al alcohol.

Universal. Alcohol resistant hose.



Universale. Tubo resistente ai solventi.

Universel. Tuyau résistant à l'alcohol.

REF		
GS31096	5/16" x 2 m	1
GS31097	3/8" x 2 m	1
GS31099	8 mm x 2 m	1
SIE18-8013	5/16" x 2 m	1
SIE18-8015	3/8" x 2 m	1



SIE18-8013
SIE18-8015

REF		
GS31189	3/8" x 2 m	1

MADE IN THE USA **GOLDENSHIP**



REF		
GS31183	6 mm x 2 m	1

GOLDENSHIP

new





MANGUERA DE COMBUSTIBLE FUEL HOSE TUBO BENZINA TUYAU CARBURANT

Manguera «Trident» para líneas de combustible. Con refuerzo termoplástico que le permite excelente flexibilidad y resistencia a los rayos UV. Color gris. Resistente al alcohol. Especialmente indicado para motores fueraborda. Garantía: 3 años

Marine fuel hose (distribution and vent) for outboards. Fuel resistant thermo-plastic formulation with 2 spiral reinforcement provides excellent bendability and resistance to UV, aging and permeation by all marine fuels (gasoline/petrol and diesel) including alcohol blends. Warranty: 3 years

Tubo «Trident» per linea combustibile. Con rinforzo termoplastico che gli permette un'eccellente flessibilità e resistenza ai raggi UV. Colore grigio. Resistente ai solventi. Indicato per i motori fuoribordo. Garanzia: 3 anni

Tuyau «Trident» pour carburant. Avec renfort thermoplastique qui permet une excellente flexibilité et résistance aux rayons UV. Gris. Résistant à l'alcohol. Convient particulièrement aux moteurs hors-bord. Garantie: 3 ans

REF				
TRI305-0566	5/16" = 7,92 mm	15 m	1	SAEJ1527
TRI305-0386	3/8" = 9,53 mm	15 m	1	ISO-8469 B1 CE



TRIDENT



De goma para diesel y gasolina sin plomo. Ideal para fueraborda. Refuerzos textiles internos. Muy flexible. Contenido aromático 50%

Rubber Hose suitable for loading mineral oils, diesel and unloaded fuel

In gomma per diesel e benzina senza piombo. Ideale per motori fuoribordo. Tessuto interno rinforzato. Molto flessibile.

Caoutchouc pour diesel et essence sans plomb. Idéal pour le hors-bord. Renforts textiles internes. Très flexible

CARBUPOMP/10NL

REF						
GS35031	6x12	10 bar	50 mm	-25°C → 80°C	50 m	ISO R1307
GS35032	8x15	10 bar	65 mm		50 m	

H.T. - CARBUPOMP/10NL - WP 10 BAR - R-1M Q/m - ISO R1307

ht hoses technology

MUELLE TUBO COMBUSTIBLE

SPRING, FUEL PIPE

MOLLA TUBO COMBUSTIBLE

RESSORT, TUYAU DE CARBURANT

new

REF
PAF4-04000030
PAF4-05000010



ABRAZADERA

CLAMP SMALL

FASCETTE

COLLIER

new

REF	
REC650-24351-51	6 mm
REC6E5-24351-51	8 mm



REF		
REC09401-11425	6-8 mm	1
REC09401-11425BULK	6-8 mm	25



ADPATADOR LÍNEA DE COMBUSTIBLE

COUPLER

ADATTATORE

RACCORD COUPLEUR

REF	
REC22-8M0001721	Ø 11 mm --> Ø 9 mm



COMPONENTES TANQUE Y CONECTORES

FUEL TANK COMPONENTS & CONNECTORS

COMPONENTI SERBATOIO E CONETTORI

COMPOSANTS ET CONNECTEURS DU RÉSERVOIR

CONECTOR DE DEPÓSITO

TANK CONNECTOR

ATTACCO SERBATOIO

RACCORDS DE RESERVOIR

Fabricado en latón.

Made in machined brass.

Fabbricato in ottone.

Coûde MF 1/4" NPT en laiton.

REF		
GS31068	1/4" NPT	1



Para conectar dos motores a un sólo depósito, o viceversa. Fabricado en latón.

To connect two motors to a single tank, or vice versa. Made in machined brass

Per collegare due motori a un singolo serbatoio o viceversa. Fabbricato in ottone.

Té en laiton, pour connecter deux moteurs à un même réservoir, ou inversement.

REF		
GS31069	1/4" NPT	1



REF	OEM
REC17710-ZW9-033	17710-ZW9-023 17710-ZW9-033
BF4 --> BF130 HP	

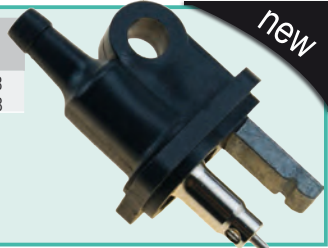

new

REF	OEM	
GS31030	17660-ZV5-902	3/8"
	antigüos old vecchio ancien	



GOLDENSHIP MADE IN THE USA

REF	OEM	
GS31031	17660-ZV5-A00 17660-ZW9-003	1/4" NPT 3/8"
	nuevos news nuovo nouveau	



GOLDENSHIP MADE IN THE USA

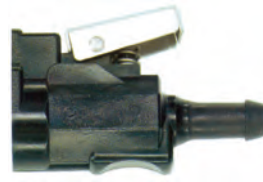

REF	OEM	
GS31034	17650-921-003ZB	3/8"
	antigüos old vecchio ancien	



GOLDENSHIP MADE IN THE USA

REF	OEM	
GS31033	116977-ZV5-A00	1/4" NPT

nuevos | news | nuovo | nouveau

REF	OEM	
GS31032	116977-ZV5-900	1/4" NPT

antigos | old | vecchio | ancien





PASAMAMPAROS	THRU HULL	PASSASCAFO	PASSE-CLOISON
Para atravesar mamparos de hasta 12 mm. Fabricado en latón.	For bulkhead up to 12 mm. Made in machined brass.	Per attraversare paratie fino a 12 mm. Fabricato in ottone.	Pour traverser des cloisons jusqu'à 12 mm. Fait en laiton.

REF		
GS31064	3/8"	1



FILTRO DE COMBUSTIBLE Y ELEMENTOS	FUEL FILTERS AND ELEMENTS	FILTRI BENZINA E RACCORDI	FILTRE A ESSENCE ET CARTOUCHE DE RECHANGE
BRACKET	BRACKET	SUPPORTO	TÊTE DE FILTRE À ESSENCE
Con 2 tapones de bronce y 2 tubos de extensión. (2 entradas y 2 salidas).	With 2 brass plugs and 2 extension tubes. (2 inputs & 2 outputs).	Con 2 tappi di bronzo e 2 tubi di estensione. (2 ingressi entrata carburante e 2 uscite carburante).	Avec 2 bouchons en bronze et 2 tubes d'extension. (2 entrées et 2 sorties).

REF		
REC25000	1/4"	AL
REC25010	1/4"	INOX /SS AISI316
REC25020	3/8"	AL
REC25030	3/8"	INOX /SS AISI316
RECOBBRACKET	1/4"	Plástico Plastic Plastica Plastique



REC25000 - REC25020 REC25010 - REC25030 RECOBBRACKET

FILTRO COMBUSTIBLE SEPARADOR DE AGUA	WATER SEPARATING FUEL FILTER	FILTRO SEPARATORE ACQUA-BENZINA	FILTRE SEPARATEUR EAU-ESSENCE	
REC24942	06177-ZX2-000HE	10	47/16"	11 cm
REC35-802893Q01		10	33/4"	
REC855686		28	47/16"	
REC35-802893Q		25	33/4"	
RACPF5510		10	47/16"	





RACPF5510 REC24942 REC35-802893Q01 REC855686 REC35-802893Q





Filtro original.	OEM filter.	Filtro benzina originale.	Filtre à essence d'origine
REF	MICRON		
RM35-802893Q	10	33/4"	



FILTRO CON BRACKET	OEM FILTER WITH BRACKET	FILTRO BENZINA CON SUPPORTO	FILTRE A ESSENCE AVEC SUPPORT
Con 2 tapones de bronce y 1 tubo de extensión.	With 2 brass plugs & 1 extension tube.	Con 2 tappi di bronzo e 1 tubo di estensione.	Avec 2 bouchons en bronze et 1 tube d'extension

REF	RO OEM	MICRON			BRACKET
REC24950		25	1/4"	50 GPH	AL
REC24952	06177-ZX2-000HE	10	1/4"	50 GPH	AL





FILTRO DECANTADOR DE COMBUSTIBLE COMPLETO CON VASO TRASPARENTE

COMPLET FUEL FILTER WITH TRANSPARENT BOWL

FILTRO DI DECANTAZIONE BENZINA COMPLETO CON VASCHETTA TRASPARENTE

FILTRE DÉCANTEUR ESSENCE AVEC BOL TRANSPARENT

REF		
RAC320R-RAC-01		AL
RAC320R-RAC-03	RACS3213 LENS3213	Plástico Plastic Plastica Plastique

RACOR



REF			
RECOBIFILALU			AL
RECOBFILTER	RECOBELEMENT LENS3213	150 l/h	Plástico Plastic Plastica Plastique

RECMAR







FILTRO CON BOMBA CEBADORA

FILTER WITH PRIMING PUMP

FILTRO CON PEMPETA PER RIEMPIRE

FILTRE A ESSENCE AVEC POMPE D'AMORCAGE

REF		MICRON			
RAC490R-RAC-01	RACS3227 LENS3227	10	340 l/h	3/8" NPTF	150 hp

RACOR



FILTRO DECANTADOR GASOLINA

COMPLETE FUEL FILTER

FILTRO DECANTATORE BENZINA

FILTRE DÉCANTEUR ESSENCE

Filtro de combustible con braket.

Complete fuel filter with braket.

Filtro combustibile con supporto.

Filtre à carburant avec support.

REF		MICRON
RAC23299-10	RAC23289-10	130 HP (4 T/ Strokes)

RACOR



REF	MICRON	
PAF40-0701000EI	10	70 hp



Ø 6 mm



new

REF	OEM		R.O. / OEM	MICRON		
REC90794-46866		REC90794-46868		10	117 l/h	175 hp



LLAVE PARA FILTRO
 FILTER KEY
 CHIAVE DA FILTRO
 CLÉ A FILTRE

REF
RECYS-225-15



RACOR.



REF	RAC120R-RAC-01	RAC320R-RAC-01	RAC320R-INOX-01 RAC320R-RAC-03	RAC320R-RAC-02 RAC320R-INOX-02
RO /OEM	06178-ZW1-030GH		06177-ZW1-801AH	
FLUJO MÁXIMO MAX. FLOW FLUSSO MASSIMO FLUX MAXIMAL	114 l/h 30 gph	340 l/h 60 gph	340 l/h 60 gph	340 l/h 60 gph
ELEMENTO ELEMENT ELEMENTO ÉLÉMENT	RACS3240 LENS3240	RACS3213 LENS3213	RACS3213 LENS3213	RACS3220UL
CAZOLETA TRANSPARENTE (sólo se recomienda para fueraborda.) CLEAR BOWL (Just for outboards) VASCHETTA TRASPARENTE (Solo nei fuoribordo.) BOL TRANSPARENT (uniquement recommandé pour le hors-bord.)	17670-ZW1-030GH		17670-ZW1-801AH	
ROSCAS CENTRALES CENTRAL THREADS FILETTO CENTRALE TAILLE DU FILETAGE POUR LA CARTOUCHE	M18 x 1.5	1 1/4"	1 1/4"	1 1/4"
TAMAÑO ROSCA CABEZA HEAD PORT SIZE DIMENSIONE VITE TESTA TAILLE DU FILETAGE POUR LES RACCORDS	1/4-18 NPTF	1/4-18 NPTF	1/4-18 NPTF	1/4-18 NPTF
ALTURA X Ø HEIGHT X Ø ALTEZZA X Ø HAUTEUR X Ø	166 x 81 mm	238 x 102 mm	238 x 102 mm	238 x 102 mm
PESO WEIGHT PESO POIDS	0,5 kg	0,9 kg	0,9 kg	0,9 kg
CAIDA DE PRESIÓN PRESSURE DROP CADUTA DI PRESSIONE CHUTE DE PRESSION	0.15 PSI 0.01 bar	0.61 PSI 0.04 bar	0.61 PSI 0.04 bar	0.61 PSI 0.04 bar
PRESIÓN MÁXIMA MAX. PRESSURE PRESSIONE MASSIMA PRESSION MAXIMALE	7 PSI 0.05 bar	7 PSI 0.05 bar	7 PSI 0.05 bar	7 PSI 0.05 bar
DESMONTAJE CARTUCHO-CAZOLETA ELEMENT REMOVAL UNDERBOWL RIMOZIONE DELLA CARTUCCIA DEMONTAGE DE LA CARTOUCHE	25,4 mm 1"	25,4 mm 1"	25,4 mm 1"	25,4 mm 1"
TEMPERATURA DE TRABAJO OPERATING TEMPERATURE TEMPERATURA DI LAVORO TEMPERATURE DE TRAVAIL	-40°C +124°C			

RÁCORES		RACORS		RACCORDI			RACCORDS				
REF											
GS31065	1/4" NPT	3/8" = 9.5 mm	1	GS31066	1/4" NPT	5/16" = 7.9 mm	2	GS31067	1/4" NPT	3/8" = 9.5 mm	2
GS31166	1/4" NPT	5/16" = 7.9 mm	2								
GS31155	3/8" NPT	3/8" = 9.5 mm	2								
GS31156	3/8" NPT	5/16" = 7.9 mm	2								
GS31157	3/8" NPT	1/4" = 6.4 mm	2								

LLAVES PARA FILTRO		FILTER KEY		CHIAVE DA FILTRO		CLÉ À FILTRE	
REF				REF			
RACRK22628				REC70720	65 - 110 mm		

FILTRO COMBUSTIBLE PARA MONTAJE EN LÍNEA		IN-LINE FUEL FILTER	
REF			
GS31001	50 l/h	6-8 mm	plástico plastic
GS31002	150 l/h	8-10 mm	plástica plastique

GS31001 GS31002

FILTRO BENZINA PER MONTARE IN LINEA		FILTRE A ESSENCE EN LIGNE	
REF	OEM		
REC16910-ZV4-015	16910-ZV4-015	BF15AM/B/D3/DK2	BF90DK0/DK2/DK4
		BF8C/CX/B1/B2/D1/D2/	BF100A
		P8B1/P8B2/DK2	BF60A/AK1
		BF9.9AH/AK/AM/B/DK2/D1	BF80A
		BF25D4/DK2/A/A1/AX	
		BF30D4/DK2/A/A1/AX	
		BF20A/AX/D3	
		BF10B1/D1/P10B1/DH/DK2	
		BF75DK0/DK2/DK3	
		BF40D/DK2	
		BF50D/DK2	

FILTRO COMBUSTIBLE PARA MONTAJE EN LÍNEA		IN-LINE FUEL FILTER	
REF			
GS30435	6, 8, 10 mm	metal + cristal metal + crystal	1
		metallo + cristallo métal + verre	

GS30435

FILTRO COMBUSTIBLE PARA MONTAJE EN LÍNEA		IN-LINE FUEL FILTER	
REF	OEM		
REC16900-SA5-004	16900-SA5-004	BF35AM	
		BF40B/B2/BX/A4/A1/A2/AX/A3/AY	
		BF45AM	
		BF75A1/AT/AV/AX/A2/A3	
		BF90A1/AF/AV/AX/A2/A3	
		BF50A4/A1/A2/AX/A3/AY	
		(14ZW00E1M)	

FILTRO COMBUSTIBLE PARA MONTAJE EN LÍNEA		IN-LINE FUEL FILTER	
REF	OEM		
REC40145		1/4"	1/4"
REC40155		5/16"	5/16"
REC40165		3/8"	3/8"
REC40135		5/16"	3/8"

FILTRO COMBUSTIBLE PARA MONTAJE EN LÍNEA		IN-LINE FUEL FILTER	
REF	OEM		
REC16910-GB2-005	16900-GB2-005	BF4.5B/BX/B2/B4/B6	
		BF5A1/AH/AK/AM/AX/A2/A3/A4	
		BF6B/BX/D6	
		BF8AX/BX/AH/AK/AM	
		BF50F	
		BF75F	
		BF100F	

FILTRO COMBUSTIBLE PARA MONTAJE EN LÍNEA		IN-LINE FUEL FILTER	
REF	OEM		
REC16900-SR3-004	16900-SR3-004	BF115A1 / A2 / A3 / AX	
		BF130A1 / A2 / A3 / AX	
		Series #14ZW50E1M	

REF	OEM
REC16901-ZY3-003	16901-ZY3-003 16911-ZY3-003

 BF115
 BF135
 BF150
 BF175
 BF200
 BF225
 BF250





REF	OEM
REC16911-ZZ5-003	16911-ZZ5-003

 BF40D, DK2, DK4, E
 DF50D, DK2, DK4
 BF60A, AK1
 BFF60A, AK1



REF	OEM
REC16911-ZY3-010	16911-ZY3-010



 BF80A
 BF100A
 BF90D2 / D4 / DK0
 BF75DK2 / DK3 / DK0
 BF150AK2 / A4
 BF135AK2 / A4
 BF225AK2 / AK3 / AK1 / A6
 BF200AK2 / AK3 / AK1 / A6
 BF175AK2 / AK3 / AK1 / A6
 BF250A
 BF115D / DK1 / A2
 BF130 A2



REF	OEM
REC16010-ST5-993	16900-ST5-993



 BF115
 BF130 / AX / AY / A1
 Series #14ZW50E1M



REF	OEM		
RAC025-RAC-02	06176-ZW3-801AH	1/4" 18 NPTF	1/4" 18 NPTF

 BF5
 BF20

REF	OEM
RACS2502	17670-ZW3-801AH

ACEITE OIL OLIO HUILES

REF			
REC2TU6	1 L	6	2 STROKES
REC2TU3	5 L	3	TC-W3
REC5W40U6	1 L	6	SAE 5W40
REC5W40U3	5 L	3	
REC10W30U6	1 L	6	SAE 10W30
REC10W30U3	5 L	3	
REC10W40U6	1 L	6	SAE 10W40
REC10W40U3	5 L	3	
REC25W40U3	5 L	3	SAE 25W40
REC80W90U3	5 L	3	
REC80W90U6	1 L	6	SAE 80W90



REF			
RM92-858026QB1U6	1 L	6	2 STROKES
RM92-858027QB1U3	3,8 L	3	
RM92-8M0086220U6	1 L	6	SAE 10W30
RM92-8M0086221U3	4 L	3	



RM92-858026QB1U6 RM92-858027QB1U3 RM92-8M0086220U6 RM92-8M0086221U3

FILTRO DE ACEITE

OIL FILTER

FILTRO OLIO

FILTRE A HUILE

FILTROS DE ACEITE

OIL FILTER

FILTRO OLIO

FILTRES A HUILE

REF	OEM
REC35-822626Q03	15400-PM3-004
	15400-PFB-014,
	15400-PFRB-007
	15400-ZW4-003
	15400-PJ7-015
	15400-PM3-405
	15400-PFB-004



	BF25DE4	BF15DK3	BF50DK2
	BF30D4	BF20D3	BF50DK4
	BF8B2	BF20DK2	BF8D4
	BF8D2	BF20DK3	BFP10D2
	BF10B2	BF25DK2	
	BF10D2	BF30DK2	
	BF10D4	BF40DK2	
	BF15D3	BF40DK4	

REF	OEM
REC15400-PLM-A01PE	15400-PH1-F03
	15400-POH-305PE
	15400-POH-305
	15400-ZJI-004
	15400-PLM-A01PE
	15400-RTA-003
	15400-RTA-004



	BF100A	BF150AK2	BF200AK2	BF250A	BF90DK0
	BF100AK1	BF175A6	BF200AK3	BF250D	BF90DK2
	BF115A2	BF175AK1	BF200D	BF75DK0	BF90DK4
	BF115D	BF175AK2	BF225A6	BF75DK2	BF90DK5
	BF115DK1	BF175AK3	BF225AK1	BF75DK3	BFT100AK1
	BF135A4	BF175D	BF225AK2	BF75DK4	BFT80AK1
	BF135AK2	BF200A6	BF225AK3	BF80A	
	BF150A4	BF200AK1	BF225D	BF80AK1	

REF	OEM
REC15400-RBA-F01	15400-RBA-F01

	V-TEC150
	V-TEC175



REF	OEM
REC5GH-13440-00	15400-PFB-007

	BF25
	BF30
	BF40



GUÍA FILTROS DE ACEITE

OIL FILTER GUIDE

GUIDA FILTRO OLIO

GUIDE DES FILTRES A HUILE

	REF
BF8B2	REC35-822626Q03
BF8D2	
BF8D4	
BF10B2	
BF10D2	REC35-822626Q03
BF10D4	
BF10D4	
BFP10D2	
BF15D3	REC35-822626Q03
BF15DK3	
BF20D3	
BF20DK2	REC35-822626Q03
BF20DK3	
BF25	REC5GH-13440-00
BF25DE4	REC35-822626Q03
BF25DK2	
BF30	REC5GH-13440-00
BF30D4	REC35-822626Q03
BF30DK2	
BF40	REC5GH-13440-00
BF40DK2	REC35-822626Q03
BF40DK4	

	REF	
BF50DK2	REC35-822626Q03	
BF50DK4		
BF75DK2		
BF75DK3		
BF75DK4	M20 x 1.5	REC15400-PLM-A01PE
BF75DK4		
BF75DK0	M20 x 1.5	REC15400-PLM-A01PE
BF80A		
BF80AK1		
BFT80AK1		
BF90DK2	M20 x 1.5	REC15400-PLM-A01PE
BF90DK4		
BF90DK5		
BF90DK0		
BF100A	M20 x 1.5	REC15400-PLM-A01PE
BF100AK1		
BFT100AK1		
BF115A2		
BF115D	M20 x 1.5	REC15400-PLM-A01PE
BF115DK1		
BF135A4	M20 x 1.5	REC15400-PLM-A01PE
BF135AK2		

	REF	
BF150A4	M20 x 1.5	REC15400-PLM-A01PE
BF150AK2		
BF175A6		
BF175AK1	M20 x 1.5	REC15400-PLM-A01PE
BF175AK2		
BF175AK3		
BF175D		
BF200A6	M20 x 1.5	REC15400-PLM-A01PE
BF200AK1		
BF200AK2		
BF200AK3		
BF200D	M20 x 1.5	REC15400-PLM-A01PE
BF225A6		
BF225AK1		
BF225AK2		
BF225AK3	M20 x 1.5	REC15400-PLM-A01PE
BF225D		
BF250A	M20 x 1.5	REC15400-PLM-A01PE
BF250D		
V-TEC150		
V-TEC175	M20 x 1.5	REC15400-RBA-F01

**BOMBA DE
COMBUSTIBLE
ELECTRICA**

**ELECTRIC
FUEL PUMP**

**POMPA BENZINA
ELETTRICA**

**POMPE À ESSENCE
ÉLECTRIQUE**

REF	OEM
REC16735-ZW5-003	16735-ZW5-003 16735-ZY3-004

 BF100A, AK1
 BTF100AK1
 BF115A1, A2, A3, AX
 BF130A1, A2, AX
 BF135A4, AK2
 BF150A4, AK2
 BF75DK0, DK2, DK3, DK4
 BF90DK0, DK2, DK4, DK5

BF80A, AK1
 BFT80AK1
 BF175D, A3, A6, AK1, AK2, AK3
 BF200D, A2, A3, A6, AK1, AK2, AK3
 DF225D, A2, A3, A6, AK1, AK2, AK3
 BF250D, A

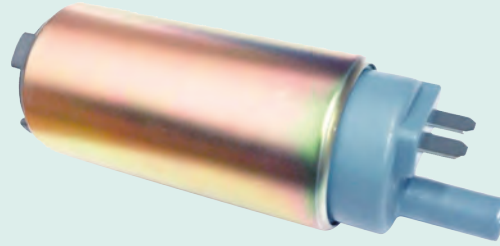

new

INYECTORES

INJEKTOR

INIETTORE

INJECTEURS

INJECTOR

INJEKTOR

INIETTORE

INJECTEURS

REF	OEM
REC06164-PCA-000	16450-ZY6-003

 BF115AX
 BF130AX



new

CARBURADOR

CARBURETOR

CARBURATORE

CARBURATEUR

AGUJA CARBURADOR

**CARBURETOR,
NEEDLE VALVE**

**SPILLO CONICO
CARBURATORE**

POINTEAU CARBURATEUR

REF	OEM
REC16011-881-741	16011-881-741

 BF5 (-2003)
 BF8
 BF75 (-1997)
 BF100 (-1997)



REF	OEM
REC16011-ZV4-005	16011-ZV4-005

 BF8 (2001+)
 BF9.9
 BF15
 BF20 (2003+)
 BF25
 BF30
 BF35 (1997)
 BF40
 BF45 (1997)
 BF50
 BF75 (1997+)
 BF90 (1997+)





KITS CARBURADORES

CARBURETOR KITS



KIT CARBURATORI

KIT CARBURATEUR

REF	OEM
REC06160-ZV4-U11	06160-ZV4-U11 Honda KIT 1
 BF9.9 (2000+) BF15 (2002+)	

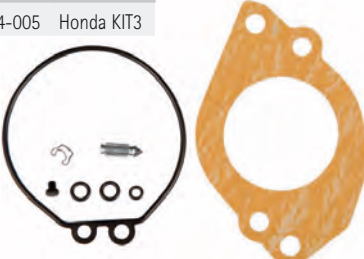
REF	OEM
REC16010-ZW9-003	16010-ZW9-003 Honda KIT2
 BF9.9 (2001+) BF15 (2003+)	

REF	OEM
REC16010-ZV4-005	16010-ZV4-005 Honda KIT3
 BF75 (1997+) BF90 (1997+)	

REF	OEM
REC18-7053	Honda KIT4
 BF8 (1996+) BF75 (1996+) BF100 (1996+)	

GUÍA CARBURADORES

GUIDE CARBURETORS

GUIDA CARBURATORI

GUIDE DES CARBURATEURS

	KIT
BF8C, CX	REC16010-ZV4-005
BF8B1, B2, D1, D2, D3, D4, DK2	REC16010-ZW9-003
BF8 (2001+)	REC18-7053
BFP8B1, B2, D1, D2, D3	REC16010-ZW9-003
BF9.9	REC18-7053
BF9.9AH, AK, AM, AX, AY, B, BX	REC16010-ZV4-005
BF9.9D1, D2, D3, DK2	REC16010-ZW9-003
BFP9.9D, D1, D2	REC16010-ZW9-003
BF10B1, B2, D1, D2, D4, K2	REC16010-ZW9-003
BFP10B1, B2, D1, D2	REC16010-ZW9-003
BF15	REC18-7053
BF15A1, A2, A3	REC06160-ZV4-U11 REC16010-ZV4-005
BF15AH, AM, AX, AY	REC16010-ZV4-005
BF15B, B2, BX	REC16010-ZV4-005
BF15D3, DK2, DK3	REC16010-ZW9-003
BF20 (2003+)	REC18-7053
BF20A, A2, AX	REC16010-ZV4-005

	KIT
BF20D3, DK2, DK3	REC16010-ZW9-003
BF25	REC18-7053
BF25A, A1, A2, A3, AX, D4, DK2	REC16010-ZV4-005
BF30	REC18-7053
BF30A, A1, A2, A3, AX, D4, DK2	REC16010-ZV4-005
BF35 (1997)	REC18-7053
BF35AM	REC16010-ZV4-005
BF40	REC18-7053
BF40A, A1, A2, A3, A4, AX, AY, B, B2, BX	REC16010-ZV4-005
BF45 (1997)	REC18-7053
BF45AM	REC16010-ZV4-005
BF50	REC18-7053
BF50A, A1, A2, A3, A4, AX, AY	REC16010-ZV4-005
BF75 (1997+)	REC18-7053
BF75A1, A2, A3, AT, AV, AX	REC16010-ZV4-005
BF90 (1997+)	REC18-7053
BF90A1, A2, A3, AT, AV, AX	REC16010-ZV4-005



SISTEMA ELÉCTRICO ELECTRIC SYSTEM

SISTEMA ELETTRICO SYSTEME ELECTRIQUE

SENSORES SENSORS SENSORE CAPTEURS

SENSOR MAP MAP SENSOR SENSORE MAP CAPTEUR MAP

REF	OEM
REC37830-PGK-A01	37830-PGK-A01
 BF135A4	
 BF150A4	
 BF175A3, A6	
 BF200A2, A3, A6	
 BF225A2, A3, A6	













new

REF	OEM
REC37830-PNC-003	37830-PNC-003
 BF40DK2, D	
 BF50DK2,D	
 BF75, DK0, DK2	
 BF90DK0, DK2	





new

REF	OEM
REC37830-RNA-A01	37830-RNA-A01
 BF100A, AK1	BF135A4, AK2
 BFT100AK1	BF50D
 BF40E	BF150A4, AK2
 BF80A, AK1	BF175D, AK1, AK2, AK3
 BF75DK3, DK4	BF200D, AK1, AK2, AK3
 BF90DK4, DK5	BF250D, A
 BF60A	
 BF115D, DK1	
 BF40D	

















new

SENSOR POSICIÓN ARBOL DE LEVAS CAMSHAFT SENSOR SENSORE ALBERO A CAME CAPTEUR DE POSITION D'ARBRE A CAMES

REF	OEM
REC37510-PNB-003	37510-PNB-003
 BF115D, DK1	
 BF135A4, AK2	
 BF150A4, AK2	



new

REF	OEM
REC37500-PNB-003	37500-PNB-003
 BF175D	
 BF200D	
 BF225D	
 BF250D	
 BF115D, DK1	
 BF135A4, AK2	
 BF150A4, AK2	
 BF75DK0, DK2	
 BF90DK0, DK2, DK5	
 BF75DK3, DK4	
 BF100A, AK1	
 BF80A, AK1	
 BF60A	
 BF40E	



new

SENSOR POSICIÓN CIGUENAL CRANKSHAFT SENSOR SENSORE ALBERO MOTORE CAPTEUR DE POSITION DU VILEBREQUIN

REF	OEM
REC37840-R70-A01	37840-R70-A01
 BF175D	
 BF200D	
 BF225D	
 BF250D	



new

SENSOR DETONACIÓN

KNOCK SENSOR

SENSORE ANTIDETONAZIONE

CAPTEUR DE CLIQUETIS

REF	OEM
REC30530-P8F-A01	30530-P8F-A01

- BF175A3, A6
- BF200A2, A3, A6
- BF225A2, A3, A6



new

REF	OEM
REC30530-PNA-003	30530-PNA-003

- BF135A4
- BF150A4



new

REF	OEM
REC30530-RNA-A01	30530-RNA-A01

- BF175AK1, AK2, AK3
- BF200AK1, AK2, AK3
- BF225AK1, AK2, AK3
- BF250A



new

SENSOR MAT TEMPERATURA DEL AIRE

SENSOR MAT, AIR TEMPERATURE

SENSORE MAT, TEMPERATURA ARIA

CAPTEUR MAT DE TEMPERATURE D'AIR

REF	OEM
REC37880-PLC-004	37880-PLC-004

- BF115D, DK1
- BF135A4, AK2
- BF150A4, AK2
- BF75DK0, DK2, DK3, DK4
- BF90DK2
- BF80A, AK1
- BFT80AK1
- BF60A, AK1
- BFP60A,
- BF40D, E
- BF50D,
- BF40DK2
- BF50DK2



new

SENSOR OXÍGENO

O2 SENSOR

SENSORE OSSIGENO

CAPTEUR À OXYGENE

REF	OEM
REC35668-ZY6-003	35668-ZY6-003

- BF115D, DK1
- BF135A4, AK2
- BF150A4, AK2,



REF	OEM
REC35655-ZY3-013	35655-ZY3-013

- BF175A3, A6,
- BF200A2, A3, A6
- BF225A2, A3, A6,



REF	OEM
REC35655-ZY9-003	35655-ZY9-003

- BF75DK0, DK2
- BF90DK0, DK2
- BF75DK0, DK2
- BF90DK0, DK2



REF	OEM
REC35655-ZY3-C01	35655-ZY3-C01

- BF250A,
- BF175AK1, AK2, AK3
- BF200AK1, AK2, AK3
- BF225AK1, AK2, AK3,
- BF40D, DK2, DK4
- BF50D, DK2, DK4,



new

SENSOR PRESIÓN DE ACEITE

OIL PRESSURE SENSOR

SENSORE PRESIONE DELL'OLIO

CAPTEUR DE PRESSION D'HUILE

REF	OEM
REC37260-RNA-A01	37260-RNA-A01

- BF175D
- BF200D
- BF225D
- BF250D
- BF115D, DK1,
- BF135A4, AK2
- BF150AK2
- BF75DK3, DK4
- BF90DK4, DK5
- BF100A, AK1
- BF80A, AK1
- BFT100AK1



new

BOBINAS

COILS

BOBINE

BOBINES

REF	OEM
REC30520-PWC-003	30520-PWC-S01





 BF75DK0, DK2, DK3
 BF90DK0, DK2, DK4
 BF100A
 BF80A

REF	OEM
REC30520-PNA-007	30520-PNA-007





 VTEC
 BF135A4
 BF150A4
 BF115D, DK1
 BF135A4, BF150A4,
 BF135AK2, BF150AK2

REF	OEM
REC30580-ZV4-013	30580-ZV4-023





 BF15AH, AK, AM, B, A1, A2, AX, AY, B2, BX, A3
 BF9.9AH, AK, AM, B, AX, AY
 BF8C, CX



REF CHAPROSU



 REF REC004

BUJÍAS

SPARK

CANDELE

BOUGIES

		REF NGK
BF2D	1999	NGKCR5HSB
BF2/A	1984	NGKBMR4A
BF2B		NGKCR5HSB
BF2.3		NGKCR5HSB
BF4.5B		NGKBPR5ES
BF5AK		NGKBPR5ES
BF5	1984	NGKBPR5ES
BF5A		NGKBPR5ES
BF6B	2003	NGKDR4HS
BF6		NGKDR4HS
BF6CH	2004	NGKCR5EH-9
BF7,5	1977	NGKDR5HS
BF8	2001	NGKCR5EH-9
BF8D		NGKCR5EH-9
BF8D1	2001	NGKCR5EH-9
BF8	1987-00	NGKDR5HS
BF8 A/B/C	1990-00	NGKDR5HS
BF8B1		NGKCR5EH-9
BF9/A		NGKDR5HS
BF9.9	1987-01	NGKDR5HS
BF9.9 A/B		NGKDR5HS
BF9.9D1	2001	NGKCR5EH-9
BF10D	2001	NGKCR5EH-9
BF10/B1	2001	NGKCR5EH-9
BF15D	2003	NGKCR5EH-9
BF15B		NGKDR5HS
BF15	1987-90	NGKDR6HS
BF15A	1996-02	NGKDR5HS
BF20	1993	NGKDR7EA
BF20/F	1985	NGKBMR4A
BF20D	2003	NGKCR5EH-9
BF25/A	1993	NGKDR7EA
BF25B		NGKDR7EA

		REF NGK
BF25D4	2004	NGKDR7EA
BF28		NGKCR5HSB
BF28D		NGKCR5HSB
BF30/A	1994	NGKDR7EA
BF30D4	2004	NGKDR7EA
BF35/A	1990	NGKDR7EA
BF40B		NGKDR7EA
BF40/A	1994	NGKDR7EA
BF45/A	1990	NGKDR7EA
BF50/F	1985-94	NGKBPR5ES
BF50	1986-94	NGKBPR5ES
BF50/A	1994	NGKDR7EA
BF60A		NGKLMAR6C-9
BF70A		NGKDR7EA
BF75	2003	NGKDR7EA
BF75B		NGKDR7EA
BF75D		NGKIZFR6K-11E
BF75E		NGKDR5HS
BF75A	1995	NGKDR7EA
BF75		NGKDR5HS
BF90/A	1995	NGKDR7EA
BF90D		NGKIZFR6K-11E
BF100E		NGKDR5HS
BF100		NGKDR5HS
BF115/A	1998	NGKZFR7F
BF130A	1998	NGKZFR7F
BF135A		NGKIZFR6K11
BF150A		NGKIZFR6K11
BF175A		NGKIZFR6K11
BF200A V6	2002	NGKIZFR6K11
BF225A V6	2002	NGKIZFR6K11
BF250A	2010	NGKIZFR6K11



		REF CHAMPION
2HP	BF2A,D	CHACJ14
5HP	OHC - BF5A	CHARN11YC4
7.5HP	B75	CHAP10Y
8.0HP	OHC - BF8A	CHAP10Y
9.9HP	BF9.9A	CHAP10Y
15HP	OHC - BF15A	CHAP8Y
20HP	BF20A	CHARA6HC
25HP	OHC - BF25A	CHARA8HC
30HP	OHC - BF30A	CHARA8HC
35HP	BF35A	CHARA8HC
40HP	OHC - BF40A	CHARA8HC
45HP	BF45A	CHARA8HC
50HP	OHC - BF50A	CHARA8HC
70HP	OHC - BF70A	CHARA8HC
75HP	BF75A	CHARA8HC
90HP	OHC - BF90A	CHARA8HC
115HP	OHC	CHARC9MC4
130HP	OHC	CHARC9MC4
150HP	BF150, BF200, 225	CHARC9MC4



MOTORES DE ARRANQUE



STARTERS

MOTORINI AVVIAMENTO

DEMARREURS



MOTORES DE ARRANQUE

STARTERS

REF	OEM		
REC31200-ZW9-802	31200-ZW9-802 31200-ZW9-801	12V	11 CCW



 BF8B2, D2, D3, D4
BFP8B2, D2, D3, DK2
BF9,9DK2, D3
BF10D4, DK2, 0B2,
BFP10B2, D2,
BFP9,9D3,



REF	OEM		
REC31200-ZY6-003	31200-ZY6-003 31200-ZY9-003 31200-ZY9A-0031	12V 1.00 KW	9 CW



 BF115D, DK1
BF135A4, AK2
BF150A4, AK2
BF75DK0, DK2
BF90DK2, DK0



REF	OEM		
PH130-0064	31200-ZW1-004	12V 1.4 KW	13 CW



 BF75A1, A2, A3, AT, AV, AX,
BF90A1, A2, A3, AT, 90AV, AX



REF	OEM		
PH130-0065	31200-ZW5-003	12V 1.4 KW	13 CW



 BF115A1, A2, A3, AX,
BF130A1, A2, A3, AX,



REF	OEM		
PH130-0054	31200-ZV5-013 31200-ZV5-003	12V 0.9 KW	9 CW

 BF35AM,
BF40B, BX, AX, A1, A2, A3, A4, AY,
BF45AM, A, A1,
BF50A, A1, A2, A3, A4, AX, AY,



REF	OEM		
PH130-0070	31200-ZY3-003 31200-ZY3A-0034	12V 1.7 KW	9 CW

 BF175D, A3, A6, AK1, AK2, AK3
BF200D, A2, A3, A6, AK1, AK2, AK3
BF225D, A2, A3, A6
BF250D, A, AK1, AK2, AK3



GUÍA DE ARRANQUE

STARTER GUIDE

GUIDE AVVIAMENTO

GUIDE DE DÉMARREURS



BF8	2001	REC31200-ZW9-802
BF10	2001	REC31200-ZW9-802
BF9,9	2001	REC31200-ZW9-802
BF35	1995-1997	PH130-0054
BF40	1995	PH130-0054
BF45	1995-1997	PH130-0054
BF50	1995	PH130-0054
BF75	2007	REC31200-ZY6-003
BF75	1997-2006	PH130-0064
BF90	1997-2006	PH130-0064



BF90	2007	REC31200-ZY6-003	
BF115	1999-2006	PH130-0065	REC31630-ZW5-003
BF115	2007	REC31200-ZY6-003	REC31630-ZY6-003
BF130	1999-04	PH130-0065	REC31630-ZW5-003
BF135	2004	REC31200-ZY6-003	REC31630-ZY6-003
BF150	2004	REC31200-ZY6-003	REC31630-ZY6-003
BF175	2002	PH130-0070	REC31630-ZY3-003
BF200	2002	PH130-0070	REC31630-ZY3-003
BF225	2002	PH130-0070	REC31630-ZY3-003
BF250	2012	PH130-0070	REC31630-ZY3-003

DESCONECTORES DE SEGURIDAD

CUT OFF SWITCHES

CHIAVETTA DI SICUREZZA

COUPE CIRCUIT DE SECURITE

DESCONECTOR DE SEGURIDAD

Interruptor de encendido para motores. Aísla los circuitos en unidades dobles para prevenir el retorno al alternador.

IGNITION KILL SWITCHES

Emergency and stop switch. Isolates circuits on dual units to prevent feedback.

INTERRUTTORE DI STOP

Interruttore di accensione per motori. Isola i circuiti in doppie unità per prevenire il ritorno all'alternatore.

COUPE CIRCUIT DE SECURITE

Interruteur d'arrêt d'urgence. Il isole les circuits en double pour éviter le retour à l'alternateur.

REF

THKS-1	Un fueraborda	Single outboard	Un fuoribordo	Un hors-bord	1
THKS-2	Un intraborda	Single I/O	Un entrobordeo	Un inboard	1
THKS-12	Dos fuerabordos	Dual outboard	Due fuoribordo	Deux hors-bord	1
THKS-22	Dos intrabordos	Dual I/O	Due entrobordeo	Deux inboard	1
THL-4	Cuerda recambio	Spare lanyard	Corde ricambio	Cordon de rechange	1



KITS

Interruptor de encendido para todo tipo de motores fueraborda o intraborda

KITS

Emergency and stop switch for inboard or outboards.

KIT

Interruttore di accensione per tutti i tipi di motori fuoribordo o entrobordeo.

KITS

Coupe circuit de sécurité pour moteur inboard ou hors-bord

REF KIT	CUERDA WIRE CORDA CORDON	
REC40970	REC40990	1



REF KIT	CUERDA WIRE CORDA CORDON	
GS11290	GS11291	1



REF KIT	
GS11292	1



REF	
GS11294	1



ALTERNADOR

ALTERNATOR

ALTERNATORE

ALTERNATEUR

ALTERNADOR

ALTERNATOR

ALTERNATORE

ALTERNATEUR

REF	OEM	12V 55A	new
REC31630-ZY6-003	31630-ZY6-003 31630-ZY6-013	REC31638-ZY6-003 4	

BF115D, DK1, BF135A4, AK2, BF150A4, AK2



REF	OEM	6
REC31630-ZY3-003	31630-ZY3-003	REC31638-ZY3-003 6

BF250A, BF175A3, A6, AK1, AK2, AK3, D, BF200A2, A3, A6, AK1, AK2, AK3, D, BF225A2, A3, A6, AK1, AK2, AK3, D, BF250D, A,



REF	OEM	12V 55A CW	new
REC31630-ZW5-003	31630-ZW5-003	4	

BF115A1, A2, A3, AX, BF130A1, A2, A3, A4, AX



CORREAS DE ALTERNADOR

ALTERNATOR BELT

CURROIA ALTERNATORE

COURROIE D'ALTERNATEUR

new

REF	OEM
REC31638-ZY3-003	31638-ZY3-003

 BF175A3, A6, AK1, AK2, AK3, D, BF200A2, A3, A6, AK1, AK2, AK3, D, BF225A2, A3, A6, AK1, AK2, AK3, D, BF250D



new

REF	OEM
REC31638-ZY6-003	31638-ZY6-003

 F115D, BF115D, DK1, BF135A4, AK2, BF150A4, AK2



TRIM, TILT & POWER TRIM

INSTALACIÓN ELÉCTRICA

WIRING HARNESS

INSTALLAZIONE ELETTRICA

INSTALLATION ELECTRIQUE

KIT CONVERSIÓN
Sustituye de 2 a 3 cables.

CONVERSION KIT
Converts 3-wire Tilt and Trim motors to 2-Wire design

KIT CONVERSIONE
Sustituisce da 2 a 3 cavi.

KIT DE CONVERSION.
Passe un faisceau de 2 à 3 fils

REF
PH200-WH01





TRIM COMPLETO

COMPLETE TRIM ASSEMBLY

MOTORINO TRIM COMPLETO



MOTEUR DE TRIM

new

REF	OEM			
PH200-T046	36120-ZV5-822	12V	4	2





 BF40, BF50 (2002-03)





REF	OEM			
PH200-T021	36120-ZV5-821	12V	4	2

 BF35AM, BF40B, B2, BX, A, A1, A2, AX, AY, BF45AM, BF50A, A1, A2, AX, AY



REF	OEM			
REC36120-ZY3-013	36120-ZY3-013	12V	4	

 BF175A3, A6, AK1, AK2, BF200A2, A3, A6, AK2, BF225A2, A3, A6, AK1, AK2,





REF	OEM			
REC36120-ZW4-H12	36120-ZW4-H12	12V	4	

 BF40A4, BF50A4, BF40D, DK2, DK4, BF50D, DK2, DK4





REF	OEM	⚡	🔩	✂️
REC36120-ZY6-013	36120-ZY6-013 36120-ZY6-023	12V	4	

 BF115D, DK1
 BF135A4, AK2
 BF150A4, AK2



REF	OEM	⚡	🔩	✂️
REC36120-ZY9-003	36120-ZY9-003 36120-ZY9-013	12V	4	

 BF75DK0, DK2, DK3
 BF90DK0, DK2, DK4
 BF100A
 BF80A



POWER TRIM COMPLETO **COMPLETE POWER TRIM ASSEMBLY** **MOTORINO POWER TRIM COMPLETO** **POWER TRIM COMPLET**

REF
REC18-6865



 3 RAM
 115-225HP
 BF115+

SHOWA SYSTEM



EXTRACTOR TAPONES TRIM **TRIM PLUGS EXTRACTOR** **ESTRATTORE PER TAPPI DI TRIM** **KIT EXTRACTEUR DE BOUCHONS TRIM** **new**

REF	RECTOOLTRIMKIT	TRIM PISTON	TILT PISTON	🔩
	RECTOOLTRIM1 + RECTOOLTRIM2 + RECTOOLTRIM3	RECTOOLTRIM2	RECTOOLTRIM3	75 --> 225 (1997+)

REF	🔩				A
RECTOOLTRIM1	1/2"	+ RECPIN4	+ RECPIN4.5	38 mm	
RECTOOLTRIM2	1/2"	+ RECPIN4	+ RECPIN4.5	32 mm	
RECTOOLTRIM3	1/2"	+ RECPIN6		35 mm	

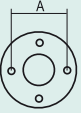
Los pines de repuesto no tienen garantía.
 Replacement pins are not guaranteed.
 I perni di ricambio non sono garantiti.
 Les pins de remplacement ne sont pas garanties

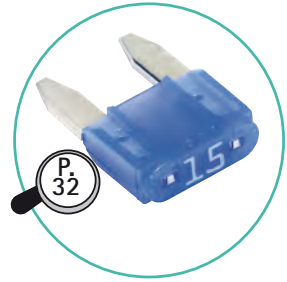

SISTEMA DE GOBIERNO STEERING SYSTEM

SISTEMA DI GUIDA SYSTÈME DE COMMANDE

MANDOS DE CONTROL

ENGINE CONTROLS

COMANDI DI CONTROLLO

BOITIER DE COMMANDE

MANDO LATERAL

SIDE CONTROL

COMANDO LATERALE

BOITIER LATERAL

REF	OEM	POWER TRIM
REC24800-ZZ5-A02	24800-ZZ5-A02 24800-ZZ5-A01 24800-ZZ5-A22	✓

RECMAR[®]

(NHK MEC) BF40 --> BF250
EFI
4 LED



MANDO PARA CONSOLA

CONSOLE CONTROL

COMANDO PER CONSOLLA

BOITIER POUR CONSOLE

REF	RO OEM	TRIM TILT
REC06240-ZW5-U40	06240-ZW5-U40 06240-ZW5-U001	✓

REF	RO OEM	TRIM TILT
REC06240-ZW5-U60	06240-ZW5-U60	✓

BF40 --> BF250

RECMAR[®]



LLAVES ARRANQUE IGNITION STARTER SWITCH

CHIAVI DI ACCENSIONE

CONTACTEUR A CLÉ

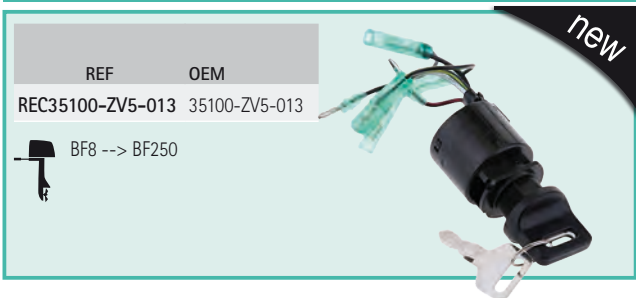

CABLES DE CONTROL

CONTROL CABLES

CAVI COMANDO

CÂBLES DE COMMANDE

Recorrido trabajo: 76 mm.
Rosca 10-32"

Travel 3"
Threaded 10-32"

Estensione 76 mm
Filetto 10-32"

Course: 76 mm.
Fil 10-32

REF	RO	
PRE3300C05	24911-ZW7-U01	5' / 1,52 m
PRE3300C06	24912-ZW7-U01	6' / 1,83 m
PRE3300C07	24913-ZW7-U01	7' / 2,13 m
PRE3300C08	24914-ZW7-U01	8' / 2,45 m
PRE3300C09	24915-ZW7-U01	9' / 2,75 m
PRE3300C10	24916-ZW7-U01	10' / 3,05 m
PRE3300C11	24917-ZW7-U01	11' / 3,35 m
PRE3300C12	24918-ZW7-U01	12' / 3,65 m
PRE3300C13	24919-ZW7-U01	13' / 3,95 m
PRE3300C14	24920-ZW7-U01	14' / 4,25 m
PRE3300C15	24921-ZW7-U01	15' / 4,60 m
PRE3300C16	24922-ZW7-U01	16' / 4,90 m
PRE3300C17	24923-ZW7-U01	17' / 5,20 m
PRE3300C18	24924-ZW7-U01	18' / 5,50 m
PRE3300C19	24925-ZW7-U01	19' / 5,80 m
PRE3300C20	24926-ZW7-U01	20' / 6,10 m
PRE3300C21	24927-ZW7-U01	21' / 6,40 m
PRE3300C22	24928-ZW7-U01	22' / 6,70 m
PRE3300C23	24929-ZW7-U01	23' / 7,00 m
PRE3300C24	24930-ZW7-U01	24' / 7,30 m
PRE3300C25	24931-ZW7-U01	25' / 7,60 m
PRE3300C26	24932-ZW7-U01	26' / 7,90 m
PRE3300C27	24933-ZW7-U01	27' / 8,25 m
PRE3300C28	24934-ZW7-U01	28' / 8,55 m
PRE3300C29	24935-ZW7-U01	29' / 8,85 m
PRE3300C30	24936-ZW7-U01	30' / 9,15 m
PRE3300C31	24937-ZW7-U01	31' / 9,45 m
PRE3300C32	24938-ZW7-U01	32' / 9,75 m



maxflex



HONDA

RECAMBIOS MARINOS

SISTEMA DE REFRIGERACIÓN COOLING SYSTEM

SISTEMA DI RAFFREDDAMENTO SYSTÈME DE REFROIDISSEMENT

TERMOSTATO

THERMOSTAT

TERMOSTATO

THERMOSTAT

TERMOSTATOS

THERMOSTATS

TERMOSTATO

THERMOSTATS

REF	OEM	°C
REC19300-881-761	19300-881-761	52°C



BF4.5B, BX, BK2, B2, B4, B6, BKO
BF5AH, AK, AM, AX, AK2, A2, A3, A4
BF15AH, AK, AM, B, A1, A2, A3, AX, AY, B2, BX
F6B, BX
BF8AX, B, BX, C, CX, AH, AK, AM
BF100F
BF75F
BF9.9AH, AK, AM, B, AX, BX, AY



REF	OEM	°C
PAF15-07000031	19300-ZW9-003 19300-881-741 19300-921-003	60°C



BF25D4, DK2
BF30D4, DK2
BF40A, D, DK2, E
BF50A, D, DK2
BF8B1, B2, D1, D2, DK2, D3, D4
BF9.9DK2, D1, D2, D3
BF10B1, B1, D4, DK2, B2, D2
BF15D3, DK2
BF20D3

BF200A
BF225A
BF75DK0, DK2, DK3
BF90DK0, DK2, DK4
BF100A
BF80A
BF60A, AK1



REF	OEM	°C
REC67F-12411-01	19300-ZX2-003	60°C



BF175D,
BF200D,
BF225D,
BF250A, D



new

REF	OEM	°C
REC19300-ZV5-043	19300-ZV5-003, 19300-ZV5-013, 19300-ZV5-023, 19300-ZV5-033, 19300-ZV5-043	72°C



BF35AM
BF40B, B2, BX, AX, A1, A2,
A3, AY
BF45AM
BF20AX, A
BF25A, A1, AX
BF30A, A1, AX, A2, A3

BF75A1, AT, AV, AX, A2, A3
BF90A1, AT, AV, AX, A2, A3
BF115A1, A2, AX
BF130A1, A2, AX
BF50A2, AX, A1, A3, AY
BF20A2, A3
BF25A1, A2, A3

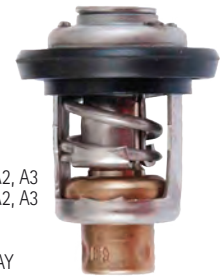

REF	OEM	°C
REC6E5-12411-30	19300-ZY6-003	50°C



BF75DK0, DK2, DK3, DK4
BF80A, AK1
BF90DK0, DK2, DK4, DK5
BF100A, AK1
BF115D, DK1
BF135A4, AK2
BF150A4, AK2
BFT80AK1
BFT100AK1



new

REF	OEM	°C
REC6AH-12411-00	19300-ZY3-023	60°C



BF115A2, A3, D, DK1,
BF130A2, A3,
BF135A4, AK2,
BF150A4, AK2,
BF175A3, A6, AK1, AK2, AK3,
BF200A2, A3, A6, AK1, AK2, AK3,
BF225A2, A3, A6, AK1, AK2, K3,



new

GUÍA TERMOSTATO

THERMOSTAT GUIDE

GUIDA TERMOSTATO

GUIDE DES THERMOSTATS

Icon	REF
	B75K2 PAF15-07000031
	B75K3 PAF15-07000031
	BD115DK1 REC6E5-12411-30
	BD130A2 REC19300-ZV5-043
	BF100A PAF15-07000031
	BF100A PAF15-07000031
	BF100A REC6E5-12411-30
	BF100AK1 PAF15-07000031
	BF100AK1 REC6E5-12411-30
	BF100B PAF15-07000031
	BF100C PAF15-07000031
	BF100D PAF15-07000031
	BF100E PAF15-07000031
	BF100F PAF15-07000031
	BF100F REC19300-881-761
	BF10B1 PAF15-07000031
	BF10B2 PAF15-07000031
	BF10D1 PAF15-07000031

Icon	REF
	BF10D2 PAF15-07000031
	BF10D4 PAF15-07000031
	BF10DK2 PAF15-07000031
	BF115A1 REC19300-ZV5-043
	BF115A2 REC19300-ZV5-043
	BF115A2 REC6AH-12411-00
	BF115A3 REC6AH-12411-00
	BF115D REC6AH-12411-00
	BF115D REC6E5-12411-30
	BF115DK1 REC6AH-12411-00
	BF130A1 REC19300-ZV5-043
	BF130A2 REC6AH-12411-00
	BF130A3 REC6AH-12411-00
	BF130AX REC19300-ZV5-043
	BF135A4 REC6AH-12411-00
	BF135A4 REC6E5-12411-30
	BF135AK2 REC6AH-12411-00
	BF135AK2 REC6E5-12411-30

Icon	REF
	BF150A4 REC6AH-12411-00
	BF150A4 REC6E5-12411-30
	BF150AK2 REC6AH-12411-00
	BF150AK2 REC6E5-12411-30
	BF15A1 REC19300-881-761
	BF15A2 REC19300-881-761
	BF15A3 REC19300-881-761
	BF15AH REC19300-881-761
	BF15AK REC19300-881-761
	BF15AM REC19300-881-761
	BF15AX REC19300-881-761
	BF15AY REC19300-881-761
	BF15B2 REC19300-881-761
	BF15BX REC19300-881-761
	BF15D3 PAF15-07000031
	BF15DK2 PAF15-07000031
	BF15DK3 PAF15-07000031
	BF175A3 REC6AH-12411-00

Icon	REF
	BF175A6 REC6AH-12411-00
	BF175AK1 REC6AH-12411-00
	BF175AK2 REC6AH-12411-00
	BF175AK3 REC6AH-12411-00
	BF175D REC67F-12411-01
	BF200A2 PAF15-07000031
	BF200A2 REC6AH-12411-00
	BF200A3 REC6AH-12411-00
	BF200A6 REC6AH-12411-00
	BF200AK1 REC6AH-12411-00
	BF200AK2 REC6AH-12411-00
	BF200AK3 REC6AH-12411-00
	BF200D REC67F-12411-01
	BF20A REC19300-ZV5-043
	BF20A2 REC19300-ZV5-043
	BF20AX REC19300-ZV5-043
	BF20D3 PAF15-07000031
	BF20DK2 PAF15-07000031

HONDA

RECAMBIOS MARINOS









	REF
BF20DK3	PAF15-07000031
BF225A2	PAF15-07000031
BF225A2	REC6AH-12411-00
BF225A3	REC6AH-12411-00
BF225A6	REC6AH-12411-00
BF225AK1	REC6AH-12411-00
BF225AK2	REC6AH-12411-00
BF225AK3	REC6AH-12411-00
BF225D	REC67F-12411-01
BF250A	REC67F-12411-01
BF250D	REC67F-12411-01
BF25A	REC19300-ZV5-043
BF25A1	REC19300-ZV5-043
BF25A2	REC19300-ZV5-043
BF25A3	REC19300-ZV5-043
BF25AX	REC19300-ZV5-043
BF25D4	PAF15-07000031
BF25DK2	PAF15-07000031
BF30A	REC19300-ZV5-043
BF30A1	REC19300-ZV5-043
BF30A2	REC19300-ZV5-043
BF30A3	REC19300-ZV5-043
BF30AX	REC19300-ZV5-043
BF30D4	PAF15-07000031
BF30DK2	PAF15-07000031
BF35AM	REC19300-ZV5-043
BF4,5B	REC19300-881-761
BF4,5B2	REC19300-881-761
BF4,5B4	REC19300-881-761
BF4,5B6	REC19300-881-761
BF4,5BK0	REC19300-881-761
BF4,5BK2	REC19300-881-761
BF4,5BX	REC19300-881-761
BF4,9BH	REC19300-881-761
BF40A	REC19300-ZV5-043
BF40A1	REC19300-ZV5-043
BF40A2	REC19300-ZV5-043
BF40A3	REC19300-ZV5-043
BF40A4	PAF15-07000031
BF40AX	REC19300-ZV5-043
BF40AY	REC19300-ZV5-043

	REF
BF40B	REC19300-ZV5-043
BF40B2	REC19300-ZV5-043
BF40BX	REC19300-ZV5-043
BF40D	PAF15-07000031
BF40DK2	PAF15-07000031
BF40DK4	PAF15-07000031
BF40E	PAF15-07000031
BF45AM	REC19300-ZV5-043
BF4AH	REC19300-881-761
BF50A	REC19300-ZV5-043
BF50A1	REC19300-ZV5-043
BF50A2	REC19300-ZV5-043
BF50A3	REC19300-ZV5-043
BF50A4	PAF15-07000031
BF50AX	REC19300-ZV5-043
BF50AY	REC19300-ZV5-043
BF50D	PAF15-07000031
BF50DK2	PAF15-07000031
BF50DK4	PAF15-07000031
BF50F	REC19300-881-761
BF5A1	REC19300-881-761
BF5A2	REC19300-881-761
BF5A3	REC19300-881-761
BF5A4	REC19300-881-761
BF5AH	REC19300-881-761
BF5AK	REC19300-881-761
BF5AK2	REC19300-881-761
BF5AM	REC19300-881-761
BF5AX	REC19300-881-761
BF5DH	REC19300-881-761
BF60A	PAF15-07000031
BF60AK1	PAF15-07000031
BF6AH	REC19300-881-761
BF6B	REC19300-881-761
BF6BX	REC19300-881-761
BF6D6	PAF15-07000031
BF75A	PAF15-07000031
BF75A1	REC19300-ZV5-043
BF75A2	REC19300-ZV5-043
BF75A3	REC19300-ZV5-043
BF75AT	REC19300-ZV5-043

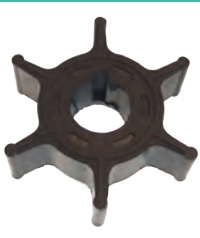
	REF
BF75AV	REC19300-ZV5-043
BF75AX	REC19300-ZV5-043
BF75B	PAF15-07000031
BF75C	PAF15-07000031
BF75D	PAF15-07000031
BF75D	PAF15-07000031
BF75DK0	REC6E5-12411-30
BF75DK2	PAF15-07000031
BF75DK2	REC6E5-12411-30
BF75DK3	PAF15-07000031
BF75DK3	REC6E5-12411-30
BF75DK4	PAF15-07000031
BF75DK4	REC6E5-12411-30
BF75DK0	PAF15-07000031
BF75E	PAF15-07000031
BF75F	PAF15-07000031
BF75F	REC19300-881-761
BF80A	PAF15-07000031
BF80A	REC6E5-12411-30
BF80AK1	PAF15-07000031
BF80AK1	REC6E5-12411-30
BF8AH	PAF15-07000031
BF8AH	REC19300-881-761
BF8AK	REC19300-881-761
BF8AM	PAF15-07000031
BF8AM	REC19300-881-761
BF8AX	REC19300-881-761
BF8B	REC19300-881-761
BF8B1	PAF15-07000031
BF8B2	PAF15-07000031
BF8BX	REC19300-881-761
BF8C	REC19300-881-761
BF8CX	REC19300-881-761
BF8D1	PAF15-07000031
BF8D2	PAF15-07000031
BF8D3	PAF15-07000031
BF8D4	PAF15-07000031
BF9,9AH	REC19300-881-761
BF9,9AK	REC19300-881-761
BF9,9AM	REC19300-881-761
BF9,9AX	REC19300-881-761

	REF
BF9,9AY	REC19300-881-761
BF9,9B	REC19300-881-761
BF9,9BX	REC19300-881-761
BF9,9D1	PAF15-07000031
BF9,9D2	PAF15-07000031
BF9,9D3	PAF15-07000031
BF9,9DK2	PAF15-07000031
BF90A1	REC19300-ZV5-043
BF90A2	REC19300-ZV5-043
BF90A3	REC19300-ZV5-043
BF90AT	REC19300-ZV5-043
BF90AV	REC19300-ZV5-043
BF90AX	REC19300-ZV5-043
BF90DK2	PAF15-07000031
BF90DK2	REC6E5-12411-30
BF90DK4	PAF15-07000031
BF90DK4	REC6E5-12411-30
BF90DK5	PAF15-07000031
BF90DK0	PAF15-07000031
BF90DK0	REC6E5-12411-30
BF990DK5	REC6E5-12411-30
BFDK2	PAF15-07000031
BF10B1	PAF15-07000031
BFP10B2	PAF15-07000031
BFP10D1	PAF15-07000031
BFP10D2	PAF15-07000031
BFP60A	PAF15-07000031
BFP60AK1	PAF15-07000031
BFP8B1	PAF15-07000031
BFP8B2	PAF15-07000031
BFP8D2	PAF15-07000031
BFP8D3	PAF15-07000031
BFP9,9D1	PAF15-07000031
BFP9,9D2	PAF15-07000031
BFP9,9D3	PAF15-07000031
BFPD1	PAF15-07000031
BFT100AK1	PAF15-07000031
BFT100AK1	REC6E5-12411-30
BFT80AK1	PAF15-07000031
BFT80AK1	REC6E5-12411-30

IMPULSORES IMPELLERS GIRANTE TURBINES

IMPULSORES	IMPELLER	GIRANTE	TURBINES								
<table border="1"> <thead> <tr><th>REF</th><th>OEM</th></tr> </thead> <tbody> <tr><td>REC19210-ZV4-651</td><td>19210-ZV4-651</td></tr> </tbody> </table>  <p>BF8C, CX BF9,9AM, AX, B, BX BF15A1, A2, A3, AM, AX, AY, B, B2, BX</p>	REF	OEM	REC19210-ZV4-651	19210-ZV4-651		<table border="1"> <thead> <tr><th>REF</th><th>OEM</th></tr> </thead> <tbody> <tr><td>REC19210-ZW9-013</td><td>19210-ZW9-013 19210-ZW9-003</td></tr> </tbody> </table>  <p>BF8B1, B2, D1, D2, D3, D4, DK2 BF9,9D1, D2, D3, DK2 BF10B1, B2, D1, D2, D4, DK2 BFP8B1, B2, D1, D2, D3 BFP9,9D1, D2, D3 BFP10B1, B2, D1, D2</p>	REF	OEM	REC19210-ZW9-013	19210-ZW9-013 19210-ZW9-003	
REF	OEM										
REC19210-ZV4-651	19210-ZV4-651										
REF	OEM										
REC19210-ZW9-013	19210-ZW9-013 19210-ZW9-003										
<table border="1"> <thead> <tr><th>REF</th><th>OEM</th></tr> </thead> <tbody> <tr><td>REC47-43026Q02</td><td>19210-ZW1-303</td></tr> </tbody> </table>  <p>BF75 BF90AT</p>	REF	OEM	REC47-43026Q02	19210-ZW1-303		<table border="1"> <thead> <tr><th>REF</th><th>OEM</th></tr> </thead> <tbody> <tr><td>REC19210-ZV4-013</td><td>19210-ZV4-013</td></tr> </tbody> </table>  <p>BF9,9AH, AK, AM BF15AH, AK, AM</p>	REF	OEM	REC19210-ZV4-013	19210-ZV4-013	
REF	OEM										
REC47-43026Q02	19210-ZW1-303										
REF	OEM										
REC19210-ZV4-013	19210-ZV4-013										
<table border="1"> <thead> <tr><th>REF</th><th>OEM</th></tr> </thead> <tbody> <tr><td>REC19210-ZY9-H01</td><td>19210-ZY9-H01</td></tr> </tbody> </table>  <p>F75DK3, DK4 BF80A, AK1 BF90DK4, DK5 BF100A, AK1</p>	REF	OEM	REC19210-ZY9-H01	19210-ZY9-H01		<table border="1"> <thead> <tr><th>REF</th><th>OEM</th></tr> </thead> <tbody> <tr><td>REC19210-ZV7-003</td><td>19210-ZV7-003</td></tr> </tbody> </table>  <p>BF20A, A2, AX BF25A, A1, A2, A3, AX, D4, DK2 BF30A, A1, A2, A3, AX, D4, DK2</p>	REF	OEM	REC19210-ZV7-003	19210-ZV7-003	
REF	OEM										
REC19210-ZY9-H01	19210-ZY9-H01										
REF	OEM										
REC19210-ZV7-003	19210-ZV7-003										

REF	OEM
REC19210-881-003	19210-881-003 19210-881-A01 19210-881-A02



 BF4,5B, B2, B4, B6, BK0, BK2, BX
 BF5A1, A2, A3, A4, AH, AK, AK2, AX
 BF6B, BZ, D6
 BF8AH, AK, AM, AX, B, BX
 BF50F
 BF75A, B, C, D, E
 BF100A, B, C, D, E, F

REF	OEM
REC19210-ZW9-A32	19210-ZW9-A31, 19210-ZW9-A32



 BF8B1, B2, D1, D2, D3
 BF9,9DK2
 BF10D2, D4, DK2
 BF15D3, DK2, DK3
 BF20D3, DK2, DK3
 BFP8B1, B2, D1, D2, D3
 BFP9,9D, D1, D2
 BFP10B1, B2, D1, D2

REF	OEM
REC19210-ZY3-003	19210-ZY3-003



 BF175A3, A6, AK1, AK2, AK3, D
 BF200A2, A3, A6, AK1, AK2, AK3, D
 BF225A, A2, A, A6, AK1, AK2, D
 BF250A, D

REF	OEM
REC19210-ZV5-003	19210-ZV5-003



 BF35AM
 BF40A, A1, A2, A3, A4, AX, AY, B,
 B2, BX, D, DK2, DK4, E
 BF45AM
 BF50A, A1, A2, A3, AX, AY, D, DK2,
 DK4
 BF60A, AK1
 BFP60A, AK1

REF	OEM
REC19210-ZW1-B02	19210-ZW1-B02 19210-ZW1-B03 19210-ZW1-B04



 BF75A1, A2, A3, AV, AX, DK0, DK2
 BF90A1, A2, A3, AV, AX, DK0, DK2
 BF115A1, A2, A3, AX, D, DK1
 BF130A1, A2, A3, AX
 BF135A4, AK2
 BF150A4

GUÍA DE IMPULSORES

IMPELLER GUIDE





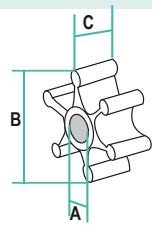

GUIDA GIRANTE



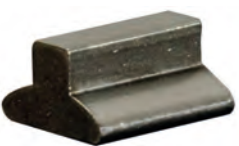





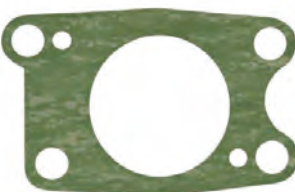

GUIDE DES TURBINES

	REF	CEF	A (mm)	B (mm)	C (mm)	
	BF100A, AK1	REC19210-ZY9-H01				
	BF100A, B, C, D, E, F	REC19210-881-003				
	BF10B1, B2, D1, D2, D4, DK2	REC19210-ZW9-013	CEF500347	13	45,6	14,8
	BF10D2, D4, DK2	REC19210-ZW9-A32	CEF500348	16,2	45,6	14,8
	BF115A1, A2, A3, AX	REC19210-ZW1-B02	CEF500337	23,35	87,8	31
	BF115D, DK1	REC19210-ZW1-B02	CEF500337	23,35	87,8	31
	BF130A1, A2, A3, AX	REC19210-ZW1-B02	CEF500337	23,35	87,8	31
	BF135A4, AK2	REC19210-ZW1-B02	CEF500337	23,35	87,8	31
	BF150A4	REC19210-ZW1-B02	CEF500337	23,35	87,8	31
	BF15A1, A2, A3, AM, AX, AY, B, B2, BX	REC19210-ZV4-651	CEF500343	14,1	41	27,55
	BF15AH, AK, AM	REC19210-ZV4-013	CEF500328	14,2	41	27,55
	BF15D3, DK2, DK3	REC19210-ZW9-A32	CEF500348	16,2	45,6	14,8
	BF175A3, A6, AK1, AK2, AK3, D	REC19210-ZY3-003	CEF500391	26	89,75	31,3
	BF200A2, A3, A6, AK1, AK2, AK3, D	REC19210-ZY3-003	CEF500391	26	89,75	31,3
	BF20A, A2, AX	REC19210-ZV7-003	CEF500339	17,2	55,75	20,2
	BF20D3, DK2, DK3	REC19210-ZW9-A32	CEF500348	16,2	45,6	14,8
	BF20F	RM19211-ZV0-003		10,5	40	22,5
	BF225A, A2, A3, A6, AK1, AK2, D	REC19210-ZY3-003	CEF500391	26	89,75	31,3
	BF250A, D	REC19210-ZY3-003	CEF500391	26	89,75	31,3
	BF25A, A1, A2, A3, AX, D4, DK2	REC19210-ZV7-003	CEF500339	17,2	55,75	20,2
	BF2AH, AK, AM	RM19211-ZV0-003		10,5	40	22,5
	BF30A, A1, A2, A3, AX, D4, DK2	REC19210-ZV7-003	CEF500339	17,2	55,75	20,2
	BF35AM	REC19210-ZV5-003	CEF500338	17,2	55,9	20,2
	BF4,5B, B2, B3, B6, BK0, BK2, BX	REC19210-881-003				
	BF40A, A1, A2, A3, A4, AX, AY, B, B2, BX, D, DK2, DK4, E	REC19210-ZV5-003	CEF500338	17,2	55,9	20,2
	BF45AM	REC19210-ZV5-003	CEF500338	17,2	55,9	20,2
	BF50A, A1, A2, A3, AX, AY, D, DK4	REC19210-ZV5-003	CEF500338	17,2	55,9	20,2
	BF50F, A1, A2, A3, A4, AH, AK, AK2, AX	REC19210-881-003				
	BF60A, AK1	REC19210-ZV5-003	CEF500338	17,2	55,9	20,2
	BF6B, BZ, D6	REC19210-881-003				
	BF75	REC47-43026Q02	CEF500301	22,4	89	32,5
	BF75A	REC19210-881-003				



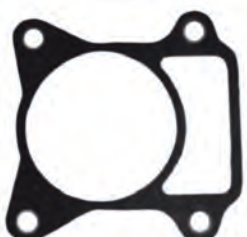

	REF	CEF	A (mm)	B (mm)	C (mm)	
	BF75A1, A2, A3, AV, AX, DK0, DK2, DK3, DK4	REC19210-ZW1-B02	CEF500337	23,35	87,8	31
	BF75B, C, D, E	REC19210-881-003				
	BF80A, AK1	REC19210-ZY9-H01				
	BF8AH, AK, AM, AX, B	REC19210-881-003				
	BF8B1, B2	REC19210-ZW9-013	CEF500347	13	45,6	14,8
	BF8B1, B2	REC19210-ZW9-A32	CEF500348	16,2	45,6	14,8
	BF8BX	REC19210-881-003				
	BF8C, CX	REC19210-ZV4-651	CEF500343	14,1	41	27,55
	BF8D1, D2, D3, D4, DK2	REC19210-ZW9-013	CEF500347	13	45,6	14,8
	BF8D1, D2, D3	REC19210-ZW9-A32	CEF500348	16,2	45,6	14,8
	BF9,9AH, AK, AM	REC19210-ZV4-013	CEF500328	14,2	41	27,55
	BF9,9AM, AX, B, BX	REC19210-ZV4-651	CEF500343	14,1	41	27,55
	BF9,9D1, D2, D3, DK2	REC19210-ZW9-013	CEF500347	13	45,6	14,8
	BF9,9DK2	REC19210-ZW9-A32	CEF500348	16,2	45,6	14,8
	BF90A1, A2, A3	REC19210-ZW1-B02	CEF500337	23,35	87,8	31
	BF90AT	REC47-43026Q02	CEF500301	22,4	89	32,5
	BF90AV, AX, DK0, DK2	REC19210-ZW1-B02	CEF500337	23,35	87,8	31
	BF90DK4, DK5	REC19210-ZY9-H01				
	BFP10B1, B2, D1, D2	REC19210-ZW9-013	CEF500347	13	45,6	14,8
	BFP10B1, B2, D2	REC19210-ZW9-A32	CEF500348	16,2	45,6	14,8
	BFP60A, AK1	REC19210-ZV5-003	CEF500338	17,2	55,9	20,2
	BFP8B1, B2, D1, D2, D3	REC19210-ZW9-013	CEF500347	13	45,6	14,8
	BFP8B1, B2, D1, D2, D3	REC19210-ZW9-A32	CEF500348	16,2	45,6	14,8
	BFP9,9D, D1, D2	REC19210-ZW9-A32	CEF500348	16,2	45,6	14,8
	BFP9,9D1, D2, D3	REC19210-ZW9-013	CEF500347	13	45,6	14,8
	BFPD1	REC19210-ZW9-A32	CEF500348	16,2	45,6	14,8
	BFT100AK1	REC19210-ZY9-H01				
	BFT80AK1	REC19210-ZY9-H01				

CHAVETA		KEY	CIAVETTA		CLAVETTE						
<table border="1"> <thead> <tr> <th>REF</th> <th>OEM</th> </tr> </thead> <tbody> <tr> <td>REC90752-ZV4-650</td> <td>90752-ZV4-650</td> </tr> </tbody> </table> <p>  BF8C, CX BF9.9AM, B, AX, BX, AY BF15AM, B, A1, A2, AX, B2, BX, A3, AY </p>	REF	OEM	REC90752-ZV4-650	90752-ZV4-650		<table border="1"> <thead> <tr> <th>REF</th> <th>OEM</th> </tr> </thead> <tbody> <tr> <td>REC90752-ZV5-003</td> <td>90752-ZV5-003</td> </tr> </tbody> </table> <p>  BF60A, AK1 BF50A4, D, DK2, A, A1, A2, AX, A3, AY BF35AM BF40B, B2, BX, D, DK2, A, A1, A2, AX, E, A3, AY, A4 BF45AM </p>	REF	OEM	REC90752-ZV5-003	90752-ZV5-003	
REF	OEM										
REC90752-ZV4-650	90752-ZV4-650										
REF	OEM										
REC90752-ZV5-003	90752-ZV5-003										
<table border="1"> <thead> <tr> <th>REF</th> <th>OEM</th> </tr> </thead> <tbody> <tr> <td>REC90752-ZV7-000</td> <td>90752-ZV7-000</td> </tr> </tbody> </table> <p>  BF25D4, DK2, A, A1, AX, A2, A3 BF30D4, DK2, A, A1, AX, A2, A3 BF20A, AX, A2 </p>	REF	OEM	REC90752-ZV7-000	90752-ZV7-000		<table border="1"> <thead> <tr> <th>REF</th> <th>OEM</th> </tr> </thead> <tbody> <tr> <td>REC90752-ZY3-003</td> <td>90752-ZY3-003</td> </tr> </tbody> </table> <p>  BF225A2, A3, A6, AK2, AK3 BF175A3, A6, AK1, AK2, AK3 BF200A2, A3, A6, AK1, AK2, AK3 BF250A, AK1 </p>	REF	OEM	REC90752-ZY3-003	90752-ZY3-003	
REF	OEM										
REC90752-ZV7-000	90752-ZV7-000										
REF	OEM										
REC90752-ZY3-003	90752-ZY3-003										
<table border="1"> <thead> <tr> <th>REF</th> <th>OEM</th> </tr> </thead> <tbody> <tr> <td>REC90752-ZW1-B02</td> <td>90752-ZW1-B02 9075-ZW1-003</td> </tr> </tbody> </table> <p>  BF80A, BF100A BF150A4, AK2 BF75A1, AV, AX, DK2, DK3, A2, A3 BF90A1, AV, AX, DK0, DK2, DK4, A2, A3 BF115A1, A2, A3, AX, D, DK1 BF130A1, A2, A3, AX BF135A4, AK2 </p>	REF	OEM	REC90752-ZW1-B02	90752-ZW1-B02 9075-ZW1-003							
REF	OEM										
REC90752-ZW1-B02	90752-ZW1-B02 9075-ZW1-003										

BOMBA DE AGUA		WATER PUMP	POMPA ACQUA		POMPE À EAU								
JUNTAS BOMBA	WATER PUMP GASKET	GUARNIZIONE POMPA	JOINTS DE POMPE A EAU										
<table border="1"> <thead> <tr> <th>REF</th> <th>OEM</th> </tr> </thead> <tbody> <tr> <td>REC8172761</td> <td>19231-ZW1-003</td> </tr> </tbody> </table> <p>  BF75A BF90A </p>	REF	OEM	REC8172761	19231-ZW1-003		<table border="1"> <thead> <tr> <th>REF</th> <th>OEM</th> </tr> </thead> <tbody> <tr> <td>REC19232-ZV1-A10</td> <td>19232-ZV1-A10</td> </tr> </tbody> </table> <p>  BF4.5B, BX, BK2, B2, B4, B6, BK0 BF5A1, AM, AX, AK2, A2, A3, A4 </p>	REF	OEM	REC19232-ZV1-A10	19232-ZV1-A10			
REF	OEM												
REC8172761	19231-ZW1-003												
REF	OEM												
REC19232-ZV1-A10	19232-ZV1-A10												
<table border="1"> <thead> <tr> <th>REF</th> <th>OEM</th> </tr> </thead> <tbody> <tr> <td>REC19232-881-850</td> <td>19232-881-850</td> </tr> </tbody> </table> <p>  BF6B, BX, D6 BF8AX, B, BX, AK, AM </p>	REF	OEM	REC19232-881-850	19232-881-850		<table border="1"> <thead> <tr> <th>REF</th> <th>OEM</th> </tr> </thead> <tbody> <tr> <td>REC19242-ZV5-000</td> <td>19242-ZV5-000</td> </tr> </tbody> </table> <p>  BF20A, AX, A2 BF35AM BF40B, B2, BX, A4, D, DK2, AA1, A2, AX, A3, AY BF45AM BF25D4, DK2, A, A1, AX, A2, A3 BF50A4, D, DK2, A, A1, A2, A3, AY BF30D4, DK2, A, A1, AX, A2, A3 </p>	REF	OEM	REC19242-ZV5-000	19242-ZV5-000			
REF	OEM												
REC19232-881-850	19232-881-850												
REF	OEM												
REC19242-ZV5-000	19242-ZV5-000												
<table border="1"> <thead> <tr> <th>REF</th> <th>OEM</th> </tr> </thead> <tbody> <tr> <td>REC19234-881-850</td> <td>19234-881-850</td> </tr> </tbody> </table> <p>  BF6B, BX, D6 BF8AX, B, BX, AK, AM </p>	REF	OEM	REC19234-881-850	19234-881-850		<table border="1"> <thead> <tr> <th>REF</th> <th>OEM</th> </tr> </thead> <tbody> <tr> <td>REC27-430331</td> <td>19234-ZW1-003</td> </tr> </tbody> </table> <p>  BF75A BF90A </p>	REF	OEM	REC27-430331	19234-ZW1-003			
REF	OEM												
REC19234-881-850	19234-881-850												
REF	OEM												
REC27-430331	19234-ZW1-003												

REF	OEM
REC27-430472	19242-ZW1-003
	BF75A BF90A





REF	OEM
REC19234-ZY3-000	19234-ZY3-000
	BF175A3, A6, AK1, AK2, AK3 BF200A2, A3, A6, AK1, AK2, AK3 BF225A2, A3, A6, AK1, AK2, AK3



REF	OEM
REC19232-ZV4-610	19232-ZV4-610
	BF15AK, AM, B, A1, A2, AX, B2, BX, A1, A2, A3, AY BF9.9AK, AM, B, AX, BX, AY BF8C, CX



REF	OEM
REC19233-ZV5-000	19233-ZV5-000
	BF35AM BF40B, B2, BX, A4, D, DK2, A, A1, 2, AX, AY BF45AM BF25D4, DK2, A, A1, AX, A2, A3 BF30D4, K2, A, A1, AX, AZ, A3 BF50A4, D, DK2, A, A1, A2, AX



REF	OEM
REC27-8172771	19232-ZW1-003
	BF75A BF90A



RETÉN CUERPO DE BOMBA **SEAL WATER PUMP** **TENUTE CORPO POMPA** **JOINTS SPI DE POMPE À EAU**

REF	OEM
REC91252-ZV1-003	91252-ZV1-003
	B4.5B, BX, BK2, B4, B6 BF5A1, H, AK, AM, AX, AK2, A2, A3, A4 BF8B1, D1, D2, B2, DK2, D3, D4 BF9.9DK2, D1, D2, D3 BF10B1, D1, D4, DK2, B2, D2 BF50F



REF	OEM
REC91252-935-004	91252-935-004
	BF9.9A BF15A BF100A, B, C, D, E, F BF75A, B, C, D, K2, K3, E, F BF15AH, AK, AM, B, A1, A2, AX, B2, BX, A3, AY BF9.9AH, AK, AM, B, AX, BX, AY BF6BX, D6 BF8AX, B, BX, C, CX, AH, AK, AM





KITS DE REPARACIÓN BOMBA DE AGUA **WATER PUMP SERVICE KITS**

REF	OEM
REC06192-ZV1-C00	06192-ZV1-C00 06192-ZV1-000
	BF4.5B, BK2, BK0 BF5A1, AM, AX, AK2, A2, A3, A4





KIT RICAMBI POMPA ACQUA **KIT POMPE À EAU**

REF	OEM
REC06193-ZV5-020	06193-ZV5-020 06193-ZV5-000 06193-ZV5-010
	BF40A4, D, DK2, DK4 BF50A4, D, DK2, DK4



new

REF	OEM
REC06192-881-C00	06192-881-C00
	BF6B, BX, D6 BF8AX, B, BX, AM





REF	OEM
REC06192-ZW9-A30	06192-ZW9-A30
	BFP8D, BF8B2, BF8D2 BFP9.9D (XL) BF15D BF20D BF10D BFP10D



new

REF	OEM
REC06192-ZV4-000	06192-ZV4-000 19210-ZV4-651

 BF8C, CX
 BF9.9A
 BF15A2, A3, B2





REF	OEM
REC06192-ZV1-305	06192-ZV1-305 06192-ZW1-305

 BF75AT
 BF90AT



REF	OEM
REC06192-ZV7-000	06192-ZV7-000 06192-ZW2-000

 BF25D4, DK2, A2, A3
 BF30D4, DK2, A2, A3
 BF20A2



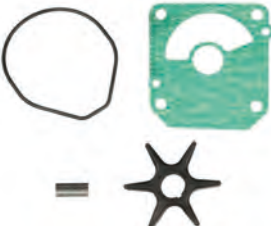

REF	OEM
REC06192-ZV1-000	06192-ZW1-000 06192-ZV1-000

 BF115A2, A3
 BF130A2, A3
 BF75DK0, DK1, A2, A3, DK2
 BF90 DK0, DK1, A2, A3, DK2



REF	OEM
REC06192-ZV5-003	06192-ZV5-003

 BF35AM
 BF40B, B2, BX, A4, D, DK2, AA1,A2, AX, A3
 BF45AM
 BF50A4, D, DK2, A, A21, A2, AX,A3



REF	OEM
REC06192-ZY6-000	06192-ZY6-000

 BF115D, DK1
 BF135A4, AK2
 BF150A4, AK2

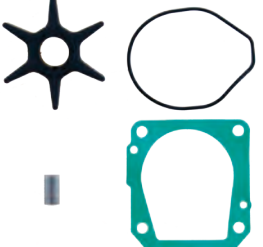

REF	OEM
REC47-43026Q06	19021-ZW1-003

 BF75AT
 BF90AT



REF	OEM
REC06192-ZY3-000	06192-ZY3-000 06192-ZX2-000

 BF175A3, A6, AK1, AK2, AK3
 BF200A2, A3, A6, AK1, AK2, AK3
 BF225A2, A3, A6, AK1, AK2, AK3
 BF250A

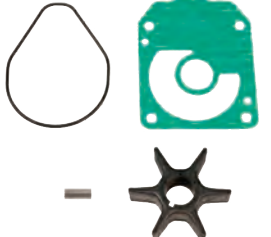



ÁNODO
ANODE
ANODI
ANODE

ZN	(KG)	AL	(KG)	OEM
CM06411-ZV5-000	0,36	CM06411-ZV5-000A	0,14	06411-ZV5-000 06411-ZV5-020

 BF35, 40, 45, 50
 150 x 35 mm





ZN	(KG)	AL	(KG)	OEM
CM826134	0,25	CM826134A	0,10	41109-ZW1-003 12155-ZV5-000

 BF20-->BF250 HP





ZN	(KG)	AL	(KG)	OEM
CM06411-ZW1-000	0,83	CM06411-ZW1-000A	0,33	06411-ZW1-000 06411-ZW1-020

 BF75 --> BF225 HP
 220 x 50 mm



ZN	(KG)	AL	(KG)	OEM
CM41109-ZW1-B00	0,22	CM41109-ZW1-B00A	0,11	41109-ZW1-B00

 BF40-->BF250 HP



ZN	(KG)	AL	(KG)	OEM
CM6E0-45251-11	0,10	CM6E0-45251-11A	0,04	2155-ZV5-000

BF2-->BF250 HP



ZN	(KG)	AL	(KG)	OEM
CM41107-ZW1-B01	0,44	CM41107-ZW1-B01A	0,20	41107ZW1-B01

BF75-->BF130 HP



ZN	(KG)	AL	(KG)	OEM
CM41106-ZW9-09000	0,99	CM41106-ZW9-000A		41106ZW909000 41106-ZW9-000

BF8-->BF50HP



ZN	(KG)	AL	(KG)	OEM
CM31640	0,45	CM31640A	0,21	06412-ZV1-000 411072ZW1003

BF75, 90, 115, 130



ZN	(KG)	AL	(KG)	OEM
CM41107-ZV500	0,29	CM41107-ZV500A	0,11	41107ZV500 06412-ZV5-000

BF20--> BF50HP



ZN	(KG)	AL	(KG)	OEM
CM664-45371-01	0,27	CM664-45371-01A	0,10	064-45371-01

BF20--> BF50HP



KITS DE ÁNODOS ANODES KIT KIT ANODI KIT ANODES

AL	MG
CMHBF4050KITA	CMHBF4050KITM

BF40 --> BF50



new

AL	MG
CMHBF35225KITA	CMHBF35225KITM

BF35 --> BF225



new

AL	MG
CMHBF75115KITA	CMHBF75115KITM

BF90 --> BF115



new

ÁNODO

ANODE

ANODI

ANODE

ZN	OEM	KG (KG)
TENO1404	06411-ZV5-000 06411-ZV5-020	0,380



BF35-->BF50 HP

ZN	OEM	KG (KG)
TENO1401	41106-935-812	0,080



Serie 8 /25HP

ZN	OEM	KG (KG)
TENO1406	06411-ZV1-000	0,860



BF75-->BF225 HP

ZN	OEM	KG (KG)
TENO1402	41106-ZV4-650	0,090



BF2-->BF15 HP

ZN	OEM	KG (KG)
TENO1405	06411-ZV1-000	0,250



Serie 75 - 130 HP

ZN	OEM	KG (KG)
TENO1400	41106-ZW-000	0,020

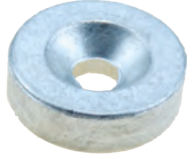

Serie 8 /25HP

ZN	OEM	KG (KG)
TENO1407	41109-ZW1-B00	0,230



BF40-->BF250 HP

ZN	OEM	KG (KG)
TENO1412	06412-ZV5-000	0,210



ZN	OEM	KG (KG)
TENO1408	12155-ZV4-A00	0,040



BF8->BF250 HP

ZN	OEM	KG (KG)
TENO1403	41107-ZV5-000	0,280



BF20-->BF50 HP

ZN	OEM	KG (KG)
TENO1408/1	12155-ZV5-000	0,030



BF20-->BF250 HP

ZN	OEM	KG (KG)
TENO1410	41107-ZW1-B01ZA	0,550



Serie 75 - 90 - 115 - 130 HP

ZN	OEM	KG (KG)
TENO1409	41106-ZW9-000	0,050



BF8-->BF50 HP

ZN	OEM	KG (KG)
TENO1411	41107-ZV1-003-ZA	0,480



BF75-->BF130 HP

KITS DE ÁNODOS

ANODES KIT

KIT ANODI

KIT ANODES

ZN	
TENKITHONDABF	TENO1410 x 1 TENO1406 x 1 TENO1407 x 2



BF75+

PARTES DEL MOTOR ENGINE PARTS

PARTI MOTORE PIECES MOTEUR

JUNTAS DE MOTOR ENGINE GASKET

GUARNIZIONI DE MOTORE

JOINTS DE MOTEUR





JUNTAS DE CULATA

CYLINDER HEAD GASKET

GUARNIZIONE DE TESTATA



JOINTS DE CULASSE

REF	OEM
REC12251-ZV7-004	12251-ZV7-004

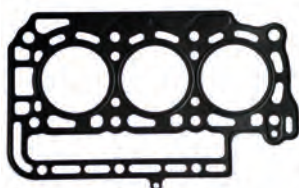
 BF20A, A2, AX
 BF25A, A1, 2, A3, AX
 BF30A, A1, A2, A3, AX
 VF25A2







REF	OEM
REC12251-ZW1-014	12251-ZW1-014 12251-ZW1-004

 BF40A4, D, K2, DK4
 BF50A4, BF50D, DK2, DK4



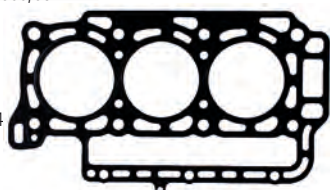

REF	OEM
REC12251-ZV5-003	12251-ZW4-H01 12251-ZV5-000/03

 BF35AM
 BF40B, BX, A, A1, AX, AY, A4, D,
 DK2, DK4
 BF45AM
 BF50A, A1, A4, AX, AY, D, DK2, DK4



REF	OEM
REC12251-ZW5-023	12251-ZW5-023 12251-ZW5-000/013

 BF115A1, A2, A3, AX
 BF130A1, A2, A3, AX

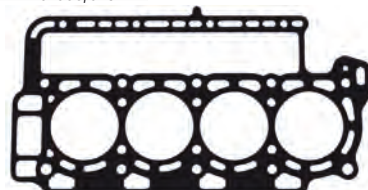



JUNTAS BASE DE MOTOR CYLINDER GASKET

GUARNIZIONE BASE MOTORE



JOINTS DE TÊTE MOTRICE

REF	OEM
REC23172-ZW1-013	23172-ZW1-013

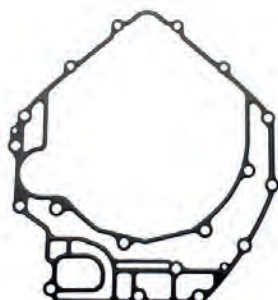
 BF75A1, A2, A3
 BF90A1, A2, A3



REF	OEM
REC23172-ZW5-013	23172-ZW5-013 23172-ZW5-000

 BF115A1, A2, A3, AX
 BF130A1, A2, A3, AX





JUNTAS BOMBA ACEITE GASKET, OIL PUMP

GUARNIZIONE POMPA OLIO

JOINTS DE POMPE A HUILE

REF	OEM
REC15112-ZW5-003	15112-ZW5-003

 BF115A1, A2, A3, AX
 BF130A1, A2, A3, AX

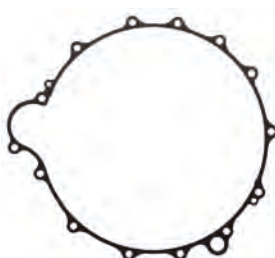



JUNTAS SILENCIOSO GASKET, MUFFLER

GUARNIZIONE SILENZIATORE

JOINTS DE SILENCIEU

REF	OEM
REC17384-ZW4-000	17384-ZW4-000

 BF25D4, DK2, A4
 BF30D4, DK2, A4



KIT DE JUNTAS

GASKET KIT

KIT GUARNIZIONE

KIT JOINTS

REF	OEM
RM061A1-ZV0-000	061A1-ZV0-000



BF20F

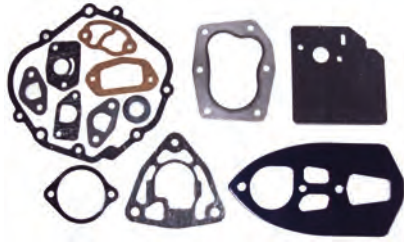

REF	OEM
RM06111-ZW1-020	06111-ZW1-000 06111-ZW1-020



BF75A1, AT, AV, AX
BF90, A1, AT, AV, AX



JUNTA TAPÓN DE DRENAJE

O-RING DRAIN CAP

GUARNIZIONE TAPPO DRENAGIO

JOINT DE VIDANGE

REF	OEM
REC12-191833	12-191833



CORREAS DE DISTRIBUCIÓN

TIMING BELT

CINGHIE DISTRIBUZIONE

COURROIES DE DISTRIBUTION

REF	OEM
RM14400-921-024	14400-921-024 14400-921-010



F8AX, B, BX, AH, AK, AM
BF6BX, D6
BF75A, B, C, D, K2, K3, E, F
BF100A, B, C, D, E, F



REF	OEM
RM14400-ZV4-004	14400-ZV4-004



BF8C, CX
BF9.9AH, AK, AM, B, AX, BX, AY
BF15AH, AK, AM, B, A1, A2, AX, B2, A3, AY



REF	OEM
REC14400-ZV5-014	14400-ZV5-004 14400-ZV5-014



BF35AM
BF40B, B2, BX, A, A1, A2, AX, AY
BF45AM
BF50A, A1, A2, AX, AY



REF	OEM
REC14400-ZZ3-004	14400-ZZ3-004



BF60A, AK1
BFP60AK1
BF40E



REF	OEM
RM14400-ZW1-004	14400-ZW1-004



BF75A1, AT, AV, AX, A2, A3
BF90A1, AT, AV, AX, A2, A3



SISTEMA DE ESCAPE Y ADMISIÓN EXHAUST & INTAKE SYSTEM

SISTEMA DI SCARICO E ASPIRAZIONE SYSTÈME D'ÉCHAPPEMENT ET D'ADMISSION

SISTEMA DE ESCAPE

EXHAUST SYSTEM

SISTEMA SCARICO

SYSTÈME D'ÉCHAPPEMENT

RETÉN VÁLVULA

VALVE SEALS

TENUTE

JOINT DE SOUPEPE

REF	OEM
REC12209-6B4-681	12209-GB4-681

- BF8B1, B2, D1, D2, DK2, D3, D4
- BF9.9DK2, D1, D2, D3
- BF10B1, D1, D4, DK2, D2



SISTEMA DE ADMISIÓN

INTAKE SYSTEM

SISTEMA ASPIRAZIONE

SYSTÈME D'ADMISSION

RETÉN VÁLVULA

VALVE SEALS

TENUTE

JOINT DE SOUPEPE

REF	OEM
REC12209-6B4-681	12209-GB4-681

- BF8B1, B2, D1, D2, DK2, D3, D4
- BF9.9DK2, D1, D2, D3
- BF10B1, D1, D4, DK2, D2



JUNTAS

GASKET,

GUARNIZIONE

JOINT

REF	OEM
REC16221-ZW9-000	16221-ZW9-000

- BF8B1, B2, D1, D2, DK2, D3, D4
- BF9.9DK2, D1, D2, D3
- BF10B1, D1, D4, DK2, B2, D2



REF	OEM
REC17109-ZY6-000	17109-ZY6-000

- BF115D, DK1
- BF135A4, AK2
- BF150A4, AK2
- BF75DK0, DK2, DK3
- BF90DK0, DK2, DK4
- BF100A
- BF80A



REF	OEM
REC16201-881-850	16201-881-850

- BF6B, BX, D6
- BF8AX, B, BX, AK, AM



REF	OEM
REC17105-ZY6-000	17105-ZY6-000

- BF115D, DK1
- BF135A4, AK2
- BF150A4, AK2



REF	OEM
REC16221-ZV4-610	16221-ZV4-610

- BF15AK, AM, B, A1, A2, AX, B2, BX, A3, A4
- BF9.9AK, AM, B, AX, BX, AY
- BF8C, CX



REF	OEM
REC17109-ZY3-004	17109-ZY3-004

- BF250A
- BF175A3, A6, AK1, AK2, AK3
- BF200A2, A3, A6, AK1, AK2, AK3
- BF225A2, A3, A6, AK1, AK2, AK3



REF	OEM
REC16221-ZW1-000	16221-ZW1-000

- BF75A1, AT, AV, AX, A2, A3
- BF90A1, AT, AV, AX, A2, A3



REF	OEM
REC17151-ZW5-000	17151-ZW5-000

- BF115A1, A2, A3, AX
- BF130A1, A2, A3, AX

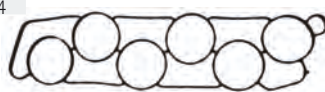

REF	OEM
REC17105-ZY3-004	17105-ZY3-004

- BF250A
- BF175A3, A6, AK1, AK2, AK3
- BF200A2, A3, A6, AK1, AK2, AK3
- BF225A2, A3, A6, AK1, AK2, AK3



UNIDADES DE TRANSMISIÓN UNIT DRIVES & COMPONENTS

UNITÀ DI TRASMISSIONE EMBASES ET PIECES

DESPIECE COLAS

GEAR CASE PARTS

PARTI PIEDI

PIECES D'EMBASSES

BF75AT • BF90AT

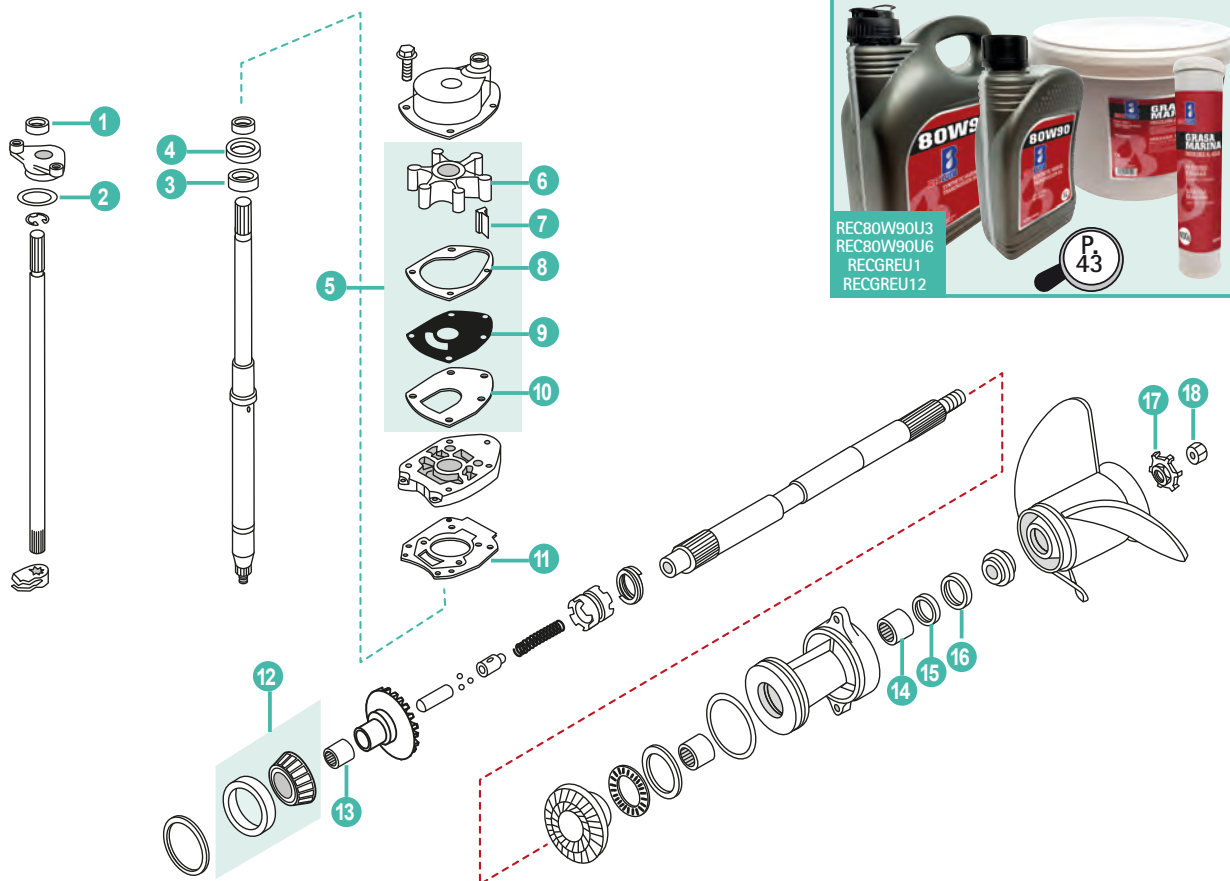

	REF	OEM				
1	REC26-8164641	91253-ZW1-003	RETÉN ACEITE	OIL SEAL	PARAOLIO	JOINT SPI
2	REC25-457101	91353-ZW1-003	TORICA	O-RING	O-RING	JOINT TORIQUE
3	REC26-43036	91254-ZW1-003	RETÉN ACEITE	OIL SEAL	PARAOLIO	JOINT SPI
4	REC26-43035	91251-ZW1-003	RETÉN ACEITE	OIL SEAL	PARAOLIO	JOINT SPI
5	REC47-43026Q06	19021-ZW1-003	KIT BOMBA AGUA	WATER PUMP KIT	KIT POMPA ACQUA	KIT POMPE À EAU
6	REC47-43026Q02	19120-ZW1-303	IMPULSOR	IMPELLER	GIRANTE	TURBINE
7	REC90752-ZW1-B02	90752-ZW1-003	CHAVETA IMPELLER	KEY	CHIUSURA	CLAVETTE TURBINE
8	REC27-8172771	19232-ZW1-003	JUNTA DE LA BOMBA	GASKET PUMPCASE	GUARNIZIONE POMPA	JOINT DE POMPE
9	REC8172761	19231-ZW1-003	BASE INOX	OUTER PLATE	PIASTRA INOX	BASE INOX
10	REC27-430331	19234-ZW1-003	JUNTA DE LA BOMBA	GASKET PUMPCASE	GUARNIZIONE POMPA	JOINT DE POMPE
11	REC27-430472	19242-ZW1-003	JUNTA	GASKET	GUARNIZIONE	JOINT
12	REC31-30894A1	91051-ZW1-003	RODAMIENTO AVAN.	BEARING FORWARD	CUSCINETTO AVANTI	ROULEMENT MARCHE AVANTE
13	REC31-30895T	91057-ZW1-003	RODAMIENTO	BEARING	CUSCINETTO	ROULEMENT
14	REC387247	91053-ZW1-003	RODAMIENTO AGUJAS	NEEDLE BEARING	CUSCINETTO ASSE	ROULEMENT A AIGUILLE
15	REC26-76868	91252-ZW1-003	RETEN	SEAL	TENUTA	JOINT SPI
16	REC26-70081	91351-ZW1-003	RETEN	SEAL	TENUTA	JOINT SPI
17	REC90508-ZW1-003	90508-ZW1-003	ARANDELA SEGURIDAD	WASHER TAB	RONDELLA	RONDELLE FREIN
18	REC90301-ZW1-003	90301-ZW1-003	TUERCA HELICE	NUT PROPELLER	DADO ELICHE	ÉCROU

HONDA

RECAMBIOS
MARINOS

COMPONENTES DE COLA

DRIVE COMPONENTS

COMPONENTI PIEDI

PIECES D' EMBASES

KITS JUNTAS Y RETENES

SEALS KITS

REF	OEM
REC18-8362-1	
Series 14ZV50M	
BF35/45 AM BF40/50 A, AW, AX	

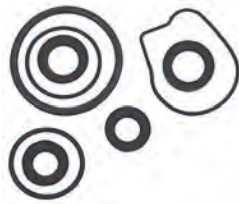

KIT GUARNIZIONE E TENUTE

KITS JOINTS D'EMBASE

REF	OEM
REC18-8363	
BF9.9 BF15	

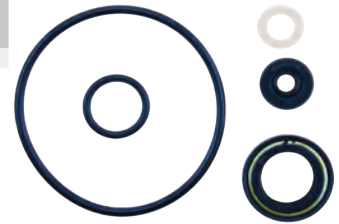

REF	OEM
REC18-8365	
BF115 BF130	

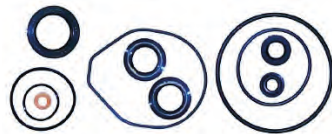

REF	OEM
REC18-8366	
BF75 BF90	

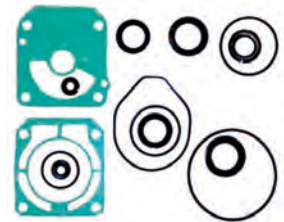

RETENES EJE DE TRASMISION

SEALS DRIVE SHAFT

TENUTE ASSE DI TRASMISSIONE

JOINTS SPI ARBRE DE TRANSMISSION

REF	OEM
REC26-43036	91254-ZW1-003
BF75AT BF90AT	



REF	OEM
REC26-43035	91251-ZW1-003
BF75AT BF90AT	



RETENES EJE DE HÉLICE

SEALS PROPELLER SHAFT

TENUTE ASSE ELICA

JOINTS SPI ARBRE D'HÉLICE

REF	OEM
REC26-76868	91252-ZW1-003
BF75AT BF90AT	



REF	OEM
REC26-70081	91255-ZW1-003 91351-ZW1-003
BF75AT BF90AT	



RETENES EJE DE CAMBIO

SEALS SHIFT SHAFT

TENUTE ASSE DI CAMBIO

JOINTS SPI ARBRE DE CHANGEMENT

REF	OEM
REC26-8164641	91253-ZW1-003
BF75AT BF90AT	



JUNTA EJE SELECTOR

O-RING DRIVE SHAFT

GUARNIZIONE ASSE TRASMISSIONE

JOINTS D'ARBRE DE SELECTEUR

REF	OEM
REC25-457101	91353-ZW1-003
DF75AT DF90AT	



TUERCA DIÁBOLO

NUT, GEARCASE END

DADO DIAVOLO

ECROU DE DIABOLO

REF	OEM
REC41109-ZV5-000	41109-ZV5-000

 BF35AM
 BF40B, B2, BX, A4, A/ A1, A2, AX, A3, AY
 BF45AM
 BF50A4, A/ A1, A2,AX, A3, AY



EJE HÉLICE

PROPELLER SHAFT

ASSE ELICA

ARBRE D'HELICE

REF	OEM
REC41161-ZV5-000	41161-ZV5-000

 BF35AM
 BF40B, B2, BX, A4, A/ A1, A2, AX, A3, AY
 BF45AM
 BF50A4, A/ A1, A2,AX, A3, AY



RODAMIENTO PIÑÓN AVANTE

FORWARD GEAR BEARING

CUSCINETTO PIGNONE AVANTI

ROULEMENT DE PIGNON AVANT

REF	OEM
REC31-30894A1	91051-ZW1-003

 BF75AT
 BT90AT



REF	OEM
REC31-30895T	91057-ZW1-003

 BF75AT
 BT90AT



RODAMIENTO DIÁBOLO

CARRIER BEARING

CUSCINETTO DIAVOLO

ROULEMENT DE DIABOLO

REF	OEM
REC387247	91053-ZW1-003

 BF75AT
 BF90AT



ARANDELA DE CIERRE

TAB WASHER

RONDELLA CHIUSURA

RONDELLE FREIN

REF	OEM
REC90508-ZW1-003	90508-ZW1-003

 BF75AT
 BF90AT



SISTEMA DE PROPULSIÓN PROPULSION SYSTEM

SISTEMA DI PROPULSIONE SYSTEME DE PROPULSION

HÉLICES ALUMINIO E INOXIDABLE DE 3 Y 4 PALAS 3 & 4 BLADE ALUMINIUM & SS PROPELLERS E LICHE ALLUMINIO E INOX DA 3 E 4 PALE HELICE ALUMINIUM ET INOX 3 ET 4 PALES

CÓDIGO DE REFERENCIAS PART NO. CODING SYSTEM SISTEMA DI CODICE CODAGE DES REFERENCES

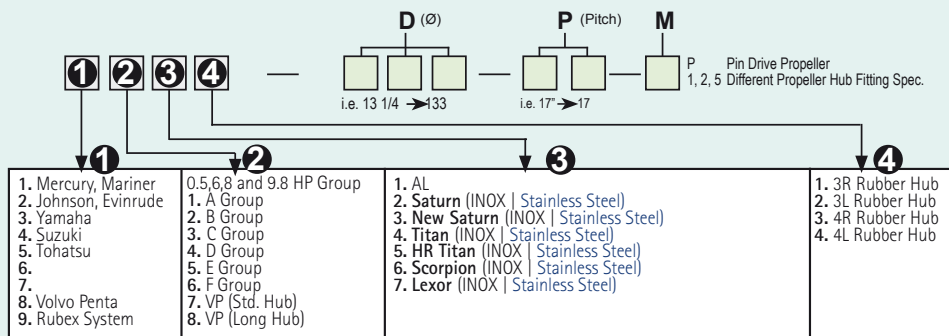

AMITA 3



Hélice de aluminio con núcleo de goma de gran resistencia.

Aluminum propeller with heavy duty rubber hub.

Eliche di alluminio con mozzi in gomma ad alta resistenza.

Hélice en aluminium avec moyeu en caoutchouc



AMITA 4



Hélices de aluminio con núcleo de goma de gran resistencia. Van muy suaves a poca velocidad y hace el barco muy manejable con la mar picada.

Aluminum propeller with heavy duty rubber hub. Smoother low speed makes the offshore boating activity much easier.

Eliche di alluminio con mozzo in gomma ad alta resistenza. Molto morbido a bassa velocità e rende la barca molto maneggevole con mare cattivo.

Hélice en aluminium avec moyeu en caoutchouc. Permet d'aller doucement à basse vitesse et rende le bateau très maniable lorsque la mer est agitée



TITAN



Hélices de acero inox. Diseño de pala grande para un área más grande. Gran capacidad de transporte de carga. Excelente economía de combustible.

Stainless steel propeller. High camber blade and large blade area design. Great load carrying capability. Excellent fuel economy.

Eliche in acciaio inossidabile. Ampia capacità di carico. Eccellente riduzione consumo del carburante.

Hélice en acier inoxydable. Lame à carrossage élevé et conception à grande surface de lame. Grande capacité de charge. Excellente économie de carburant.



NEW SATURN



Hélices de acero inoxidable. Ofrece buena aceleración y rendimiento. Tamaño más pequeño que ofrece un diámetro extragrande.

Stainless steel propeller. Offers good acceleration & all-round performance. Smaller pitch sizes offered in extra large diameter with increased blade area.

Eliche di acciaio inox. Buona accelerazione. Piccole dimensioni che offre un più grande diametro.

Hélice inox, offrant de bonnes accélérations et performances. Taille de pas réduite pour les modèles de grands diamètres avec une surface de pale plus importante.

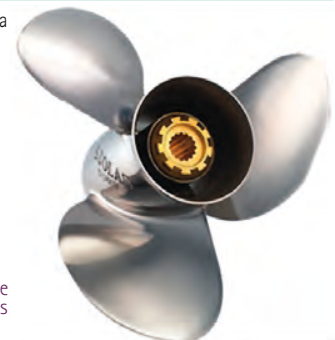

HR TITAN 3 PROP



Hélice de acero inoxidable. Alto rendimiento para cascos de alta velocidad. La inclinación de la hoja proporciona un excelente elevación de proa y aceleración. El diseño de copa grande aumenta la mordida y reduce el deslizamiento.

Stainless steel propeller. Performance prop for high speed planning hulls. High rake blade design provides excellent bow lift and acceleration. Heavy cup design increases bite and reduces slip.

Eliche in acciaio inox. Alte prestazioni per scafi ad alta velocità. Il passo della pala fornisce un'eccellente spinta e accelerazione. Il disegno aumenta le prestazioni.

Hélice en acier inoxydable. Hélice de performance pour les coques de planification à grande vitesse. La conception de la lame à haut râteau offre une excellente portance et accélération de l'arc. La conception lourde de la tasse augmente la morsure et réduit le glissement.



**GUÍA DE HÉLICES
CON NÚCLEO INTEGRADO**

**PROPELLERS APPLICATION
WITH RUBBER HUB**

**GUIDA ELICHE
CON MOZZO**

**GUIDE DES HELICES ET
MOYEURS**

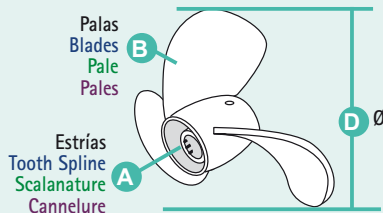

	R.O. OEM	A	B	D	P	R	AL		INOX STAINLESS STEEL			
							AMITA 3	AMITA 4	NEW SATURN	TITAN	HR TITAN 3	
BF2 Series	58130-ZV0-841ZB	3		7 ^{1/4}	6	R	Plastic	SOL6001-073-06P				
BF4		3		7 ^{7/8}	6 ^{3/4}	R		SOL6011-079-06P				
BF5					7 ^{1/2}			SOL6011-079-07P				
				9 ^{1/4}	7			SOL3111-093-07				
8 (2001+)	58130-ZV4-703ZB			9 ^{1/2}	8 ^{5/8}			SOL3111-093-08				
9.9 (1988+)	58130-ZV4-030ZB	8	3	9 ^{1/2}	9 ^{1/2}	R		SOL3111-093-09				
15 (1988+)				9 ^{1/4}	10			SOL3111-093-10				
20 (2003+)				9 ^{1/4}	11			SOL3111-093-11				
	58130-ZV7-850ZA			9 ^{3/4}	9 ^{7/8}			SOL5211-099-09				
								SOL5211-099-10				
25	58130-ZV7-000ZA	10	3	9 ^{1/4}	12	R		SOL5211-099-11				
30								SOL5211-099-12				
								SOL5211-099-13				
	58130-ZV5-860ZA			11 ^{3/4}	10			SOL3311-121-09				
								SOL3311-116-11				
35 (1991+)	58130-ZV5-850ZA			11 ^{1/2}	12			SOL3311-114-12				
40 (1995+)	58130-ZV5-000ZA			11 ^{1/4}	13			SOL3311-111-13				
45 (1991-94)	58130-ZV5-870ZA	13	3	11 ^{1/2}	14	R		SOL3311-111-14				
BF40EFI								SOL3311-110-15				
BF50EFI								SOL3311-110-16				
BF60EFI				11	16			SOL3311-110-17				
50 (1995+)				11	17			SOL3311-110-17				
	58130-ZW1-W01ZA			14	11	R		SOL6411-140-11			SOL6431-140-11	
	58130-ZW1-W11ZA			13.75-13.25	13	R		SOL6411-138-13	SOL6413-133-13		SOL6431-138-13	
				13.5	14	R		SOL6411-135-14				
				13.5-13	15	R		SOL6411-135-15	SOL6413-130-15		SOL6431-135-15	
	58130-ZW1-W31ZA			13.5	15	L		SOL6412-135-15				
				13.25-12.75	17	R		SOL6411-133-17	SOL6413-128-17		SOL6431-133-17	
75 (1995+)	58130-ZW1-W61ZA			13.25	17	L		SOL6412-133-17				
90 (1995+)	58130-ZW1-W41ZA	15	3	13-12.5	19	R		SOL6411-130-19	SOL6413-125-19		SOL6431-130-19	
115 (1998-09)				13-12.5	21	R		SOL6411-130-21	SOL6413-125-21		SOL6431-130-21	
130 (1998-09)												
BFP60A	08M60-ZW7-A40			14 ^{1/2}	15	R					SOL1531-145-15	
				14 ^{1/4}	17	R					SOL1531-143-17	
	08M60-ZW7-A00			14	19	R					SOL1531-140-19	
	08M60-ZW7-A10			14	21	R					SOL1531-140-21	
	08M60-ZW7-A20			14	23	R					SOL1531-140-23	
	08M60-ZW7-A30			14	25	R					SOL1531-140-25	
				15-14.75	15	R		SOL1511-150-15	SOL1513-148-15			
				15	15	L		SOL1512-150-15			SOL1532-145-15	
				14.8-14.5	17	R		SOL1511-148-17	SOL1513-145-17			
				14.8	17	L		SOL1512-148-17			SOL1532-143-17	
				14.5-14.25	19	R		SOL1511-145-19	SOL1513-143-19			
				14.5	19	L		SOL1512-145-19			SOL1532-140-19	
				14	21	R			SOL1513-140-21			
				14	23	R			SOL1513-140-23			
				14.3	21	R		SOL1511-143-21				
				14.3	21	L		SOL1512-143-21			SOL1532-140-21	
				14.2	23	R		SOL1511-142-23				
				14.2	23	L		SOL1512-142-23			SOL1532-140-23	
115 (2010+)				15 ^{1/2} -15 ^{3/4}	15	R					SOL1571-158-15	
130 (2010+)				15 ^{1/2} -15 ^{3/4}	15	L					SOL1572-158-15	
135 (2004+)				15 ^{1/4} -15 ^{1/2}	17	R				SOL1542-155-15	SOL1572-155-15	
150 (2004+)				15 ^{1/4} -15 ^{1/2}	17	R					SOL1571-155-17	
200 (2002+)				15 ^{1/4} -15 ^{1/2}	17	L					SOL1572-155-17	
225 (2002+)				15-15 ^{1/4}	19	R					SOL1571-153-19	
250 (2012+)				15-15 ^{1/4}	19	L				SOL1542-150-19	SOL1572-153-19	
				14 ^{3/4} -15	21	R					SOL1571-150-21	
				14 ^{3/4} -15	21	L					SOL1572-150-21	
				14 ^{1/2} -14 ^{3/4}	23	R					SOL1571-148-23	
				14 ^{1/2} -14 ^{3/4}	23	L					SOL1572-148-23	
				14 ^{1/2}	25	R					SOL1571-145-25	



- P** Paso
Pitch
Paso
Pas
R Rotación L (izquierda) R (derecha)
 Rotation L (left) R (Right)
 Rotazione L (SX) R (DX)
 Rotation L (gauche) R (droit)

NÚCLEO INTERCAMBIABLE INTERCHANGEABLE HUB

MOZZO INTERCAMBIABILE MOYEU INTERCHANGEABLE

	A	REF	
BF 35/45 (1991-94)	13	SOLRBX-113	C
BF 40/50/50A (1995+)	13	SOLRBX-102	D
75-90 HP (1995-98)	13	SOLRBX-107	D
75-90 HP (1999+)	13	SOLRBX-107	D
115-130HP (1998+)	15	SOLRBX-107	D
115-130HP (1998+)	15	SOLRBX-107	E
BF135, 150, 200, 225HP (2003+)	15	SOLRBX-107	E
BF250			



RUBEX

HÉLICES PARA NÚCLEO INTERCAMBIABLE

PROPELLERS FOR INTERCHANGEABLE HUB

ELICHE PER MOZZO INTERCAMBIABILE

HELICES AVEC MOYEU INTERCHANGEABLE

	B	D	P	R	AL
C 30-75 HP	3	12.1	9	R	SOL9311-121-09
		12	10	R	SOL9311-120-10
		11.6	11	R	SOL9311-116-11
		11.4	12	R	SOL9311-114-12
		11.1	13	R	SOL9311-111-13
		11.1	14	R	SOL9311-111-14
D 40-140 HP	3	11	15	R	SOL9311-110-15
		14	9	R	SOL9411-140-09
		14	11	R	SOL9411-140-11
		13.75	13	R	SOL9411-138-13
		13.50	15	R	SOL9411-135-15
		13.25	17	R	SOL9411-133-17
E 135-350 HP	3	13.2	19	R	SOL9411-132-19
		13.2	21	R	SOL9411-132-21
		15.5	11	R	SOL9511-155-11
		15.3	13	R	SOL9511-153-13
		16	13	R	SOL9511-160-13
		15	15	R	SOL9511-150-15
		15	15	L	SOL9512-150-15
		14.8	17	R	SOL9511-148-17
		14.8	17	L	SOL9512-148-17
		14.5	19	R	SOL9511-145-19
14.5	19	L	SOL9512-145-19		
14.3	21	R	SOL9511-143-21		
14.3	21	L	SOL9512-143-21		

	B	D	P	R	INOX STAINLESS STEEL
C 30-75 HP	3	11 5/8	11	R	SOL9331-116-11
		11 3/8	12	R	SOL9331-114-12
		11 1/8	13	R	SOL9331-111-13
		11 1/8	14	R	SOL9331-111-14
		11	15	R	SOL9331-110-15
		D 40-140 HP	3	13 3/4	13
13 3/4	13			L	SOL9432-138-13
13 1/2	15			R	SOL9431-135-15
13 1/2	15			L	SOL9432-135-15
13 1/4	17			R	SOL9431-133-17
13 1/4	17			L	SOL9432-133-17
E 90-140 HP	3	13	19	R	SOL9431-130-19
		13	19	L	SOL9432-130-19
		13	21	R	SOL9431-130-21
		14 1/2	15	R	SOL9531-145-15
		14 1/2	15	L	SOL9532-145-15
		14 1/4	17	R	SOL9531-143-17
		14 1/4	17	L	SOL9532-143-17
		14	19	R	SOL9531-140-19
		14	19	L	SOL9532-140-19
		14	21	R	SOL9531-140-21
E 135-350 HP	3	14	21	L	SOL9532-140-21
		14	23	R	SOL9531-140-23
		14	23	L	SOL9532-140-23
		15 3/4	15	R	SOL9571-158-15
		15 3/4	15	L	SOL9572-158-15
		15 1/2	17	R	SOL9571-155-17
		15 1/2	17	L	SOL9572-155-17
		15 1/4	19	R	SOL9571-153-19
		15 1/4	19	L	SOL9572-153-19
		15	21	R	SOL9571-150-21
15	21	L	SOL9572-150-21		
14 3/4	23	R	SOL9571-148-23		
14 3/4	23	L	SOL9572-148-23		
14 1/2	25	R	SOL9571-145-25		
14 1/2	25	L	SOL9572-145-25		

RUBEX



Núcleo intercambiable (no incluido).
Interchangeable hub (not included).
Mozzo intercambiabile (non incluso).
Moyeu interchangeable (non inclus)



REF--> RO / OEM

REF	R.O. / OEM	
C		
CEF500301	19210-ZW1-303	568
CEF500328	19210-ZV4-013	568
CEF500337	19210-ZW1-B04	568
CEF500338	19210-ZV5-003	568
CEF500339	19210-ZV7-003	568
CEF500343	19210-ZV4-651	568
CEF500347	19210-ZW9-013	568
CEF500348	19210-ZW9-A32	568
CEF500391	19210-ZY3-003	568
CM06411-ZV5-000	06411-ZV5-000	571
CM06411-ZV5-000	06411-ZV5-020	571
CM06411-ZV5-000A	06411-ZV5-000	571
CM06411-ZV5-000A	06411-ZV5-020	571
CM06411-ZW1-000	06411-ZW1-000	571
CM06411-ZW1-000	06411-ZW1-020	571
CM06411-ZW1-000A	06411-ZW1-000	571
CM06411-ZW1-000A	06411-ZW1-020	571
CM31640	06412-ZV1-000	572
CM31640	41107ZW1003	572
CM31640A	06412-ZV1-000	572
CM31640A	41107ZW1003	572
CM41106-ZW9-000A	41106-ZW9-000	572
CM41106-ZW9-000A	41106ZW909000	572
CM41106-ZW9-09000	41106-ZW9-000	572
CM41106-ZW9-09000	41106ZW909000	572
CM41106-ZW9-09000	41106-ZW9-090	545
CM41107-ZV500	06412-ZV5-000	572
CM41107-ZV500	41107ZV500	572
CM41107-ZV500A	06412-ZV5-000	572
CM41107-ZV500A	41107ZV500	572
CM41107-ZV500A	41107-ZV5-000	545
CM41107-ZW1-B01	41107ZW1-B01	572
CM41107-ZW1-B01A	41107ZW1-B01	572
CM41109-ZW1-B00	41109-ZW1-B00	571
CM41109-ZW1-B00A	41109-ZW1-B00	571
CM664-45371-01	06412-ZV5-000	572
CM664-45371-01A	06412-ZV5-000	572
CM6E0-45251-11	2155-ZV5-000	572
CM6E0-45251-11A	2155-ZV5-000	572
CM826134	12155-ZV5-000	571
CM826134	41109-ZW1-003	571
CM826134A	12155-ZV5-000	571
CM826134A	41109-ZW1-003	571
CMHBF35225KITA		546-572
CMHBF35225KITM		572
CMHBF4050KITA		545-546-572
CMHBF4050KITM		572
CMHBF75115KITA		546-572
CMHBF75115KITM		572
CHACJ14		559
CHAP10Y		559
CHAP8Y		559
CHAPROSU		559
CHARA6HC		559
CHARA8HC		559
CHARC9MC4		559
CHARN11YC4		559
G		
GS11290		561
GS11291		561
GS11292		561
GS11294		561
GS30435		552
GS31001		552
GS31002		552
GS31030	17660-ZV5-902	548
GS31031	17660-ZV5-A00	548
GS31031	17660-ZW9-003	548
GS31032	116977-ZV5-900	549
GS31033	116977-ZV5-A00	549
GS31034	17650-921-003ZB	548
GS31064		549
GS31065		552
GS31066		552
GS31067		552
GS31068		548
GS31069		548
GS31090		547
GS31095		547
GS31096		547
GS31097		547
GS31099		547
GS31155		552
GS31156		552
GS31157		552
GS31166		552
GS31183		547
GS31187		547
GS31189		547
GS35031		547
GS35032		547
L		
LENS3213	17670-ZW1-801AH	550-551
LENS3227		550
LENS3240	17670-ZW1-030GH	551
N		
NGKBMR4A		559
NGKBPR5ES	98079-55846	545-559
NGKCR5EH-9	98059-55916	545-559
NGKCR5HSB		559
NGKDR4HS		559

REF	R.O. / OEM	
NGKDR5HS	98066-55716	559
NGKDR6HS		545-559
NGKDR7EA	98069-5771P	545-546-559
NGKDR7EB	98069-5777P	546
NGKIZFR6K-11E	31916-ZY2-003	559
NGKIZFR6K11	31916-ZY3-003	546-559
NGKLMAR6C-9	31908-ZZ3-003	546-559
NGKZFR7F		546-559
P		
PAF15-04000003	90507-921-000	545-546
PAF15-07000031	19300-881-741	566
PAF15-07000031	19300-921-003	566
PAF15-07000031	19300-ZW9-003	566
PAF15-07000031	19300-ZW9-003	545-546-566-567
PAF4-04000030		548
PAF4-05000010		548
PAF40-0701000EI		550
PAGB/T91-2.5X30	90758-ZV1-000	545-546
PH130-0054	31200-ZV5-003	560
PH130-0054	31200-ZV5-013	560
PH130-0064	31200-ZW1-004	560
PH130-0065	31200-ZW5-003	560
PH130-0070	31200-ZY3-003	560
PH130-0070	31200-ZY3A-00304	560
PH200-T021	36120-ZV5-821	562
PH200-T046	36120-ZV5-822	562
PH200-WH01		562
PRE3300C05	24911-ZW7-U01	565
PRE3300C06	24912-ZW7-U01	565
PRE3300C07	24913-ZW7-U01	565
PRE3300C08	24914-ZW7-U01	565
PRE3300C09	24915-ZW7-U01	565
PRE3300C10	24916-ZW7-U01	565
PRE3300C11	24917-ZW7-U01	565
PRE3300C12	24918-ZW7-U01	565
PRE3300C13	24919-ZW7-U01	565
PRE3300C14	24920-ZW7-U01	565
PRE3300C15	24921-ZW7-U01	565
PRE3300C16	24922-ZW7-U01	565
PRE3300C17	24923-ZW7-U01	565
PRE3300C18	24924-ZW7-U01	565
PRE3300C19	24925-ZW7-U01	565
PRE3300C20	24926-ZW7-U01	565
PRE3300C21	24927-ZW7-U01	565
PRE3300C22	24928-ZW7-U01	565
PRE3300C23	24929-ZW7-U01	565
PRE3300C24	24930-ZW7-U01	565
PRE3300C25	24931-ZW7-U01	565
PRE3300C26	24932-ZW7-U01	565
PRE3300C27	24933-ZW7-U01	565
PRE3300C28	24934-ZW7-U01	565
PRE3300C29	24935-ZW7-U01	565
PRE3300C30	24936-ZW7-U01	565
PRE3300C31	24937-ZW7-U01	565
PRE3300C32	24938-ZW7-U01	565
R		
RAC025-RAC-02	06176-ZW3-801AH	553
RAC120R-RAC-01	06178-ZW1-030GH	551
RAC23289-10		550
RAC23299-10		550
RAC320R-INOX-01	06177-ZW1-801AH	551
RAC320R-INOX-02		551
RAC320R-RAC-01		550-551
RAC320R-RAC-02		551
RAC320R-RAC-03	06177-ZW1-801AH	550-551
RAC490R-RAC-01		550
RACPF5510		549
RACRK22628		552
RACS2502	17670-ZW3-801AH	553
RACS3213	17670-ZW1-801AH	550-551
RACS3220UL		551
RACS3227		550
RACS3240	17670-ZW1-030GH	551
REC004		559
REC06160-ZV4-U11	06160-ZV4-U11	556
REC06164-PCA-000	16450-ZY6-003	555
REC06192-881-C00	06192-881-C00	570
REC06192-ZV1-000	06192-ZW1-000	546-571
REC06192-ZV1-000	06192-ZV1-000	571
REC06192-ZV1-305	06192-ZV1-305	546-571
REC06192-ZV1-305	06192-ZW1-305	571
REC06192-ZV1-C00	06192-ZV1-C00	545-570
REC06192-ZV4-000	06192-ZV4-000	545-571
REC06192-ZV4-000	19210-ZV4-651	571
REC06192-ZV5-003	06192-ZV5-003	545-546-571
REC06192-ZV7-000	06192-ZV7-000	545-571
REC06192-ZW9-A30	06192-ZW9-A30	545-570
REC06192-ZY3-000	06192-ZX2-000	571
REC06192-ZY3-000	06192-ZY3-000	571
REC06192-ZY3-000	06192-ZY3-000	546
REC06192-ZY6-000	06192-ZY6-000	546-571
REC06193-ZV5-020	06193-ZV5-000	570
REC06193-ZV5-020	06193-ZV5-010	570
REC06193-ZV5-020	06193-ZV5-020	570
REC06211-ZV1-505	06211-ZV1-505	545
REC06211-ZV4-505	06211-ZV4-505	545
REC06211-ZV5-505	06211-ZV5-505	545
REC06211-ZV7-505	06211-ZV7-505	545
REC06211-ZW0-505	06211-ZW0-505	546
REC06211-ZW5-505	06211-ZW5-505	546
REC06211-ZW9-505	06211-ZW9-505	545

REF	R.O. / OEM	
REC06211-ZY0-505	06211-ZY0-505	545
REC06211-ZY2-506	06211-ZY2-506	546
REC06211-ZY5-505	06211-ZY5-505	546
REC06211-ZY9-505	06211-ZY9-505	546
REC06211-ZZ3-506	06211-ZZ3-506	546
REC06211-ZZ5-505	06211-ZZ5-505	546
REC06240-ZW5-U40	06240-ZW5-U40	564
REC06240-ZW5-U40	06240-ZW5-U001	564
REC06240-ZW5-U60	06240-ZW5-U60	564
REC09401-11425		548
REC09401-11425		548
REC09401-11425BULK		548
REC09401-11425BULK		548
REC10W30U3	08207-10W30MFC-W	553
REC10W30U6	08209-10W30MFC-W	553
REC10W40U3		553
REC10W40U6		553
REC12-191833	12-191833	545-546-575
REC12209-6B4-681	12209-GB4-681	576
REC12251-ZV5-003	12251-ZW4-H01	574
REC12251-ZV5-003	12251-ZV5-000	574
REC12251-ZV5-003	12251-ZV5-003	574
REC12251-ZV7-004	12251-ZV7-004	574
REC12251-ZW1-014	12251-ZW1-004	574
REC12251-ZW1-014	12251-ZW1-014	574
REC12251-ZW5-023	12251-ZW5-003	574
REC12251-ZW5-023	12251-ZW5-013	574
REC12251-ZW5-023	12251-ZW5-023	574
REC14400-ZV5-014	14400-ZV5-004	575
REC14400-ZZ3-004	14400-ZZ3-004	575
REC15112-ZW5-003	15112-ZW5-003	574
REC15400-PLM-A01PE	15400-PH1-F03	554
REC15400-PLM-A01PE	15400-PLM-A01PE	554
REC15400-PLM-A01PE	15400-POH-305	554
REC15400-PLM-A01PE	15400-POH-305PE	554
REC15400-PLM-A01PE	15400-RTA-004	554
REC15400-PLM-A01PE	15400-RTA-004	554
REC15400-PLM-A01PE	15400-ZJ1-004	546-554
REC15400-RBA-F01	15400-RBA-F01	546-554
REC16010-ST5-993	16900-ST5-993	553
REC16010-ZV4-005	06160-ZV4-U11	556
REC16010-ZV4-005	16010-ZV4-005	556
REC16010-ZV4-005	16010-ZV4-005	556
REC16010-ZV4-005	16010-ZV4-005	556
REC16010-ZW9-003	16010-ZW9-003	556
REC16011-881-741	16011-881-741	555
REC16011-ZV4-005	16011-ZV4-005	555
REC16201-881-850	16201-881-850	576
REC16221-ZV4-610	16221-ZV4-610	576
REC16221-ZW1-000	16221-ZW1-000	576
REC16221-ZW9-000	16221-ZW9-000	576
REC16735-ZW5-003	16735-ZW5-003	555
REC16735-ZW5-003	16735-ZY3-004	555
REC16900-SA5-004	16900-SA5-004	545-546-552
REC16900-SR3-004	16900-SR3-004	546-552
REC16901-ZY3-003	16901-ZY3-003	553
REC16901-ZY3-003	16911-ZY3-003	553
REC16910-GB2-005	16900-GB2-005	545-552
REC16910-ZV4-015	169	

REF	R.O. / OEM	
REC19300-ZV5-043	19300-ZV5-013	566
REC19300-ZV5-043	19300-ZV5-023	566
REC19300-ZV5-043	19300-ZV5-033	566
REC19300-ZV5-043	19300-ZV5-043	566
REC19300-ZV5-043	19300-ZV5-043	546-566-567
REC22-8M0001721		548
REC23172-ZW1-013	23172-ZW1-013	574
REC23172-ZW5-013	23172-ZW5-013	574
REC24800-ZZ5-A02	24800-ZZ5-A01	564
REC24800-ZZ5-A02	24800-ZZ5-A02	564
REC24800-ZZ5-A02	24800-ZZ5-A22	564
REC24942	06177-ZX2-000HE	549
REC24950		549
REC24952	06177-ZX2-000HE	549
REC25-457101	91353-ZW1-003	577
REC25-457101	91353-ZW1-003	578
REC25000		549
REC25010		549
REC25020		549
REC25030		549
REC25W40U3		553
REC26-43035	91251-ZW1-003	577-578
REC26-43036	91254-ZW1-003	577-578
REC26-70081	91255-ZW1-003	578
REC26-70081	91351-ZW1-003	577-578
REC26-76868	91252-ZW1-003	577-578
REC26-8164641	91253-ZW1-003	577-578
REC27-430331	19234-ZW1-003	569-577
REC27-430472	19242-ZW1-003	570-577
REC27-8172771	19232-ZW1-003	570-577
REC2TU3		553
REC2TU6		553
REC30520-PNA-007	30520-PNA-007	559
REC30520-PWC-003	30520-PWC-S01	559
REC30530-P8F-A01	30530-P8F-A01	558
REC30530-PNA-003	30530-PNA-003	558
REC30530-RNA-A01	30530-RNA-A01	558
REC30580-ZV4-013	30580-ZV4-023	559
REC31-30894A1	91051-ZW1-003	577-579
REC31-30895T	91057-ZW1-003	577-579
REC31200-ZW9-802	31200-ZW9-801	560
REC31200-ZW9-802	31200-ZW9-802	560
REC31200-ZY6-003	31200-ZY6-003	560
REC31200-ZY6-003	31200-ZY9-003	560
REC31200-ZY6-003	31200-ZY9A-0031	560
REC31630-ZW5-003	31630-ZW5-003	561
REC31630-ZY3-003	31630-ZY3-003	561
REC31630-ZY6-003	31630-ZY6-003	561
REC31630-ZY6-003	31630-ZY6-013	561
REC31638-ZY3-003	31638-ZY3-003	561-562
REC31638-ZY6-003	31638-ZY6-003	561-562
REC35-802893Q		549
REC35-802893Q01		549
REC35-822626Q03	15400-PFB-004	554
REC35-822626Q03	15400-PFB-014	554
REC35-822626Q03	15400-PFRB-007	554
REC35-822626Q03	15400-PJ7-015	554
REC35-822626Q03	15400-PM3-004	554
REC35-822626Q03	15400-PM3-405	554
REC35-822626Q03	15400-ZW4-003	554
REC35-822626Q03	15400-ZW4-003	545-546-554
REC35100-ZV5-013	35100-ZV5-013	565
REC35655-ZY3-013	35655-ZY3-013	558
REC35655-ZY9-003	35655-ZY9-003	558
REC35668-ZY6-003	35668-ZY6-003	558
REC36120-ZW4-H12	36120-ZW4-H12	562
REC36120-ZY6-013	36120-ZY6-013	563
REC36120-ZY6-013	36120-ZY6-023	563
REC36120-ZY9-003	36120-ZY9-003	563
REC36120-ZY9-003	36120-ZY9-013	563
REC37260-RNA-A01	37260-RNA-A01	558
REC37500-PNB-003	37500-PNB-003	557
REC37510-PNB-003	37510-PNB-003	557
REC37830-PGK-A01	37830-PGK-A01	557
REC37830-PNC-003	37830-PNC-003	557
REC37830-RNA-A01	37830-RNA-A01	557
REC37840-R70-A01	37840-R70-A01	557
REC37880-PLC-004	37880-PLC-004	558
REC387247	91053-ZW1-003	577-579
REC40135		552
REC40145		552
REC40155		552
REC40165		552
REC40970		561
REC40990		561
REC41109-ZV5-000	41109-ZV5-000	579
REC41161-ZV5-000	41161-ZV5-000	579
REC47-43026Q02	19120-ZW1-303	577
REC47-43026Q02	19210-ZW1-303	567
REC47-43026Q02	19210-ZW1-303	568
REC47-43026Q06	19021-ZW1-003	571-577
REC5GH-13440-00	15400-PFB-007	554
REC5W40U3	08207-5W30M2	553
REC5W40U6		553
REC650-24351-51		548
REC67F-12411-01	19300-ZX2-003	566-567
REC6AH-12411-00	19300-ZY3-023	566-567
REC6E5-12411-30	19300-ZY6-003	566-567
REC6E5-24351-51		548
REC70720		552
REC80W90U3	08739-90W	553
REC80W90U6		553

REF	R.O. / OEM	
REC8172761	19231-ZW1-003	569-577
REC855686		549
REC90301-ZW1-003	90301-ZW1-003	577
REC90508-ZW1-003	90508-ZW1-003	577-579
REC90752-ZV4-650	90752-ZV4-650	569
REC90752-ZV5-003	90752-ZV5-003	546-569
REC90752-ZV7-000	90752-ZV7-000	569
REC90752-ZW1-B02	90752-ZW1-003	577
REC90752-ZW1-B02	90752-ZW1-B02	569
REC90752-ZY3-003	90752-ZY3-003	569
REC90794-46866		551
REC90794-46868		551
REC91252-935-004	91252-935-004	570
REC91252-ZV1-003	91252-ZV1-003	570
RECOBRACKET		549
RECOBLEMENT		550
RECOFILALU		550
RECOFILTER		550
RECPIN4		563
RECPIN4.5		563
RECPIN6		563
RECTOOLTRIM1		563
RECTOOLTRIM2		563
RECTOOLTRIM3		563
RECTOOLTRIMKIT		563
RECYL-225-15		551
RM06111-ZW1-020	06111-ZW1-000	575
RM061A1-ZV0-000	061A1-ZV0-000	575
RM14400-921-024	14400-921-010	575
RM14400-921-024	14400-921-024	575
RM14400-ZV4-004	14400-ZV4-004	575
RM14400-ZW1-004	14400-ZW1-004	575
RM19211-ZV0-003	19211-ZV0-003	568
RM35-802893Q		549
RM92-858026QB1U6		553
RM92-858027QB1U3		553
RM92-8M0086220U6		553
RM92-8M0086221U3		553
S		
SIE18-8013		547
SIE18-8015		547
SOL1511-142-23	58233-ZY3-A23H	581
SOL1511-143-21	58233-ZY3-A21H	581
SOL1511-145-19	58233-ZY3-A19H	581
SOL1511-148-17	58233-ZY3-A17H	581
SOL1511-150-15	58233-ZY3-A15H	581
SOL1512-142-23		581
SOL1512-143-21		581
SOL1512-145-19		581
SOL1512-148-17		581
SOL1512-150-15		581
SOL1513-140-21	58233-ZY3-A21H	581
SOL1513-140-23	58233-ZY3-A23H	581
SOL1513-143-19	58233-ZY3-A19H	581
SOL1513-145-17	58233-ZY3-A17H	581
SOL1513-148-15	58233-ZY3-A15H	581
SOL1531-140-19	08M60-ZW7-A00	581
SOL1531-140-21	08M60-ZW7-A10	581
SOL1531-140-23	08M60-ZW7-A20	581
SOL1531-140-25	08M60-ZW7-A30	581
SOL1531-143-17	58233-ZY3-A17H	581
SOL1531-145-15	08M60-ZW7-A40	581
SOL1532-140-19	58233-ZY3-B19H	581
SOL1532-140-21		581
SOL1532-143-17	58233-ZY3-B17H	581
SOL1532-145-15	58233-ZY3-B15H	581
SOL1542-150-19		581
SOL1542-155-15		581
SOL1571-145-25		581
SOL1571-148-23		581
SOL1571-150-21		581
SOL1571-153-19		581
SOL1571-155-17		581
SOL1571-158-15		581
SOL1572-148-23		581
SOL1572-150-21		581
SOL1572-153-19		581
SOL1572-155-17		581
SOL1572-158-15		581
SOL1572-153-19		581
SOL3111-093-07		581
SOL3111-093-08		581
SOL3111-093-09	58130-ZV4-703ZB	581
SOL3111-093-10	58130-ZV4-030ZB	581
SOL3111-093-11		581
SOL3111-110-15		581
SOL3111-110-16		581
SOL3111-110-17		581
SOL3111-111-13	58130-ZV5-000ZA	581
SOL3111-111-14	58130-ZV5-870ZA	581
SOL3111-114-12	58130-ZV5-850ZA	581
SOL3111-116-11		581
SOL3111-121-09	58130-ZV5-860ZA	581
SOL5211-099-09	58130-ZV7-850ZA	581
SOL5211-099-10		581
SOL5211-099-11	58130-ZV7-000ZA	581
SOL5211-099-12		581
SOL5211-099-13		581
SOL6001-073-06P	58130-ZV0-841ZB	581
SOL6011-079-06P		581
SOL6011-079-07P		581
SOL6411-130-19	58130-ZW1-W41ZA	581
SOL6411-130-21	58130-ZW1-W41ZA	581

REF	R.O. / OEM	
SOL6411-133-17	58130-ZW1-W31ZA	581
SOL6411-135-14		581
SOL6411-135-15	58130-ZW1-W21ZA	581
SOL6411-138-13	58130-ZW1-W11ZA	581
SOL6411-140-11	58130-ZW1-W01ZA	581
SOL6412-133-17	58130-ZW1-W61ZA	581
SOL6412-135-15	58130-ZW1-W31ZA	581
SOL6413-125-19	58130-ZW1-W41ZA	581
SOL6413-125-21	58130-ZW1-W41ZA	581
SOL6413-128-17	58130-ZW1-W31ZA	581
SOL6413-130-15	58130-ZW1-W21ZA	581
SOL6413-133-13	58130-ZW1-W11ZA	581
SOL6413-133-17	58130-ZW1-W41ZA	581
SOL6413-130-21	58130-ZW1-W41ZA	581
SOL6413-133-17	58130-ZW1-W31ZA	581
SOL6431-135-15	58130-ZW1-W21ZA	581
SOL6431-138-13	58130-ZW1-W11ZA	581
SOL6431-140-11	58130-ZW1-W41ZA	581
SOL9311-110-15		582
SOL9311-111-13		582
SOL9311-111-14		582
SOL9311-114-12		582
SOL9311-116-11		582
SOL9311-120-10		582
SOL9311-121-09		582
SOL9331-110-15		582
SOL9331-111-13		582
SOL9331-111-14		582
SOL9331-114-12		582
SOL9331-116-11		582
SOL9331-114-12		582
SOL9331-116-11		582
SOL9331-116-11		582
SOL9411-132-19		582
SOL9411-132-21		582
SOL9411-133-17		582
SOL9411-135-15		582
SOL9411-138-13		582
SOL9411-140-09		582
SOL9411-140-11		582
SOL9431-130-19		582
SOL9431-130-21		582
SOL9431-133-17		582
SOL9431-135-15		582
SOL9431-138-13		582
SOL9432-130-19		582
SOL9432-133-17		582
SOL9432-135-15		582
SOL9432-138-13		582
SOL9511-143-21		582
SOL9511-145-19		582
SOL9511-148-17		582
SOL9511-150-15		582
SOL9511-153-13		582
SOL9511-155-11		582
SOL9511-160-13		582
SOL9531-140-19		582
SOL9531-140-21		582
SOL9531-140-23		582
SOL9531-143-17		582
SOL9531-145-15		582
SOL9532-140-19		582
SOL9532-140-21		582
SOL9532-140-23		582
SOL9532-143-17		582
SOL9532-145-15		582
SOL9571-145-25		582
SOL9571-148-23		582
SOL9571-150-21		582
SOL9571-153-19		582
SOL9571-155-17		582
SOL9571-158-15		582
SOL9572-145-25		582
SOL9572-148-23		582
SOL9572-150-21		582
SOL9572-153-19		582
SOL9572-155-17		582
SOL9572-158-15		582
SOLRBX-102		582
SOLRBX-107		582
SOLRBX-113		582
TEN01400	41106-ZW-000	573
TEN01401	41106-935-812	573
TEN01402	41106-ZV4-650	545-573
TEN01403	41107-ZV5-000	573
TEN01404	06411-ZV5-000	573
TEN01404	06411-ZV5-020	573
TEN01405	06411-ZV1-000	573
TEN01406	06411-ZV1-000	573
TEN01407	41109-ZW1-B00	573
TEN01408	12155-ZV4-A00	573
TEN01408/1	12155-ZV5-000	545-573
TEN01409	41106-ZW9-000	573
TEN01410	41107-ZW1-B01ZA	573
TEN01411	41107-ZV1-003-ZA	573
TEN01412	06412-ZV5-000	573

RO / OEM --> REF

R.O. / OEM	REF		R.O. / OEM	REF		R.O. / OEM	REF	
06111-ZW1-000	RM06111-ZW1-020	575	12251-ZW4-H01	REC12251-ZV5-003	574	19210-ZW9-013	CEF500347	568
06111-ZW1-020	RM06111-ZW1-020	575	12251-ZW5-003	REC12251-ZW5-023	574	19210-ZW9-013	REC19210-ZW9-013	545-567-568
06160-ZV4-U11	REC06160-ZV4-U11	556	12251-ZW5-013	REC12251-ZW5-023	574	19210-ZW9-A31	REC19210-ZW9-A32	568
06160-ZV4-U11	REC16010-ZV4-005	556	12251-ZW5-023	REC12251-ZW5-023	574	19210-ZW9-A32	CEF500348	568
06176-ZW3-801AH	RAC025-RAC-02	553	14400-921-010	RM14400-921-024	575	19210-ZW9-A32	REC19210-ZW9-A32	568
06177-ZW1-801AH	RAC320R-INOX-01	551	14400-921-024	RM14400-921-024	575	19210-ZY3-003	CEF500391	568
06177-ZW1-801AH	RAC320R-RAC-03	550-551	14400-ZV4-004	RM14400-ZV4-004	575	19210-ZY3-003	REC19210-ZY3-003	568
06177-ZX2-000HE	REC24942	549	14400-ZV5-004	REC14400-ZV5-014	575	19210-ZY9-H01	REC19233-ZV5-H01	567-568
06177-ZX2-000HE	REC24952	549	14400-ZW1-004	RM14400-ZW1-004	575	19211-ZV0-003	RM19211-ZV0-003	568
06178-ZW1-030GH	RAC120R-RAC-01	551	14400-ZZ3-004	REC14400-ZZ3-004	575	19231-ZW1-003	REC8172761	569-577
06192-881-C00	REC06192-881-C00	570	15112-ZW5-003	REC15112-ZW5-003	574	19232-881-850	REC19232-881-850	569
06192-ZV1-305	REC06192-ZV1-305	546-571	15400-PFB-004	REC35-822626Q03	554	19232-ZV1-A10	REC19232-ZV1-A10	569
06192-ZV1-000	REC06192-ZV1-C00	570	15400-PFB-007	REC5GH-13440-00	554	19232-ZV4-610	REC19232-ZV4-610	570
06192-ZV1-000	REC06192-ZV1-000	571	15400-PFB-014	REC35-822626Q03	554	19232-ZW1-003	REC27-8172771	570-577
06192-ZV1-C00	REC06192-ZV1-C00	545-570	15400-PFRB-007	REC35-822626Q03	554	19233-ZV5-000	REC19233-ZV5-000	570
06192-ZV4-000	REC06192-ZV4-000	545-571	15400-PH1-F03	REC15400-PLM-A01PE	554	19234-881-850	REC19234-881-850	569
06192-ZV5-003	REC06192-ZV5-003	545-546-571	15400-PJ7-015	REC35-822626Q03	554	19234-ZW1-003	REC27-430331	569-577
06192-ZV7-000	REC06192-ZV7-000	545-571	15400-PLM-A01PE	REC15400-PLM-A01PE	554	19234-ZY3-000	REC19234-ZY3-000	570
06192-ZW1-000	REC06192-ZV1-000	546-571	15400-PM3-004	REC35-822626Q03	554	19242-ZV5-000	REC19242-ZV5-000	569
06192-ZW1-305	REC06192-ZV1-305	571	15400-PM3-405	REC35-822626Q03	554	19242-ZW1-003	REC27-430472	570-577
06192-ZW2-000	REC06192-ZV7-000	571	15400-POH-305	REC15400-PLM-A01PE	554	19300-881-741	PAF15-0700031	566
06192-ZW9-A30	REC06192-ZW9-A30	545-570	15400-POH-305PE	REC15400-PLM-A01PE	554	19300-881-761	REC19300-881-761	545-566-567
06192-ZX2-000	REC06192-ZY3-000	571	15400-RBA-F01	REC15400-RBA-F01	546-554	19300-921-003	PAF15-0700031	566
06192-ZY3-000	REC06192-ZY3-000	546-571	15400-RTA-003	REC15400-PLM-A01PE	554	19300-ZV5-003	REC19300-ZV5-043	566
06192-ZY6-000	REC06192-ZY6-000	546-571	15400-RTA-004	REC15400-PLM-A01PE	554	19300-ZV5-013	REC19300-ZV5-043	566
06193-ZV5-000	REC06193-ZV5-020	570	15400-ZJI-004	REC15400-PLM-A01PE	546-554	19300-ZV5-023	REC19300-ZV5-043	566
06193-ZV5-010	REC06193-ZV5-020	570	15400-ZW4-003	REC35-822626Q03	545-546-554	19300-ZV5-033	REC19300-ZV5-043	566
06193-ZV5-020	REC06193-ZV5-020	570	16010-ZV4-005	REC16010-ZV4-005	556	19300-ZV5-043	REC19300-ZV5-043	546-566-567
061A1-ZV0-000	RM061A1-ZV0-000	575	16010-ZW9-003	REC16010-ZW9-003	556	19300-ZW9-003	PAF15-0700031	545-546-566-567
06211-ZV1-505	REC06211-ZV1-505	545	16011-881-741	REC16011-881-741	555			567
06211-ZV4-505	REC06211-ZV4-505	545	16011-ZV4-005	REC16011-ZV4-005	555	19300-ZX2-003	REC67F-12411-01	566-567
06211-ZV5-505	REC06211-ZV5-505	545	16201-881-850	REC16201-881-850	576	19300-ZY3-023	REC6AH-12411-00	566-567
06211-ZV7-505	REC06211-ZV7-505	545	16221-ZV4-610	REC16221-ZV4-610	576	19300-ZY6-003	REC6ES-12411-30	566-567
06211-ZW0-505	REC06211-ZW0-505	546	16221-ZW1-000	REC16221-ZW1-000	576	2155-ZV5-000	CM6E0-45251-11	572
06211-ZW5-505	REC06211-ZW5-505	546	16221-ZW9-000	REC16221-ZW9-000	576	2155-ZV5-000	CM6E0-45251-11A	572
06211-ZW9-505	REC06211-ZW9-505	545	16450-ZY6-003	REC06164-PCA-000	555	23172-ZW1-013	REC23172-ZW1-013	574
06211-ZY0-505	REC06211-ZY0-505	545	16735-ZW5-003	REC16735-ZW5-003	555	23172-ZW5-013	REC23172-ZW5-013	574
06211-ZY2-506	REC06211-ZY2-506	546	16735-ZY3-004	REC16735-ZY3-004	555	24800-ZZ5-A01	REC24800-ZZ5-A02	564
06211-ZY5-505	REC06211-ZY5-505	546	16900-GB2-005	REC16900-GB2-005	545-552	24800-ZZ5-A02	REC24800-ZZ5-A02	564
06211-ZY9-505	REC06211-ZY9-505	546	16900-SA5-004	REC16900-SA5-004	545-546-552	24800-ZZ5-A22	REC24800-ZZ5-A02	564
06211-ZZ3-506	REC06211-ZZ3-506	546	16900-SR3-004	REC16900-SR3-004	546-552	24911-ZW7-U01	PRE3300C05	565
06211-ZZ5-505	REC06211-ZZ5-505	546	16900-ST5-993	REC16900-ST5-993	553	24912-ZW7-U01	PRE3300C06	565
06240-ZW5-U40	REC06240-ZW5-U40	564	16901-ZY3-003	REC16901-ZY3-003	553	24913-ZW7-U01	PRE3300C07	565
06240-ZW5-U001	REC06240-ZW5-U40	564	16910-ZV4-015	REC16910-ZV4-015	545-552	24914-ZW7-U01	PRE3300C08	565
06240-ZW5-U60	REC06240-ZW5-U60	564	16911-ZY3-003	REC16901-ZY3-003	553	24915-ZW7-U01	PRE3300C09	565
06411-ZV1-000	TEN01405	573	16911-ZY3-010	REC16911-ZY3-010	546-553	24916-ZW7-U01	PRE3300C10	565
06411-ZV1-000	TEN01406	573	16911-ZZ5-003	REC16911-ZZ5-003	546-553	24917-ZW7-U01	PRE3300C11	565
06411-ZV5-000	CM06411-ZV5-000	571	17105-ZY3-004	REC17105-ZY3-004	576	24918-ZW7-U01	PRE3300C12	565
06411-ZV5-000	CM06411-ZV5-000A	571	17105-ZY6-000	REC17105-ZY6-000	576	24919-ZW7-U01	PRE3300C13	565
06411-ZV5-000	TEN01404	573	17109-ZY3-004	REC17109-ZY3-004	576	24920-ZW7-U01	PRE3300C14	565
06411-ZV5-020	CM06411-ZV5-000	571	17109-ZY6-000	REC17109-ZY6-000	576	24921-ZW7-U01	PRE3300C15	565
06411-ZV5-020	CM06411-ZV5-000A	571	17151-ZW5-000	REC17151-ZW5-000	576	24922-ZW7-U01	PRE3300C16	565
06411-ZV5-020	TEN01404	573	17384-ZW4-000	REC17384-ZW4-000	574	24923-ZW7-U01	PRE3300C17	565
06411-ZW1-000	CM06411-ZW1-000	571	17650-921-003ZB	GS31034	548	24924-ZW7-U01	PRE3300C18	565
06411-ZW1-000	CM06411-ZW1-000A	571	17660-ZV5-902	GS31030	548	24925-ZW7-U01	PRE3300C19	565
06411-ZW1-020	CM06411-ZW1-000	571	17660-ZV5-A00	GS31031	548	24926-ZW7-U01	PRE3300C20	565
06411-ZW1-020	CM06411-ZW1-000A	571	17660-ZW9-003	GS31031	548	24927-ZW7-U01	PRE3300C21	565
06412-ZV1-000	CM31640	572	17670-ZW1-030GH	LENS3240	551	24928-ZW7-U01	PRE3300C22	565
06412-ZV1-000	CM31640A	572	17670-ZW1-030GH	RAC53240	551	24929-ZW7-U01	PRE3300C23	565
06412-ZV5-000	CM41107-ZV500	572	17670-ZW1-801AH	LENS3213	550-551	24930-ZW7-U01	PRE3300C24	565
06412-ZV5-000	CM41107-ZV500A	572	17670-ZW1-801AH	RAC53213	550-551	24931-ZW7-U01	PRE3300C25	565
06412-ZV5-000	TEN01412	573	17670-ZW3-801AH	RAC52502	553	24932-ZW7-U01	PRE3300C26	565
06412-ZV5-000	CM664-45371-01	572	17710-ZW9-023	REC17710-ZW9-033	548	24933-ZW7-U01	PRE3300C27	565
06412-ZV5-000	CM664-45371-01A	572	17710-ZW9-033	REC17710-ZW9-033	548	24934-ZW7-U01	PRE3300C28	565
08207-10W30MFC-W	REC10W30U3	553	17822-90J00	REC09401-11425	548	24935-ZW7-U01	PRE3300C29	565
08207-5W30M2	REC5W40U3	553	17822-90J00	REC09401-11425BULK	548	24936-ZW7-U01	PRE3300C30	565
08209-10W30MFC-W	REC10W30U6	553	19021-ZW1-003	REC47-43026Q06	571-577	24937-ZW7-U01	PRE3300C31	565
08739-90W	REC80W90U3	553	19120-ZW1-303	REC47-43026Q02	577	24938-ZW7-U01	PRE3300C32	565
08M60-ZW7-A00	SOL1531-140-19	581	19210-881-003	REC19210-881-003	568	30520-PNA-007	REC30520-PNA-007	559
08M60-ZW7-A10	SOL1531-140-21	581	19210-881-A01	REC19210-881-003	568	30520-PWC-501	REC30520-PWC-003	559
08M60-ZW7-A20	SOL1531-140-23	581	19210-881-A02	REC19210-881-003	568	30530-P8F-A01	REC30530-P8F-A01	558
08M60-ZW7-A30	SOL1531-140-25	581	19210-ZV4-013	CEF500328	568	30530-PNA-003	REC30530-PNA-003	558
08M60-ZW7-A40	SOL1531-145-15	581	19210-ZV4-013	REC19210-ZV4-013	567-568	30530-RNA-A01	REC30530-RNA-A01	558
116977-ZV5-900	GS31032	549	19210-ZV4-651	CEF500343	568	30580-ZV4-023	REC30580-ZV4-013	559
116977-ZV5-A00	GS31033	549	19210-ZV4-651	REC06192-ZV4-000	571	31200-ZV5-003	PH130-0054	560
12-191833	REC12-191833	545-546-575	19210-ZV4-651	REC19210-ZV4-651	567-568	31200-ZV5-013	PH130-0054	560
12155-ZV4-A00	TEN01408	573	19210-ZV5-003	CEF500338	568	31200-ZW1-004	PH130-0064	560
12155-ZV5-000	CM826134	571	19210-ZV5-003	REC19210-ZV5-003	546-568	31200-ZW5-003	PH130-0065	560
12155-ZV5-000	CM826134A	571	19210-ZV7-003	CEF500339	568	31200-ZW9-801	REC31200-ZW9-802	560
12155-ZV5-000	TEN01408/1	545-573	19210-ZV7-003	REC19210-ZV7-003	567-568	31200-ZW9-802	REC31200-ZW9-802	560
12209-GB4-681	REC12209-GB4-681	576	19210-ZW1-303	CEF500301	568	31200-ZY3-003	PH130-0070	560
12251-ZV5-000	REC12251-ZV5-003	574	19210-ZW1-303	REC47-43026Q02	567-568	31200-ZY3A-0034	PH130-0070	560
12251-ZV5-003	REC12251-ZV5-003	574	19210-ZW1-B02	REC19210-ZW1-B02	568	31200-ZY6-003	REC31200-ZY6-003	560
12251-ZV7-004	REC12251-ZV7-004	574	19210-ZW1-B04	CEF500337	568	31200-ZY9-003	REC31200-ZY6-003	560
12251-ZW1-004	REC12251-ZW1-014	574	19210-ZW1-B04	REC19210-ZW1-B02	568	31200-ZY9A-0031	REC31200-ZY6-003	560
12251-ZW1-014	REC12251-ZW1-014	574	19210-ZW9-003	REC19210-ZW9-013	567	31630-ZW5-003	REC31630-ZW5-003	561

R.O. / OEM	REF		R.O. / OEM	REF	
31630-ZY3-003	REC31630-ZY3-003	561	58233-ZY3-A19H	SOL1513-143-19	581
31630-ZY6-003	REC31630-ZY6-003	561	58233-ZY3-A21H	SOL1511-143-21	581
31630-ZY6-013	REC31630-ZY6-003	561	58233-ZY3-A21H	SOL1513-140-21	581
31638-ZY3-003	REC31638-ZY3-003	561-562	58233-ZY3-A23H	SOL1511-142-23	581
31638-ZY6-003	REC31638-ZY6-003	561-562	58233-ZY3-A23H	SOL1513-140-23	581
31908-ZZ3-003	NGKLMAR6C-9	546-559	58233-ZY3-B15H	SOL1532-145-15	581
31916-ZX2-003	NGKIZFR6K-11E	559	58233-ZY3-B17H	SOL1532-143-17	581
31916-ZY3-003	NGKIZFR6K11	546-559	58233-ZY3-B19H	SOL1532-140-19	581
35100-ZV5-013	REC35100-ZV5-013	565	90301-ZW1-003	REC90301-ZW1-003	577
35655-ZY3-013	REC35655-ZY3-013	558	90507-921-000	PAF15-04000003	545-546
35655-ZY9-003	REC35655-ZY9-003	558	90508-ZW1-003	REC90508-ZW1-003	577-579
35668-ZY6-003	REC35668-ZY6-003	558	90752-ZV4-650	REC90752-ZV4-650	569
36120-ZV5-821	PH200-T021	562	90752-ZV5-003	REC90752-ZV5-003	546-569
36120-ZV5-822	PH200-T046	562	90752-ZV7-000	REC90752-ZV7-000	569
36120-ZW4-H12	REC36120-ZW4-H12	562	90752-ZW1-003	REC90752-ZW1-B02	577
36120-ZY6-013	REC36120-ZY6-013	563	90752-ZW1-B02	REC90752-ZW1-B02	569
36120-ZY6-023	REC36120-ZY6-013	563	90752-ZY3-003	REC90752-ZY3-003	569
36120-ZY9-003	REC36120-ZY9-003	563	90758-ZV1-000	PAGB/T91-2.5X30	545-546
37260-RNA-A01	REC37260-RNA-A01	558	91051-ZW1-003	REC31-30894A1	577-579
37500-PNB-003	REC37500-PNB-003	557	91053-ZW1-003	REC387247	577-579
37510-PNB-003	REC37510-PNB-003	557	91057-ZW1-003	REC31-30895T	577-579
37830-PGK-A01	REC37830-PGK-A01	557	91251-ZW1-003	REC26-43035	577-578
37830-PNC-003	REC37830-PNC-003	557	91252-935-004	REC91252-935-004	570
37830-RNA-A01	REC37830-RNA-A01	557	91252-ZV1-003	REC91252-ZV1-003	570
37840-R70-A01	REC37840-R70-A01	557	91252-ZW1-003	REC26-76868	577-578
37880-PLC-004	REC37880-PLC-004	558	91253-ZW1-003	REC26-8164641	577-578
41106-935-812	TEN01401	573	91254-ZW1-003	REC26-43036	577-578
41106-ZV4-650	TEN01402	545-573	91255-ZW1-003	REC26-70081	578
41106-ZW-000	TEN01400	573	91351-ZW1-003	REC26-70081	577-578
41106-ZW9-000	CM41106-ZW9-000A	572	91353-ZW1-003	REC25-457101	5779578
41106-ZW9-000	CM41106-ZW9-09000	572	98059-55916	NGKCR5EH-9	545-559
41106-ZW9-000	TEN01409	573	98066-55716	NGKDR5HS	559
41106-ZW9-090	CM41106-ZW9-09000	545	98069-5771P	NGKDR7EA	545-546-559
41106ZW909000	CM41106-ZW9-000A	572	98069-5777P	NGKDR7EB	546
41106ZW909000	CM41106-ZW9-09000	572	98079-55846	NGKBPR5ES	545-559
41107-ZV1-003-ZA	TEN01411	573			
41107-ZV5-000	CM41107-ZV500A	545			
41107-ZV5-000	TEN01403	573			
41107-ZW1-B01ZA	TEN01410	573			
411072ZW1003	CM31640	572			
411072ZW1003	CM31640A	572			
41107ZV500	CM41107-ZV500	572			
41107ZV500	CM41107-ZV500A	572			
41107ZW1-B01	CM41107-ZW1-B01	572			
41107ZW1-B01	CM41107-ZW1-B01A	572			
41109-ZV5-000	REC41109-ZV5-000	579			
41109-ZW1-003	CM826134	571			
41109-ZW1-003	CM826134A	571			
41109-ZW1-B00	CM41109-ZW1-B00	571			
41109-ZW1-B00	CM41109-ZW1-B00A	571			
41109-ZW1-B00	TEN01407	573			
41161-ZV5-000	REC41161-ZV5-000	579			
58130-ZV0-841ZB	SOL6001-073-06P	581			
58130-ZV4-030ZB	SOL3111-093-09	581			
58130-ZV4-703ZB	SOL3111-093-08	581			
58130-ZV5-000ZA	SOL3311-111-13	581			
58130-ZV5-850ZA	SOL3311-114-12	581			
58130-ZV5-860ZA	SOL3311-121-09	581			
58130-ZV5-870ZA	SOL3311-111-14	581			
58130-ZV7-000ZA	SOL5211-099-11	581			
58130-ZV7-850ZA	SOL5211-099-09	581			
58130-ZW1-W01ZA	SOL6411-140-11	581			
58130-ZW1-W01ZA	SOL6431-140-11	581			
58130-ZW1-W11ZA	SOL6411-138-13	581			
58130-ZW1-W11ZA	SOL6413-133-13	581			
58130-ZW1-W11ZA	SOL6431-138-13	581			
58130-ZW1-W21ZA	SOL6411-135-15	581			
58130-ZW1-W21ZA	SOL6413-130-15	581			
58130-ZW1-W21ZA	SOL6431-135-15	581			
58130-ZW1-W31ZA	SOL6411-133-17	581			
58130-ZW1-W31ZA	SOL6412-135-15	581			
58130-ZW1-W31ZA	SOL6431-133-17	581			
58130-ZW1-W41ZA	SOL6411-130-19	581			
58130-ZW1-W41ZA	SOL6411-130-21	581			
58130-ZW1-W41ZA	SOL6413-125-19	581			
58130-ZW1-W41ZA	SOL6413-125-21	581			
58130-ZW1-W41ZA	SOL6431-130-19	581			
58130-ZW1-W41ZA	SOL6431-130-21	581			
58130-ZW1-W61ZA	SOL6412-133-17	581			
58233-ZY3-A15H	SOL1511-150-15	581			
58233-ZY3-A15H	SOL1513-148-15	581			
58233-ZY3-A17H	SOL1511-148-17	581			
58233-ZY3-A17H	SOL1513-145-17	581			
58233-ZY3-A17H	SOL1531-143-17	581			
58233-ZY3-A19H	SOL1511-145-19	581			

BARCELONA

Jocelyn Bell, 26
Pol. Ca n'Alemanya
08840 Viladecans (Barcelona)
Tel. 902 10 85 85 - 93 633 34 80
Fax 93 662 66 59

International
phone: (+34) 93 662 66 55
Fax (+34) 93 662 66 59

info@recambiosmarinos.es
www.recambiosmarinos.es

GIRONA

C/ Gironés, 5
Pol. Ind. El Plà
17486 Castelló d'Empúries (Girona)
Tel. (+34) 972 158 809

girona@recmar.es

CANARIAS

Laura Grote de la Puerta, 3, Nave 5
Pol. Industrial El Mayorazgo
38110 Santa Cruz de Tenerife
Tel. (+34) 922 621 499

canarias@recmar.es

ITALIA

RECMAR SRL
Via Israele 10 H
Zona Industriale Settore 7
07026 Olbia (OT)

Tel. (+39) 0789 51962
Fax (+39) 0789 600177
sales@recmar.it