

**RECAMBIOS  
MARINOS**

# **YAMAHA SUZUKI HONDA TOHATSU SELVA**

**FUERABORDA • OUTBOARD • FUORIBORDO • HORS-BORD**

**2021  
2022**



[www.recambiosmarinos.es](http://www.recambiosmarinos.es)

# YAMAHA

ES

<b>GUÍA MANTENIMIENTO COLAS Y Y KITS</b>	<b>64</b>	<b>CDI Y CAJAS NEGRAS</b>	<b>117</b>	<b>INTERRUPTOR PANEL SIMPLE (704)</b>	<b>128</b>
<b>SISTEMA DE ALIMENTACIÓN Y FILTRACIÓN</b>	<b>74</b>	<b>DESCONECTORES DE SEGURIDAD</b>	<b>120</b>	<b>INTERRUPTOR POWER TRIM (703)</b>	<b>127</b>
<b>ACEITE</b>	<b>84</b>	<b>KITS</b>	<b>121</b>	<b>MANDO ACELERADOR</b>	<b>134</b>
<b>ACELERADOR</b>	<b>101</b>	<b>LLAVES DE ARRANQUE</b>	<b>113</b>	<b>MANETAS Y FIJACIONES</b>	<b>134</b>
VARILLA DE ACELERADOR	101	LLAVE DOBLE INSTALACIÓN	113	<b>MANDOS DE CONTROL</b>	<b>126</b>
<b>BOMBA DE COMBUSTIBLE EN LÍNEA</b>	<b>74</b>	LLAVE CON CHOQUE	114	CONECTORES DE CABLES	127
ABRAZADERA PARA MANGUERA	75	LLAVE PARA MANDO POPERO	114	MANDO LATERAL <small>PUSH TO TOPEN</small>	126
ADAPTADOR LÍNEA DE COMBUSTIBLE	75	MONTAJE EN MANDO DE CONTROL	113	MANDO LATERAL	127
BOMBA DE COMBUSTIBLE	74	MONTAJE EN PANEL	113	MANDO PARA CONSOLA	127
LÍNEA DE COMBUSTIBLE	74	<b>MOTORES DE ARRANQUE</b>	<b>110</b>	<b>SILENBLOCK</b>	<b>135</b>
MANGUERA DE COMBUSTIBLE	74	CABLE DE MOTOR DE ARRANQUE A BATERÍA	112	<b>SISTEMA DE REFRIGERACIÓN</b>	<b>136</b>
MUELLE TUBO COMBUSTIBLE	75	MUELLE DE ARRANQUE	112	<b>ÁNODOS</b>	<b>158</b>
<b>BOMBA DE COMBUSTIBLE</b>	<b>85</b>	PLATO Y PLACA DE ARRANQUE MANUAL	113	ÁNODO CANADA METAL	158
BOMBA DE COMBUSTIBLE ELÉCTRICA	86	TIRADOR DE ARRANQUE	113	ÁNODO TECNOSEAL	163
BOMBA DE COMBUSTIBLE MECÁNICA	85	TRINQUETE TRACCIÓN PLATO	112	GUÍA DE ÁNODOS	169
JUNTAS VST	88	<b>REGULADORES Y RECTIFICADORES</b>	<b>116</b>	KITS DE ÁNODOS CANADA METAL	162
MEMBRANAS Y JUNTAS	87	<b>SENSORES</b>	<b>102</b>	KITS DE ÁNODOS TECNOSEAL	168
REGULADORES DE PRESIÓN COMBUSTIBLE	89	SENSOR ACCELERACIÓN TS	103	TAPA DE ÁNODO (66M)	168
<b>BOMBA DE INYECCIÓN DE ACEITE</b>	<b>84</b>	SENSOR DE OXÍGENO	103	<b>BOMBA DE AGUA</b>	<b>147</b>
<b>CARBURADOR</b>	<b>91</b>	SENSOR MAP	102	CUERPO BOMBA DE AGUA	147
AGUJA CARBURADOR	98	SENSOR PRESIÓN DE ACEITE	103	GUÍA BOMBAS DE AGUA 4T	154
BOYAS	100	SENSOR TEMPERATURA DEL AGUA	103	GUÍA BOMBAS DE AGUA 2T	155
CARBURADOR COMPLETO	91	SENSOR TPS	102	GUÍA KITS DE BOMBA DE AGUA	153
CONECTOR DE CARBURADOR	100	<b>SOLENOIDE RELÉ</b>	<b>114</b>	KITS DE REPARACIÓN BOMBA DE AGUA	150
ELEMENTO FILTRO DEL CARBURADOR	101	<b>STARTOR</b>	<b>121</b>	TAPA DE LA BOMBA	148
GUÍA CARBURADORES	93	<b>TRIM, TILT &amp; POWER TRIM</b>	<b>122</b>	<b>GUÍA DE IMPULSORES</b>	<b>143</b>
JUNTAS CARBURADORES	94	EXTRACTOR TAPONES DE TRIM	125	KITS DE JUNTAS	144
KITS CARBURADORES	95	DESPIECE PISTÓN TRIM	125	<b>LÍQUIDO INHIBIDOR DE LA CORROSIÓN</b>	<b>136</b>
KIT 3 CARBURADORES	92	INSTALACIÓN ELÉCTRICA	122	<b>TERMOSTATO</b>	<b>136</b>
PASADOR DE BOYA	99	INTERRUPTOR POWER TRIM	122	CUBIERTAS TERMOSTATO	139
TORNILLOS CARBURADOR	98	POWER TRIM COMPLETO	124	GUÍA TERMOSTATO	137
VÁLVULA DE LÁMINAS	99	TRIM COMPLETO BIDIRECCIONAL	122	JUNTAS TAPA DE REFRIGERACIÓN	140
<b>COMPONENTES TANQUE Y CONECTORES</b>	<b>75</b>	<b>VOLANTE DE MOTOR</b>	<b>109</b>	JUNTAS TERMOSTATO	138
CONECTOR DE DEPÓSITO	76	ELÉCTRICO	109	NIPLE	139
FILTRO	76	SIN DIENTES (MANUAL)	109	RESORTE	139
LLAVE DE CIERRE DE DEPÓSITO	76	<b>SISTEMA DE GOBIERNO</b>	<b>126</b>	TERMOSTATO	136
MEDIDOR DE COMBUSTIBLE	76	<b>ARNÉS</b>	<b>128</b>	VÁLVULA ANTIPRESIÓN DE TERMOSTATO	139
PASAMAMPAROS	77	ARNÉS COMPLETO (703)	128	<b>PARTES DEL MOTOR</b>	<b>170</b>
RESORTE DE SEGURIDAD PARA TAPÓN	75	EXTENSIÓN DE ARNÉS (703/704)	128	<b>CIGÜEÑAL 4 TIEMPOS</b>	<b>219</b>
TAPÓN CON RESPIRADERO	75	<b>BRACKET</b>	<b>131</b>	GUÍA CIGÜEÑAL COMPLETO	219
TAPÓN	75	BRACKET BABOR	131	<b>CIGÜEÑAL 2 TIEMPOS</b>	<b>256</b>
<b>FILTRO DE ACEITE</b>	<b>83</b>	BRACKET ESTRIBOR	131	GUÍA BIELAS	260
GUÍA FILTROS DE ACEITE	83	CIRCLIP	132	GUÍA CIGÜEÑAL COMPLETO	256
<b>FILTRO DE COMBUSTIBLE Y ELEMENTOS</b>	<b>77</b>	CONECTOR	132	GUÍA PARTES DE CIGÜEÑAL	256
BRACKET	77	EJE CONECTOR ACELERADOR	132	GUÍA RODAMIENTOS DE MOTOR	257
FILTRO DECANTADOR DE COMBUSTIBLE COMPLETO CON VASO TRASPARENTE	78	ENGRASADOR INOX 316 M6	133	<b>DESPIECE MOTOR DE 4 TIEMPOS</b>	<b>170</b>
FILTRO COMBUSTIBLE MONTAJE EN LÍNEA	80	SOPORTE BARRA DE DIRECCIÓN	131	F2.5	170
FILTRO COMBUSTIBLE SEPARADOR AGUA	77	SOPORTE GIRATORIO	131	F4	174
GUÍA FILTROS DE COMBUSTIBLE	81	SOPORTE INFERIOR	132	F5 • F6	178
GUÍA FILTROS VST	82	RETÉN INFERIOR DEL BRACKET	132	F8	181
FILTRO VST	82	VARILLA DE BASCULACIÓN	132	F9.9	180
LLAVES PARA FILTRO	79	<b>BUJES</b>	<b>133</b>	F13.5 • F15	182
RACOR DE LATÓN	79	<b>COLLAR</b>	<b>133</b>	F20 • F25	190
<b>INYECTORES</b>	<b>89</b>	<b>COMPONENTES 703</b>	<b>129</b>	F30 • F40	196
GUÍA INYECTORES Y SENSORES	90	CABLE DE ACELERADOR	129	F50 • F60	202
INYECTOR	89	CABLES DE CONTROL	130	F70	204
<b>SISTEMA ELÉCTRICO</b>	<b>102</b>	ESPACIADOR	129	F80 • F100 • F115	208
<b>BOBINAS</b>	<b>104</b>	MANETA ACELERADOR	131	F150	210
BOBINA DE CARGA	106	PALANCA ACELERADOR	130	F200 • F225 • F250	212
BOBINA DE IGNICIÓN	104	PLACA CERRADURA SELECTOR	130	F300 • F350	214
BOBINA DE LUZ	104	RUEDA ACCELERACION	130	<b>DESPIECE MOTOR DE 2 TIEMPOS</b>	<b>220</b>
BOBINA DE PULSACIÓN	107	VARILLA DE ENLACE	130	2	220
BOBINA DE T.C.I.	106	<b>EJE DE CAMBIO</b>	<b>134</b>	4 • 5	221
BUJÍAS	108	<b>INTERRUPTORES PARA MANDOS</b>	<b>127</b>	6 • 8	222
		INTERRUPTOR PANEL COMPLETO O DOBLE ESTACIÓN	128	9.9 • 13.5 • 15	226
				25 • 30	228

YAMAHA

RECAMBIOS MARINOS



40	232
48 • 55	238
50 • 60 • 70	240
75 • 85	242
100 • 115 • 130 • 140	244
150 • 175 • 200 • 225	246
<b>GUÍA CORREAS DE DISTRIBUCIÓN</b>	<b>267</b>
<b>JUNTAS DE MOTOR 4 TIEMPOS</b>	<b>215</b>
JUNTAS BASE DE MOTOR	217
JUNTAS DE CULATA	215
KIT JUNTAS DE CULATA	216
GUÍA JUNTAS DE MOTOR	218
<b>JUNTAS DE MOTOR 2 TIEMPOS</b>	<b>248</b>
JUNTAS BASE DE MOTOR	252
JUNTAS DE CULATA	248
JUNTAS DE CULATÍN	255
GUÍA JUNTAS DE MOTOR	254
KITS JUNTAS DE CULATA	249
<b>PISTONES 4 TIEMPOS</b>	<b>219</b>
KITS DE PISTONES	219
<b>PISTONES 2 TIEMPOS</b>	<b>262</b>
GUÍA DE PISTONES Y SEGMENTOS	266
KIT DE PISTONES	262
<b>SISTEMA DE ESCAPE Y ADMISIÓN</b>	<b>268</b>
<b>SISTEMA DE ADMISIÓN</b>	<b>273</b>
JUNTAS DEL SISTEMA DE ADMISIÓN	273
<b>SISTEMA DE ESCAPE</b>	<b>268</b>
JUNTAS DE COLECTOR Y CARTER	270
JUNTAS DE SISTEMA DE ESCAPE	268
<b>UNIDADES DE TRANSMISIÓN</b>	<b>277</b>
<b>COLA COMPLETA</b>	<b>277</b>
COLAS DE 4 TIEMPOS	277
COLAS DE 2 TIEMPOS	279
<b>DESPIECE COLAS 4 TIEMPOS</b>	<b>282</b>
F2.5	282
F4	284
F5	286
F6 • F8 • F9.9	288
F13.5 • F15	290
F20 • F25	292
F30 • F40	298
F50 • F60	306
F70	314
F80 • F100	318
F115 • F130	322
F150 • F175 • F200	326
F225	330
F250 • F300	334
F350	340
<b>DESPIECE COLAS 2 TIEMPOS</b>	<b>342</b>
2	342
4 • 5	344
6 • 8	346
9.9	348
13.5 • 15	350
20 • 25 • 30	352
40 • 50	358
55	368
75 • 85	370
80 • 90	372
115 • 130	374
V6	378
225 • 250	382
VZ200 • VZ205 • VZ250 • VZ300	386
<b>GUÍA PIEZAS COLA</b>	<b>387</b>
<b>GUÍA RODAMIENTOS</b>	<b>393</b>
<b>SISTEMA DE PROPULSIÓN</b>	<b>401</b>
<b>HÉLICES ALUMINIO E INOXIDABLE DE 3 Y 4 PALAS</b>	<b>401</b>
GUÍA HÉLICES CON NÚCLEO INTEGRADO	402
GUÍA DE RECAMBIOS DE HÉLICE	405
HÉLICES PARA NÚCLEO INTERCAMBIABLE	404
NÚCLEO INTERCAMBIABLE	405
REF --> RO	406
RO --> REF	420

## EN

<b>DRIVES MAINTENANCE GUIDE &amp; KITS</b>	<b>64</b>	CONTROL BOX	113
<b>FUEL &amp; FILTRATION SYSTEM</b>	<b>74</b>	DASH MOUNT	113
<b>ACCELERATOR</b>	<b>101</b>	DUAL ENGINE APPLICATION	113
VARILLA DE ACELERADOR	101	KEY FOR STERN CONTROL	114
<b>CARBURATOR</b>	<b>91</b>	PUSH T. CHOKE	114
ACCELEROGRAPH CONTROL	100	<b>REGULATOR AND RECTIFIERS</b>	<b>116</b>
BOLT SCREW	98	<b>SENSORS</b>	<b>102</b>
CARBURETOR GASKES	94	MAP SENSOR	102
CARBURETOR KITS	95	OXYGEN SENSOR	103
ELEMENT FILTER (CARB INLET)	101	TPS SENDER	102
FLOATS	100	SENSOR	103
FULL CARBURATOR	91	SENSOR, OIL PRESSURE	103
GUIDE CARBURETORS	93	SENSOR, WATER TEMPERATURE	103
KIT 3 CARBURETORS	92	<b>SOLENOID RELAY</b>	<b>114</b>
NEEDLE VALVE	98	<b>STARTERS</b>	<b>110</b>
PIN FLOAT	99	CONNECTION LINE, POWER	112
VALVE OF SHEETS	99	PAWL, DRIVE	112
<b>FUEL FILTERS AND ELEMENTS</b>	<b>77</b>	PLATE & DRUM, DRIVE	113
BRACKET	77	STARTER HANDLE ASSY	113
COMPLET FUEL FILTER, TRANSPARENT BOWL	78	STEERING SPRING	112
FUEL FILTER GUIDE	82	<b>STARTOR</b>	<b>121</b>
FUEL FILTER GUIDE VST	81	<b>TRIM, TILT &amp; POWER TRIM</b>	<b>122</b>
FILTER KEY	79	COMPLETE POWER TRIM ASSEMBLY	124
IN-LINE FUEL FILTER	80	COMPLETE TRIM ASSEMBLY	122
RACOR MADE IN BRASS	79	PARTI PISTONE TRIM	125
VST FILTER	82	POWER TRIM SWITCH	122
WATER SEPARATING FUEL FILTER	77	TRIM PLUGS EXTRACTOR	125
<b>FUEL PUMP</b>	<b>85</b>	WIRING HARNESS	122
DIAPHRAGMS & GASKETS	87	<b>STEERING SYSTEM</b>	<b>126</b>
FUEL PUMP ELECTRIC	86	<b>ARNES</b>	<b>128</b>
FUEL PUMP MECHANICAL	85	ARNES ASSY (703)	128
FUEL REGULATOR	89	ARNES EXTENSION (703/704)	128
VST GASKETS	88	<b>BRACKET</b>	<b>131</b>
<b>FUEL PUMP IN LINE</b>	<b>74</b>	BOLT, CLAMP BRACKET	131
CLAMP SMALL	75	BRACKET OIL SEAL	132
COUPLER	75	BRACKET ROTARY	131
FUEL HOSE	74	CIRCLIP	132
FUEL LINE ASSEMBLY	74	CONNECTOR	132
FUEL PUMP	74	LEFT BRACKET ASSY	131
SPRING, FUEL PIPE	75	OILER M6	133
<b>FUEL TANK COMPONENTS &amp; CONNECTORS</b>	<b>75</b>	RIGHT BRACKET ASSY	131
FILTER	76	SHELL, MOUNT DAMPER	132
KNOB OIL SWITCH	76	THROTTLE SHAFT CONNECTOR	132
OLEOMETER ASSY	76	TILT ROD	132
PLUG	75	<b>BUSHINGS</b>	<b>133</b>
PLUG WITH BREATHER	75	<b>COMPONENTS 703</b>	<b>129</b>
TANK CONNECTOR	76	BLOCK CONTROL HANDLE	130
THRU HULL	77	CONTROL CABLES	130
SPRING, PREVENT DESQUAMATING	75	LEVER THROTTLE	130
<b>INJEKTOR</b>	<b>89</b>	LINK ROD ASSY	130
GUIDE INJECTORS & SENDERS	90	PLATE CONTROL BOX	129
INJEKTOR	89	THROTTLE CABLE	129
<b>OIL</b>	<b>84</b>	THROTTLE HANDLE INCHING	129
OIL FILTER	83	<b>ENGINE CONTROLS</b>	<b>126</b>
OIL FILTER GUIDE	83	CABLE CONNECTOR	127
OIL INJECTION PUMP	84	CONSOLE CONTROL	127
<b>ELECTRIC SYSTEM</b>	<b>102</b>	SIDE CONTROL PUSH TO OPEN	126
CDI & POWER PACK	117	SIDE CONTROL	127
<b>COILS</b>	<b>104</b>	HANDLE GEAR SHIFT ASSY	134
COIL LIGHTING	104	SILENBLOCK	135
CHARGE COIL	106	<b>STARTER HANDLE &amp; FIXINGS</b>	<b>134</b>
IGNITION COIL	104	<b>STEERING HANDLE ASSY</b>	<b>134</b>
PULSER COIL	107	<b>SWITCHES FOR ENGINE CONTROLS</b>	<b>127</b>
SPARK	108	PANEL TWIN STATION	128
T.C.I. COIL	106	POWER TRIM SWITCH (703)	127
<b>CUT OFF SWITCHES</b>	<b>120</b>	SWITCH (704)	128
KIT	121	<b>WASHER, BELOW</b>	<b>133</b>
<b>FLYWHELL</b>	<b>109</b>	<b>COOLING SYSTEM</b>	<b>136</b>
ELECTRIC	109	<b>ANODES</b>	<b>158</b>
WITHOUT TOOTH	109	ANODES APPLICATION	169
<b>IGNITION STARTER SWITCH</b>	<b>113</b>	ANODES CANADA METAL	158

**IT**

ANODES KIT CANADA METAL	162
ANODES KIT TECNOSEAL	168
ANODES TECNOSEAL	163
COVER ANODE (66M)	168
<b>GASKETS KIT</b>	<b>144</b>
IMPELLER GUIDE	143
SALT OFF	136
<b>THERMOSTAT</b>	<b>136</b>
GASKET, EXHAUST INNER COVER	140
NIPPLE	139
SPRING	139
THERMOSTAT	136
THERMOSTAT COVER	139
THERMOSTAT GASKETS	138
THERMOSTAT GUIDE	137
THERMOSTAT, PRESSURE VALVE	139
<b>WATER PUMP</b>	<b>147</b>
GUIDE WATER PUMP 4 STROKES	154
GUIDE WATER PUMP 2 STROKES	155
GUIDE WATER PUMP SERVICE KITS	153
HOUSING, WATER PUMP	147
WATER PUMP, COVER	148
WATER PUMP SERVICE KITS	150
<b>ENGINE PARTS</b>	<b>170</b>
<b>CRANKSHAFT 4 STROKES</b>	<b>219</b>
GUIDE CRANKSHAFT ASSY	219
<b>CRANKSHAFT 2 STROKES</b>	<b>256</b>
GUIDE CONNECTING ROD	260
GUIDE CRANKSHAFT ASSY	256
GUIDE CRANKSHAFT PARTS	256
GUIDE ENGINE BEARING	257
<b>ENGINE GASKET 4 STROKES</b>	<b>215</b>
ENGINE GASKET GUIDE	218
CYLINDER GASKET	217
CYLINDER HEAD GASKET	215
CYLINDER HEAD GASKET KIT	216
<b>ENGINE GASKET 2 STROKES</b>	<b>248</b>
ENGINE GASKET GUIDE	254
CYLINDER GASKET	252
CYLINDER HEAD GASKET	248
CYLINDER HEAD GASKET KIT	249
GASKET, HEAD COVER	255
<b>ENGINE PARTS 4 STROKES</b>	<b>170</b>
F2.5	170
F4	174
F5 • F6	178
F8	181
F9.9	180
F13.5 • F15	182
F20 • F25	190
F30 • F40	196
F50 • F60	202
F70	204
F80 • F100 • F115	208
F150	210
F200 • F225 • F250	212
F300 • F350	214
<b>ENGINE PARTS 2 STROKES</b>	<b>220</b>
2	220
4 • 5	221
6 • 8	222
9.9 • 13.5 • 15	226
25 • 30	228
40	232
48 • 55	238
50 • 60 • 70	240
75 • 85	242
100 • 115 • 130 • 140	244
150 • 175 • 200 • 225	246
<b>GUIDE TIMING BELT</b>	<b>267</b>
<b>PISTONS 4 STROKES</b>	<b>219</b>
PISTON KITS	219
<b>PISTON 2 STROKES</b>	<b>262</b>

GUIDE PISTON & RING	266
PISTON KITS	262
<b>EXHAUST &amp; INTAKE SYSTEM</b>	<b>268</b>
<b>EXHAUST SYSTEM</b>	<b>268</b>
EXHAUST GASKETS	268
GASKET, UPPERCASING, OIL PAN, MANIFOLD	270
<b>INTAKE SYSTEM</b>	<b>273</b>
GASKETS INTAKE	273
<b>UNIT DRIVES &amp; COMPONENTS</b>	<b>277</b>
<b>COMPLETE GEARCASE ASSY</b>	<b>277</b>
4 STROKES GEARCASE	277
2 STROKES GEARCASE	279
<b>GEAR CASE PARTS 4 STROKES</b>	<b>282</b>
F2.5	282
F4	284
F5	286
F6 • F8 • F9.9	288
F13.5 • F15	290
F20 • F25	292
F30 • F40	298
F50 • F60	306
F70	314
F80 • F100	318
F115 • F130	322
F150 • F175 • F200	326
F225	330
F250 • F300	334
F350	340
<b>GEARCASE PARTS 2 STROKES</b>	<b>342</b>
2	342
4 • 5	344
6 • 8	346
9.9	348
13.5 • 15	350
20 • 25 • 30	352
40 • 50	358
55	368
75 • 85	370
80 • 90	372
115 • 130	374
V6	378
225 • 250	382
VZ200 • VZ205 • VZ250 • VZ300	386
<b>STERN DRIVE BEARING APPLICATION</b>	<b>393</b>
<b>STERN DRIVE COMPONENTS GUIDE</b>	<b>387</b>
<b>PROPULSION SYSTEM</b>	<b>401</b>
<b>3 &amp; 4 BLADE ALUMINIUM &amp; SS PROPELLERS</b>	<b>401</b>
INTERCHANGEABLE HUB	405
PROPELLERS APPLICATION WITH RUBBER HUB	402
PROPELLERS FOR INTERCHANGEABLE HUB	404
PROPELLER SPARE PARTS	405
<b>REF --&gt; OEM</b>	<b>406</b>
<b>OEM --&gt; REF</b>	<b>420</b>

<b>GUIDA MANUTENZIONE E KIT</b>	<b>64</b>
<b>SISTEMA DI ALIMENTAZIONE E FILTRAZIONE</b>	<b>74</b>
<b>ACCELERATORE</b>	<b>101</b>
ASTA ACCELERATORE	101
<b>CARBURATORE</b>	<b>91</b>
CARBURATORE COMPLETO	91
CONTROLLO DELL'ACCELEROGRAFO	100
FILTRO CARBURATORE	101
GALLEGGIANTE	100
GUARNIZIONI CARBURATORI	94
GUIDA CARBURATORI	93
KIT CARBURATORI	95
KIT 3 CARBURATORI	92
SPILLO CONICO CARBURATORE	98
SPINOTTO GALLEGGIANTE	99
VALVOLA	99
VITE CARBURATORE	98
<b>COMPONENTI SERBATOIO E CONETTORI</b>	<b>75</b>
ATTACCO SERBATOIO	76
CHIAVE DE DEPOSITO BLOCCO	76
FILTRO	76
MISURATORE DI CARBURANTE	76
MOLLA SICURITÀ PER TAPPO	75
PASSASCAFO	77
SPINA CON RESPIRO	75
TAPPO	75
<b>FILTRI BENZINA E RACCORDI</b>	<b>77</b>
CHIAVE DA FILTRO	79
FILTRO BENZINA PER MONTARE IN LINEA	80
FILTRO DI DECANTAZIONE BENZINA COMPLETO CON VASCHETTA TRASPARENTE	78
FILTRO SEPARATORE ACQUA-BENZINA	77
FILTRO VST	82
GUIDA FILTRO BENZINA	81
GUIDA FILTRO BENZINA VST	82
RACCORDO IN OTTONE	79
SUPPORTO	77
<b>FILTRO OLIO</b>	<b>83</b>
GUIDA FILTRO OLIO	83
<b>INIETTORE</b>	<b>89</b>
GUIDA INIETTORI E SENSORI	90
INIETTORE	89
<b>OLIO</b>	<b>84</b>
<b>POMPA BENZINA IN LINEA</b>	<b>74</b>
ADATTATORE	75
FASCETTE	75
MOLLA TUBO COMBUSTIBILE	75
POMPA BENZINA	74
TUBO BENZINA	74
TUBO CARBURANTE	74
<b>POMPA BENZINA</b>	<b>85</b>
GUARNIZIONE VST	88
MEMBRANA E GUARNIZIONI	87
POMPA BENZINA ELETTRICA	86
POMPA BENZINA MECCANICA	85
REGOLATORE BENZINA	89
<b>POMPA INIEZIONE BENZINA</b>	<b>84</b>
<b>SISTEMA ELETTRICO</b>	<b>102</b>
<b>BOBINE</b>	<b>104</b>
BOBINE ACCENSIONE	107
BOBINA AVVIAMENTO	104
BOBINA DI CARICA	106
BOBINA LUCE	104
BOBINE T.C.I.	106
CANDELE	108
<b>CDI E CENTRALINA</b>	<b>117</b>
<b>CHIAVETTA DI SICUREZZA</b>	<b>120</b>
KIT	121
<b>CHIAVI DI ACCENSIONE</b>	<b>113</b>
CHIAVE CON CONTATTO	114
CHIAVE DOPPIA INSTALLAZIONE	113
CHIAVE PER COMANDO A GUIDA	114
MONTAGGIO NEL PANNELLO	113
MONTAGGIO NEL TELECOMANDO	113
<b>MOTORINI AVVIAMENTO</b>	<b>110</b>
CAVO MOTORE DI AVVIAMENTO A BATTERIA	112
CRICCHETTO TRAZIONE PLATTO	112
MANIGLIA AVVIAMENTO	113
MOLLA AVVIAMENTO	112
PLACCA E PLATTO DI AVVIAMENTO MANUALE	113
<b>REGOLATORI E RADDRIZZATORI</b>	<b>116</b>



<b>FILTRE À ESSENCE ET CARTOUCHE DE RECHANGE</b>	77	ETRIER DROIT	131	F150	210
CLÉ À FILTRE	79	ETRIER GAUCHE	131	F200 • F225 • F250	212
FILTRE À ESSENCE	77	CONNECTEUR	132	F300 • F350	214
FILTRE À ESSENCE EN LIGNE	80	GRAISSEUR M6 INOX 316	133	<b>PIECES MOTEUR 2 TEMPS</b>	220
FILTRE SÉPARATEUR D'ESSENCE	78	JOINT INFÉRIEUR DU SUPPORT	132	2	220
FILTRE VST	82	SUPPORT SILENT BLOCK	132	4 • 5	221
GUIDE FILTRE À ESSENCE	81	SUPPORT TOURNANT	131	6 • 8	222
GUIDE FILTRES VST	82	TUBE SUPPORT CABLE DE DIRECTION	131	9.9 • 13.5 • 15	226
RACCORD EN LAITON	79	TIGE DE CONNEXION ACCELERATEUR	132	25 • 30	228
TÊTE DE FILTRE À ESSENCE	77	<b>CALLE</b>	133	40	232
<b>FILTRE À HUILE</b>	83	COMMANDE D'INVERSION	134	48 • 55	238
GUIDE FILTRE A HUILE	83	<b>COMPOSANT (703)</b>	129	50 • 60 • 70	240
<b>HUILES</b>	84	BARRE D'ACCOUPLLEMENT COMPLETE	130	75 • 85	242
<b>INJECTEURS</b>	89	CÂBLE D'ACCELERATEUR	129	100 • 115 • 130 • 140	244
GUIDE INJECTEURS ET SONDÉS	90	CÂBLES DE COMMANDE	130	150 • 175 • 200 • 225	246
INJECTEUR	89	CALE POIGNEE DE CONTRÔLE	130	<b>PISTONS DE 2 TEMPS</b>	262
<b>POIRE À CARBURANT</b>	74	LEVIER DE COMMANDE	131	KIT DE PISTONS	262
COLLIER	75	PLAQUE BOITIER DE COMMANDE	129	GUIDE PISTONS ET SEGMENTS	266
POIRE À CARBURANT	74	POIGNEE DE PAPILLON	129	<b>PISTONS DE 4 TEMPS</b>	219
RACCORD COUPLEUR	75	ROUE D'ACCELERATEUR	130	KIT PISTON	219
RESSORT, TUYAU DE CARBURANT	75	<b>FAISCEAU ELECTRIQUE</b>	128	<b>VILEBREQUIN DE 4 TEMPS</b>	219
TUYAU CARBURANT	74	FAISCEAU ELECTRIQUE BOITIER CDE (703)	128	GUIDE VILEBREQUIN COMPLET	219
<b>POMPE À ESSENCE</b>	85	RALLONGE FAISCEAU (703/704)	128	<b>VILEBREQUIN DE 2 TEMPS</b>	256
POMPE À ESSENCE ELECTRIQUE	86	<b>INTERRUPTEUR DE CONTRÔLE</b>	127	GUIDE DE BIELLES	260
POMPE À ESSENCE MECANIQUE	85	BOITIER DE DEMARRAGE 2 MOTEURS	128	GUIDE PARTS DE VILEBREQUIN	256
JOINTS VST	88	COMMUTATEUR DE TRIM (703)	127	GUIDE ROULEMENTS DE MOTEUR	257
MEMBRANES ET JOINTS	87	TABLEAU DE COMMANDE SIMPLE (704)	128	GUIDE VILEBREQUIN COMPLET	256
REGULATEUR DE PRESSION D'ESSENCE	89	<b>POIGNEE DE DIRECTION</b>	134	<b>SYSTÈME D'ÉCHAPPEMENT ET SYSTÈME D'ADMISSION</b>	268
<b>POMPE D'INJECTION D'HUILE</b>	84	<b>POIGNEE LANCEUR ET DE SERRAGE</b>	134	<b>SYSTÈME D'ADMISSION</b>	273
		<b>SILENT BLOC</b>	135	JOINTS D'ADMISSION	273
<b>SYSTÈME ÉLECTRIQUE</b>	102	<b>SYSTÈME DE REFROIDISSEMENT</b>	136	<b>SYSTÈME D'ÉCHAPPEMENT</b>	268
<b>BOBINES</b>	104	<b>ANODES</b>	158	JOINTS D'ÉCHAPPEMENT	268
BOBINE D'ALLUMAGE	104	ANODE CANADA METAL	158	JOINTS DE COLLECTEUR ET CARTER D'HUILE	270
BOBINE D'ÉCLAIRAGE	104	ANODE TECNOSEAL	163	<b>EMBASES ET PIECES</b>	277
BOBINE DE CHARGE	106	COUVERCLE DU ANODE (66M)	168	<b>EMBASE COMPLETE</b>	277
BOBINE PULSEUR	107	GUIDE DES ANODES	169	EMBASES DE MOTEUR 4T	277
BOBINE T.C.I.	106	KIT ANODES CANADA METAL	162	EMBASES DE MOTEUR 2T	279
BOUGIES	108	KIT ANODES TECNOSEAL	168	<b>PIECES D'EMBASES DE 4 TEMPS</b>	282
<b>CDI ET BOITIER ELECTRONIQUE</b>	117	<b>GUIDE TURBINES</b>	143	F2.5	282
<b>CONTACTEUR A CLÉ</b>	113	<b>KITS JOINTS</b>	144	F4	284
AVEC STARTER	114	<b>POMPE D'EAU</b>	147	F5	286
CONTACTEUR A CLÉ COMPLET	114	CORPS DE POMPE À EAU	147	F6 • F8 • F9.9	288
MONTAGE POUR BOITIER DE COMMANDE	113	GUIDE KITS POMPES À EAU	153	F13.5 • F15	290
MONTAGE POUR TABLEAU DE BORD	113	GUIDE POMPE À EAU 4T	154	F20 • F25	292
POUR INSTALLATION DOUBLE	113	GUIDE POMPE À EAU 2T	155	F30 • F40	298
<b>CAPTEURS</b>	102	GUIDE POMPE À EAU 2T	155	F50 • F60	306
CAPTEUR D'ACCELERATEUR TS	103	KIT REPARATION DE POMPE À EAU	150	F70	314
CAPTEUR DE TEMPERATURE	103	PLAQUE DE POMPE À EAU	148	F80 • F100	318
CAPTEUR MAP	102	<b>THERMOSTAT</b>	136	F115 • F130	322
CAPTEUR TPS	102	COUVERCLE DE THERMOSTAT	139	F150 • F175 • F200	326
SONDE À OXYGENE	103	GUIDE DES THERMOSTATS	137	F225	330
SONDE DE PRESSION D'HUILE	103	JOINT DE PLAQUE DE REFROIDISSEMENT	140	F250 • F300	334
<b>COUPE CIRCUIT DE SECURITE</b>	120	JOINTS DE THERMOSTAT	138	F350	340
KITS	121	RESSORT	139	<b>PIECES D'EMBASES DE 2 TEMPS</b>	342
<b>DEMARREUR</b>	110	SOUPAPE DE PRESSION DE THERMOSTAT	139	2	342
CABLE DE CONNEXION	112	TETINE	139	4 • 5	344
ENTRAÎNEMENT	112	THERMOSTAT	136	6 • 8	346
POIGNEE DE LANCEUR	113	<b>SALT OFF</b>	136	9.9	348
RESSORT DE LANCEUR	112	<b>PIECES MOTEUR</b>	170	13.5 • 15	350
TAMBOUR, POULIE	113	<b>GUIDE DES COURROIES DE DISTRIBUTION</b>	267	20 • 25 • 30	352
<b>REGULATEURS ET RECTIFIEURS</b>	116	<b>JOINTS DE MOTEUR 4 TEMPS</b>	215	40 • 50	358
<b>SOLENOIDE RELAIS</b>	114	GUIDE JOINTS DE MOTEURS	218	55	368
<b>STARTOR</b>	121	JOINTS DE CULASSE	215	75 • 85	370
<b>TRIM, TILT &amp; POWER TRIM</b>	122	JOINTS DE TÊTE MOTRICE	217	80 • 90	372
INTERRUPTEUR DE TRIM	122	KIT JOINTS DE CULASSE	216	115 • 130	374
INSTALLATION ELECTRIQUE	122	<b>JOINTS DE MOTEUR 2 TEMPS</b>	248	V6	378
KIT EXTRACTEUR	125	GUIDE JOINTS DE MOTEURS	254	225 • 250	382
MOTEUR DE TRIM	122	JOINT DE CULASSE	248	VZ200 • VZ205 • VZ250 • VZ300	386
PIECES VERIN DE TRIM	125	JOINTS DE COUVRE CULASSE	255	<b>GUIDE PIECES D'EMBASE</b>	387
POWER TRIM COMPLET	124	JOINTS DE TÊTE MOTRICE	252	<b>GUIDE ROULEMENTS D'EMBASE</b>	393
<b>VOLANT MOTEUR</b>	109	KITS JOINT DE CULASSE	249	<b>SYSTÈME DE PROPULSION</b>	401
ÉLECTRIQUE	109	<b>PIECES MOTEURS DE 4 TEMPS</b>	170	<b>HELICE ALUMINIUM ET INOX 3 ET 4 PALES</b>	401
MANUEL SANS DENT	109	F2.5	170	GUIDE DES HELICES ET MOYEUX	402
<b>SYSTÈME DE DIRECTION</b>	126	F4	174	GUIDE DES PIECES POUR HELICE	405
<b>BAGUES</b>	133	F5 • F6	178	HELICES AVEC MOYEU INTERCHANGEABLE	404
<b>BOITIER DE COMMANDE</b>	126	F8	181	MOYEU INTERCHANGEABLE	405
BOITIER LATERAL <small>PUSH TO OPEN</small>	126	F9.9	180	<b>REF --&gt; RO</b>	406
BOITIER LATERAL	127	F13.5 • F15	182	<b>RO --&gt; REF</b>	420
BOITIER POUR CONSOLE	127	F20 • F25	190		
EMBOUT DE CABLE	127	F30 • F40	196		
<b>BRACKET</b>	131	F50 • F60	202		
BARRE DE TILT	132	F70	204		
CIRCLIP	132	F80 • F100 • F115	208		









GUÍA KITS  
MANTENIMIENTO

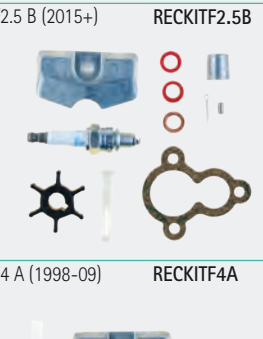
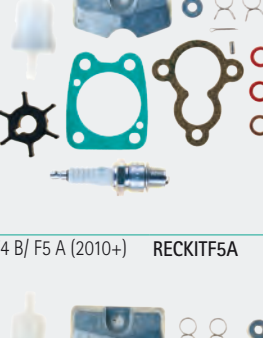
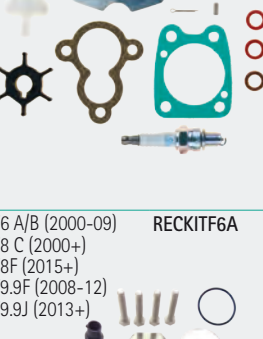
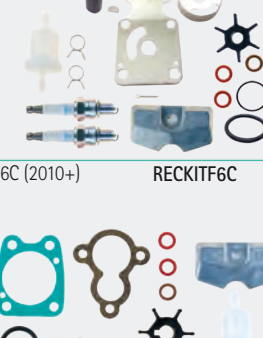

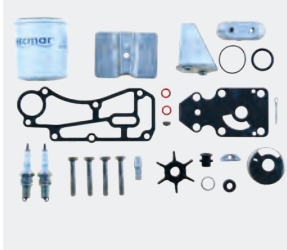

MAINTENANCE  
GUIDE & KITS

GUIDA  
MANUTENZIONE  
E KIT





GUIDE  
MAINTENANCE  
KITS

	KIT	REF							
	RECKITF2.5A	NGKBR6HS	BUJÍA	SPARK PLUG	CANDELE	BOUGIE	1		
		PAF4-04070003	ÁNODO	ANODE	ANODO	ANODE	1		
		PAF4-04000011	JUNTA	GASKET	GUARNIZIONE	JOINT	1		
		PAF4-04000006	JUNTA	GASKET	GUARNIZIONE	JOINT	1		
		PAF4-04120005	FILTRO COMBUSTIBLE	FUEL FILTER	FILTRO COMBUSTIBILE	FILTRE ESSENCE	1		
		REC90430-08020	JUNTA DESAGÜE	DRAIN GASKET	GUARNIZIONE DRENAGGIO	JOINT DE VIDANGE	x 2		
		PAF4-03000022	ÁNODO	ANODE	ANODO	ANODE	1		
		PAGB/T91-1.6X12	PIN BLOQUEADOR	COTTER PIN	COPPIGLIA	GOUPILLE	1		
		PAF2.6-03000013	PIN	PIN	PIN	PIN	1		
		PAF2.6-03000100	TURBINA	IMPELLER	GIRANTE	TURBINE	1		
		PAJASOF404-19-033	TÓRICA	O-RING	O-RING	JOINT TORIQUE	1		
			RECKITF2.5B	NGKCR6HSB	BUJÍA	SPARK PLUG	CANDELE	BOUGIE	1
				PAF4-04070003	ANODO	ANODE	ANODO	ANODE	1
				PAF4-04000011	JUNTA	GASKET	GUARNIZIONE	JOINT	1
PAF4-04000006	JUNTA			GASKET	GUARNIZIONE	JOINT	1		
PAF4-04120005	FILTRO COMBUSTIBLE			FUEL FILTER	FILTRO COMBUSTIBILE	FILTRE ESSENCE	1		
REC90430-08020	JUNTA DESAGÜE			DRAIN GASKET	GUARNIZIONE DRENAGGIO	JOINT DE VIDANGE	x 2		
PAF4-03000022	ÁNODO			ANODE	ANODO	ANODE	1		
PAGB/T91-1.6X12	PIN BLOQUEADOR			COTTER PIN	COPPIGLIA	GOUPILLE	1		
PAF2.6-03000013	PIN			PIN	PIN	PIN	1		
PAF2.6-03000100	TURBINA			IMPELLER	GIRANTE	TURBINE	1		
	RECKITF4A			NGKBR6HS	BUJÍA	SPARK PLUG	CANDELE	BOUGIE	1
				PAF4-04070003	ANODO	ANODE	ANODO	ANODE	1
				PAF4-04000011	JUNTA	GASKET	GUARNIZIONE	JOINT	1
				PAF4-03000018	JUNTA	GASKET	GUARNIZIONE	JOINT	1
		PAF4-05000300	FILTRO COMBUSTIBLE	FUEL FILTER	FILTRO COMBUSTIBILE	FILTRE ESSENCE	1		
		REC90430-08020	JUNTA DESAGÜE	DRAIN GASKET	GUARNIZIONE DRENAGGIO	JOINT DE VIDANGE	x 2		
		PAF4-03000022	ÁNODO	ANODE	ANODO	ANODE	1		
		PAGB/T91-1.6X12	PIN BLOQUEADOR	COTTER PIN	SPINOTTO	PIN	1		
		PAF4-03000016	PIN	PIN	PIN	PIN	1		
		PAF4-03060000	TURBINA	IMPELLER	GIRANTE	TURBINE	1		
		PAF4-04000030	MUELLE DEL TUBO DE COMBUSTIBLE	CLAMP	MOLLA TUBO COMBUSTIBILE	COLLIER TUYAU DE CARBURANT	x 2		
		PAF4-04000006	JUNTA	GASKET	GUARNIZIONE	JOINT	1		
			RECKITF5A	NGKCR6HSB	BUJÍA	SPARK PLUG	CANDELE	BOUGIE	1
				PAF4-04070003	ANODO	ANODE	ANODO	ANODE	1
PAF4-04000011	JUNTA			GASKET	GUARNIZIONE	JOINT	1		
PAF4-03000018	JUNTA			GASKET	GUARNIZIONE	JOINT	1		
REC68T-24251-00	FILTRO COMBUSTIBLE			FUEL FILTER	FILTRO COMBUSTIBILE	FILTRE ESSENCE	1		
REC90430-08020	JUNTA DESAGÜE			DRAIN GASKET	GUARNIZIONE DRENAGGIO	JOINT DE VIDANGE	x 2		
PAF4-03000022	ÁNODO			ANODE	ANODO	ANODE	1		
PAGB/T91-1.6X12	PIN BLOQUEADOR			COTTER PIN	COPPIGLIA	GOUPILLE	1		
PAF4-03000016	PIN			PIN	PIN	PIN	1		
PAF4-03060000	TURBINA			IMPELLER	GIRANTE	TURBINE	1		
PAF4-04000030	MUELLE DEL TUBO DE COMBUSTIBLE			SPRING, FUEL PIPE	MOLLA TUBO COMBUSTIBILE	COLLIER TUYAU DE CARBURANT	x 2		
PAF4-04000006	JUNTA			GASKET	GUARNIZIONE	JOINT	1		
	RECKITF6A			NGKBR6HS-10	BUJÍA	SPARK PLUG	CANDELE	BOUGIE	x 2
				PAF4-04070003	ANODO	ANODE	ANODO	ANODE	1
		PAJASOF40431-025	TÓRICA	O-RING	O-RING	JOINT TORIQUE	1		
		PAGB/T3452.1-13X2	TÓRICA	O-RING	O-RING	JOINT TORIQUE	1		
		REC68T-24251-00	FILTRO COMBUSTIBLE	FUEL FILTER	FILTRO COMBUSTIBILE	FILTRE ESSENCE	1		
		PAF4-04000030	MUELLE DEL TUBO DE COMBUSTIBLE	SPRING, FUEL PIPE	MOLLA TUBO COMBUSTIBILE	COLLIER TUYAU DE CARBURANT	x 2		
		REC09168-12017	ARANDELA	WHASER	RONDELLA	RONDELLE	1		
		CM68T-45251-00A	ANODO	ANODE	ANODO	ANODE	1		
		REC90430-08020	JUNTA DESAGÜE	DRAIN GASKET	GUARNIZIONE DRENAGGIO	JOINT DE VIDANGE	x 2		
		REC91490-30025	PIN BLOQUEADOR	COTTER PIN	COPPIGLIA	GOUPILLE	1		
		REC68T-W0078-00	KIT BOMBA DE AGUA	WATER PUMP REPAIR KIT	KIT POMPA DELL'ACQUA	KIT POMPE À EAU	1		
			RECKITF6C	NGKCR6HSB	BUJÍA	SPARK PLUG	CANDELE	BOUGIE	1
				PAF4-04000011	JUNTA	GASKET	GUARNIZIONE	JOINT	1
				PAF4-04070003	ANODO	ANODE	ANODO	ANODE	1
REC68T-24251-00	FILTRO COMBUSTIBLE			FUEL FILTER	FILTRO COMBUSTIBILE	FILTRE ESSENCE	1		
REC90430-08020	JUNTA DESAGÜE			DRAIN GASKET	GUARNIZIONE DRENAGGIO	JOINT DE VIDANGE	x 2		
CM6L5-45251-02A	ANODO			ANODE	ANODO	ANODE	1		
PAF4-04000006	JUNTA			GASKET	GUARNIZIONE	JOINT	1		
PAJASOF40431-025	TÓRICA			O-RING	O-RING	JOINT TORIQUE	1		
PAF4-03000018	JUNTA			GASKET	GUARNIZIONE	JOINT	1		
PAF4-03060000	TURBINA			IMPELLER	GIRANTE	TURBINE	1		
PAF4-03000016	PIN			PIN	PIN	PIN	1		
PAGB/T91-1.6X12	PIN BLOQUEADOR			COTTER PIN	COPPIGLIA	GOUPILLE	1		





	KIT	REF								
	RECKITFT8D	FT8 D/G (2001-14)	NGKBR6HS-10	BUJÍA	SPARK PLUG	CANDELE	BOUGIE	x 2		
		FT9.9G (2008-12)	PAF4-04070003	ANODO	ANODE	ANODO	ANODO	1		
		FT9.9J (2013 +)	PAJASOF40431-025	TÓRICA	O-RING	O-RING	JOINT TORIQUE	1		
			PAGB/T3452.1-13X2	TÓRICA	O-RING	O-RING	JOINT TORIQUE	1		
			REC68T-24251-00	FILTRO COMBUSTIBLE	FUEL FILTER	FILTRO COMBUSTIBILE	FILTRE ESSENCE	1		
			PAF4-04000030	MUELLE DEL TUBO DE COMBUSTIBLE	SPRING, FUEL PIPE	MOLLA TUBO COMBUSTIBILE	COLLIER TUYAU DE CARBURANT	x 2		
			REC09168-12017	ARANDELA	WHASER	RONDELLA	RONDELLE	1		
			CM68T-45251-00A	ANODO	ANODE	ANODO	ANODO	1		
			REC90430-08020	JUNTA DESAGÜE	DRAIN GASKET	GUARNIZIONE DRENAGGIO	JOINT DE VIDANGE	x 2		
			REC91490-30025	PIN BLOQUEADOR	COTTER PIN	COPPIGLIA	GOUPILLE	1		
			CM61N-45251-01A	ANODO	ANODE	ANODO	ANODO	1		
			REC68T-W0078-00	KIT BOMBA DE AGUA	WATER PUMP REPAIR KIT	KIT POMPA DELL'ACQUA	KIT POMPE À EAU	1		
			CM6E0-45251-11A	ANODO	ANODE	ANODO	ANODO	1		
			RECKITF9.9C	F9.9C (1998-08)	REC5GH-13440-00	FILTRO DE ACEITE	OIL FILTER	FILTRO OLIO	FILTRE D'HUILE	1
				F15A (1998-07)	CM66M-11325-00A	ANODO	ANODE	ANODO	ANODE	1
	PAF15-07010009			ALOJAMIENTO DEL ANODO	SEAL ANODE	ALLOGGIAMENTO ANODO	JOINT D'ANODE	1		
	CM15026A			ANODO	ANODE	ANODO	ANODE	1		
	PAF15-07010018			JUNTA	GASKET	GUARNIZIONE	JOINT	1		
	PAJASOF40431-025			TÓRICA	O-RING	O-RING	JOINT TORIQUE	1		
	NGKDR6EA-9			BUJÍA	SPARK PLUG	CANDELE	BOUGIE	x 2		
	REC61N-24563-10			FILTRO COMBUSTIBLE	FUEL FILTER	FILTRO COMBUSTIBILE	FILTRE ESSENCE	1		
	PAGB/T3452.1-32.5X1.8			ARANDELA	WHASER	RONDELLA	RONDELLE	1		
	PAF15-04000003			ARANDELA	WHASER	RONDELLA	RONDELLE	1		
	REC90430-08020			JUNTA DESAGÜE	DRAIN GASKET	GUARNIZIONE DRENAGGIO	JOINT DE VIDANGE	x 2		
	CM61N-45251-01A			ANODO	ANODE	ANODO	ANODO	1		
	TEN01136			ANODO	ANODE	ANODO	ANODO	1		
	REC91490-30025			PIN BLOQUEADOR	COTTER PIN	COPPIGLIA	GOUPILLE	1		
	RECKITF15C			F15C (2007+)	CM6G8-11325-00A	ANODO	ANODE	ANODO	ANODO	x 3
			PAF20-05000702	JUNTA	GASKET	GUARNIZIONE	JOINT	1		
			PAGB/T3452.1-13X2	JUNTA	GASKET	GUARNIZIONE	JOINT	1		
			REC5GH-13440-60	FILTRO DE ACEITE	OIL FILTER	FILTRO OLIO	FILTRE D'HUILE	1		
			PAJASOF40431-025	TÓRICA	O-RING	O-RING	JOINT TORIQUE	1		
			NGKDR6EB-9	BUJÍA	SPARK PLUG	CANDELE	BOUGIE	x 2		
			PAF15-07010018	JUNTA	GASKET	GUARNIZIONE	JOINT	1		
			REC93210-32738	TÓRICA	O-RING	O-RING	JOINT TORIQUE	1		
			CM6E0-45251-11A	ANODO	ANODE	ANODO	ANODO	1		
			PAF15-04000003	JUNTA	GASKET	GUARNIZIONE	JOINT	1		
			TEN01154AL	ANODO	ANODE	ANODO	ANODO	1		
			REC91490-30025	PIN BLOQUEADOR	COTTER PIN	COPPIGLIA	GOUPILLE	1		
			REC90430-08020	JUNTA DESAGÜE	DRAIN GASKET	GUARNIZIONE DRENAGGIO	JOINT DE VIDANGE	x 2		
			REC6AH-W0078-00	KIT BOMBA DE AGUA	WATER PUMP REPAIR KIT	KIT POMPA DELL'ACQUA	KIT POMPE À EAU	1		
			RECKITF20A	F20A (1998-09)	REC5GH-13440-00	FILTRO DE ACEITE	OIL FILTER	FILTRO OLIO	FILTRE D'HUILE	1
	CM62Y-11325-00A			ANODO	ANODE	ANODO	ANODE	x 2		
	PAF15-07010009			ALOJAMIENTO DEL ANODO	SEAL ANODE	ALLOGGIAMENTO ANODO	JOINT D'ANODE	x 2		
	PAJASOF40431-025			TÓRICA	O-RING	O-RING	JOINT TORIQUE	1		
	REC40145			FILTRO COMBUSTIBLE	FUEL FILTER	FILTRO COMBUSTIBILE	FILTRE ESSENCE	1		
	PAF4-04000030			MUELLE DEL TUBO DE COMBUSTIBLE	SPRING, FUEL PIPE	MOLLA TUBO COMBUSTIBILE	COLLIER TUYAU DE CARBURANT	x 2		
	CM6E0-45251-11A			ANODO	ANODE	ANODO	ANODO	1		
	PAF15-04000003			ARANDELA	WHASER	RONDELLA	RONDELLE	1		
	CM61N-45251-01A			ANODO	ANODE	ANODO	ANODO	1		
	REC90430-08020			JUNTA DESAGÜE	DRAIN GASKET	GUARNIZIONE DRENAGGIO	JOINT DE VIDANGE	x 2		
	PAGB/T91-1.6X12			PIN BLOQUEADOR	COTTER PIN	COPPIGLIA	GOUPILLE	1		
	NGKDR6EA-9			BUJÍA	SPARK PLUG	CANDELE	BOUGIE	x 2		
	REC61N-W0078-11			KIT BOMBA DE AGUA	WATER PUMP REPAIR KIT	KIT POMPA DELL'ACQUA	KIT POMPE À EAU	1		
	RECKITF20B			F20B (2007+)	PAF4-04070003	ANODO	ANODE	ANODO	ANODO	x 3
					REC6AH-12411-00	TERMOSTATO	THERMOSTAT	TERMOSTATO	THERMOSTAT	1
			PAF20-05000702	JUNTA	GASKET	GUARNIZIONE	JOINT	1		
			CM15026A	ANODO	ANODE	ANODO	ANODO	1		
			REC5GH-13440-60	FILTRO DE ACEITE	OIL FILTER	FILTRO OLIO	FILTRE D'HUILE	1		
			NGKDR6EB-9	BUJÍA	SPARK PLUG	CANDELE	BOUGIE	x 2		
			REC61N-24563-10	FILTRO COMBUSTIBLE	FUEL FILTER	FILTRO COMBUSTIBILE	FILTRE ESSENCE	1		
			REC93210-32738	TÓRICA	O-RING	O-RING	JOINT TORIQUE	1		
			PAF15-04000003	ARANDELA	WHASER	RONDELLA	RONDELLE	1		
			REC90430-08020	JUNTA DESAGÜE	DRAIN GASKET	GUARNIZIONE DRENAGGIO	JOINT DE VIDANGE	x 2		
			TEN01154AL	ANODO	ANODE	ANODO	ANODO	1		
			REC6AH-W0078-00	KIT BOMBA DE AGUA	WATER PUMP REPAIR KIT	KIT POMPA DELL'ACQUA	KIT POMPE À EAU	1		





	KIT	REF							
	RECKITF25A	REC5GH-13440-00	FILTRO DE ACEITE	OIL FILTER	FILTRO OLIO	FILTRE À HUILE	1		
		PAF15-07000031	TERMOSTATO	THERMOSTAT	TERMOSTATO	THERMOSTAT	1		
		PAF15-07010022	JUNTA	GASKET	GUARNIZIONE	JOINT	1		
		CM62Y-11325-00A	ANODO	ANODE	ANODO	ANODO	x 3		
		PAF15-07010009	ALOJAMIENTO DEL ANODO	SEAL ANODE	ALLOGGIAMENTO ANODO	JOINT D'ANODE	x 2		
		REC61N-24563-10	FILTRO COMBUSTIBLE	FUEL FILTER	FILTRO COMBUSTIBILE	FILTRE ESSENCE	1		
		REC93210-32738	TÓRICA	O-RING	O-RING	JOINT TORIQUE	1		
		NGKDPR6EA-9	BUJÍA	SPARK PLUG	CANDELE	BOUGIE	x 2		
		CM6E0-45251-11A	ANODO	ANODE	ANODO	ANODO	1		
		PAF15-04000003	ARANDELA	WHASER	RONDELLA	RONDELLE	1		
		CM61N-45251-01A	ANODO	ANODE	ANODO	ANODO	1		
		REC90430-08020	JUNTA DESAGÜE	DRAIN GASKET	GUARNIZIONE DRENAGGIO	JOINT DE VIDANGE	x 2		
		PAGB/T91-1.6X12	PIN BLOQUEADOR	COTTER PIN	COPPIGLIA	GOUPILLE	1		
		REC61N-W0078-11	KIT BOMBA DE AGUA	WATER PUMP REPAIR KIT	KIT POMPA DELL'ACQUA	KIT POMPE À EAU	1		
			RECKITFT25B	REC5GH-13440-00	FILTRO DE ACEITE	OIL FILTER	FILTRO OLIO	FILTRE À HUILE	1
				PAF15-07000031	TERMOSTATO	THERMOSTAT	TERMOSTATO	THERMOSTAT	1
PAF15-07010022	JUNTA			GASKET	GUARNIZIONE	JOINT	1		
CM62Y-11325-00A	ANODO			ANODE	ANODO	ANODO	x 3		
PAF15-07010009	ALOJAMIENTO DEL ANODO			SEAL ANODE	ALLOGGIAMENTO ANODO	JOINT D'ANODE	x 2		
REC61N-24563-10	FILTRO COMBUSTIBLE			FUEL FILTER	FILTRO COMBUSTIBILE	FILTRE ESSENCE	1		
REC93210-32738	TÓRICA			O-RING	O-RING	JOINT TORIQUE	1		
NGKDPR6EA-9	BUJÍA			SPARK PLUG	CANDELE	BOUGIE	x 2		
CM6E0-45251-11A	ANODO			ANODE	ANODO	ANODO	1		
PAF15-04000003	ARANDELA			WHASER	RONDELLA	RONDELLE	1		
CM67C-45371-00A	ANODO			ANODE	ANODO	ANODO	1		
REC90430-08020	JUNTA DESAGÜE			DRAIN GASKET	GUARNIZIONE DRENAGGIO	JOINT DE VIDANGE	x 2		
PAGB/T91-1.6X12	PIN BLOQUEADOR			COTTER PIN	COPPIGLIA	GOUPILLE	1		
REC66T-W0078-00	KIT BOMBA DE AGUA			WATER PUMP REPAIR KIT	KIT POMPA DELL'ACQUA	KIT POMPE À EAU	1		
CM67C-45251-00A	ANODO			ANODE	ANODO	ANODO	1		
	RECKITF25G			PAF4-04070003	ANODO	ANODE	ANODO	ANODE	x 4
		REC6FM-12411-00	TERMOSTATO	THERMOSTAT	TERMOSTATO	THERMOSTAT	1		
		REC5GH-13440-60	FILTRO ACEITE	OIL FILTER	FILTRO OLIO	FILTRE À HUILE	1		
		NGKDPR6EB-9	BUJÍA	SPARK PLUG	CANDELE	BOUGIE	x 2		
		REC6D8-WS24A-00	FILTRO COMBUSTIBLE	FUEL FILTER	FILTRO COMBUSTIBILE	FILTRE ESSENCE	1		
		PAGB/T3452.1-32.5X1.8	TÓRICA	O-RING	O-RING	JOINT TORIQUE	1		
		PAF4-04000006	ARANDELA	WHASER	RONDELLA	RONDELLE	1		
		PAF15-04000003	ARANDELA	WHASER	RONDELLA	RONDELLE	1		
		CM6E5-45251-00A	ANODO	ANODE	ANODO	ANODE	1		
		CM664-45371-01A	ANODO	ANODE	ANODO	ANODE	1		
		REC90430-08020	JUNTA DESAGÜE	DRAIN GASKET	GUARNIZIONE DRENAGGIO	JOINT DE VIDANGE	x 2		
		PAF25-04050004	GOMA SELLO DE AGUA	DAMPER WATER PIPE	AMMORTIZZATORE, TUBO DELL'ACQUA	MANCHON TUYAU D'EAU	1		
		REC6L2-44352-00	TURBINA	IMPELLER	GIRANTE	TURBINE	1		
		PAF25-04050003	TÓRICA	O-RING	O-RING	JOINT TORIQUE	1		
		PAGB/T91-1.6X12	PIN BLOQUEADOR	COTTER PIN	COPPIGLIA	GOUPILLE	1		
			RECKITF25D	PAF15-07000031	TERMOSTATO	THERMOSTAT	TERMOSTATO	THERMOSTAT	1
PAF15-07010022	JUNTA			GASKET	GUARNIZIONE	JOINT	1		
PAF4-04070003	ANODO			ANODE	ANODO	ANODE	1		
REC5GH-13440-60	FILTRO ACEITE			OIL FILTER	FILTRO OLIO	FILTRE À HUILE	1		
CM6BL-11325-00A	ANODO			ANODE	ANODO	ANODE	x 2		
NGKDPR6EB-9	BUJÍA			SPARK PLUG	CANDELE	BOUGIE	x 2		
REC61N-24563-10	FILTRO COMBUSTIBLE			FUEL FILTER	FILTRO COMBUSTIBILE	FILTRE ESSENCE	1		
PAGB/T3452.1-32.5X1.8	TÓRICA			O-RING	O-RING	JOINT TORIQUE	1		
CM62Y-11325-00A	ANODO			ANODE	ANODO	ANODE	1		
PAF15-04000003	ARANDELA			WHASER	RONDELLA	RONDELLE	1		
REC90430-08020	JUNTA DESAGÜE			DRAIN GASKET	GUARNIZIONE DRENAGGIO	JOINT DE VIDANGE	x 2		
CM61N-45251-01A	ANODO			ANODE	ANODO	ANODE	1		
REC61N-W0078-11	KIT BOMBA DE AGUA			WATER PUMP REPAIR KIT	KIT POMPA DELL'ACQUA	KIT POMPE À EAU	1		
PAGB/T91-1.6X12	PIN BLOQUEADOR			COTTER PIN	COPPIGLIA	GOUPILLE	1		
	RECKITFT25F			PAF15-07000031	TERMOSTATO	THERMOSTAT	TERMOSTATO	THERMOSTAT	1
				PAF15-07010022	JUNTA	GASKET	GUARNIZIONE	JOINT	1
		PAF4-04070003	ANODO	ANODE	ANODO	ANODE	1		
		REC5GH-13440-60	FILTRO ACEITE	OIL FILTER	FILTRO OLIO	FILTRE À HUILE	1		
		CM6BL-11325-00A	ANODO	ANODE	ANODO	ANODE	x 2		
		NGKDPR6EB-9	BUJÍA	SPARK PLUG	CANDELE	BOUGIE	x 2		
		REC61N-24563-10	FILTRO COMBUSTIBLE	FUEL FILTER	FILTRO COMBUSTIBILE	FILTRE ESSENCE	1		
		PAGB/T3452.1-32.5X1.8	TÓRICA	O-RING	O-RING	JOINT TORIQUE	1		
		CM6E0-45251-11A	ANODO	ANODE	ANODO	ANODE	1		
		CM62Y-11325-00A	ANODO	ANODE	ANODO	ANODE	1		
		PAF15-04000003	ARANDELA	WHASER	RONDELLA	RONDELLE	1		
		REC90430-08020	JUNTA DESAGÜE	DRAIN GASKET	GUARNIZIONE DRENAGGIO	JOINT DE VIDANGE	x 2		
		CM67C-45371-00A	ANODO	ANODE	ANODO	ANODE	1		
		PAGB/T91-1.6X12	PIN BLOQUEADOR	COTTER PIN	COPPIGLIA	GOUPILLE	1		
		CM67C-45251-00A	ANODO	ANODE	ANODO	ANODE	1		
		REC66T-W0078-00	KIT BOMBA DE AGUA	WATER PUMP REPAIR KIT	KIT POMPA DELL'ACQUA	KIT POMPE À EAU	1		







	KIT	REF					
	RECKITF30A	PAF15-07000031	TERMOSTATO	THERMOSTAT	TERMOSTATO	THERMOSTAT	1
		PAF15-07010022	JUNTA	GASKET	GUARNIZIONE	JOINT	1
		NGKDPR6EA-9	BUJÍA	SPARK PLUG	CANDELE	BOUGIE	x 3
		REC5GH-13440-00	FILTRO ACEITE	OIL FILTER	FILTRO OLIO	FILTRE À HUILE	1
		CM62Y-11325-00A	ANODO	ANODE	ANODO	ANODE	x 4
		PAF15-07010009	ALOJAMIENTO DEL ANODO	SEAL ANODE	ALLOGGIAMENTO ANODO	JOINT D'ANODE	x 4
		REC40145	FILTRO COMBUSTIBLE	FUEL FILTER	FILTRO COMBUSTIBILE	FILTRE ESSENCE	1
		PAF4-04000030	MUELLE DEL TUBO DE COMBUSTIBLE	SPRING, FUEL PIPE	MOLLA TUBO COMBUSTIBILE	COLLIER TUYAU DE CARBURANT	x 2
		CM688-45251-01A	ANODO	ANODE	ANODO	ANODE	1
		PAF15-04000003	ARANDELA	WHASER	RONDELLA	RONDELLE	1
		REC90430-08020	JUNTA DESAGÜE	DRAIN GASKET	GUARNIZIONE DRENAGGIO	JOINT DE VIDANGE	x 2
		CM67C-45251-00A	ANODO	ANODE	ANODO	ANODE	1
		CM67C-45371-00A	ANODO	ANODE	ANODO	ANODE	1
		REC91490-30025	PIN BLOQUEADOR	COTTER PIN	COPPIGLIA	GOUPILLE	1
		REC66T-W0078-00	KIT BOMBA DE AGUA	WATER PUMP REPAIR KIT	KIT POMPA DELL'ACQUA	KIT POMPE À EAU	1
			RECKITF30B	PAF15-07000031	TERMOSTATO	THERMOSTAT	TERMOSTATO
PAF15-07010022	JUNTA			GASKET	GUARNIZIONE	JOINT	1
PAF4-04070003	ANODO			ANODE	ANODO	ANODE	x 4
REC5GH-13440-60	FILTRO DE ACEITE			OIL FILTER	FILTRO OLIO	FILTRE À HUILE	1
NGKDPR6EB-9	BUJÍA			SPARK PLUG	CANDELE	BOUGIE	x 3
REC6BG-13915-00	FILTRO COMBUSTIBLE VST			FUEL FILTER VST	FILTRO COMBUSTIBILE VST	FILTRE ESSENCE VST	1
REC6C5-24251-00	FILTRO COMBUSTIBLE			FUEL FILTER	FILTRO COMBUSTIBILE	FILTRE ESSENCE	1
REC6D8-WS24A-00	FILTRO COMBUSTIBLE			FUEL FILTER	FILTRO COMBUSTIBILE	FILTRE ESSENCE	1
PAGB/T3452.1-32.5X1.8	TÓRICA			O-RING	O-RING	JOINT TORIQUE	1
CM6E0-45251-11A	ANODO			ANODE	ANODO	ANODE	1
CM688-45251-01A	ANODO			ANODE	ANODO	ANODE	1
CM62Y-11325-00A	ANODO			ANODE	ANODO	ANODE	1
PAF15-04000003	ARANDELA			WHASER	RONDELLA	RONDELLE	1
REC90430-08020	JUNTA DESAGÜE			DRAIN GASKET	GUARNIZIONE DRENAGGIO	JOINT DE VIDANGE	x 2
CM67C-45371-00A	ANODO			ANODE	ANODO	ANODE	1
CM67C-45251-00A	ANODO			ANODE	ANODO	ANODE	1
REC6BG-W0078-00	KIT BOMBA DE AGUA	WATER PUMP REPAIR KIT	KIT POMPA DELL'ACQUA	KIT POMPE À EAU	1		
REC91490-30025	PIN BLOQUEADOR	COTTER PIN	SPINOTTO	PIN	1		
	RECKITF40B	PAF15-07000031	TERMOSTATO	THERMOSTAT	TERMOSTATO	THERMOSTAT	1
		PAF15-07010022	JUNTA	GASKET	GUARNIZIONE	JOINT	1
		REC3FV-13440-00	FILTRO DE ACEITE	OIL FILTER	FILTRO OLIO	FILTRE À HUILE	1
		CM62Y-11325-00A	ANODO	ANODE	ANODO	ANODE	x 3
		PAF15-07010009	ALOJAMIENTO DEL ANODO	SEAL ANODE	ALLOGGIAMENTO ANODO	JOINT D'ANODE	x 3
		NGKDPR6EA-9	BUJÍA	SPARK PLUG	CANDELE	BOUGIE	x 3
		REC40145	FILTRO COMBUSTIBLE	FUEL FILTER	FILTRO COMBUSTIBILE	FILTRE ESSENCE	1
		PAF4-04000030	MUELLE DEL TUBO DE COMBUSTIBLE	SPRING, FUEL PIPE	MOLLA TUBO COMBUSTIBILE	COLLIER TUYAU DE CARBURANT	x 2
		CM688-45251-01A	ANODO	ANODE	ANODO	ANODE	1
		CM6E0-45251-11A	ANODO	ANODE	ANODO	ANODE	1
		PAF15-04000003	ARANDELA	WHASER	RONDELLA	RONDELLE	1
		REC90430-08020	JUNTA DESAGÜE	DRAIN GASKET	GUARNIZIONE DRENAGGIO	JOINT DE VIDANGE	x 2
		CM67C-45371-00A	ANODO	ANODE	ANODO	ANODE	1
		CM67C-45251-00A	ANODO	ANODE	ANODO	ANODE	1
		REC91490-30025	PIN BLOQUEADOR	COTTER PIN	COPPIGLIA	GOUPILLE	1
		REC66T-W0078-00	KIT BOMBA DE AGUA	WATER PUMP REPAIR KIT	KIT POMPA DELL'ACQUA	KIT POMPE À EAU	1
	RECKITF50A	PAF15-07000031	TERMOSTATO	THERMOSTAT	TERMOSTATO	THERMOSTAT	1
		PAF15-07010022	JUNTA	GASKET	GUARNIZIONE	JOINT	1
		PAF4-04070003	ANODO	ANODE	ANODO	ANODO	x 4
		REC5GH-13440-60	FILTRO DE ACEITE	OIL FILTER	FILTRO OLIO	FILTRE À HUILE	1
		NGKDPR6EB-9	BUJÍA	SPARK PLUG	CANDELE	BOUGIE	x 4
		REC6BG-13915-00	FILTRO COMBUSTIBLE VST	FUEL FILTER VST	FILTRO COMBUSTIBILE VST	FILTRE VST	1
		REC6C5-24251-00	FILTRO COMBUSTIBLE	FUEL FILTER	FILTRO COMBUSTIBILE	FILTRE ESSENCE	1
		REC6D8-WS24A-00	FILTRO COMBUSTIBLE	FUEL FILTER	FILTRO COMBUSTIBILE	FILTRE ESSENCE	1
		PAGB/T3452.1-32.5X1.8	TÓRICA	O-RING	O-RING	JOINT TORIQUE	1
		CM6E0-45251-11A	ANODO	ANODE	ANODO	ANODE	1
		CM688-45251-01A	ANODO	ANODE	ANODO	ANODE	1
		CM62Y-11325-00A	ANODO	ANODE	ANODO	ANODE	1
		PAF15-04000003	ARANDELA	WHASER	RONDELLA	RONDELLE	1
		REC90430-08020	JUNTA DESAGÜE	DRAIN GASKET	GUARNIZIONE DRENAGGIO	JOINT DE VIDANGE	x 2
		CM67C-45371-00A	ANODO	ANODE	ANODO	ANODE	1
		CM67C-45251-00A	ANODO	ANODE	ANODO	ANODE	1
REC6BG-W0078-00	KIT BOMBA DE AGUA	WATER PUMP REPAIR KIT	KIT POMPA DELL'ACQUA	KIT POMPE À EAU	1		
REC91490-30025	PIN BLOQUEADOR	COTTER PIN	COPPIGLIA	GOUPILLE	1		





	KIT	REF					
	RECKITFT50B	PAF15-07000031	TERMOSTATO	THERMOSTAT	TERMOSTATO	THERMOSTAT	1
		PAF15-07010022	JUNTA	GASKET	GUARNIZIONE	JOINT	1
		REC5GH-13440-00	FILTRO DE ACEITE	OIL FILTER	FILTRO OLIO	FILTRE À HUILE	1
		CM62Y-11325-00A	ANODO	ANODE	ANODO	ANODE	x 5
		PAF15-07010009	ALOJAMIENTO DEL ANODO	SEAL ANODE	ALLOGGIAMENTO ANODO	JOINT D'ANODE	x 5
		NGKDP6EA-9	BUJÍA	SPARK PLUG	CANDELE	BOUGIE	x 4
		REC68V-24563-00	FILTRO COMBUSTIBLE	FUEL FILTER	FILTRO COMBUSTIBILE	FILTRE	1
		REC93210-32738	TÓRICA	O-RING	O-RING	JOINT TORIQUE	1
		CM6E0-45251-11A	ANODO	ANODE	ANODO	ANODE	x 3
		PAF15-04000003	ARANDELA	WHASER	RONDELLA	RONDELLE	1
		REC90430-08020	JUNTA DESAGÜE	DRAIN GASKET	GUARNIZIONE DRENAGGIO	JOINT DE VIDANGE	x 2
		CM67F-45371-00A	ANODO	ANODE	ANODO	ANODE	1
		REC91490-40030	PIN BLOQUEADOR	COTTER PIN	COPPIGLIA	GOUPILLE	1
		REC6H3-W0078-02	KIT BOMBA DE AGUA	WATER PUMP REPAIR KIT	KIT POMPA DELL'ACQUA	KIT POMPE À EAU	1
			RECKITFT50C	PAF15-07000031	TERMOSTATO	THERMOSTAT	TERMOSTATO
PAF15-07010022	JUNTA			GASKET	GUARNIZIONE	JOINT	1
CM62Y-11325-00A	ANODO			ANODE	ANODO	ANODE	x 5
PAF15-07010009	ALOJAMIENTO DEL ANODO			SEAL ANODE	ALLOGGIAMENTO ANODO	JOINT D'ANODE	x 5
NGKDP6EA-9	BUJÍA			SPARK PLUG	CANDELE	BOUGIE	x 4
REC5GH-13440-00	FILTRO DE ACEITE			OIL FILTER	FILTRO OLIO	FILTRE À HUILE	1
REC61N-24563-10	FILTRO COMBUSTIBLE			FUEL FILTER	FILTRO COMBUSTIBILE	FILTRE ESSENCE	1
PAGB/T3452.1-32.5X1.8	TÓRICA			O-RING	O-RING	JOINT TORIQUE	1
CM6E0-45251-11A	ANODO			ANODE	ANODO	ANODE	x 3
PAF15-04000003	ARANDELA			WHASER	RONDELLA	RONDELLE	1
REC90430-08020	JUNTA DESAGÜE			DRAIN GASKET	GUARNIZIONE DRENAGGIO	JOINT DE VIDANGE	x 2
CM67F-45371-00A	ANODO			ANODE	ANODO	ANODE	1
REC91490-40030	PIN BLOQUEADOR			COTTER PIN	COPPIGLIA	GOUPILLE	1
REC6H3-W0078-02	KIT BOMBA DE AGUA			WATER PUMP REPAIR KIT	KIT POMPA DELL'ACQUA	KIT POMPE À EAU	1
	RECKITF50F			PAF15-07000031	TERMOSTATO	THERMOSTAT	TERMOSTATO
		PAF15-07010022	JUNTA	GASKET	GUARNIZIONE	JOINT	1
		CM62Y-11325-00A	ANODO	ANODE	ANODO	ANODE	x 5
		PAF15-07010009	ALOJAMIENTO DEL ANODO	SEAL ANODE	ALLOGGIAMENTO ANODO	JOINT D'ANODE	x 5
		REC5GH-13440-00	FILTRO DE ACEITE	OIL FILTER	FILTRO OLIO	FILTRE À HUILE	1
		NGKDP6EB-9	BUJÍA	SPARK PLUG	CANDELE	BOUGIE	x 4
		REC6C5-13915-00	FILTRO COMBUSTIBLE VST	FUEL FILTER VST	FILTRO COMBUSTIBILE VST	FILTRE VST	1
		REC6C5-14984-00	TÓRICA VST	VST O-RING	O-RING VST	JOINT TORIQUE VST	1
		REC6C5-24251-00	FILTRO COMBUSTIBLE	FUEL FILTER	FILTRO COMBUSTIBILE	FILTRE ESSENCE	1
		REC68V-24563-00	FILTRO COMBUSTIBLE	FUEL FILTER	FILTRO COMBUSTIBILE	FILTRE ESSENCE	1
		REC93210-32738	TÓRICA	O-RING	O-RING	JOINT TORIQUE	1
		CM6E0-45251-11A	ANODO	ANODE	ANODO	ANODE	x 2
		CM688-45251-01A	ANODO	ANODE	ANODO	ANODE	1
		PAF15-04000003	ARANDELA	WHASER	RONDELLA	RONDELLE	1
		REC90430-08020	JUNTA DESAGÜE	DRAIN GASKET	GUARNIZIONE DRENAGGIO	JOINT DE VIDANGE	x 2
CM67C-45371-00A	ANODO	ANODE	ANODO	ANODE	1		
CM67C-45251-00A	ANODO	ANODE	ANODO	ANODE	1		
REC91490-30025	PIN BLOQUEADOR	COTTER PIN	COPPIGLIA	GOUPILLE	1		
REC63D-W0078-01	KIT BOMBA DE AGUA	WATER PUMP REPAIR KIT	KIT POMPA DELL'ACQUA	KIT POMPE À EAU	1		
	RECKITFT50G	PAF15-07000031	TERMOSTATO	THERMOSTAT	TERMOSTATO	THERMOSTAT	1
		PAF15-07010022	JUNTA	GASKET	GUARNIZIONE	JOINT	1
		REC5GH-13440-60	FILTRO DE ACEITE	OIL FILTER	FILTRO OLIO	FILTRE À HUILE	1
		CM62Y-11325-00A	ANODO	ANODE	ANODO	ANODE	1
		PAF15-07010009	ALOJAMIENTO DEL ANODO	SEAL ANODE	ALLOGGIAMENTO ANODO	JOINT D'ANODE	1
		NGKDP6EB-9	BUJÍA	SPARK PLUG	CANDELE	BOUGIE	x 4
		PAF4-04070003	ANODO	ANODE	ANODO	ANODE	x 4
		PAGB/T3452.1-13X2	TÓRICA	O-RING	O-RING	JOINT TORIQUE	x 4
		REC6C5-13915-00	FILTRO COMBUSTIBLE VST	FUEL FILTER VST	FILTRO COMBUSTIBILE VST	FILTRE ESSENCE VST	1
		REC6C5-14984-00	TÓRICA VST	VST O-RING	O-RING VST	JOINT TORIQUE VST	1
		REC6C5-24251-00	FILTRO COMBUSTIBLE	FUEL FILTER	FILTRO COMBUSTIBILE	FILTRE ESSENCE	1
		REC6D8-WS24A-00	FILTRO COMBUSTIBLE	FUEL FILTER	FILTRO COMBUSTIBILE	FILTRE ESSENCE	1
		PAGB/T3452.1-32.5X1.8	TÓRICA	O-RING	O-RING	JOINT TORIQUE	1
		CM6E0-45251-11A	ANODO	ANODE	ANODO	ANODE	x 3
		PAF15-04000003	ARANDELA	WHASER	RONDELLA	RONDELLE	1
REC90430-08020	JUNTA DESAGÜE	DRAIN GASKET	GUARNIZIONE DRENAGGIO	JOINT DE VIDANGE	x 2		
CM67F-45371-00A	ANODO	ANODE	ANODO	ANODE	1		
REC91490-40030	PIN BLOQUEADOR	COTTER PIN	COPPIGLIA	GOUPILLE	1		
REC6H3-W0078-02	KIT BOMBA DE AGUA	WATER PUMP REPAIR KIT	KIT POMPA DELL'ACQUA	KIT POMPE À EAU	1		

	KIT	REF								
F50H (2013+) F60A (2002-07) F60C (2005-12) F60F (2013+)		RECKITF60A	PAF15-07010009	ALOJAMIENTO DEL ANODO	SEAL ANODE	ALLOGGIAMENTO ANODO	JOINT D'ANODE	1		
		REC5GH-13440-60	FILTRO DE ACEITE	OIL FILTER	FILTRO OLIO	FILTRE À HUILE	1			
		PAF4-04070003	ANODO	ANODE	ANODO	ANODE	x 4			
		PAGB/T3452.1-13X2	TÓRICA	O-RING	O-RING	JOINT TORIQUE	x 4			
		NGKDPR6EB-9	BUJÍA	SPARK PLUG	CANDELE	BOUGIE	x 4			
		REC6C5-13915-00	FILTRO COMBUSTIBLE VST	FUEL FILTER VST	FILTRO COMBUSTIBILE VST	FILTRE VST	1			
		REC6C5-14984-00	TÓRICA VST	VST O-RING	O-RING VST	JOINT TORIQUE VST	1			
		REC6C5-24251-00	FILTRO COMBUSTIBLE	FUEL FILTER	FILTRO COMBUSTIBILE	FILTRE ESSENCE	1			
		REC6D8-WS24A-00	FILTRO COMBUSTIBLE	FUEL FILTER	FILTRO COMBUSTIBILE	FILTRE ESSENCE	1			
		REC93210-32738	TÓRICA	O-RING	O-RING	JOINT TORIQUE	1			
		CM6E0-45251-11A	ANODO	ANODE	ANODO	ANODE	x 4			
		CM688-45251-01A	ANODO	ANODE	ANODO	ANODE	1			
		PAF15-04000003	ARANDELA	WHASER	RONDELLA	RONDELLE	1			
		REC90430-08020	JUNTA DESAGÜE	DRAIN GASKET	GUARNIZIONE DRENAGGIO	JOINT DE VIDANGE	x 2			
		CM67C-45371-00A	ANODO	ANODE	ANODO	ANODE	1			
		CM67C-45251-00A	ANODO	ANODE	ANODO	ANODE	1			
REC91490-30025	PIN BLOQUEADOR	COTTER PIN	COPPIGLIA	GOUPILLE	1					
REC63D-W0078-01	KIT BOMBA DE AGUA	WATER PUMP REPAIR KIT	KIT POMPA DELL'ACQUA	KIT POMPE À EAU	1					
FT60B (2003-06)		RECKITF60B	PAF15-07000031	TERMOSTATO	THERMOSTAT	TERMOSTATO	THERMOSTAT	1		
		PAF15-07010022	JUNTA	GASKET	GUARNIZIONE	JOINT	1			
		CM62Y-11325-00A	ANODO	ANODE	ANODO	ANODE	x 5			
		PAF15-07010009	ALOJAMIENTO DEL ANODO	SEAL ANODE	ALLOGGIAMENTO ANODO	JOINT D'ANODE	x 5			
		REC5GH-13440-60	FILTRO DE ACEITE	OIL FILTER	FILTRO OLIO	FILTRE À HUILE	1			
		NGKDPR5EA-9	BUJÍA	SPARK PLUG	CANDELE	BOUGIE	x 4			
		REC61N-24563-10	FILTRO COMBUSTIBLE	FUEL FILTER	FILTRO COMBUSTIBILE	FILTRE ESSENCE	1			
		PAGB/T3452.1-32.5X1.8	TÓRICA	O-RING	O-RING	JOINT TORIQUE	1			
		CM6E0-45251-11A	ANODO	ANODE	ANODO	ANODE	x 3			
		PAF15-04000003	ARANDELA	WHASER	RONDELLA	RONDELLE	1			
		REC90430-08020	JUNTA DESAGÜE	DRAIN GASKET	GUARNIZIONE DRENAGGIO	JOINT DE VIDANGE	x 2			
		CM67F-45371-00A	ANODO	ANODE	ANODO	ANODE	1			
		REC91490-40030	PIN BLOQUEADOR	COTTER PIN	COPPIGLIA	GOUPILLE	1			
		REC6H3-W0078-02	KIT BOMBA DE AGUA	WATER PUMP REPAIR KIT	KIT POMPA DELL'ACQUA	KIT POMPE À EAU	1			
		F70A (2011+)		RECKITF70A	PAF15-07000031	TERMOSTATO	THERMOSTAT	TERMOSTATO	THERMOSTAT	1
				PAF15-07010022	JUNTA	GASKET	GUARNIZIONE	JOINT	1	
CM62Y-11325-00A	ANODO			ANODE	ANODO	ANODE	1			
REC5GH-13440-60	FILTRO DE ACEITE			OIL FILTER	FILTRO OLIO	FILTRE À HUILE	1			
PAF4-04070003	ANODO			ANODE	ANODO	ANODE	x 3			
PAGB/T3452.1-13X2	TÓRICA			O-RING	O-RING	JOINT TORIQUE	x 3			
NGKLR7E	BUJÍA			SPARK PLUG	CANDELE	BOUGIE	x 4			
REC6C5-13915-00	FILTRO COMBUSTIBLE VST			FUEL FILTER VST	FILTRO COMBUSTIBILE VST	FILTRE ESSENCE VST	1			
REC6C5-24251-00	FILTRO COMBUSTIBLE			FUEL FILTER	FILTRO COMBUSTIBILE	FILTRE ESSENCE	1			
REC6D8-WS24A-00	FILTRO COMBUSTIBLE			FUEL FILTER	FILTRO COMBUSTIBILE	FILTRE ESSENCE	1			
REC93210-32738	TÓRICA			O-RING	O-RING	JOINT TORIQUE	1			
CM6E0-45251-11A	ANODO			ANODE	ANODO	ANODE	x 3			
PAF15-04000003	ARANDELA			WHASER	RONDELLA	RONDELLE	1			
REC90430-08020	JUNTA DESAGÜE			DRAIN GASKET	GUARNIZIONE DRENAGGIO	JOINT DE VIDANGE	x 2			
CM67F-45371-00A	ANODO			ANODE	ANODO	ANODE	1			
REC91490-30025	PIN BLOQUEADOR			COTTER PIN	COPPIGLIA	GOUPILLE	1			
REC6CJ-W0078-00	KIT BOMBA DE AGUA	WATER PUMP REPAIR KIT	KIT POMPA DELL'ACQUA	KIT POMPE À EAU	1					
F80A (2000-07) F100A (1997-07)		RECKITF80A	CM68V-11325-01A	ANODO	ANODE	ANODO	ANODE	x 2		
		REC5GH-13440-00	FILTRO DE ACEITE	OIL FILTER	FILTRO OLIO	FILTRE À HUILE	1			
		REC67F-12411-01	TERMOSTATO	THERMOSTAT	TERMOSTATO	THERMOSTAT	1			
		NGKLR5A-11	BUJÍA	SPARK PLUG	CANDELE	BOUGIE	x 4			
		PAJASOF40431-025	TÓRICA	O-RING	O-RING	JOINT TORIQUE	1			
		REC61N-24563-10	FILTRO COMBUSTIBLE	FUEL FILTER	FILTRO COMBUSTIBILE	FILTRE ESSENCE	1			
		PAGB/T3452.1-32.5X1.8	TÓRICA	O-RING	O-RING	JOINT TORIQUE	1			
		CM6H1-45251-02A	ANODO	ANODE	ANODO	ANODE	1			
		PAF15-04000003	ARANDELA	WHASER	RONDELLA	RONDELLE	1			
		REC91490-40030	PIN BLOQUEADOR	COTTER PIN	COPPIGLIA	GOUPILLE	1			
		REC90430-08020	JUNTA DESAGÜE	DRAIN GASKET	GUARNIZIONE DRENAGGIO	JOINT DE VIDANGE	x 2			
		REC67F-W0078-00	KIT BOMBA DE AGUA	WATER PUMP REPAIR KIT	KIT POMPA DELL'ACQUA	KIT POMPE À EAU	1			





	KIT	REF							
	RECKITF80B	CM15026A	ANODO	ANODE	ANODO	ANODE	x 3		
		CM67F-11325-01A	ANODO	ANODE	ANODO	ANODE	1		
		REC5GH-13440-00	FILTRO DE ACEITE	OIL FILTER	FILTRO OLIO	FILTRE À HUILE	1		
		CM67F-11325-01A	ANODO	ANODE	ANODO	ANODE	x 2		
		PAJASOF40431-025	TÓRICA	O-RING	O-RING	JOINT TORIQUE	1		
		REC67F-12411-01	TERMOSTATO	THERMOSTAT	TERMOSTATO	THERMOSTAT	1		
		NGKLF5A-11	BUJÍA	SPARK PLUG	CANDELE	BOUGIE	x 4		
		REC6C5-13915-00	FILTRO COMBUSTIBLE	FUEL FILTER	FILTRO COMBUSTIBILE	FILTRE ESSENCE	1		
		REC6C5-24251-00	FILTRO COMBUSTIBLE	FUEL FILTER	FILTRO COMBUSTIBILE	FILTRE ESSENCE	1		
		REC6D8-WS24A-00	FILTRO COMBUSTIBLE	FUEL FILTER	FILTRO COMBUSTIBILE	FILTRE ESSENCE	1		
		PAGB/T3452.1-32.5X1.8	TÓRICA	O-RING	O-RING	JOINT TORIQUE	1		
		CM6H1-45251-02A	ANODO	ANODE	ANODO	ANODE	1		
		PAF15-04000003	ARANDELA	WHASER	RONDELLA	RONDELLE	1		
		REC90430-08020	JUNTA DESAGÜE	DRAIN GASKET	GUARNIZIONE DRENAGGIO	JOINT DE VIDANGE	x 2		
		CM67F-45371-00	ANODO	ANODE	ANODO	ANODE	1		
		REC91490-40030	PIN BLOQUEADOR	COTTER PIN	COPPIGLIA	GOUPILLE	1		
		REC67F-W0078-00	KIT BOMBA DE AGUA	WATER PUMP REPAIR KIT	KIT POMPA DELL'ACQUA	KIT POMPE À EAU	1		
			RECKITF100D	CM15026A	ANODO	ANODE	ANODO	ANODE	x 3
REC5GH-13440-00	FILTRO DE ACEITE			OIL FILTER	FILTRO OLIO	FILTRE À HUILE	1		
CM67F-11325-01A	ANODO			ANODE	ANODO	ANODE	x 3		
PAJASOF40431-025	TÓRICA			O-RING	O-RING	JOINT TORIQUE	1		
REC6D9-12411-00	TERMOSTATO			THERMOSTAT	TERMOSTATO	THERMOSTAT	1		
NGKLF5A-11	BUJÍA			SPARK PLUG	CANDELE	BOUGIE	x 4		
REC6C5-13915-00	FILTRO COMBUSTIBLE			FUEL FILTER	FILTRO COMBUSTIBILE	FILTRE ESSENCE	1		
REC6C5-24251-00	FILTRO COMBUSTIBLE			FUEL FILTER	FILTRO COMBUSTIBILE	FILTRE ESSENCE	1		
REC6D8-WS24A-00	FILTRO COMBUSTIBLE			FUEL FILTER	FILTRO COMBUSTIBILE	FILTRE ESSENCE	1		
PAGB/T3452.1-32.5X1.8	TÓRICA			O-RING	O-RING	JOINT TORIQUE	1		
CM6H1-45251-02A	ANODO			ANODE	ANODO	ANODE	1		
PAF15-04000003	ARANDELA			WHASER	RONDELLA	RONDELLE	1		
REC90430-08020	JUNTA DESAGÜE			DRAIN GASKET	GUARNIZIONE DRENAGGIO	JOINT DE VIDANGE	x 2		
CM67F-45371-00	ANODO			ANODE	ANODO	ANODE	1		
REC91490-40030	PIN BLOQUEADOR			COTTER PIN	SPINOTTO	PIN	1		
REC67F-W0078-00	KIT BOMBA DE AGUA			WATER PUMP REPAIR KIT	KIT POMPA DELL'ACQUA	KIT POMPE À EAU	1		
	RECKITF100F			PAF4-04070003	ANODO	ANODE	ANODO	ANODE	x 4
				PAGB/T3452.1-13X2	TÓRICA	O-RING	O-RING	JOINT TORIQUE	x 4
		CM63P-11325-01A	ANODO	ANODE	ANODO	ANODE	1		
		REC5GH-13440-00	FILTRO DE ACEITE	OIL FILTER	FILTRO OLIO	FILTRE À HUILE	1		
		REC6FP-12411-00	TERMOSTATO	THERMOSTAT	TERMOSTATO	THERMOSTAT	1		
		NGKLR6E-9N	BUJÍA	SPARK PLUG	CANDELE	BOUGIE	x 4		
		TENO1165	ANODO	ANODE	ANODO	ANODE	1		
		REC6C5-24251-00	FILTRO COMBUSTIBLE	FUEL FILTER	FILTRO COMBUSTIBILE	FILTRE ESSENCE	1		
		REC6D8-WS24A-00	FILTRO COMBUSTIBLE	FUEL FILTER	FILTRO COMBUSTIBILE	FILTRE ESSENCE	1		
		PAGB/T3452.1-32.5X1.8	TÓRICA	O-RING	O-RING	JOINT TORIQUE	1		
		CM6H1-45251-02A	ANODO	ANODE	ANODO	ANODE	1		
		PAF15-04000003	ARANDELA	WHASER	RONDELLA	RONDELLE	1		
		REC90430-08020	JUNTA DESAGÜE	DRAIN GASKET	GUARNIZIONE DRENAGGIO	JOINT DE VIDANGE	x 2		
		CM6E5-45371-01A	ANODO	ANODE	ANODO	ANODE	1		
		REC91490-40030	PIN BLOQUEADOR	COTTER PIN	COPPIGLIA	GOUPILLE	1		
		REC68V-W0078-00	KIT BOMBA DE AGUA	WATER PUMP REPAIR KIT	KIT POMPA DELL'ACQUA	KIT POMPE À EAU	1		
			RECKITF115A	CM15026A	ANODO	ANODE	ANODO	ANODE	x 3
				REC5GH-13440-00	FILTRO DE ACEITE	OIL FILTER	FILTRO OLIO	FILTRE À HUILE	1
CM67F-11325-01A	ANODO			ANODE	ANODO	ANODE	x 3		
REC60V-12411-00	TERMOSTATO			THERMOSTAT	TERMOSTATO	THERMOSTAT	1		
NGKLF6A-11	BUJÍA			SPARK PLUG	CANDELE	BOUGIE	x 4		
REC6CB-24501-01	FILTRO COMBUSTIBLE			FUEL FILTER	FILTRO COMBUSTIBILE	FILTRE ESSENCE	1		
REC6CB-13016-00	TÓRICA			O-RING	O-RING	JOINT TORIQUE	1		
REC63P-13915-00	FILTRO COMBUSTIBLE			FUEL FILTER	FILTRO COMBUSTIBILE	FILTRE ESSENCE	1		
REC6CB-14984-00	TÓRICA			O-RING	O-RING	JOINT TORIQUE	1		
CM6G5-45251-01A	ANODO			ANODE	ANODO	ANODE	1		
REC6D8-WS24A-00	FILTRO COMBUSTIBLE			FUEL FILTER	FILTRO COMBUSTIBILE	FILTRE ESSENCE	1		
PAGB/T3452.1-32.5X1.8	TÓRICA			O-RING	O-RING	JOINT TORIQUE	1		
PAF15-04000003	ARANDELA			WHASER	RONDELLA	RONDELLE	1		
REC90430-08020	JUNTA DESAGÜE			DRAIN GASKET	GUARNIZIONE DRENAGGIO	JOINT DE VIDANGE	x 2		
CM6E5-45371-01A	ANODO			ANODE	ANODO	ANODE	1		
REC91490-40030	PIN BLOQUEADOR			COTTER PIN	COPPIGLIA	GOUPILLE	1		
REC68V-W0078-00	KIT BOMBA DE AGUA			WATER PUMP REPAIR KIT	KIT POMPA DELL'ACQUA	KIT POMPE À EAU	1		







	KIT	REF						
	RECKITF115B	PAF4-04070003	ANODO	ANODE	ANODO	ANODE	x 3	
		F115B (2014+)	PAGB/T3452.1-13X2	TÓRICA	O-RING	O-RING	JOINT TORIQUE	x 3
		F130A (2015+)	CM63P-11325-01A	ANODO	ANODE	ANODO	ANODE	1
			REC5GH-13440-00	FILTRO DE ACEITE	OIL FILTER	FILTRO OLIO	FILTRE À HUILE	1
			CM67F-11325-01A	ANODO	ANODE	ANODO	ANODE	1
			NGKLR6E	BUJÍA	SPARK PLUG	CANDELE	BOUGIE	x 4
			REC6CB-13016-00	TÓRICA	O-RING	O-RING	JOINT TORIQUE	1
			REC63P-13915-00	FILTRO COMBUSTIBLE	FUEL FILTER	FILTRO COMBUSTIBILE	FILTRE ESSENCE	1
			REC6CB-14984-00	TÓRICA	O-RING	O-RING	JOINT TORIQUE	1
			REC6D8-WS24A-00	FILTRO COMBUSTIBLE	FUEL FILTER	FILTRO COMBUSTIBILE	FILTRE ESSENCE	1
			PAGB/T3452.1-32.5X1.8	TÓRICA	O-RING	O-RING	JOINT TORIQUE	1
			CM6H1-45251-02A	ANODO	ANODE	ANODO	ANODE	1
			PAF15-04000003	ARANDELA	WHASER	RONDELLA	RONDELLE	1
			REC90430-08020	JUNTA DESAGÜE	DRAIN GASKET	GUARNIZIONE DRENAGGIO	JOINT DE VIDANGE	x 2
			CM6E5-45371-01A	ANODO	ANODE	ANODO	ANODE	1
			REC91490-40030	PIN BLOQUEADOR	COTTER PIN	COPPIGLIA	GOUPILLE	1
			REC68V-W0078-00	KIT BOMBA DE AGUA	WATER PUMP REPAIR KIT	KIT POMPA DELL'ACQUA	KIT POMPE À EAU	1
			RECKITF150RR	CM63P-11325-11A	ANODO	ANODE	ANODO	ANODE
F150A (2003+)	CM63P-11325-01A			ANODO	ANODE	ANODO	ANODE	1
F150B (2012+)	CM67F-11325-01A			ANODO	ANODE	ANODO	ANODE	x 3
F150D (2015+)	NGKLF5A-11			BUJÍA	SPARK PLUG	CANDELE	BOUGIE	x 4
F150F (2015+)	CM68T-11325-00A			ANODO	ANODE	ANODO	ANODE	x 8
REGULAR ROTATION	REC67F-12411-01			TERMOSTATO	THERMOSTAT	TERMOSTATO	THERMOSTAT	1
	REC63P-12414-00			JUNTA	GASKET	GUARNIZIONE	JOINT	1
	REC35-822626Q15			FILTRO DE ACEITE	OIL FILTER	FILTRO OLIO	FILTRE À HUILE	1
	REC63P-14984-00			TÓRICA VST	VST O-RING	O-RING VST	JOINT TORIQUE VST	1
	REC63P-13915-00			FILTRO COMBUSTIBLE	FUEL FILTER	FILTRO COMBUSTIBILE	FILTRE ESSENCE	1
	REC65L-24563-00			FILTRO COMBUSTIBLE	FUEL FILTER	FILTRO COMBUSTIBILE	FILTRE ESSENCE	1
	REC69J-24501-10			FILTRO COMBUSTIBLE	FUEL FILTER	FILTRO COMBUSTIBILE	FILTRE ESSENCE	1
	REC6P3-WS24A-00			FILTRO COMBUSTIBLE	FUEL FILTER	FILTRO COMBUSTIBILE	FILTRE ESSENCE	1
	REC6P3-24564-00			TÓRICA	O-RING	O-RING	JOINT TORIQUE	1
	PAF15-04000003			ARANDELA	WHASER	RONDELLA	RONDELLE	1
	REC90430-08020			JUNTA DESAGÜE	DRAIN GASKET	GUARNIZIONE DRENAGGIO	JOINT DE VIDANGE	x 2
	REC61A-W0078-A1			KIT BOMBA DE AGUA	WATER PUMP REPAIR KIT	KIT POMPA DELL'ACQUA	KIT POMPE À EAU	1
	REC91490-40030			PIN BLOQUEADOR	COTTER PIN	COPPIGLIA	GOUPILLE	1
	CMY150KITA	KIT ÁNODOS	KIT ANODES	KIT ANODI	KIT ANODES	1		
	RECKITF150CR	TEN01165	ANODO	ANODE	ANODO	ANODE	1	
		F150A (2003+)	CM63P-11325-11A	ANODO	ANODE	ANODO	ANODE	x 4
		F150B (2012+)	CM63P-11325-01A	ANODO	ANODE	ANODO	ANODE	1
		F150D (2015+)	CM67F-11325-01A	ANODO	ANODE	ANODO	ANODE	x 3
		F150F (2015+)	NGKLF5A-11	BUJÍA	SPARK PLUG	CANDELE	BOUGIE	x 4
		COUNTER ROTATION	CM68T-11325-00A	ANODO	ANODE	ANODO	ANODE	x 8
			REC67F-12411-01	TERMOSTATO	THERMOSTAT	TERMOSTATO	THERMOSTAT	1
			REC63P-12414-00	JUNTA	GASKET	GUARNIZIONE	JOINT	1
			REC35-822626Q15	FILTRO DE ACEITE	OIL FILTER	FILTRO OLIO	FILTRE À HUILE	1
			REC63P-14984-00	TÓRICA VST	VST O-RING	O-RING VST	JOINT TORIQUE VST	1
			REC63P-13915-00	FILTRO COMBUSTIBLE	FUEL FILTER	FILTRO COMBUSTIBILE	FILTRE ESSENCE	1
			REC65L-24563-00	FILTRO COMBUSTIBLE	FUEL FILTER	FILTRO COMBUSTIBILE	FILTRE ESSENCE	1
			REC69J-24501-10	FILTRO COMBUSTIBLE	FUEL FILTER	FILTRO COMBUSTIBILE	FILTRE ESSENCE	1
			REC6P3-WS24A-00	FILTRO COMBUSTIBLE	FUEL FILTER	FILTRO COMBUSTIBILE	FILTRE ESSENCE	1
			REC6P3-24564-00	TÓRICA	O-RING	O-RING	JOINT TORIQUE	1
			PAF15-04000003	ARANDELA	WHASER	RONDELLA	RONDELLE	1
			REC90430-08020	JUNTA DESAGÜE	DRAIN GASKET	GUARNIZIONE DRENAGGIO	JOINT DE VIDANGE	x 2
			REC61A-W0078-A1	KIT BOMBA DE AGUA	WATER PUMP REPAIR KIT	KIT POMPA DELL'ACQUA	KIT POMPE À EAU	1
	REC91490-40030	PIN BLOQUEADOR	COTTER PIN	COPPIGLIA	GOUPILLE	1		
	CMY150CRKITA	KIT ÁNODOS	KIT ANODES	KIT ANODI	KIT ANODES	1		





	KIT	REF								
	RECKITF150G	F150G (2017+)	CM67F-11325-01A	ANODO	ANODE	ANODO	ANODE	x 3		
		F175A (2014+)	CM15026A	ANODO	ANODE	ANODO	ANODE	x 2		
		F175C (2017+)	CM68T-11325-00A	ANODO	ANODE	ANODO	ANODE	x 2		
		F200F (2013+)	REC6DA-12411-01	TERMOSTATO	THERMOSTAT	TERMOSTATO	THERMOSTAT	1		
		F200G (2013+)	PAF15-04000003	ARANDELA	WHASER	RONDELLA	RONDELLE	1		
			REC35-822626Q15	FILTRO DE ACEITE	OIL FILTER	FILTRO OLIO	FILTRE À HUILE	1		
			REC6CB-24501-01	FILTRO COMBUSTIBLE	FUEL FILTER	FILTRO COMBUSTIBILE	FILTRE ESSENCE	1		
			REC6CB-13016-00	TÓRICA	O-RING	O-RING	JOINT TORIQUE	1		
			REC63P-13915-00	FILTRO COMBUSTIBLE	FUEL FILTER	FILTRO COMBUSTIBILE	FILTRE ESSENCE	1		
			REC6CB-14984-00	TÓRICA	O-RING	O-RING	JOINT TORIQUE	1		
			REC6P3-WS24A-00	FILTRO COMBUSTIBLE	FUEL FILTER	FILTRO COMBUSTIBILE	FILTRE ESSENCE	1		
			REC6P3-24564-00	TÓRICA	O-RING	O-RING	JOINT TORIQUE	1		
			CM6AW-45251-00A	ANODO	ANODE	ANODO	ANODE	1		
			REC90430-08020	JUNTA DESAGÜE	DRAIN GASKET	GUARNIZIONE DRENAGGIO	JOINT DE VIDANGE	x 2		
			CM6J9-45371-01A	ANODO	ANODE	ANODO	ANODE	1		
			NGKLF6A-11	BUJÍA	SPARK PLUG	CANDELE	BOUGIE	x 4		
			REC61A-W0078-A1	KIT BOMBA DE AGUA	WATER PUMP REPAIR KIT	KIT POMPA DELL'ACQUA	KIT POMPE À EAU	1		
	REC91490-40030	PIN BLOQUEADOR	COTTER PIN	COPIGLIA	GOUPILLE	1				
	CM6K1-45371-02A	ANODO	ANODE	ANODO	ANODE	1				
	RECKITF200A	F200A (2002-07)	REC67F-12411-01	TERMOSTATO	THERMOSTAT	TERMOSTATO	THERMOSTAT	x 2		
		F225A (2002-07)	REC35-822626Q15	FILTRO DE ACEITE	OIL FILTER	FILTRO OLIO	FILTRE À HUILE	1		
			CM15026A	ANODO	ANODE	ANODO	ANODE	x 4		
			TEN01156	ANODO	ANODE	ANODO	ANODE	x 2		
			NGKLF5A-11	BUJÍA	SPARK PLUG	CANDELE	BOUGIE	x 6		
			CM67F-11325-01A	ÁNODO	ANODE	ANODO	ANODE	x 4		
			REC65L-24563-00	FILTRO COMBUSTIBLE	FUEL FILTER	FILTRO COMBUSTIBILE	FILTRE ESSENCE	1		
			REC68V-14984-00	TÓRICA VST	VST O-RING	O-RING VST	JOINT TORIQUE VST	1		
			REC68V-13915-00	FILTRO COMBUSTIBLE	FUEL FILTER	FILTRO COMBUSTIBILE	FILTRE ESSENCE	1		
			REC69J-24501-10	FILTRO COMBUSTIBLE	FUEL FILTER	FILTRO COMBUSTIBILE	FILTRE ESSENCE	1		
			REC6P3-WS24A-00	FILTRO COMBUSTIBLE	FUEL FILTER	FILTRO COMBUSTIBILE	FILTRE ESSENCE	1		
			REC6P3-24564-00	TÓRICA	O-RING	O-RING	JOINT TORIQUE	1		
			PAF15-04000003	ARANDELA	WHASER	RONDELLA	RONDELLE	1		
			CMY200250KITA	KIT ÁNODOS	KIT ANODES	KIT ANODI	KIT ANODES	1		
			REC90430-08020	JUNTA DESAGÜE	DRAIN GASKET	GUARNIZIONE DRENAGGIO	JOINT DE VIDANGE	x 2		
			REC91490-40030	PIN BLOQUEADOR	COTTER PIN	COPIGLIA	GOUPILLE	1		
			REC61A-W0078-A1	KIT BOMBA DE AGUA	WATER PUMP REPAIR KIT	KIT POMPA DELL'ACQUA	KIT POMPE À EAU	1		
	RECKITF200C	F200C (2006-12)	CM15026A	ANODO	ANODE	ANODO	ANODE	x 6		
			REC67F-12411-01	TERMOSTATO	THERMOSTAT	TERMOSTATO	THERMOSTAT	x 2		
			REC35-822626Q15	FILTRO DE ACEITE	OIL FILTER	FILTRO OLIO	FILTRE À HUILE	1		
			TEN01156	ANODO	ANODE	ANODO	ANODE	x 2		
			NGKLF6A-11	BUJÍA	SPARK PLUG	CANDELE	BOUGIE	x 6		
			REC63P-13915-00	FILTRO COMBUSTIBLE	FUEL FILTER	FILTRO COMBUSTIBILE	FILTRE ESSENCE	1		
			REC6P2-14984-00	TÓRICA VST	VST O-RING	O-RING VST	JOINT TORIQUE VST	1		
			REC69J-24501-10	FILTRO COMBUSTIBLE	FUEL FILTER	FILTRO COMBUSTIBILE	FILTRE ESSENCE	1		
			REC6P3-WS24A-00	FILTRO COMBUSTIBLE	FUEL FILTER	FILTRO COMBUSTIBILE	FILTRE ESSENCE	1		
			REC6P3-24564-00	TÓRICA	O-RING	O-RING	JOINT TORIQUE	1		
			PAF15-04000003	ARANDELA	WHASER	RONDELLA	RONDELLE	1		
			REC91490-40030	PIN BLOQUEADOR	COTTER PIN	COPIGLIA	GOUPILLE	1		
			REC90430-08020	JUNTA DESAGÜE	DRAIN GASKET	GUARNIZIONE DRENAGGIO	JOINT DE VIDANGE	x 2		
			CMY200250KITA	KIT ÁNODOS	KIT ANODES	KIT ANODI	KIT ANODES	1		
			REC61A-W0078-A1	KIT BOMBA DE AGUA	WATER PUMP REPAIR KIT	KIT POMPA DELL'ACQUA	KIT POMPE À EAU	1		
			RECKITF225B	F225B (2012+)	CM15026A	ANODO	ANODE	ANODO	ANODE	x 7
				F200C (2012+)	REC67F-12411-01	TERMOSTATO	THERMOSTAT	TERMOSTATO	THERMOSTAT	x 2
	REC35-822626Q15			FILTRO DE ACEITE	OIL FILTER	FILTRO OLIO	FILTRE À HUILE	1		
	CM67F-11325-01A			ÁNODO	ANODE	ANODO	ANODE	x 4		
	NGKLF6A-11			BUJÍA	SPARK PLUG	CANDELE	BOUGIE	x 6		
	REC6CB-24501-01			FILTRO COMBUSTIBLE	FUEL FILTER	FILTRO COMBUSTIBILE	FILTRE ESSENCE	1		
	REC6CB-13016-00			TÓRICA	O-RING	O-RING	JOINT TORIQUE	1		
	REC63P-13915-00			FILTRO COMBUSTIBLE	FUEL FILTER	FILTRO COMBUSTIBILE	FILTRE ESSENCE	1		
	REC6P2-14984-00			TÓRICA VST	VST O-RING	O-RING VST	JOINT TORIQUE VST	1		
	REC6P3-WS24A-00			FILTRO COMBUSTIBLE	FUEL FILTER	FILTRO COMBUSTIBILE	FILTRE ESSENCE	1		
	REC6P3-24564-00			TÓRICA	O-RING	O-RING	JOINT TORIQUE	1		
	PAF15-04000003			ARANDELA	WHASER	RONDELLA	RONDELLE	1		
	REC91490-40030			PIN BLOQUEADOR	COTTER PIN	COPIGLIA	GOUPILLE	1		
	REC90430-08020			JUNTA DESAGÜE	DRAIN GASKET	GUARNIZIONE DRENAGGIO	JOINT DE VIDANGE	x 2		
	CMY200250KITA			KIT ÁNODOS	KIT ANODES	KIT ANODI	KIT ANODES	1		
	REC61A-W0078-A1			KIT BOMBA DE AGUA	WATER PUMP REPAIR KIT	KIT POMPA DELL'ACQUA	KIT POMPE À EAU	1		

	KIT	REF								
	RECKITF225C	F225C (2009-15)	CM15026A	ANODO	ANODE	ANODO	ANODE	x 7		
		F250A (2006-13)	REC67F-12411-01	TERMOSTATO	THERMOSTAT	TERMOSTATO	THERMOSTAT	x 2		
			REC35-822626Q15	FILTRO DE ACEITE	OIL FILTER	FILTRO OLIO	FILTRE À HUILE	1		
			CM67F-11325-01A	ANODO	ANODE	ANODO	ANODE	x 4		
			NGKLF6A-11	BUJÍA	SPARK PLUG	CANDELE	BOUGIE	x 6		
			REC6CB-24501-01	FILTRO COMBUSTIBLE	FUEL FILTER	FILTRO COMBUSTIBILE	FILTRE ESSENCE	1		
			REC6CB-13016-00	TÓRICA	O-RING	O-RING	JOINT TORIQUE	1		
			REC63P-13915-00	FILTRO COMBUSTIBLE	FUEL FILTER	FILTRO COMBUSTIBILE	FILTRE ESSENCE	1		
			REC6P2-14984-00	TÓRICA VST	VST O-RING	O-RING VST	JOINT TORIQUE VST	1		
			REC6P3-WS24A-00	FILTRO COMBUSTIBLE	FUEL FILTER	FILTRO COMBUSTIBILE	FILTRE ESSENCE	1		
			REC6P3-24564-00	TÓRICA	O-RING	O-RING	JOINT TORIQUE	1		
			PAF15-04000003	ARANDELA	WHASER	RONDELLA	RONDELLE	1		
			REC91490-40030	PIN BLOQUEADOR	COTTER PIN	COPPIGLIA	GOUPILLE	1		
			REC90430-08020	JUNTA DESAGÜE	DRAIN GASKET	GUARNIZIONE DRENAGGIO	JOINT DE VIDANGE	x 2		
			CMY200250KITA	KIT ÁNODOS	KIT ANODES	KIT ANODI	KIT ANODES	1		
			REC6P2-W0078-00	KIT BOMBA DE AGUA	WATER PUMP REPAIR KIT	KIT POMPA DELL'ACQUA	KIT POMPE À EAU	1		
			RECKITF250D	F225F (2011+)	REC6CE-12411-00	TERMOSTATO	THERMOSTAT	TERMOSTATO	THERMOSTAT	x 2
F225B (2009+)	TEN01177			ANODO	ANODE	ANODO	ANODE	x 4		
F250D (2011+)	CM68T-11325-00A			ANODO	ANODE	ANODO	ANODE	x 2		
F300B (2011+)	TEN01171			ANODO	ANODE	ANODO	ANODE	x 2		
F300C (2018+)	REC6CB-13016-00			TÓRICA	O-RING	O-RING	JOINT TORIQUE	1		
	REC63P-13915-00			FILTRO COMBUSTIBLE	FUEL FILTER	FILTRO COMBUSTIBILE	FILTRE ESSENCE	1		
	REC6CB-14984-00			TÓRICA VST	VST O-RING	O-RING VST	JOINT TORIQUE VST	1		
	REC6P3-24564-00			TÓRICA	O-RING	O-RING	JOINT TORIQUE	1		
	REC6P3-WS24A-00			FILTRO COMBUSTIBLE	FUEL FILTER	FILTRO COMBUSTIBILE	FILTRE ESSENCE	1		
	PAF15-04000003			ARANDELA	WHASER	RONDELLA	RONDELLE	1		
	REC91490-40030			PIN BLOQUEADOR	COTTER PIN	COPPIGLIA	GOUPILLE	1		
	REC90430-08020			JUNTA DESAGÜE	DRAIN GASKET	GUARNIZIONE DRENAGGIO	JOINT DE VIDANGE	x 2		
	CMY200250KITA			KIT ÁNODOS	KIT ANODES	KIT ANODI	KIT ANODES	1		
	REC6CE-W0078-01			KIT BOMBA DE AGUA	WATER PUMP REPAIR KIT	KIT POMPA DELL'ACQUA	KIT POMPE À EAU	1		
	RECKITF300A			F300A (2008-11)	REC6AW-12411-00	TERMOSTATO	THERMOSTAT	TERMOSTATO	THERMOSTAT	x 2
					TEN01177	ANODO	ANODE	ANODO	ANODE	x 8
					REC6CB-13016-00	TÓRICA	O-RING	O-RING	JOINT TORIQUE	1
			NGKLF6A-11	BUJÍA	SPARK PLUG	CANDELE	BOUGIE	x 8		
			TEN01170	ANODO	ANODE	ANODO	ANODE	x 2		
			TEN01173	ANODO	ANODE	ANODO	ANODE	x 10		
			TEN01171	ANODO	ANODE	ANODO	ANODE	x 10		
			REC63P-13915-00	FILTRO COMBUSTIBLE	FUEL FILTER	FILTRO COMBUSTIBILE	FILTRE ESSENCE	1		
			REC6AW-14984-00	TÓRICA VST	O-RING VST	O-RING VST	TORIQUE VST	1		
			REC6P3-WS24A-00	FILTRO COMBUSTIBLE	FUEL FILTER	FILTRO COMBUSTIBILE	FILTRE ESSENCE	1		
			REC6P3-24564-00	TÓRICA	O-RING	O-RING	TORIQUE	1		
			PAF15-04000003	ARANDELA	WHASER	RONDELLA	RONDELLE	1		
			CMY300350XPKITA	KIT ÁNODOS	KIT ANODES	KIT ANODI	KIT ANODES	1		
			REC90430-08020	JUNTA DESAGÜE	DRAIN GASKET	GUARNIZIONE DRENAGGIO	JOINT DE VIDANGE	x 2		
			REC91490-40030	PIN BLOQUEADOR	COTTER PIN	COPPIGLIA	GOUPILLE	1		
			REC6AW-W0078-00	KIT BOMBA DE AGUA	WATER PUMP REPAIR KIT	KIT POMPA DELL'ACQUA	KIT POMPE À EAU	1		
			RECKITF350A	F350A (2008 +)	REC6AW-12411-00	TERMOSTATO	THERMOSTAT	TERMOSTATO	THERMOSTAT	x 2
	CM67F-11325-01A			ANODO	ANODE	ANODO	ANODE	x 10		
	CM63P-11325-01A			ANODO	ANODE	ANODO	ANODE	x 3		
	NGKLF6A-11			BUJÍA	SPARK PLUG	CANDELE	BOUGIE	x 8		
	REC6CB-13016-00			TÓRICA	O-RING	O-RING	JOINT TORIQUE	1		
	TEN01172			ANODO	ANODE	ANODO	ANODE	x 2		
	TEN01177			ANODO	ANODE	ANODO	ANODE	x 8		
	REC6CB-24501-01			FILTRO COMBUSTIBLE	FUEL FILTER	FILTRO COMBUSTIBILE	FILTRE ESSENCE	1		
	REC6CB-13016-00			TÓRICA VST	O-RING VST	O-RING VST	TORIQUE VST	1		
	REC63P-13915-00			FILTRO COMBUSTIBLE	FUEL FILTER	FILTRO COMBUSTIBILE	FILTRE ESSENCE	1		
	REC6CB-14984-00			TÓRICA VST	O-RING VST	O-RING VST	TORIQUE VST	1		
	REC6P3-24564-00			TÓRICA	O-RING	O-RING	TORIQUE	1		
	REC6P3-WS24A-00			FILTRO COMBUSTIBLE	FUEL FILTER	FILTRO COMBUSTIBILE	FILTRE ESSENCE	1		
	CM15026A			ANODO	ANODE	ANODO	ANODE	1		
	CMY300350KITA			KIT ÁNODOS	KIT ANODES	KIT ANODI	KIT D'ANODES	1		
	TEN01170			ANODO	ANODE	ANODO	ANODE	1		
	TEN01175			ANODO	ANODE	ANODO	ANODE	1		
	TEN01174			ANODO	ANODE	ANODO	ANODE	1		
	CM63P-11325-11A			ANODO	ANODE	ANODO	ANODE	1		
	PAF15-04000003			ARANDELA	WHASER	RONDELLA	RONDELLE	1		
	REC90430-08020	JUNTA DESAGÜE	DRAIN GASKET	GUARNIZIONE DRENAGGIO	JOINT DE VIDANGE	x 2				
	REC6AW-W0078-00	KIT BOMBA DE AGUA	WATER PUMP REPAIR KIT	KIT POMPA DELL'ACQUA	KIT POMPE À EAU	1				
	REC91490-40030	PIN BLOQUEADOR	COTTER PIN	COPPIGLIA	GOUPILLE	1				

# SISTEMA DE ALIMENTACIÓN Y FILTRACIÓN FUEL & FILTRATION SYSTEM

## SISTEMA DI ALIMENTAZIONE E FILTRAZIONE SYSTÈME D'ALIMENTATION ET DE FILTRATION

BOMBA DE  
COMBUSTIBLE

FUEL PUMP

POMPA BENZINA

POIRE À  
CARBURANT

BOMBA DE COMBUSTIBLE

FUEL PUMP

POMPA BENZINA



POIRE À CARBURANT

Fabricada con elastómeros termoplásticos inyectados, resistentes al alcohol y rayos UV.s

Premium quality bulb resistance to alcohol as well as UV and ozone.

Fabbricata con elastomero termoplastico, resistente ai solventi e raggi UV.

Fabriqué avec des élastomères thermo-plastiques injectés, résistant à l'alcool et aux rayons UV.

REF		
GS31187	1/4" = 6 mm	1
GS31090	5/16" = 8 mm	1
GS31095	3/8" = 9.5 mm	1



 GOLDENSHIP

LÍNEA DE COMBUSTIBLE

FUEL LINE ASSEMBLY

TUBO CARBURANTE



TUYAU CARBURANT

Universal. Manguera resistente al alcohol.

Universal. Alcohol resistant hose.

Universale. Tubo resistente ai solventi.

Universelle. Tuyau résistant à l'alcool.

REF		
GS31096	5/16" x 2 m	1
GS31097	3/8" x 2 m	1
GS31099	8 mm x 2 m	1
SIE18-8013	5/16" x 2 m	1
SIE18-8015	3/8" x 2 m	1



SIE18-8013  
SIE18-8015

**new**

REF	OEM		
GS31183	6Y1-24360-52-00	6 mm x 2 m	1
	6Y1-24360-52-01		
	6Y1-24360-52-02		
	6Y1-24360-52-51		
	6Y1-24360-52-52		



**new**

REF	OEM		
PAF15-09000000	6G1-24306-55	6 mm x 3m	1
	6Y1-24306-55-00		

MANGUERA DE  
COMBUSTIBLE

FUEL HOSE

TUBO BENZINA





TUYAU CARBURANT

Manguera «Trident» para líneas de combustible. Con refuerzo termoplástico que le permite excelente flexibilidad y resistencia a los rayos UV. Color gris. Resistente al alcohol. Especialmente indicado para motores fueraborda. Garantía: 3 años

Marine fuel hose (distribution and vent) for outboards. Fuel resistant thermo-plastic formulation with 2 spiral reinforcement provides excellent bendability and resistance to UV, aging and permeation by all marine fuels (gasoline/petrol and diesel) including alcohol blends. Warranty: 3 years

Tubo «Trident» per linea combustibile. Con rinforzo termoplastico che gli permette un'eccellente flessibilità e resistenza ai raggi UV. Colore grigio. Resistente ai solventi. Indicato per i motori fuoribordo. Garanzia: 3 anni

Tuyau «Trident» pour carburant. Avec renfort thermoplastique qui permet une excellente flexibilité et résistance aux rayons UV. Gris. Résistant à l'alcool. Convient particulièrement aux moteurs hors-bord. Garantie: 3 ans

REF				
TRI305-0566	5/16" = 7,92 mm	15 m	1	SAE1527
TRI305-0386	3/8" = 9,53 mm	15 m	1	ISO-8469 B1 CE





YAMAHA

RECAMBIOS MARINOS



De goma para diesel y gasolina sin plomo. Ideal para fueraborda. Refuerzos textiles internos. Muy flexible. Contenido aromático 50%

Rubber Hose suitable for loading mineral oils, diesel and unloaded fuel

In gomma per diesel e benzina senza piombo. Ideale per motori fuoribordo. Tessuto interno rinforzato. Molto flessibile.

Caoutchouc pour diesel et essence sans plomb. Idéal pour le hors-bord. Renforts textiles internes. Très flexible

### CARBUPOMP/10NL



REF	Ø (mm)					
GS35031	6x12	10 bar	50 mm	-25°C → 80° C	50 m	ISO R1307
GS35032	8x15	10 bar	65 mm		50 m	

H.T. - CARBUPOMP/10NL - WP 10 BAR - R<1M Ø/m - ISO R1307

### MUELLE TUBO COMBUSTIBLE

### SPRING, FUEL PIPE

### MOLLA TUBO COMBUSTIBILE

### RESSORT, TUYAU DE CARBURANT

new

REF	OEM
PAF4-04000030	90467-08004
PAF4-05000010	90467-13M13



### ABRAZADERA

### CLAMP SMALL

### FASCETTE

### COLLIER

new

REF	OEM	
REC650-24351-51	650-24351-00	6 mm
	650-24351-01	
	650-24351-50	
	650-24351-51	
REC6E5-24351-51	6E5-24351-00	8 mm
	6E5-24351-51	



REF		
REC09401-11425	6-8 mm	1
REC09401-11425BULK	6-8 mm	25



### ADPATADOR LÍNEA DE COMBUSTIBLE

### COUPLER

### ADATTATORE

### RACCORD COUPLEUR

REF	Ø 11 mm --> Ø 9 mm
REC22-8M0001721	



### COMPONENTES TANQUE Y CONECTORES

### FUEL TANK COMPONENTS & CONNECTORS

### COMPONENTI SERBATOIO E CONETTORI

### COMPOSANTS ET CONNECTEURS DU RÉSERVOIR

### TAPÓN CON RESPIRADERO

### PLUG WITH BREATHER

### SPINA CON RESPIRO

### BOUCHON AVEC EVENT

new

REF	OEM
PAF15-10010000	6YJ-24610-01
	6YJ-24610-00



### TAPÓN

### PLUG

### TAPPO

### BOUCHON

new

REF	OEM	
PAF4-04120100	67D-24610-00	F2.5 F4
	67D-24610-02	
	67D-24610-03	
	67D-24610-04	
	68D-24610-10	



### RESORTE DE SEGURIDAD PARA TAPÓN

### SPRING, PREVENT DESQUAMATING

### MOLLA SICURTÀ PER TAPPO

### RESSORT DE SÉCURITÉ POUR LE BOUCHON

new

REF	OEM
PAF4-04120103	624-24634-00

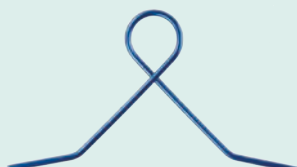



<b>FILTRO</b>	<b>FILTER</b>	<b>FILTRO</b>	<b>FILTRE</b>	<b>new</b>				
<table border="1"> <thead> <tr> <th>REF</th> <th>OEM</th> </tr> </thead> <tbody> <tr> <td>PAF15-1000002</td> <td>6YJ-24167-00</td> </tr> </tbody> </table>		REF	OEM		PAF15-1000002	6YJ-24167-00		
REF	OEM							
PAF15-1000002	6YJ-24167-00							

<b>MEDIDOR DE COMBUSTIBLE</b>	<b>OLEOMETER ASSY</b>	<b>MISURATORE DI CARBURANTE</b>	<b>TUBE D'ASPIRATION POUR RESERVOIR</b>	<b>new</b>							
<table border="1"> <thead> <tr> <th>REF</th> <th>OEM</th> </tr> </thead> <tbody> <tr> <td>PAF15-10020000</td> <td>6YJ-24260-00</td> </tr> <tr> <td>PAF15-10000003</td> <td>6YJ-24260-10</td> </tr> <tr> <td></td> <td>6Y1-24268-00</td> </tr> </tbody> </table>		REF	OEM		PAF15-10020000	6YJ-24260-00	PAF15-10000003	6YJ-24260-10		6Y1-24268-00	
REF	OEM										
PAF15-10020000	6YJ-24260-00										
PAF15-10000003	6YJ-24260-10										
	6Y1-24268-00										
	PAF15-10020000		PAF15-10000003								

<b>LLAVE DE CIERRE DE DEPOSITO</b>	<b>KNOB OIL SWITCH</b>	<b>CHIAVE DE DEPOSITO BLOCCO</b>	<b>COMMUTATEUR D'HUILE AVEC BOUTON</b>	<b>new</b>						
<table border="1"> <thead> <tr> <th>REF</th> <th>OEM</th> <th></th> </tr> </thead> <tbody> <tr> <td>PAF2.6-00000004</td> <td>69M-24575-00</td> <td>F2.5</td> </tr> </tbody> </table>		REF	OEM			PAF2.6-00000004	69M-24575-00	F2.5		
REF	OEM									
PAF2.6-00000004	69M-24575-00	F2.5								

<b>CONECTOR DE DEPOSITO</b>	<b>TANK CONNECTOR</b>	<b>ATTACCO SERBATOIO</b>	<b>RACCORDS DE RESERVOIR</b>						
Fabricado en latón.	Made in machined brass.	Fabbricato in ottone.	Fait en laiton.						
<table border="1"> <thead> <tr> <th>REF</th> <th></th> <th></th> </tr> </thead> <tbody> <tr> <td>GS31068</td> <td>1/4" NPT</td> <td>1</td> </tr> </tbody> </table>		REF			GS31068	1/4" NPT	1		
REF									
GS31068	1/4" NPT	1							



Para conectar dos motores a un sólo depósito, o viceversa. Fabricado en latón.	To connect two motors to a single tank, or vice versa. Made in machined brass	Per collegare due motori a un singolo serbatoio o viceversa. Fabbricato in ottone.	Pour connecter deux moteurs à un même réservoir, ou inversement. Fait en laiton.						
<table border="1"> <thead> <tr> <th>REF</th> <th></th> <th></th> </tr> </thead> <tbody> <tr> <td>GS31069</td> <td>1/4" NPT</td> <td>1</td> </tr> </tbody> </table>		REF			GS31069	1/4" NPT	1		
REF									
GS31069	1/4" NPT	1							



				<b>GOLDENSHIP</b> MADE IN THE USA
<b>REF</b>	<b>OEM</b>			
<b>GS31074</b>	6Y1-24305-05-00	6 mm	1	
	6Y1-24305-06, -00	1/4"		
	6YL-24305-01-00			
	6G1-24305-00, 01, 02			
	6G1-24305-02-00			
<b>GS31075</b>	6G1-24305-03, -00	8 mm	1	
	6G1-24305-04, -00	5/16"		
	6G1-24305-05, -00			
	6G1-24305-0500			
	6Y1-24305-00, -01, -02			
	6Y1-24305-05-00			
<b>GS31076</b>	6Y1-24305-06-00	10 mm	1	
	6YL-24305-01-00	3/8"		
	6E5-24305-05-00			
	6E5-24305-06, -00			
	6Y2-24305-05-00			
	6Y2-24305-06-00			
	6YK-24305-01-00			

new

REF	OEM	
REC6G1-24304-02	6G1-24304-02	6 mm



Conector doble

Double connector

Connettore doppio

Double connecteur

REF		
GS31092	8 mm	1





Toma de tanque de combustible.  
Fabricado en latón.

Fuel tank connector  
Made in machined brass

Filettatura per serbaotio benzina  
Fabbricato in ottone.

Prise de réservoir de carburant.  
Fait en laiton.

REF		
GS31073	1/4" NPT	1
GS31020	1/4" NPT	1

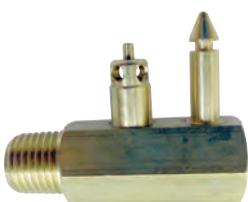

GS31073



GS31020



PASAMAMPAROS

THRU HULL

PASSASCAFO

PASSE-CLOISON

Para atravesar mamparos de hasta 12 mm. Fabricado en latón.

For bulkhead up to 12 mm. Made in machined brass.

Per attraversare paratie fino a 12 mm. Fabbricato in ottone.

Pour traverser des cloisons jusqu'à 12 mm. Fait en laiton.

REF		
GS31064	3/8"	1



FILTRO DE COMBUSTIBLE Y ELEMENTOS

FUEL FILTERS AND ELEMENTS

FILTRI BENZINA E RACCORDI

FILTRE A ESSENCE ET CARTOUCHE DE RECHANGE

BRACKET

BRACKET

SUPPORTO

TÊTE DE FILTRE À ESSENCE

Con 2 tapones de bronce y 2 tubos de extensión. (2 entradas y 2 salidas).

With 2 brass plugs and 2 extension tubes. (2 inputs & 2 outputs).

Con 2 tappi di bronzo e 2 tubi di estensione. (2 ingressi entrata carburante e 2 uscite carburante).

Avec 2 bouchons en bronze et 2 tubes d'extension. (2 entrées et 2 sorties).

REF		
REC25000	1/4"	AL
REC25010	1/4"	INOX /SS AISI316
REC25020	3/8"	AL
REC25030	3/8"	INOX /SS AISI316
RECOBBRACKET	1/4"	Plástico   Plastic Plastica   Plastique



REC25000 - REC25020



REC25010 - REC25030



RECOBBRACKET

FILTRO COMBUSTIBLE SEPARADOR DE AGUA

WATER SEPARATING FUEL FILTER

FILTRO SEPARATORE ACQUA-BENZINA

FILTRE À ESSENCE

REF	MICRON	
REC24942	10	4 <sup>7</sup> / <sub>16</sub> " = 11 cm
REC35-802893Q01	10	3 <sup>3</sup> / <sub>4</sub> "
REC855686	28	4 <sup>7</sup> / <sub>16</sub> "
REC35-802893Q	25	3 <sup>3</sup> / <sub>4</sub> "
RACPF5510	10	4 <sup>7</sup> / <sub>16</sub> "

RACOR

RECMAR



RACPF5510



REC24942



REC35-802893Q01



REC855686



REC35-802893Q

YAMAHA

RECAMBIOS MARINOS

Filtro original.

OEM filter.

Filtro benzina originale.

Filtre à essence original

REF	MICRON	
RM35-802893Q	10	3 3/4"



**FILTRO CON BRACKET**

Con 2 tapones de bronce y 1 tubo de extensión.



**OEM FILTER WITH BRACKET**

With 2 brass plugs & 1 extension tube.

**FILTRO BENZINA CON SUPPORTO**

Con 2 tappi di bronzo e 1 tubo di estensione.

FILTRE A ESSENCE AVEC SUPPORT avec 2 bouchons en bronze et 1 tube d'extension

REF	MICRON			BRACKET
REC24950	25	1/4"	50 GPH	AL
REC24952	10	1/4"	50 GPH	AL





**FILTRO DECANTADOR DE COMBUSTIBLE COMPLETO CON VASO TRASPARENTE**

**COMPLET FUEL FILTER WITH TRANSPARENT BOWL**

**FILTRO DI DECANTAZIONE BENZINA COMPLETO CON VASCHETTA TRASPARENTE**

**FILTRE SÉPARATEUR D'ESSENCE**

REF	OEM		BRACKET
RAC320R-RAC-01	YMM-2W227-01		AL
RAC320R-RAC-03		RACS3213	Plástico Plastic Plastique

REF			BRACKET
RECOFILALU			AL
RECOFILTER	RECOBELEMENT	150 l/h	Plástico Plastic Plastique



REF	OEM		R.O. / OEM	MICRON		
REC90794-46866	907-94469-05	REC90794-46868	907-94469-13	10	117 l/h	175 hp



Ø 8mm

**LLAVE PARA FILTRO  
FILTER KEY  
CHIAVE DA FILTRO  
CLÉ A FILTRE**

REF
RECYS-225-15



REF	R.O./OEM	MICRON	
PAF40-0701000EI	907-94469-05	10	70 hp





Ø 6 mm



new







REF	OEM		OEM	MICRON		
RAC120R-RAC-01	YMM-2W114-00	RACS3240	YMM-2E114-00	10	114 l/h	50 -115 hp

**RACOR**



new

REF	OEM		OEM	MICRON				<b>RACOR</b>
RAC490R-RAC-01	YMM-2W227-01	RACS3227	YMM-2E227-00, 01	10	340 l/h	3/8" NPTF	150 hp	

FILTRO CON BOMBA CEBADORA

FILTER WITH PRIMMING PUMP

FILTRO CON PEMPETA PER RIEMPIRE

FILTRE ESSENCE AVEC POMPE D'AMORCAGE



LLAVES PARA FILTRO	FILTER KEY	CHIAVE DA FILTRO	CLÉ À FILTRE
--------------------	------------	------------------	--------------

REF
RACRK22628

**RACOR**





REF	65 - 110 mm
REC70720	

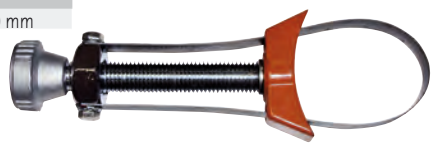

**RECMAR**



RACOR DE LATÓN	RACOR MADE IN BRASS	RACCORDO IN OTTONE	RACCORD EN LAITON
----------------	---------------------	--------------------	-------------------

REF			
GS31065	1/4" NPT	3/8" = 9.5 mm	1
GS31166	1/4" NPT	5/16" = 7.9 mm	2
GS31155	3/8" NPT	3/8" = 9.5 mm	2
GS31156	3/8" NPT	5/16" = 7.9 mm	2
GS31157	3/8" NPT	1/4" = 6.4 mm	2



REF			
GS31066	1/4" NPT	5/16" = 7.9 mm	2
GS31067	1/4" NPT	3/8" = 9.5 mm	2



**GOLDENSHIP**

YAMAHA

RECAMBIOS MARINOS



**FILTRO COMBUSTIBLE PARA MONTAJE EN LINEA**

**IN-LINE FUEL FILTER**

REF				
GS31001	50 l/h	6-8 mm	plástico plastic	1
GS31002	150 l/h	8-10 mm	plástica plastica plastique	1



**GOLDENSHIP**

REF			
GS30435	6, 8, 10 mm	metal + cristal metal + crystal metal + cristal métal + cristal	1



**GOLDENSHIP**

REF	OEM			
REC40145	65W-24251-10	1/4"	1/4"	plástico plastic plastica plastique
REC40155		5/16"	5/16"	
REC40165	67F-24251-02	3/8"	3/8"	
REC40135		5/16"	3/8"	



REF	OEM	
PAF4-04120005	6L5-24251-00	



REF	OEM		
REC35-80365M	646-24251-02		
PAF4-05000300	646-24251-01		



REF	OEM		
REC68T-24251-00	68T-24251-00 68T-24251-01 6EE-F4251-00	F6, F8 (2001+)	



REF	OEM	
REC6F5-24563-00	6F5-24563-00	9.9 hp
REC61N-24563-10	61N-24563-10 61n-24563-00	



REC6F5-24563-00

REC61N-24563-10

**FILTRO BENZINA PER MONTARE IN LINEA**

**FILTRE A ESSENCE EN LIGNE**

REF	OEM	
PAF15-07080000	61N-24560-00	15 - 60 hp



REF	OEM	
PAF15-07080002	61N-24521-00	plástico plastic plastica plastique



REF	OEM
REC64J-24560-10	64J-24560-00 64J-24560-10

- E75, 75AE, AET (2003-15)
- 85 AED, AET (2003-15)
- F40 (2002-07)
- T50, FT50, F50 (2001-16)
- T60, FT60, F60 (2002-07)



REF	OEM
REC6BG-13915-00	6BG-13915-00

- F30 (2013)
- F40 (2008-13)
- F50 (2005-13)
- F60 (2005-13)
- F70 (2010-13)
- F75 (2005-13)
- F90 (2005-13)
- T50 (2005-13)
- T60 (2005-13)



REF	OEM
REC6C5-24251-00	6C5-24251-00

- F30 (2009+)
- F40 (2006+)
- F50 (2005+)
- F60 (2005+)
- F70 (2011+)
- F75 (2005)
- F80 (2008+)
- F100 (2005+)
- F115 (2014+)
- F130 (2015+)



REF	OEM
REC68V-24563-00	68V-24563-00

- EUROPE
- F40
- F50
- F50
- F80
- F100
- F115



REF	OEM
REC6D8-WS24A-00	6D8-WS24A-00 6D8-24563-00

- F50 - F115



REF	OEM
REC68F-24563-10	68F-24563-10



150-300HP (2004-06)  
Z, VZ, LZ

REF	OEM
REC6P2-WS245-00	6P2-WS245-00 6P2-24563-00



F (L) 200C  
F (L) 250A

**new**

REF	OEM
REC6C5-13915-00	6C5-13915-00



F50 (2005-13) F90 (2005-13)  
F60 (2005-13) T50 (2005-13)  
F70 (2010-13) T60 (2005-13)  
F75 (2005-13)

REF	OEM
REC68F-24563-00	68F-24563-00



(L) Z 150P, Q  
(L) Z 175 G  
(L) Z 200N/P  
(L) Z 250 D/F

**new**

REF	OEM
REC69J-24501-10	69J-24501-10



F150-F225 (2006-14)  
F250 (2005-14)

REF	OEM
REC69J-24502-00	69J-24502-00



LF/FL/F150A,T,D,B (2005+)  
LF/FL/F200A,T,B (2004-11)  
LF/FL/F225T,A (2004-11)  
F75T, B (2005)  
F80B,A (2005+)  
F90,T,B,A (2013+)  
F100D (2005+)

**new**

REF	OEM
REC6P3-WS24A-00	6P3-WS24A-00 6P3-WS24A-01 6P3-24563-00



F150 (2007-11) F350 (2008-11)  
Z200 (2007) F250 (2009-11)  
Z150/175 (2007) Z300 (2007)  
F225 (2007-11) F300 (2011)  
F200 (2007-11)

REF	OEM
REC6P3-24564-00	6P3-24564-00



REF	OEM
REC65L-24563-00	65L-24563-00



F200 (2002-06)  
F150 (2004-06)  
225FETO (2003)  
L/250B (1997-2003)

REF	OEM
REC61A-24563-00	61A-24563-00



V6, 3'1L, D-T

**GUÍA FILTROS DE COMBUSTIBLE FUEL FILTER GUIDE GUIDA FILTRO BENZINA GUIDE FILTRE À ESSENCE**

	REF
3A / F2,5A / F4A	PAF4-04120005
4A / 5C / 6C / 8C	PAF4-05000300
F4B / F5A / F6A / F6C / F8C / FT8D / F9,9J / FT9,9L	REC68T-24251-00
F9,9C / FT9,9D / F15A / F25A / FT25B (-2004)	REC40145
F9,9C (1001584+) / FT9,9D (1001139+) / F15A (1009198+) / F25A & FT25B (1013331+) (2004+)	REC61N-24563-10
F25G	REC6D8-WS24A-00
F30A / F40B	REC40145
FT50B (-2000)	REC61N-24563-10
FT50B (2001+)	REC68V-24563-00
F60A / FT60B (-2003)	REC68V-24563-00
F60A / FT60B (2004+)	REC61N-24563-10
F50F / FT50G / F60C / FT60D (-2006)	REC68V-24563-00
F50F / FT50G / F60C / FT60D (2007+)	REC6D8-WS24A-00
F30B / F40F / F50H / F60F / FT50J / FT60G / F70A	REC6D8-WS24A-00
F80A / F100A (-2001)	REC40165
F80A / F100A (2002+)	REC61N-24563-10
F80B / F100D / F(L)115A (-2006)	REC68V-24563-00
F80B / F100D / F(L)115A (2007+) / F(L)115B	REC6D8-WS24A-00
F100F	REC6D8-WS24A-00

	REF
F(L)150A / F(L)200A / F200B / F(L)225A(-2006)	REC65L-24563-00
F(L)150A / F(L)200A / F200B / F(L)225A (2007+)	REC6P3-WS24A-00
F(L)200C / F(L)250A (-2006)	REC6P2-WS245-00
F(L)200C / F(L)250A (2007+)	REC6P3-WS24A-00
F(L)225B / F225C / F(L)225F (V6 4,2L) / F(L)250D (V6 4,2L) / F(L)300A / F(L)300B(V6 4,2L) / F(L)350A / F(L)200F / F(L)200G / F175A	REC6P3-WS24A-00
9,9F / 15F / F15C / F20B / 25N / F25D / FT25F / 30D / 40V / 50G / F50A / 60F / 75C / 90A / 100A / F100B / 115C / (L)130B / (L)150F / 175D / (L)200F / 200G / 225D	REC61N-24563-10
115B	REC6F5-24563-00
(L)250A	REC61A-24563-00
225G / 250B	REC65L-24563-00
(L)Z150P / (L)Z150Q / Z175G / (L)Z200N / Z200P (-2004)	REC68F-24563-00
(L)Z150P / (L)Z150Q / Z175G / (L)Z200N / Z200P (2005-06)	REC68F-24563-10
(L)Z150P / (L)Z150Q / Z175G / (L)Z200N / Z200P (2007+)	REC6P3-WS24A-00
(L)Z250D / Z250F (-2003)	REC68F-24563-00
(L)Z250D / Z250F (2004-06)	REC68F-24563-10
(L)Z250D / Z250F (2007+)	REC6P3-WS24A-00
(L)Z300A (-2006)	REC68F-24563-10
(L)Z300A (2007+)	REC6P3-WS24A-00

FILTRO VST		VST FILTER	FILTRO VST	FILTRE VST																																									
<table border="1"> <thead> <tr> <th>REF</th> <th>OEM</th> </tr> </thead> <tbody> <tr> <td>REC68V-13915-00</td> <td>68V-13915-00</td> </tr> </tbody> </table> 	REF	OEM	REC68V-13915-00	68V-13915-00	<table border="1"> <thead> <tr> <th>REF</th> <th>OEM</th> </tr> </thead> <tbody> <tr> <td>F115 (2000-09)</td> <td></td> </tr> <tr> <td>F200 TXR (2002-09)</td> <td></td> </tr> <tr> <td>LF200 TXR (2002-09)</td> <td></td> </tr> <tr> <td>F225 TXR (2002-09)</td> <td></td> </tr> <tr> <td>F225 TUR (2002-09)</td> <td></td> </tr> </tbody> </table>	REF	OEM	F115 (2000-09)		F200 TXR (2002-09)		LF200 TXR (2002-09)		F225 TXR (2002-09)		F225 TUR (2002-09)		<table border="1"> <thead> <tr> <th>REF</th> <th>OEM</th> </tr> </thead> <tbody> <tr> <td>REC68F-13915-00</td> <td>68F-13915-00</td> </tr> </tbody> </table> 	REF	OEM	REC68F-13915-00	68F-13915-00	<table border="1"> <thead> <tr> <th>REF</th> <th>OEM</th> </tr> </thead> <tbody> <tr> <td>HPDI 150 (2000-05)</td> <td></td> </tr> <tr> <td>V-Max HPDI 150 (2000-09)</td> <td></td> </tr> <tr> <td>HPDI 225 (2003-09)</td> <td></td> </tr> <tr> <td>HPDI 250 (2003-09)</td> <td></td> </tr> <tr> <td>HPDI 300 (2004-09)</td> <td></td> </tr> </tbody> </table>	REF	OEM	HPDI 150 (2000-05)		V-Max HPDI 150 (2000-09)		HPDI 225 (2003-09)		HPDI 250 (2003-09)		HPDI 300 (2004-09)											
REF	OEM																																												
REC68V-13915-00	68V-13915-00																																												
REF	OEM																																												
F115 (2000-09)																																													
F200 TXR (2002-09)																																													
LF200 TXR (2002-09)																																													
F225 TXR (2002-09)																																													
F225 TUR (2002-09)																																													
REF	OEM																																												
REC68F-13915-00	68F-13915-00																																												
REF	OEM																																												
HPDI 150 (2000-05)																																													
V-Max HPDI 150 (2000-09)																																													
HPDI 225 (2003-09)																																													
HPDI 250 (2003-09)																																													
HPDI 300 (2004-09)																																													
<table border="1"> <thead> <tr> <th>REF</th> <th>OEM</th> </tr> </thead> <tbody> <tr> <td>REC66K-13915-00</td> <td>66K-13915-00</td> </tr> </tbody> </table> 	REF	OEM	REC66K-13915-00	66K-13915-00	<table border="1"> <thead> <tr> <th>REF</th> <th>OEM</th> </tr> </thead> <tbody> <tr> <td>HDX150 (1999-05)</td> <td>LX225 (2000-03)</td> </tr> <tr> <td>LX150 (1999-01)</td> <td>S225 (1999)</td> </tr> <tr> <td>PX150 (1999)</td> <td>SX225 (2000-03)</td> </tr> <tr> <td>SX150 (1999-04)</td> <td>V225 (1999)</td> </tr> <tr> <td>VX150 (2000-04)</td> <td>VX225 (2000-04)</td> </tr> <tr> <td>LX200 (1999-01)</td> <td>L250 (1999)</td> </tr> <tr> <td>SX200 (1999-05)</td> <td>LX250 (2000-03)</td> </tr> <tr> <td>V200 (1999)</td> <td>SX250 (2000-03)</td> </tr> <tr> <td>VX200 (2000-05)</td> <td>VX250 (2002-04)</td> </tr> <tr> <td>L225 (1999)</td> <td></td> </tr> </tbody> </table>	REF	OEM	HDX150 (1999-05)	LX225 (2000-03)	LX150 (1999-01)	S225 (1999)	PX150 (1999)	SX225 (2000-03)	SX150 (1999-04)	V225 (1999)	VX150 (2000-04)	VX225 (2000-04)	LX200 (1999-01)	L250 (1999)	SX200 (1999-05)	LX250 (2000-03)	V200 (1999)	SX250 (2000-03)	VX200 (2000-05)	VX250 (2002-04)	L225 (1999)		<table border="1"> <thead> <tr> <th>REF</th> <th>OEM</th> </tr> </thead> <tbody> <tr> <td>REC65L-13915-00</td> <td>665L-13915-00</td> </tr> </tbody> </table> 	REF	OEM	REC65L-13915-00	665L-13915-00	<table border="1"> <thead> <tr> <th>REF</th> <th>OEM</th> </tr> </thead> <tbody> <tr> <td>L225 (1997-98)</td> <td></td> </tr> <tr> <td>S225 (1997-98)</td> <td></td> </tr> <tr> <td>L250 (1997-98)</td> <td></td> </tr> <tr> <td>V200 (1998)</td> <td></td> </tr> <tr> <td>V225 (1998)</td> <td></td> </tr> </tbody> </table>	REF	OEM	L225 (1997-98)		S225 (1997-98)		L250 (1997-98)		V200 (1998)		V225 (1998)	
REF	OEM																																												
REC66K-13915-00	66K-13915-00																																												
REF	OEM																																												
HDX150 (1999-05)	LX225 (2000-03)																																												
LX150 (1999-01)	S225 (1999)																																												
PX150 (1999)	SX225 (2000-03)																																												
SX150 (1999-04)	V225 (1999)																																												
VX150 (2000-04)	VX225 (2000-04)																																												
LX200 (1999-01)	L250 (1999)																																												
SX200 (1999-05)	LX250 (2000-03)																																												
V200 (1999)	SX250 (2000-03)																																												
VX200 (2000-05)	VX250 (2002-04)																																												
L225 (1999)																																													
REF	OEM																																												
REC65L-13915-00	665L-13915-00																																												
REF	OEM																																												
L225 (1997-98)																																													
S225 (1997-98)																																													
L250 (1997-98)																																													
V200 (1998)																																													
V225 (1998)																																													
<table border="1"> <thead> <tr> <th>REF</th> <th>OEM</th> </tr> </thead> <tbody> <tr> <td>REC63P-13915-00</td> <td>63P-13915-00</td> </tr> </tbody> </table> 	REF	OEM	REC63P-13915-00	63P-13915-00	<table border="1"> <thead> <tr> <th>REF</th> <th>OEM</th> </tr> </thead> <tbody> <tr> <td>F150 TXR (2004-09)</td> <td>F300 TXR (2007-09)</td> </tr> <tr> <td>F150 TLR (2004-09)</td> <td>F300 TUR (2007-09)</td> </tr> <tr> <td>F150 TJR (2009)</td> <td>F350 TXR (2007-09)</td> </tr> <tr> <td>LF150 TXR (2004-09)</td> <td>F350 TUR (2007-09)</td> </tr> <tr> <td>F250 TXR (2005-09)</td> <td>F225 TLR (2007-09)</td> </tr> <tr> <td>F250 TUR (2005-09)</td> <td></td> </tr> </tbody> </table>	REF	OEM	F150 TXR (2004-09)	F300 TXR (2007-09)	F150 TLR (2004-09)	F300 TUR (2007-09)	F150 TJR (2009)	F350 TXR (2007-09)	LF150 TXR (2004-09)	F350 TUR (2007-09)	F250 TXR (2005-09)	F225 TLR (2007-09)	F250 TUR (2005-09)		<table border="1"> <thead> <tr> <th>REF</th> <th>OEM</th> </tr> </thead> <tbody> <tr> <td>REC60V-24251-01</td> <td>60V-24251-01</td> </tr> </tbody> </table> 	REF	OEM	REC60V-24251-01	60V-24251-01	<table border="1"> <thead> <tr> <th>REF</th> <th>OEM</th> </tr> </thead> <tbody> <tr> <td>LZ150 (2005)</td> <td>VZ225 (2005-09)</td> </tr> <tr> <td>VZ150 (2005-10)</td> <td>LZ250 (2005)</td> </tr> <tr> <td>Z150 (2005)</td> <td>VZ250 (2005-09)</td> </tr> <tr> <td>VZ175 (2005-10)</td> <td>Z250 (2005)</td> </tr> <tr> <td>Z175 (2005)</td> <td>LZ300 (2005-06)</td> </tr> <tr> <td>LZ200 (2005-10)</td> <td>VZ300 (2005-09)</td> </tr> <tr> <td>VZ200 (2005-09)</td> <td>Z300 (2005-06)</td> </tr> <tr> <td>Z200 (2005-10)</td> <td></td> </tr> </tbody> </table>	REF	OEM	LZ150 (2005)	VZ225 (2005-09)	VZ150 (2005-10)	LZ250 (2005)	Z150 (2005)	VZ250 (2005-09)	VZ175 (2005-10)	Z250 (2005)	Z175 (2005)	LZ300 (2005-06)	LZ200 (2005-10)	VZ300 (2005-09)	VZ200 (2005-09)	Z300 (2005-06)	Z200 (2005-10)			
REF	OEM																																												
REC63P-13915-00	63P-13915-00																																												
REF	OEM																																												
F150 TXR (2004-09)	F300 TXR (2007-09)																																												
F150 TLR (2004-09)	F300 TUR (2007-09)																																												
F150 TJR (2009)	F350 TXR (2007-09)																																												
LF150 TXR (2004-09)	F350 TUR (2007-09)																																												
F250 TXR (2005-09)	F225 TLR (2007-09)																																												
F250 TUR (2005-09)																																													
REF	OEM																																												
REC60V-24251-01	60V-24251-01																																												
REF	OEM																																												
LZ150 (2005)	VZ225 (2005-09)																																												
VZ150 (2005-10)	LZ250 (2005)																																												
Z150 (2005)	VZ250 (2005-09)																																												
VZ175 (2005-10)	Z250 (2005)																																												
Z175 (2005)	LZ300 (2005-06)																																												
LZ200 (2005-10)	VZ300 (2005-09)																																												
VZ200 (2005-09)	Z300 (2005-06)																																												
Z200 (2005-10)																																													

GUÍA FILTROS VST		FUEL FILTER GUIDE	GUIDA FILTRO BENZINA	GUIDE FILTRES VST																																																																																																																				
<table border="1"> <thead> <tr> <th>REF</th> <th>OEM</th> </tr> </thead> <tbody> <tr> <td>PAF4-04120005</td> <td>6L5-24251-00</td> </tr> </tbody> </table>	REF	OEM	PAF4-04120005	6L5-24251-00	<table border="1"> <thead> <tr> <th>REF</th> <th>OEM</th> </tr> </thead> <tbody> <tr> <td>9.9C/D/F</td> <td></td> </tr> <tr> <td>15C/D/F</td> <td></td> </tr> <tr> <td>20/D/F</td> <td></td> </tr> <tr> <td>25B/D/J/N/Q/V</td> <td></td> </tr> <tr> <td>30D/GH</td> <td></td> </tr> <tr> <td>40H/QM/X/Y/F,</td> <td></td> </tr> <tr> <td>40A/B/F</td> <td></td> </tr> <tr> <td>45A/F,</td> <td></td> </tr> <tr> <td>50A/B/FT, 50A,</td> <td></td> </tr> <tr> <td>50D/G/H/PRO,</td> <td></td> </tr> <tr> <td>50</td> <td></td> </tr> <tr> <td>55B</td> <td></td> </tr> <tr> <td>60F</td> <td></td> </tr> <tr> <td>70B</td> <td></td> </tr> <tr> <td>75A/C/PRO</td> <td>REC61N-24563-10</td> </tr> <tr> <td>80A</td> <td>61N-24563-10</td> </tr> <tr> <td>85A</td> <td></td> </tr> <tr> <td>90A</td> <td></td> </tr> <tr> <td>100A/PROV,</td> <td></td> </tr> <tr> <td>100/115B/C(L)</td> <td></td> </tr> <tr> <td>130B/D</td> <td></td> </tr> <tr> <td>150H/ (L), 150C/</td> <td></td> </tr> <tr> <td>(L), 150F</td> <td></td> </tr> <tr> <td>175B/D/(L)</td> <td></td> </tr> <tr> <td>200B/(L),</td> <td></td> </tr> <tr> <td>200F/G/PROV,</td> <td></td> </tr> <tr> <td>200/225B/D</td> <td></td> </tr> <tr> <td>(1994)</td> <td></td> </tr> <tr> <td>FT</td> <td></td> </tr> <tr> <td>9.9D, F9.9C/F</td> <td></td> </tr> <tr> <td>15A/F</td> <td>REC40145</td> </tr> <tr> <td>20A/F</td> <td>65W-24251-00</td> </tr> <tr> <td>25A/FT, 25B/F</td> <td></td> </tr> <tr> <td>30A/F</td> <td></td> </tr> <tr> <td>40B</td> <td></td> </tr> </tbody> </table>	REF	OEM	9.9C/D/F		15C/D/F		20/D/F		25B/D/J/N/Q/V		30D/GH		40H/QM/X/Y/F,		40A/B/F		45A/F,		50A/B/FT, 50A,		50D/G/H/PRO,		50		55B		60F		70B		75A/C/PRO	REC61N-24563-10	80A	61N-24563-10	85A		90A		100A/PROV,		100/115B/C(L)		130B/D		150H/ (L), 150C/		(L), 150F		175B/D/(L)		200B/(L),		200F/G/PROV,		200/225B/D		(1994)		FT		9.9D, F9.9C/F		15A/F	REC40145	20A/F	65W-24251-00	25A/FT, 25B/F		30A/F		40B		<table border="1"> <thead> <tr> <th>REF</th> <th>OEM</th> </tr> </thead> <tbody> <tr> <td>F80A</td> <td>REC40165</td> </tr> <tr> <td>F100A</td> <td>67F-24251-02</td> </tr> <tr> <td>F40C</td> <td></td> </tr> <tr> <td>F50F, FT50C/G/F</td> <td></td> </tr> <tr> <td>60A/C/FT,</td> <td>REC68V-24563-00</td> </tr> <tr> <td>60B/D/F</td> <td>68V-24563-00</td> </tr> <tr> <td>80B/F</td> <td></td> </tr> <tr> <td>100D/F(L)</td> <td></td> </tr> <tr> <td>115A</td> <td></td> </tr> <tr> <td>150A/(L)</td> <td></td> </tr> <tr> <td>225C/(L)</td> <td>REC61A-24563-00</td> </tr> <tr> <td>250A</td> <td>61A-24563-00</td> </tr> <tr> <td>225G/(L)</td> <td></td> </tr> <tr> <td>250B/F(L)</td> <td></td> </tr> <tr> <td>150A/F(L)</td> <td>REC65L-24563-00</td> </tr> <tr> <td>200A/F(L)</td> <td>65L-24563-00</td> </tr> <tr> <td>225A/F(L)</td> <td></td> </tr> <tr> <td>250A</td> <td></td> </tr> <tr> <td>HPDI (Fuel Strainer)</td> <td>REC60V-24251-01</td> </tr> <tr> <td></td> <td>60V-24251-01</td> </tr> </tbody> </table>	REF	OEM	F80A	REC40165	F100A	67F-24251-02	F40C		F50F, FT50C/G/F		60A/C/FT,	REC68V-24563-00	60B/D/F	68V-24563-00	80B/F		100D/F(L)		115A		150A/(L)		225C/(L)	REC61A-24563-00	250A	61A-24563-00	225G/(L)		250B/F(L)		150A/F(L)	REC65L-24563-00	200A/F(L)	65L-24563-00	225A/F(L)		250A		HPDI (Fuel Strainer)	REC60V-24251-01		60V-24251-01
REF	OEM																																																																																																																							
PAF4-04120005	6L5-24251-00																																																																																																																							
REF	OEM																																																																																																																							
9.9C/D/F																																																																																																																								
15C/D/F																																																																																																																								
20/D/F																																																																																																																								
25B/D/J/N/Q/V																																																																																																																								
30D/GH																																																																																																																								
40H/QM/X/Y/F,																																																																																																																								
40A/B/F																																																																																																																								
45A/F,																																																																																																																								
50A/B/FT, 50A,																																																																																																																								
50D/G/H/PRO,																																																																																																																								
50																																																																																																																								
55B																																																																																																																								
60F																																																																																																																								
70B																																																																																																																								
75A/C/PRO	REC61N-24563-10																																																																																																																							
80A	61N-24563-10																																																																																																																							
85A																																																																																																																								
90A																																																																																																																								
100A/PROV,																																																																																																																								
100/115B/C(L)																																																																																																																								
130B/D																																																																																																																								
150H/ (L), 150C/																																																																																																																								
(L), 150F																																																																																																																								
175B/D/(L)																																																																																																																								
200B/(L),																																																																																																																								
200F/G/PROV,																																																																																																																								
200/225B/D																																																																																																																								
(1994)																																																																																																																								
FT																																																																																																																								
9.9D, F9.9C/F																																																																																																																								
15A/F	REC40145																																																																																																																							
20A/F	65W-24251-00																																																																																																																							
25A/FT, 25B/F																																																																																																																								
30A/F																																																																																																																								
40B																																																																																																																								
REF	OEM																																																																																																																							
F80A	REC40165																																																																																																																							
F100A	67F-24251-02																																																																																																																							
F40C																																																																																																																								
F50F, FT50C/G/F																																																																																																																								
60A/C/FT,	REC68V-24563-00																																																																																																																							
60B/D/F	68V-24563-00																																																																																																																							
80B/F																																																																																																																								
100D/F(L)																																																																																																																								
115A																																																																																																																								
150A/(L)																																																																																																																								
225C/(L)	REC61A-24563-00																																																																																																																							
250A	61A-24563-00																																																																																																																							
225G/(L)																																																																																																																								
250B/F(L)																																																																																																																								
150A/F(L)	REC65L-24563-00																																																																																																																							
200A/F(L)	65L-24563-00																																																																																																																							
225A/F(L)																																																																																																																								
250A																																																																																																																								
HPDI (Fuel Strainer)	REC60V-24251-01																																																																																																																							
	60V-24251-01																																																																																																																							

FILTRO DE ACEITE

OIL FILTER

FILTRO OLIO

FILTRE A HUILE

REF	OEM
REC61A-13411-00	61A-13411-00
Z250TR	Z300 AETO
DETO	TXR (2004-07)
FETO (2003-07)	L250G-GETOX (2006-10)
250B	
AETO (1993-06)	
L250B	
TXR (2000-03)	
225G-GETOL (1999-03)	



REF	OEM
REC6E5-13411-00	6E5-13411-00
V-Z 200T	Z1200F-FETO (1996-10)
PETO	225D-DETOX (2000-03)
TLR (2001-07)	115 B
Z150 F	BET (1988-02)
TXRA	130BETO (1991-01)
PETOLX (1996-07)	115CETO
175D	TLR
DETO (1996-03)	TXR (1991-13)



REF	OEM
REC6J8-13411-00	6J8-13411-00
25Q-QEO (1990-94)	FETO
50	L (1989-13)
G-GEO-GETOL (1993-07)	70BETO
50H-HR-MDO (1996-02)	B
40V-MH-MD	BEMO (1989-13)
VETO	25J
VE-O (1995-13)	JEQ
40YETO-YETOL (2005-07)	JETO
30DETOL	NEM
DEOS	W (1988-13)
MH (2011-13)	20D
GOLTRA	EM-ML
F	



REF	OEM
REC68F-13440-00	68F-13440-00
LZ	TLR (2001-07)
LZ300	Z250
TR	TXR
AETO-X-V (2004-07)	DETO
Z175TR	X (2003-07)
GETO-X (2002-07)	Z150P
V	TXR
Z200T	PETO (2000-07)
PETO	



REF	OEM
REC35-80365M	646-24251-02
L150	115
L200	130
225	
175	
250	



REF	OEM
REC6G8-13440-00	6G8-13440-00



REF	OEM
REC5GH-13440-60	5GH-13440-60 5GH-13440-50



**new**

REF	OEM	
REC35-822626Q15	69J-13440-00, 01, 03	3/4" x 16NPT
REC5GH-13440-00	5GH-13440-00, 30, 70	20 x 1.5
REC26-13440-00	N26-13440-00, 02	3/4" x 16 NPT
REC3FV-13440-00	3FV-13440-00, 10, 20, 30	20 x 1.5



GUÍA FILTROS DE ACEITE OIL FILTER GUIDE GUIDA FILTRO OLIO GUIDE FILTRE A HUILE

	REF
F8A	
F9,9A/B	
FT9,9A (1990+)	
F9,9C (2000+)	
FT9,9D (2000+)	
F15A (2000+)	
F20A(2000+)	
F25A (2000+)/FT25B	
F30A	
F40A (2000+)/F40B (2001+)	
F50A(1999-05)/F50F(-2005)/FT50B (2000+)/FT50C (-2005)/FT50G (-2005)	
F60A (-2005)/F60C(-2005)/FT60B (-2005)/FT60D (-2005)	
F80A (2000+)/F80B	
F100A (2000+)/F100B/F100D	
F(L)115A/F115B/F100F	
F15C (2007+)	
F20B (2007+)	
F25D/G FT25F	
F30B	
F40F	
F50A, FT50C, F50F, FT50G, (2006+)	
FT60B, F60A, F60C, FT60D (2006+)	
F50H/F60F/FT50J/FT60G	
F70A/VX	
CRUISER/DELUXE (2008-11)	
VX SPORT 08/FX HO/FX HO CRUISER 08	
F9,9C (1998), FT9,9D (1999), F15A (1998), F20A (1998), F25A (1998-99), F40A (1999), F40B (2000), F50A (1995-98), FT50B (1996-99), F80A, F100A (1999)	
F(L)150A/F175A/F(L)200A/F(L)200C/F(L)200F/F(L)200G/F(L)225A/F(L)225B/F225C/F(L)250A/F(L)250B/FX SHO/FX SHO CRUISER/FX HO CRUISER/FZR/FZS	
F(L)300A/F(L)350A/F(L)225F/F(L)250D/F(L)300B	
	REC6G8-13440-00
	REC5GH-13440-60
	REC3FV-13440-00
	REC35-822626Q15
	REC26-13440-00
<b>WaveRunner Model Part Number Price</b>	
FX140/FX140 CRUISER/FX160/FX160	
CRUISER/FX-H.O CRUISER/FX-HIGH OUTPUT/VX 1100SPORT & DELUXE	REC5GH-13440-00

YAMAHA

RECAMBIOS MARINOS



## BOMBA DE INYECCION DE ACEITE

## OIL INJECTION PUMP

## POMPA INIEZIONE BENZINA

## POMPE D'INJECTION D'HUILE

**new**

REF	OEM
REC6R4-13200-02	6R4-13200-00 6R4-13200-01 6R4-13200-02

150 - 200 HP  
V6  
2T/Strokes



**new**

REF	OEM
REC6E5-81900-01	6E5-81900-01

2T/Strokes

Instalada en el depósito  
Installed in the tank  
Installato nel serbatoio  
Installé dans le réservoir





## ACEITE

## OIL



## OLIO

## HUILES

REF	OEM			
REC2TU6	YMD-63021-01	1 L	6	2 STROKES
REC2TU3	YMD-63021-04	5 L	3	TC-W3
REC5W40U6		1 L	6	SAE 5W40
REC5W40U3		5 L	3	
REC10W30U6	YMD-63050-01	1 L	6	SAE 10W30
REC10W30U3	YMD-63050-04	5 L	3	
REC10W40U6	YMD-63060-01	1 L	6	SAE 10W40
REC10W40U3	YMD-63060-04	5 L	3	
REC25W40U3		5 L	3	SAE 25W40





REF	OEM			
RM92-858026QB1U6	92-858026QB1	1 L	6	2 STROKES
RM92-858027QB1U3	92-858027QB1	3,8 L	3	
RM92-8M0086220U6	92-8M0086220	1 L	6	SAE 10W30
RM92-8M0086221U3	92-8M0086221	4 L	3	



# BOMBA DE COMBUSTIBLE

# FUEL PUMP

# POMPA BENZINA

# POMPE À ESSENCE

## BOMBA DE COMBUSTIBLE MECÁNICA

## FUEL PUMP MECHANICAL

## POMPA BENZINA MECCANICA

## POMPE À ESSENCE MECANIQUE

REF	OEM	2T STROKES	4T STROKES
PAF20-05050000	6AH-24410-00		✓

new

- F9.9H (2009+)
- F13.5B (2007-09)
- F15C,E,M (2007+)
- F20B,E,M (2007+)

REF	OEM	2T STROKES	4T STROKES
REC68V-24410-00	68V-24410-00		✓

new

- F100B (2003-10)
- F100C (2001-07)
- F90 (2003-04)
- F75A, T (2003-04)
- F100A (2003-06)
- F80A (2002-07)
- F115A, TR, J (2000-10)

REF	OEM	2T STROKES	4T STROKES
REC6E5-24410-03	6E5-24410-01-00		✓

- V4
- V6 (1989-03)

REF	OEM	2T STROKES	4T STROKES
PAF15-07140000	66M-24410-11		✓

- F9.9/13.5/15

REF	OEM	2T STROKES	4T STROKES
REC68T-24410-00-00	68T-24410-00 68T-24410-01		✓

- F6A/B/M (2000-09)
- F8C/M/E/D/PF/G (2000+)
- F9.9F/M/E/G/J/L (2008+)

REF	OEM	2T STROKES	4T STROKES
PAF25-05130000	62Y-24410-04		✓

- F20/25//30/40/45/50/60

REF	OEM	2T STROKES	4T STROKES
PAF4-04090000	67D-24410-03		✓

- F4

REF	OEM	2T STROKES	4T STROKES
REC692-24410-00	692-24410-00 6A0-24410-00 6A0-24410-05 6A0-24410-03 6A0-24410-04		✓

- 25-85HP

REF	OEM	2T STROKES	4T STROKES
REC6A0-24410-04	6A0-24410-00 6A0-24410-01 6A0-24410-02 6A0-24410-03 6A0-24410-04		✓

- 20 - 90 HP (1985-92)

REF	OEM	2T STROKES	4T STROKES
REC6C5-24410-00	6C5-24410-00		✓

- F30B (2009+)
- F40A/D/H/F (2006+)
- F50F/T/H/J/G (2005+)
- F60A/B/C/D/F/G/T (2005+)

YAMAHA

RECAMBIOS MARINOS

**BOMBA DE COMBUSTIBLE ELECTRICA**

**FUEL PUMP ELECTRIC**

REF	OEM		2T STROKES	4T STROKES
REC68F-13907-01	68F-13907-01	REC66K-14984-00	✓	



  
 VZ, Z150 (2000-07)  
 VZ, Z175 (2001-07)  
 V, L, Z200 (2000-07)

REF	OEM		2T STROKES	4T STROKES
REC63P-13907-03	63P-13907-03 63P-13907-02 63P-13907-01 63P-13907-00	REC63P-14984-00		✓



  
 F150 A/AET/AETU/AETX/AET1/AET2/BET/BETX/DET/DET/DETX  
 F150 TRC/TXRC/TLRC/TR/TLRD/TLR/TLRF/TRG/TXR/TRF (2004+)

REF	OEM		2T STROKES	4T STROKES
REC69J-13907-03	69J-13907-03 69J-13907-02 69J-13907-01 69J-13907-00 69J-13907-04	REC68V-14984-00		✓

  
 F200 A/AETX/AETU  
 F200 TXRA/TXRB/TXRC/TXRD/TR/TXR/TXRF  
 F225 A/AETU/AETX/AET/TXRA/TXRB/TXRC/TXRD/TXRF  
 F225 TXR/TR/TURD/TURC (2002-10)

REF	OEM		2T STROKES	4T STROKES
REC69J-24410-02	69J-24410-02 69J-24410-01 69J-24410-00	REC6P2-14984-00		✓



  
 F200 A/AETX/AET/CETX  
 F200 TXRA/TXRB/TXRC/TXRD/TR/TXR/TXRF  
 F225 A/AETU/AETX/AET/B/BETU/BETX/CET/CETL  
 F225 TXRA/TXRB/TXRC/TXRD/TXR/TXRF/TR/TURD/TURC  
 F250 AET/AETX/AETU/A/BET/BETX/BETU  
 F250 TXR/TURF/TXRF (2002-11)

REF	OEM		2T STROKES	4T STROKES
REC6AW-13907-00	6AW-13907-00 6P2-13907-00	REC6AW-14984-00		✓



  
 F200 C/ CETX (2006-11)  
 F225 B /BETX/CET/CETL (2006-11)  
 F225 BETU/BETX/A/AETU/AETX/TURF/TRG/TXRF (2006-11)  
 F250 A/B/T (2006-11)  
 F350 AET/AETU/AETX/TRG/TURG (2008-11)

**POMPA BENZINA ELETTRICA**

**POMPE À ESSENCE ELECTRIQUE**

REF	OEM		2T STROKES	4T STROKES
REC66K-13907-00	66K-13907-00 65L-13907-00	REC66K-14984-00	✓	



  
 225G (1999-02)  
 250BETO (1997-02)  
 L/SX250 TXR (2000-02)  
 225FETO/FETOX (2003)

REF	OEM		2T STROKES	4T STROKES
REC67H-13907-00	67H-13907-00	REC66K-14984-00	✓	



  
 225G/GETOL/FETO (2002-04)  
 250B/BETO/TXRA (2002-04)

REF	OEM		2T STROKES	4T STROKES
REC60V-13907-00	60V-13907-00	REC66K-14984-00	✓	

  
 Z, LZ 250 (2003-07)  
 Z, LZ 300 (2003-07)

REF	OEM		2T STROKES	4T STROKES
REC68V-13907-00	68V-13907-00 68V-13907-01 68V-13907-02 68V-13907-03 68V-13907-04	REC68V-14984-00	✓	✓

  
 Z, LZ 250DET/TR/FET (2003-07)  
 Z, LZ 300AET/TR/TX (2004-07)  
 LF/FL/F115A,T (2000-06)

REF	OEM		2T STROKES	4T STROKES
REC866169T01	6C5-13907-00	REC6C5-14984-00	✓	

  
 F40D/G/H (2006+)  
 T/FT/F50F/H/T (2005+)  
 T/FT/F60A/B/C/F/T (2005+)  
 F70A (2011+)  
 F75C/T (2005-09)  
 F80A/B/C (2005+)  
 F90A/B/T (2005+)  
 F100D (2005+)

new



## MEMBRANAS Y JUNTAS

## DIAPHRAGMS &amp; GASKETS

## MEMBRANA E GUARNIZIONI

## MEMBRANES ET JOINTS

REF	OEM
REC6G1-24411-00	6G1-24411-00

3-15HP



REF	OEM
PAF25-05130005	62Y-24471-00

F25>F80HP



REF	OEM
REC6E0-24411-00	6E0-24411-00

4C/5C/AC



REF	OEM
REC663-24411-00	663-24411-00

25>90HP



REF	OEM
REC6E0-24471-00	6E0-24471-00

4HP



REF	OEM
REC6J8-24471-00	6J8-24471-00

30HP



REF	OEM
REC6G1-24471-00	6G1-24471-00

6-8HP



REF	OEM
REC6E5-24411-00	6E5-24411-00-00

115/150/175/200HP



REF	OEM
REC677-24471-01	677-24471-01

E8D/9.9D/15D



REF	OEM
REC6E5-24471-00	6E5-24471-00

115>250HP



REF	OEM
REC63V-24411-00	63V-24411-00

9.9  
13.5  
15HP



REF	OEM
REC6G1-24431-01	6G1-24431-01

3A/MSH  
6C/CEM/D/DEM/TRV/MSH/CMH  
8C/CEM/TRV/MSH/CMH/MH  
9.9F  
13.5AWH  
15F

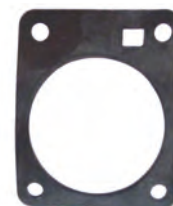

REF	OEM
REC677-24411-02	677-24411-02

9.9>15HP



REF	OEM
REC6E0-24434-00	6G1-24431-01

4AC/MSH/AS/A  
5C/CS/CMH



REF	OEM
REC648-24411-00	648-24411-00

20>70HP



REF	OEM
REC6E0-24435-00	6E0-24435-00

4AC/MSH/AS/A  
5C/CS/CMH



REF	OEM
REC692-24411-00	692-24411-00

20>90HP





REF	OEM
REC677-24435-01	677-24435-01

9.9D  
15D

20DM/DEO  
25NE/NEMO





REF	OEM
REC648-24434-01	648-24434-01
 20C/CM 25Q/D/B/BMH 25V/VE E30HMH 30G/H 40V/VM/VE/YE C40 E40 E40X 40X 50G/GEO/GETO/H/D	55B/BE 60FEO/FETO/TLR E60H 70B/BETO 75CETO/AE E75B 80A/AE 85A/AE 90A/AEO/AET





REF	OEM
REC648-24435-02	648-24435-02
 20C/CM 25Q/D/B/BMH 25V/VE E30HMH 30G/H 40V/VM/VE/YE C40 E40 E40X 40X 50G/GEO/GETO/H/D	55B/BE 60FEO/FETO/TLR E60H 70B/BETO 75CETO/AE E75B 80A/AE 85A/AE 90A/AEO/AET





REF	OEM
REC650-24431-A0	650-24431-A0
 25-300HP	



REF	OEM
REC6E5-24435-00	6E5-24435-00
 100A/TLR 115A/ETN/BET/B/BICET/ TLR 130BETO 140AETO 150AETO/ETN/FETO 175AETO/DETO/BETO 200AETO/ETN	V200/G/BETO 220AET 225DET/BETO 250AET Z300



REF	OEM
REC6E5-24434-02	6E5-24434-02
 100A/TLR 115A/ETN/BET/B/BICET/ TLR 130BETO 140AETO 150AETO/ETN/FETO 175AETO/DETO/BETO 200AETO/ETN	V200/G/BETO 220AET 225DET/BETO 250AET Z300





JUNTAS VST      VST GASKETS      GUARNIZIONE VST      JOINTS VST

REF	OEM
REC68V-14984-00	68V-14984-00
 Z, LZ 250DET/TR/FET (2003-07) Z, LZ 300AET/TR/TX (2004-07) LF/FL/F115A,T (2000-06)	





**new**

REF	OEM
REC6CB-14984-00	6CB-14984-00
 F115 + (2012+) NEW MODEL	





**new**

REF	OEM
REC63P-14984-00	63P-14984-00
 F150 A/AET/AETL/AETX/AET1/AET2/BET/BETX/DET/DET/DETX F150 TRC/TXRC/TLRC/TR/TLRD/TLR/TLRF/TRG/TXR/TRF (2004+)	





**new**

REF	OEM
REC6C5-14984-00	6C5-14984-00
 F40D/G/H (2006+) T/FT/F50F/H/T (2005+) T/FT/F60A/B/C/F/T (2005+) F70A (2011+) F75C/T (2005-09) F80A/B/C (2005+) F90A/B/T (2005+) F100D (2005+)	



**new**

REF	OEM
REC66K-14984-00	66K-14984-00
 Z, LZ 250 (2003-07) Z, LZ 300 (2003-07)	



**new**

REF	OEM
REC6AW-14984-00	6AW-14984-00
 F200 C/ CETX (2006-11) F225 B /BETX/CET/CETL (2006-11) F225 BETU/BETX/A/AETU/AETX/TURF/TRG/ TXRF (2006-11) F350 AET/AETU/AETX/TRG/TURG (2008-11)	

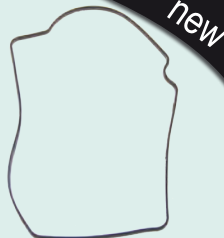

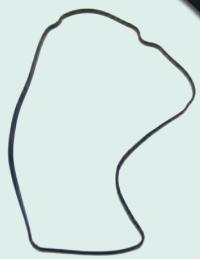

**new**

REF	OEM
REC6P2-14984-00	62P-14984-00
 F200 A/AETX/AET/CETX F200 TXRA/TXRB/TXRC/TXRD/TR/TXR/TXRF F225 A/AETU/AETX/AET/B/BETU/BETX/CET/CETL F225 TXRA/TXRB/TXRC/TXRD/TXR/TXRF/TR/ TURD/TURC F250 AET/AETX/AETU/A/BET/ BETX/BETU F250 TXR/TURF/TXRF (2002-11)	



**new**

REF	OEM
REC6CB-13016-00	6CB-13016-00
 F115 +	



**new**

**REGULADORES DE PRESION COMBUSTIBLE**

**FUEL REGULATOR**

**REGOLATORE BENZINA**

**REGULATEUR DE PRESSION D'ESSENCE**

REF	OEM
REC63P-13906-00	63P-13906-00

F150 (2004+)  
63P/64P/6BM/6BN



*new*

REF	OEM
REC6P2-13906-00	6P2-13906-00

F200 (2006-11)  
6AL / 6AM  
F225 (2007-11)  
6AS/6AT/6BB  
F250 (2006-11)  
6BR/ 6BS/6P



*new*

REF	OEM
REC69J-13906-00	69J-13906-00

F200 (2002-07)  
60L / 60M  
F225 (2005-07)  
69J / 69K



*new*

**INYECTORES**

**INJEKTOR**

**INIETTORE**

**INJECTEURS**

**INJECTOR**

**INJEKTOR**

**INIETTORE**

**INJECTEUR**

REF	OEM
REC6L5-13761-00	65L-13761-00



*new*

REF	OEM
REC6D8-13761-00	6D8-13761-00



*new*

REF	OEM
REC6BG-13761-00	6BG-13761-00



*new*

REF	OEM
REC68V-8A360-00	68V-8A360-00 68V-13761-00



*new*

REF	OEM
REC6C5-13761-00	6C5-13761-00



*new*

REF	OEM
REC6P2-13761-00	6P2-13761-00



*new*



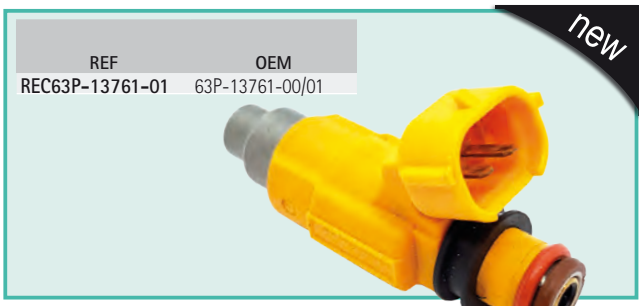

REF	OEM
REC63P-13761-01	63P-13761-00/01

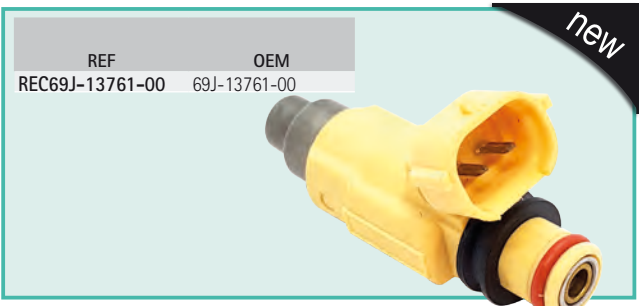

REF	OEM
REC69J-13761-00	69J-13761-00



REF
STA93008 STA93016



REF
GE22207

GUÍA INYECTORES Y SENSORES		GUIDE INJECTORS & SENDERS		GUIDA INIETTORI E SENSORI		GUIDE INJECTEURS ET SONDÉS	
						TPS	MAP
F20 F/G	6GX & 6HY	2017+	REC6FM-13761-00				
F25 G/M	6FM	2017+	REC6FM-13761-00				
F30B	6BT	2009+	REC6BG-13761-00				
F40 A/F	6BG	2009	REC6BG-13761-00				
F40 D/H/G	6AK & 6CY	2006+	REC6C5-13761-00			REC6C5-85885-00	REC68F-83688-00
F50 F/T/H/G/J	6C1 & 6C2	2005+	REC6C5-13761-00			REC6C5-85885-00	REC68F-83688-00
T50 A/B/T	6C2	2005+	REC6C5-13761-00			REC6C5-85885-00	REC68F-83688-00
F60 A/B/C/D/E/F/G/T	6C5 & 6C6	2005+	REC6C5-13761-00			REC6C5-85885-00	REC68F-83688-00
T60 A/B/T	6C6	2005+	REC6C5-13761-00			REC6C5-85885-00	REC68F-83688-00
F70 A	6CJ	2011+	REC6C5-13761-00			REC6C5-85885-00	REC68F-83688-00
F75 T/B	6D61	2005	REC6D8-13761-00			REC6C5-85885-00	REC68F-83688-00
F80 C	6CK	2009-12	REC6D8-13761-00			REC6C5-85885-00	REC68F-83688-00
F80 B	6D7	2005+	REC6D8-13761-00			REC6C5-85885-00	REC68F-83688-00
F100 D	6D9	2005+	REC6D8-13761-00			REC6C5-85885-00	REC68F-83688-00
F115 A/T	68V & 68W	2000-11	REC68V-8A360-00			REC68V-85885-00	REC68V-82380-00
F115A	68V & 68W	2012-15	REC68V-13761-10			REC68V-85885-00	REC68F-83688-10
F115 B	6EK & 6EL	2014+	REC6EK-13761-00			REC6C5-85885-00	REC68F-83688-10
F130 A	6EM	2015+	REC6EK-13761-00				REC68F-83688-10
F150 A/B/C/D/T	63P & 64P	2004-05	REC63P-13761-01	REC63P-13906-00		REC69J-85885-00	REC63P-82380-00
F150 A/T/B/D	63P & 64P	2005+	REC63P-13761-01	REC63P-13906-00		REC6S1-85885-00	REC63P-82380-00
F150 B/F	6BM & 6BN	2012+	REC63P-13761-01	REC63P-13906-00		REC6S1-85885-00	REC63P-82380-00
F150 C/G	6HP & 6HR	2017+	REC6DA-13761-00				REC68F-83688-10
F175 A/C	6FA,6HS,6HT	2014+	REC6DA-13761-00				REC68F-83688-10
F200 A/T	60L & 60M	2000-05	REC69J-13761-00	REC69J-13906-00		REC69J-85885-00	REC68V-82380-00
F200 A/T	60L & 60M	2006-07	REC69J-13761-00	REC69J-13906-00		REC6S1-85885-00	REC68V-82380-00
F200 C	6AL & 6AM	2006	REC6P2-13761-00	REC6P2-13906-00			
F200 A/B/C	6AL,6AM,6S19,6S29	20012+	REC6P2-13761-11	REC6P2-13906-00			
F200 B/F	6DA,6DB,6DV,6DW	2013+	REC6DA-13761-00				REC68F-83688-10
F225 A/T	69J & 69K	2000-07	REC69J-13761-00	REC69J-13906-00		REC69J-85885-00	REC68V-82380-00
F225 A/B/C	6AS,6BB & 6AT	2012-15	REC6P2-13761-11	REC6P2-13906-00			
F250 A/T	6P2 & 6P3	2006-11	REC6P2-13761-00	REC6P2-13906-00			
F250 A/T	6P2 & 6P3	2012-13	REC6P2-13761-11	REC6P2-13906-00			
225G/F	250B	1999-03	REC6L5-13761-00				

CARBURADOR

CARBURATOR

CARBURATORE

CARBURATEUR

CARBURADOR COMPLETO FULL CARBURATOR

CARBURATORE COMPLETO CARBURATEUR COMPLET

REF	OEM
REC6F6-14301-06	6F6-14301-06
 E40G (2008+)	

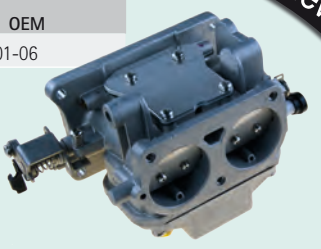



*new*

REF	OEM
REC6B4-14301-00	6B4-14301-00
 E15D (2003+)	



*new*

REF	OEM
PAF2.6-04000200	69M-14301-21
 F2.5 ALL (2003+)	



REF	OEM
PAF4-04140000	67D-14301-03
 F4 (1998-05)	



REF	OEM
REC6G1-14301-01	6G1-14301-01

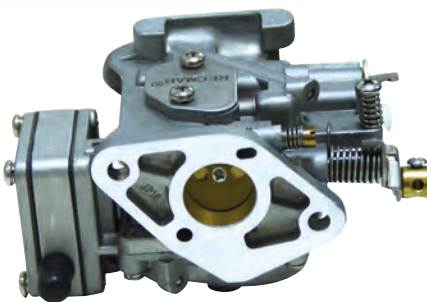

REF	OEM
PAF25-05070000	65W-14901-12
 F25 ALL (1999-06)	

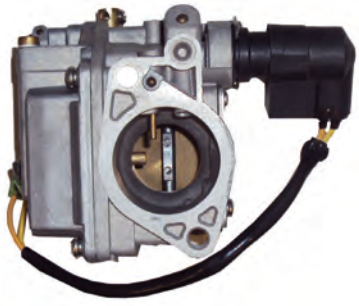



REF	OEM
REC61N-14301-04	61N-14301-04



REF	OEM
REC6L5-14301-03	6L5-14301-03



REF	OEM	
PAF15-07090000	66M-14301-00	Arranque manual Manual starter Messa in moto manuale Démarrage manuell
PAF15-07090000W	66M-14301-00	Arranque eléctrico Electric starter Messa in moto elettrica Démarrage électrique
 F9.9, F13.5, F15 (1998-07)		





PAF15-07090000W

REF	OEM
REC6E3-14301-05	6E3-14301-05





REF	OEM
REC66T-14301-60	66T-14301-60

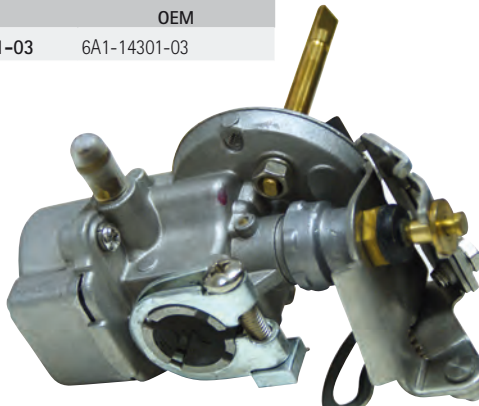

REF	OEM
REC6A1-14301-03	6A1-14301-03

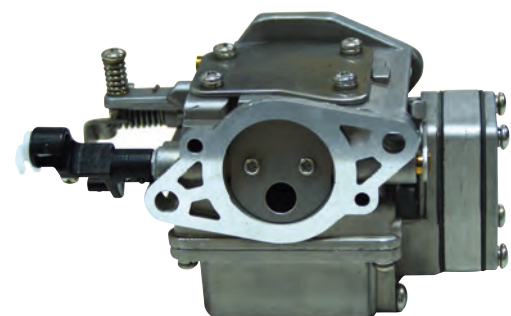

REF	OEM
REC63V-14301-00	63V-14301-00
REC63W-13610-00	

P 99

KIT 3 CARBURADORES

KIT 3 CARBURETORS

KIT 3 CARBURATORI

KIT DE 3 CARBURATEURS

REF	OEM
REC6K5-14301-03	6K5-14301-03 + 6K5-14302-03 + 6K5-14303-03

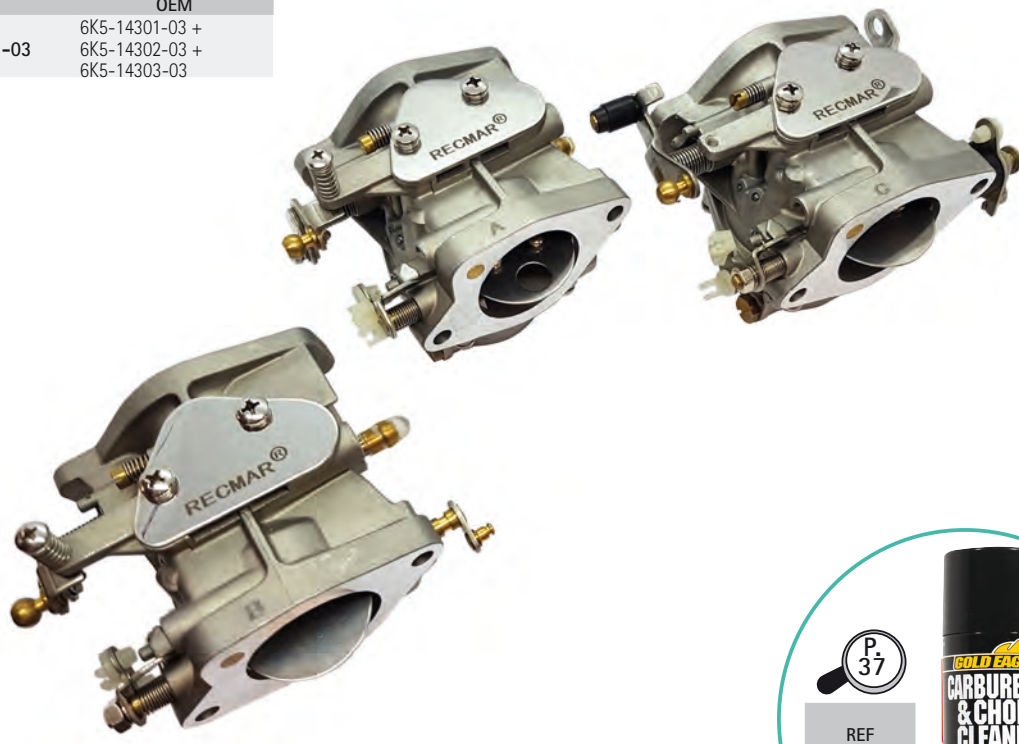



P 37

REF
GEGC15



**GOLD EAGLE**  
**CARBURETOR & CHOKE CLEANER**  
GARRANTY  
To Clean Any Carburetor or Choke



				CARB		KIT			
2B, BMHS, MSHA, MSHB, MSHC, MSHD	6A1-6A14	1985-05	REC6A1-14301-03	REC6A1-W0093-01					
3A, AMHL, MSH	6L5	1988-99	REC6L5-14301-03	REC6G1-W0093-00	REC6G1-14985-00	REC6G1-14546-00			
3A, AMHS, AMHL, AMH, MSHA, MSHB	6L50-6L59	2001-10	REC6L5-14301-03	REC6G1-W0093-00	REC6G1-14985-00	REC6G1-14546-00			
AMH, AMHS	6L5A-6L5F	2011-15	REC6L5-14301-03	REC6G1-W0093-00	REC6G1-14985-00	REC6G1-14546-00			
4AS	-6,00E+001	1994-95	REC6E3-14301-05		REC6E7-14385-00				
4AC	-6,00E+000	1994-98	REC6E3-14301-05		REC6E7-14385-00				
4CMHS, CMHL	6GP1	2016	REC6E3-14301-05		REC6E7-14385-00				
5C	-6,00E+003	1986-99	REC6E3-14301-05		REC6E7-14385-00				
5CS	-6,00E+004	1987-95	REC6E3-14301-05		REC6E7-14385-00				
5CMH	6M0	1994	REC6E3-14301-05		REC6E7-14385-00				
5C, CMHS, CMHL	6E30-6E39	2001-10	REC6E3-14301-05		REC6E7-14385-00				
5CMH, CMHS, CMHL	6E3A-6E3F	2011-15	REC6E3-14301-05		REC6E7-14385-00				
6C, CEM	6H6	1984-96	REC6G1-14301-01	REC6G1-W0093-00	REC6G1-14985-00	REC6G1-14546-00			
6D, DEM	6H8	1984-96	REC6G1-14301-01	REC6G1-W0093-00	REC6G1-14985-00	REC6G1-14546-00			
6J	6H6	1986	REC6G1-14301-01	REC6G1-W0093-00	REC6G1-14985-00	REC6G1-14546-00			
6C, MSH, TRV	6M8	1997-98	REC6G1-14301-01	REC6G1-W0093-00	REC6G1-14985-00	REC6G1-14546-00			
6C	6M80	2001	REC6G1-14301-01	REC6G1-W0093-00	REC6G1-14985-00	REC6G1-14546-00			
6D	6M90-6M91	2001-02	REC6G1-14301-01	REC6G1-W0093-00	REC6G1-14985-00	REC6G1-14546-00			
6CMH, CMHS, CMHL, MSHA, MSHB, MSHG, MSHD, MH, MHL, CWH	6M81-6M89	2002-10	REC6G1-14301-01	REC6G1-W0093-00	REC6G1-14985-00	REC6G1-14546-00			
CMH, CMHL, CM, MH	6M8A-6M8B	2010-12	REC6G1-14301-01	REC6G1-W0093-00	REC6G1-14985-00	REC6G1-14546-00			
8N	6G1	1984	REC6G1-14301-01	REC6G1-W0093-00	REC6G1-14985-00	REC6G1-14546-00			
8C, CEM	6G1	1984-95	REC6G1-14301-01	REC6G1-W0093-00	REC6G1-14985-00	REC6G1-14546-00			
8J	6G1	1986	REC6G1-14301-01	REC6G1-W0093-00	REC6G1-14985-00	REC6G1-14546-00			
8C, TRV, MSH	6N0	1997-98	REC6G1-14301-01	REC6G1-W0093-00	REC6G1-14985-00	REC6G1-14546-00			
8C, MSHZ, MSHA	6N00-6N09	2001-10	REC6G1-14301-01	REC6G1-W0093-00	REC6G1-14985-00	REC6G1-14546-00			
8CMH, CMHS, CMHL	6N0A-6N0C	2011-12	REC6G1-14301-01	REC6G1-W0093-00	REC6G1-14985-00	REC6G1-14546-00			
9.9FMH, FMHS, FMHL, FEMH, MHW, MSH, MSHZ, MSHA, MSHB, MSHC	63V-63V9	1995-10	REC63V-14301-00	REC63V-W0093-00	REC63V-14985-00	REC6G1-14546-00			
FMH, FMHS, FMHL, MH	63VA-63VJ	2011-16	REC63V-14301-00	REC63V-W0093-00	REC63V-14985-00	REC6G1-14546-00			
13.5AWH	63V	1998	REC63V-14301-00	REC63V-W0093-00	REC63V-14985-00	REC6G1-14546-00			
13.5AMH, AMHS, AMHL	66S1-66S2	2003-04	REC63V-14301-00	REC63V-W0093-00	REC63V-14985-00	REC6G1-14546-00			
15F.FEMH, FMHS, MHW, MSH, MSHA	63W-63W1	1995-02	REC63V-14301-00	REC63V-W0093-00	REC63V-14985-00	REC6G1-14546-00			
E15CMHS	65F2	2003	REC63V-14301-00	REC63V-W0093-00	REC63V-14985-00	REC6G1-14546-00			
E15D	6B4	2003+	REC6B4-14301-00	REC63V-W0093-00	REC63V-14985-00	REC6G1-14546-00			
15FMHS, FMHL, FMH, MH, MSHB, MSHC, MSHG	63W2-63W9	2003-10	REC63V-14301-00	REC63V-W0093-00	REC63V-14985-00	REC6G1-14546-00			
15FMHS, FMHL, FMH, MH	63WA-63WG	2011-16	REC63V-14301-00	REC63V-W0093-00	REC63V-14985-00	REC6G1-14546-00			
25VE	61R	1996	REC61N-14301-04	REC61N-W0093-00	REC6L2-14385-00	REC61N-14392-00			
25VM	61R	1997	REC61N-14301-04	REC61N-W0093-00	REC6L2-14385-00	REC61N-14392-00			
E25A	61N	1998	REC61N-14301-04	REC61N-W0093-00	REC6L2-14385-00	REC61N-14392-00			
25VM	61R0	2001	REC61N-14301-04	REC61N-W0093-00	REC6L2-14385-00	REC61N-14392-00			
30G	61T	1996	REC61N-14301-04	REC61N-W0093-00	REC6L2-14385-00	REC61N-14392-00			
30GE	61T	1997	REC61N-14301-04	REC61N-W0093-00	REC6L2-14385-00	REC61N-14392-00			
40X, XW	66T	1998-00	REC66T-14301-60	REC66T-W0093-01	REC6E5-14385-02	REC6E5-14546-00			
40XMH	66T4-66T8	2003-05	REC66T-14301-60	REC66T-W0093-01	REC6E5-14385-02	REC6E5-14546-00			
40XMH, XMHS, XMHL	66TG-66TR	2009-12	REC66T-14301-60	REC66T-W0093-01	REC6E5-14385-02	REC6E5-14546-00			
E40X, MLH	66T	1998-00	REC66T-14301-60	REC66T-W0093-01	REC6E5-14385-02	REC6E5-14546-00			
E40X, XMH, XMHS, XMHL, MLHZ	66T0-66T8	2001-05	REC66T-14301-60	REC66T-W0093-01	REC6E5-14385-02	REC6E5-14546-00			
E40X, XMHS, XMHL, XMHL, XMHLX	66TA-66TR	2006-12	REC66T-14301-60	REC66T-W0093-01	REC6E5-14385-02	REC6E5-14546-00			
E60H, HMHD, HMHDS, HMHDL, ELHB, MHZ, MLHA, HMHDX, HWHD	69D0-69D9	2001-10	REC6K5-14301-03	REC6H3-W0093-02	REC6G1-14985-00	REC6H3-14590-00			
E60HMHD, HMHDS, HMHDL, HWDL	69DA-69DC	2011-12	REC6K5-14301-03	REC6H3-W0093-02	REC6G1-14985-00	REC6H3-14590-00			
E60HE, HM, E-60H	6K5	1996-00	REC6K5-14301-03	REC6H3-W0093-02	REC6G1-14985-00	REC6H3-14590-00			





JUNTAS CARBURADORES

CARBURETOR GASKETS

GUARNIZIONI CARBURATORI

JOINTS DE CARBURATEUR

REF	OEM
REC6H4-14984-00	6H4-14984-00
	25 - 90 HP





*new*

REF	OEM
REC6F5-14483-00	6F5-14483-00
	E40/40J (2003+)





*new*

REF	OEM
REC6F5-14384-00	6F5-14384-00
	E40GMH/JMH 40GWH/JWH





REF	OEM
REC6F5-14398-00	6F5-14398-00
	E40GMH/JMH 40GWH/JWH





REF	OEM
REC677-14384-01	677-14384-01
	E8D/DMH 9.9D 15D





REF	OEM
REC677-14227-00	677-14227-01
	E8D/DMH 9.9D 15D





REF	OEM
REC6E7-14227-00	6E7-14227-00
	9.9D 15D





REF	OEM
REC63V-14984-00	63V-14984-00
	9.9F/FM/FEM/MS/MH/E9.9DMH 13.5AW 15F/FEM/MSH/FMH/MH E15DMH





REF	OEM
REC63V-14126-00	63V-14126-00
	9.9F/FM/FEM/MS/MH/E9.9DMH 13.5AW 15F/FEM/MSH/FMH/MH E15DMH





REF	OEM
REC6L2-14399-00	6L2-14399-00
	20DM/D/DEO/MLH E25A 25VE/VM/B/BMH/BWH/HMH/NMH/NE/N/ MLH/D 30G/GE E30HMH





REF	OEM
REC6L2-14384-00-00	6L2-14384-00
	20DM/D/DEO/MLH E25A 25VE/VM/B/BMH/BWH/HMH/NMH/NE/N/ MLH/D 30G/GE E30HMH





REF	OEM
REC648-14384-01-00	648-14384-01
	20C/CM 25D/DE 30A





REF	OEM
REC6H3-14457-01	6H3-14457-01
	25Q 40V/TLR/H C40T 50G/H
	E60H 60F/TR 70B





REF	OEM
REC66T-14384-01	66T-14384-01
	E40XM/X/MLH/XW 40XW/XM





REF	OEM
REC66T-14536-01	66T-14536-01
	40X/E40X/E40M



REF	OEM
REC676-14984-00-00	676-14984-00
	75A/AE/AET/AEM E75B 85A/AE/AET/AED



REF	OEM
REC64D-14384-1	64D-14384-01
	100A/AETO/TLR 115A/B/BE/CE/BETO 130BETO 140AETO 150CET/ETD/AETO/ CETO 175AETO/BETO/ET 200ETD 200CETO/AET/BET 225BET/AET 175D/DET
	150F/FET/TXR/AET 200AET/TLR/F/FET 225D/DET 115B/CET/TXR/TLR 130BET 250G/GET



KITS CARBURADORES



CARBURETOR KITS

KIT CARBURATORI

KIT CARBURATEUR

REF	OEM
REC6A1-W0093-01	6A1-W0093-01
 2B (1985-1988)	



REF	OEM
REC677-W0093-00	677-W0093-00
 9.9D (1985) 15D (1985)	

REF	OEM
REC6G1-W0093-00	6G1-W0093-00
 3A/AMH//MSH/ (1988-07) 6C/CEM/N/J (1984-96) 8C/CEM/N/J (1984-96)	

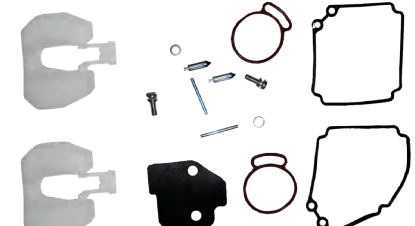

REF	OEM
REC6E7-W0093-01	6E7-W0093-04
 9.9D (1990-93) 15D (1990-93)	



REF	OEM
REC67D-W0093-00	67D-W0093-00
 F4 (1999-02) F4A/AMH/MSH (1998-02)	

REF	OEM
REC6L2-W0093-00	6L2-W0093-00
 20D/M (1998-11) 25N/M (1988-14)	

REF	OEM
REC66M-W0093-01	66M-W0093-01
 F9.9C/FT9.9D (1998-08) F15A/ELH/MHZ/PL (1998-07)	

REF	OEM
REC689-W0093-02	689-W0093-02
 20C/CM (1992-02) 25D/DE (1992-01) 30A (1992)	

REF	OEM
REC63V-W0093-00	63V-W0093-00
 9.9MH/FMH (1995-12) E9.9 13.5AMH (2003-04) 15FMH/MH (1995-12) E15DMH (2003)	

REF	OEM
REC8542561	65W-W0093-02
 F20A (2006-09) F25A/E (2006-09) FT/T25B/T (2006-09) F40B (2006-09) F30A (2006-09)	

new

YAMAHA

RECAMBIOS MARINOS

REF	OEM
REC6H4-W0093-03	6H4-W0093-03
	25QEO (1993-1994) 40V/VM/VE (1995-14) C40T/TL (1995-02) 40YET (2005-07) 50H/HR/HM/HW/HE (1995-03)



REF	OEM
REC6E9-W0093-02	6E9-W0093-02
	40G/QE/QE-2/QM (1992-99)





REF	OEM
REC6H2-W0093-10	6H2-W0093-10
	25B/BETO (1994-1995) 50G/GE (1993-1998) 60FE/TL/TR (1992-2007) 70B/BE (1992-2014)

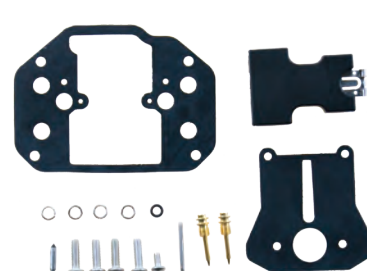

REF	OEM
REC6F6-W0093-00	6F6-W0093-00
	E40 (2003)



REF	OEM
REC61N-W0093-00	61N-W0093-00
	25VE/VM (1996-01) 25B/BMH/BW (2001-10) E30HMH (2003) 30G/GE (1996-00) 30HMH/HW (2003-12)



REF	OEM
REC6E9-W0093-03	6E9-W0093-03
	40QEZ/QWC (1997-98) C40 2Cyl (1995-98)



REF	OEM
REC6H4-W0093-01-00	6H4-W0093-01
	40H/E (1985-88) 50D (1985-88)

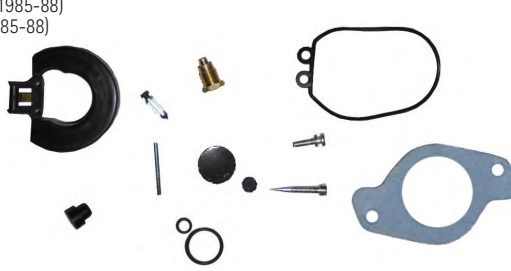

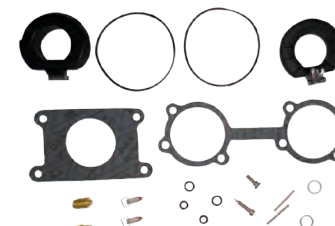

REF	OEM
REC696-W0093-00	696-W0093-02
	E48CMH (2003) 55B/BE/BM (1992-02) E55CMH (2003-05)
	Para dos carburadores For two carburetors Contenuto per due carburatori Pour 2 carburateurs



REF	OEM
REC66T-W0093-01	66T-W0093-01
	40XMH/XW (2000-13) E40X/MLH/XM (2000-13)





REF	OEM
REC84419M	696-W0093-01 696-W0093-02
	E48CMH (2003) 55B/BE/BM (1992-02) E55CMH (2003-05)





new





REF	OEM
REC6H1-W0093-01-00	6H1-W0093-01
	60FE-T/FEO (1985-91) 70B/BEH/CEL (1985-90)





REF	OEM
REC6N6-W0093-02	6N6-W0093-02
	115BETO/CETO (1990-91) L/130 BETO (1990-91)



REF	OEM
REC6H3-W0093-02	6H3-W0093-02
	E60H/MHZ/MLH/HMHD/HW/ HEHM (1997-14)





REF	OEM
REC6E5-W0093-08	6E5-W0093-08
	115 BE (1997)



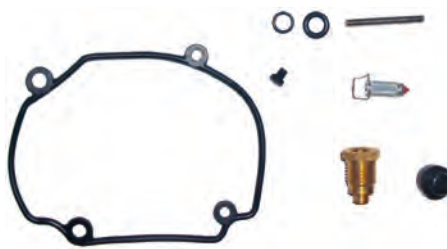

REF	OEM
REC6H0-W0093-00	6H0-W0093-00
	C80 (1997)





REF	OEM
REC6E5-W0093-06	6E5-W0093-06
	115B/BETO/CEO/CETO (1992-1995) 130BETO (1993-1995) L150CETO (1992-1995) 175BETO (1992-95) 200BETO (1992-95) 200CETO (1992-93) 225BETO (1993-95)



REF	OEM
REC6H1-W0093-10	6H1-W0093-10
	75CET (1998-2014) 75TLR (2000-02) 80A (2000-02) 90AE/TR/TL (1992-14)





REF	OEM
REC64D-W0093-00	64D-W0093-00
	150A/AET/GET/FET/F (1996-00) 175DET/FET (1996-00) 200F/FET/G/GET (1996-00) 225D/DET (1996-97)



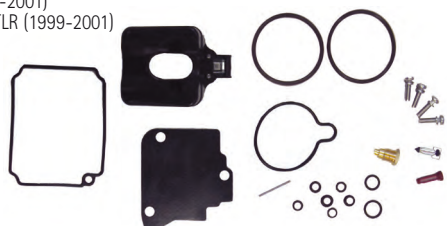

REF	OEM
REC67F-W0093-00	
	F80A/TLR/ (1999-2001) F100A/TLR/TRZ/TLR (1999-2001)





REF	OEM
REC6K7-W0093-09	6K7-W0093-09
	225AET (1987-91) PROV200 (1991) 150CET (1990-91) 175 BETO (1990-91) 200BET/ET (1990-91) 225BET(1990-91)



REF	OEM
REC6E5-W0093-07	6E5-W0093-07
	115BE/B (1996-2002) 115C/CET (2007-13) 130B/9BET (2007)



REF	OEM
REC61A-W0093-01	61A-W0093-01
	225C/CET (1994-95) 250B (1995-02) 250A/AET (1992-06)





AGUJA CARBURADOR

NEEDLE VALVE

SPILLO CONICO  
CARBURATORE

SIEGE, POINTEAU ET  
GICLEUR

REF	OEM
REC61N-14392-00	62Y-14392-00

2.5>60HP



REF	OEM
REC6G1-14546-00	6G1-14546-01

8>40HP



REF	OEM
REC626-14390-90	626-14390-90

9.9D/15D



REF	OEM
REC677-14343-68	677-14343-68

9.9D/15D



REF	OEM
REC6E8-14390-12	6E8-14390-12

9.9-15HP  
E8D/9.9D/15D



REF	OEM
REC6E5-14546-00	6E5-14546-00

25-250HP



REF	OEM
REC6F5-14390-21	6F5-14390-21

40G/E40G  
40J/E40J



REF	OEM
REC6F6-14341-00	6F6-14341-00

40G/40J  
E40G/E40J



REF	OEM
REC696-14590-01	696-14590-01

48-55HP  
E48CMH  
E55CMH



REF	OEM
REC6H3-14590-00	6H3-14590-01

E60/60FE/TR  
70BET/TR  
F80-F100



REF	OEM
REC688-14947-00	688-14947-00

75A/AE  
85A/AE



REF	OEM
REC692-14590-01	692-14590-00 692-14590-01

75A,C,TLR (1990-16)  
80A (1984-02)  
85A (1990-03)  
90A,T (1984-18)



new

TORNILLOS CARBURADOR

BOLT SCREW

VITE CARBURATORE

VIS DE CARBURATEUR

REF	OEM
REC624-42542-00	90387-06119

3>300HP



REF	OEM
REC647-14323-00	647-14323-00

E8D  
4A/MS  
9.9D  
20C

5C  
15D  
25D  
30A



REF	OEM
REC6F5-14323-00	6F5-14323-01



E40G/E40J  
40G/40J





REF	OEM
REC692-14923-00	692-14923-00



40>90HP







REF	OEM	
REC679-14923-00	679-14923-00	
 9.9F/M E9.9D 15F/M E15D	13.5 AM 8N/C/J 6C/D/TR/M 3A	



REF	OEM	
REC663-14923-00	663-14923-00	
 E48C 55B E55CMH		



REF	OEM	
REC6A0-14325-00	6A0-14325-00	
 15>300HP		

REF	OEM	
REC6E5-14328-01	6E5-14328-01	
 115>225HP		



REF	OEM	
REC50M-14355-00	50M-14355-00	
 20>50HP		



REF	OEM	
REC64D-14394-00	64D-14394-00	
 115-225HP		

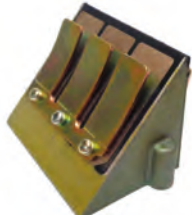

REF	OEM	
REC66T-14992-00	66T-14992-00	
 40X/E40X/E40M		

REF	OEM	
REC6E5-14323-03	6E5-14323-03	
 115>250		

VÁLVULA DE LÁMINAS    VALVE OF SHEETS    VALVOLA    CLAPET D'ADMISSION

REF	OEM	
REC6F6-13610-00	6F6-13610-00	
 40G/E40G 40J/E40J		

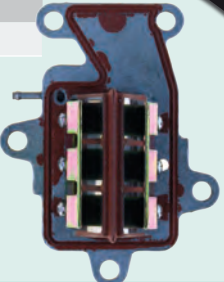
REF	OEM	
REC688-13610-00	688-13610-00	
 75A,C,T / E75 (1990+) 80A (1984-02) 85A (1900+) 90A,TR,TLR (2003+) 2T/Strokes		<b>new</b>

REF	OEM	
REC63W-13610-00	63W-13610-00	
 9.9/15 HP (1995+) 2T/Strokes		<b>new</b>

PASADOR DE BOYA    PIN FLOAT    SPINOTTO GALLEGGIANTE    AXE DE FLOTTEUR

REF	OEM	
REC688-14548-00	688-14548-00	 3>90HP
REC676-14186-00	676-14186-00	3>100HP 4AC/M/AS FT/F9.9A/B 5C/CM/CS
REC647-14386-10	647-14386-10	T9.9EL 9.9D F8AM/BM 15D
PAF25-05070019	6H4-14548-00	9.9>100HP
REC6E5-14386-01	6E5-14386-01	9.9>200HP

REF	OEM	
REC663-14548-00	663-14548-00	E48C 55B E55CMH
REC6E5-14386-02	6E5-14386-02	115>200HP



BOYAS

FLOATS

GALLEGGIANTE

FLOTTEUR DE CARBURATEUR

REF	OEM
REC6G1-14985-00	647-14323-00



3A/M	70B
E60	40N-H
8C-M/T	50E-D
60F	6C/M/D

REF	OEM
REC648-14385-00	648-14385-00



20C
25D
30A

REF	OEM
REC647-14385-00	647-14385-00



4AC
5C
9.9D
15D

REF	OEM
REC6F6-14385-00	6F6-14385-00



40G/J
E40G/J

REF	OEM
REC6E7-14385-00	6E7-14385-00



4AC
5C
E8D
9.9D
15D

REF	OEM
REC676-14985-01	676-14985-01



40Q
75A
E75B
80A
85A
90A/E

REF	OEM
REC676-14966-00	679-14966-00



8>100HP
---------

REF	OEM
REC6E5-14385-02	6E5-14385-02



40X	175D/A
E40	200A
100A	200G/F/B
115C	225D
115A-B	225A
130B	250G
150F/A	

REF	OEM
REC63V-14985-00	63V-14985-00



9.9F-M
13.5A
15F-M
F20
F25
F30
F40

REF	OEM	2T STROKES	4T STROKES
REC6H4-14985-01	6H4-14985-00 6H4-14985-01 650-14385-00 6M6-14385-00	✓ 25-90 hp	✓ 75-100 hp



**new**

REF	OEM
REC6L2-14385-00	6L2-14385-00



13.5>60HP
-----------

CONECTOR DE CARBURADOR

ACCELEROGRAPH CONTROL

CONTROLLO DELL'ACCELEROGRAFO

ATTACHE TIGE D'ACCELERATEUR

REF	OEM
PAF15-07000016	661-41262-01 661-41262-02



**new**

**ELEMENTO FILTRO DEL CARBURADOR**

**ELEMENT FILTER (CARB INLET)**

**FILTRO CARBURATORE**

**FILTRE DU CARBURATEUR**

REF	OEM
REC67F-14371-01	67F-14371-01
F75 (2003-04)	
F80 (2002-03)	
F90 (2003-04)	
F100 (2002-03)	



**ACCELERADOR**

**ACCELERATOR**

**ACCELERATORE**

**ACCELERATEUR**

**VARILLA DE ACELERADOR**

**ROD ACCELERATOR LEVER**

**ASTA ACCELERATORE**

**TIGE LEVIER ACCELERATEUR**

REF	OEM
REC6H3-41217-00	6H3-41217-00
50G/E60H	
60F/T	
70B/T	



REF	OEM
REC692-41256-00	692-41256-00
75A/B	
80A	
85A	
90A	



REF	OEM
REC688-41217-00	688-41217-00
80A	
90A/E	



REF	OEM
REC6G5-41217-00	6G5-41217-01
150/200ETN	
150/200AETO	
175AET-0	
225AETO	





# SISTEMA ELÉCTRICO ELECTRIC SYSTEM

# SISTEMA ELETTRICO SYSTÈME ÉLECTRIQUE

## SENSORES

## SENSORS

## SENSORE

## CAPTEURS

### SENSOR TPS

### TPS SENDER

### SENSORE TPS

### CAPTEUR TPS

REF	OEM
REC6C5-85885-00	6C5-85885-00



REF	OEM
REC6S1-85885-00	6S1-85885-00



REF	OEM
REC69J-85885-00	69J-85885-00



REF	OEM
REC68V-85885-00	68V-85885-00



### SENSOR MAP

### MAP SENSOR

### SENSORE MAP

### CAPTEUR MAP

REF	OEM
REC68V-82380-00	68V-82380-00



REF	OEM
REC68F-83688-10	68F-83688-10





REF	OEM
REC63P-82380-00	63P-82380-00



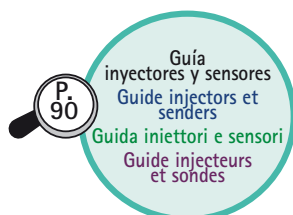

REF	OEM
REC68F-83688-00	68F-83688-00



SENSOR TEMPERATURA DEL AGUA		SENSOR, WATER TEMPERATURE		SENSORE TEMPERATURA ACQUA		CAPTEUR DE TEMPERATURE	
REF	OEM			REF	OEM		
PAF25-05010201	65W-85790-00			PAT40-05000100	6AH-82560-00		
<ul style="list-style-type: none"> <li>F20A (1998-06)</li> <li>F25A,E,M (1998-09)</li> <li>T25 / FT25 (1998-09)</li> </ul>				<ul style="list-style-type: none"> <li>F9.9H (2009+)</li> <li>F13.5B (2007-09)</li> <li>F15C,E,M (2007+)</li> <li>F20B, E, M (2007+)</li> </ul>			

REF	OEM	2T STROKES
REC688-82560-10	688-82560-10	40 - 300 hp (1984-16)



SENSOR ACCELERACIÓN TS		SENSOR		SENSORE ACCELERATORE TS		CAPTEUR D'ACCELERATEUR TS	
REF	OEM	2T STROKES	4T STROKES				
REC6X2-85885-10	6X2-85885-10 61A-85885-00	✓	✓				
80 - 300 HP							

SENSOR PRESIÓN DE ACEITE		SENSOR, OIL PRESSURE		SENSORE PRESIONE DELL'OLIO		SONDE DE PRESSION D'HUILE	
REF	OEM						
PAF15-07010103	65W-82504-00 62Y-82504-10						
F9.9 - F40							

SENSOR DE OXÍGENO		OXYGEN SENSOR		SENSORE OSSIGENO		SONDE À OXYGENE	
REF	OEM			REF	OEM		
REC67H-8592A-01	67H-8592A-01			REC68F-8592A-00	68F-8592A-00		
<ul style="list-style-type: none"> <li>LX200/5X200 (2001-05)</li> <li>DX150/LX150 (2001-05)</li> <li>SX150/VX150 (2001-05)</li> </ul>				<ul style="list-style-type: none"> <li>200HP (2001-2007)</li> <li>150HP (2001-2007)</li> <li>175HP (2001-2007)</li> <li>L, Z, V-PETO, TLR, NETO</li> </ul>			

BOBINAS

COILS

BOBINE

BOBINES

BOBINA DE LUZ

COIL LIGHTING

BOBINA LUCE

BOBINE D'ÉCLAIRAGE

REF	OEM	2T STROKES	4T STROKES
REC63V-85533-00	63V-85533-00	✓	
	9,9/15 F/M (1995+) 13,5 AM (2003-04) E9.9/15 (2003)		



REF	OEM	2T STROKES	4T STROKES
REC66T-85533-00	66T-85533-00	✓	
	E40 (1998+) 40X/M (1998+)		



REF	OEM	2T STROKES	4T STROKES
PAF15-07000400	66M-85533-00		✓
	F15 ALL (1998-07) F9.9 ALL (1998-08) F13.5 ALL (2002-07)		

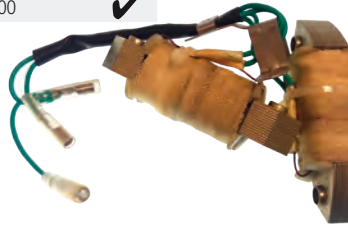

BOBINA DE IGNICIÓN

IGNITION COIL

BOBINA AVVIAMENTO

BOBINE D'ALLUMAGE

REF	OEM	2T STROKES	4T STROKES
REC6E0-85570-00	6E0-85570-00	✓	
	4A/M/C (1996-18) 5C (1996-15)		

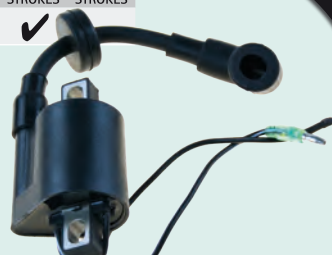



REF	OEM	2T STROKES	4T STROKES
REC6H3-85570-10	6H3-85470-10	✓	
	E60H/M (2001+) 60F (1984-91) 70B/C/E (1984-91)		



REF	OEM	2T STROKES	4T STROKES
REC6B4-85570-01	6B4-85570-00 6B4-85570-01	✓	
	E9.9D (2003-13) E15D (2003+)		





REF	OEM	2T STROKES	4T STROKES
REC6R3-85570-01	6R3-85570-01	✓	
	200 A/E/F (1997-10) 150 F/T (1994-07) 175D (1996-03) 225D (1996-09) 130 B/T (1994-07) 115 C/T (1994-13) 130 BETO (1994-01)		



REF	OEM	2T STROKES	4T STROKES
PAF25-05120000	65W-85570-01		✓
	F20A/E (1998-06) F25A/B/T/M (1998-09)		



REF	OEM	2T STROKES	4T STROKES
PAF15-07000600	66M-85570-00		✓
	F15 ALL (1998-07) F9.9 ALL (1998-08) F13.5 ALL (2002-07)		





REF	OEM	2T STROKES	4T STROKES
REC6F5-85570-11	F5-85570-13		✓

 F9.9 (2009+)  
 F20/25 B/F (2007+)  
 F13.5 B/M (2007+)  
 F15 C/M/E (2007-09)





REF	OEM	2T STROKES	4T STROKES
REC63V-85570-00	63V-85570-00 65E-85570-00	✓	

 9.9/15/13.5 (1995+)  
 E15 (2003) 63V & 63W  
 E15 (2003) 65F & 65G  
 9.9/15 F/M (1995-13)  
 13.5A (2003-04)  
 E15 (2003)



REF	OEM	2T STROKES	4T STROKES
REC697-85570-00	697-85570-00	✓	✓

 50G/ETOL (1995-07)  
 75T/L/A/C/B (1997-14)  
 85A/E/TDL/X (1997-03)  
 55 B/M/ET (1995-02)  
 90A/T/ETOL (1997-14)  
 60F/T/ETOL (1995-07)  
 70B/E/ETOL (1995-14)



REF	OEM	2T STROKES	4T STROKES
REC689-81311-40	66M-85570-00	✓	

 3A (1985-92)  
 40Q (1990-98)





REF	OEM	2T STROKES	4T STROKES
REC61N-85570-01	61N-85570-00 61N-85570-01	✓	

 20 D, DEM, MLH, MSH, DMH, DWQ, DWH (6L3 - 6L3A) (1994-11)  
 E25 A (61N) (1998)  
 25B, BMH, BWC, BWHVM (61R0 - 69RG) (2001-15)  
 E25 BMH (63P3 - 69PG) (2003-15)  
 25 N, NE, MLH, MSH, NMH, NW, MH (6L2 - 6L2G) (1994-15)  
 30 G, C30 ELRW (61T - 61T0) (1998-01)  
 330 HMH (60B3) (2003)



REF	OEM	2T STROKES	4T STROKES
REC6E5-85570-11	6E5-85570-11 6E5-85570-10	✓	

 115HP 4Cil. (1984-91)  
 140A/E (1984-89)  
 150  
 175  
 200HP (1984-89)



REF	OEM	2T STROKES	4T STROKES
REC6A1-85570-00	6A1-85570-00	✓	

 2B,C,M (1995-10)



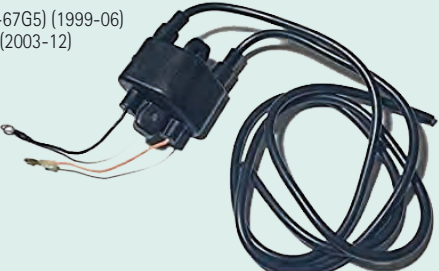

REF	OEM	2T STROKES	4T STROKES
REC67F-85570-00	67F-85570-00	✓	

 F80A/T (67G-67G5) (1999-06)  
 F100A/B/C/T (2003-12)



REF	OEM	2T STROKES	4T STROKES
REC697-85570-10	697-85570-11	✓	

 55HP 2 Cil. (1989-94)  
 90A/ETN/AETO (1984-88)  
 80A (1984-89)



REF	OEM	2T STROKES	4T STROKES
REC66T-85570-00	66T-85570-00	✓	

 E40 (1998+)  
 40X/M (1998+)





REF	OEM	2T STROKES	4T STROKES
REC6F6-85530-01	6F6-85530-01	✓	

new

EK40G (2018)  
E40G (2006+)

REF	OEM	2T STROKES	4T STROKES
REC6E7-85570-19	6E7-85570-19-00	✓	

9.9/15HP (1988-95)  
20C/D (1985-93)  
25C/D (1985-93)

**BOBINA DE T.C.I.**      **T.C.I. COIL**

REF	OEM	2T STROKES	4T STROKES
PAF2.6-04000600	69M-85640-00		✓

F2.5 ALL (2003+)

**BOBINE T.C.I.**      **BOBINE T.C.I.**

REF	OEM	2T STROKES	4T STROKES
PAF4-04000038	67D-85640-00		✓

F4 ALL (1998+)

**BOBINA DE CARGA**      **CHARGE COIL**

REF	OEM	2T STROKES	4T STROKES
REC63V-85520-00	63V-85520-00	✓	

F15 (1995+)  
9,9 F/M (1995+)  
13,5 A (2003-04)

**BOBINA DI CARICA**      **BOBINE DE CHARGE**

REF	OEM	2T STROKES	4T STROKES
REC66T-85520-00	66T-85520-00	✓	

E40 (1998+)  
40X/M (1998+)

REF	OEM	2T STROKES	4T STROKES
PAF15-07000300	66M-85520-00		✓

F15 ALL (1998-07)  
F9.9 ALL (1998-08)  
F13.5 ALL (2002-07)

REF	OEM	2T STROKES	4T STROKES
REC69P-85541-09	69P-85541-09	✓	

E25 B, BMH (69P1 - 69PG) (2001-15)  
25 B, BMH, BWC, BWH, MWS (69R1 - 69RG) (2001-15)  
E30 HMH (60B3) (2003)  
30 H, HMH, HWH, HWS, HWL, HW, HWC (69S3 - 69SG) (200315)

REF	OEM	2T STROKES	4T STROKES
REC6H3-85520-00	6H3-85520-00	✓	

E60H/M (2001+)  
60F (1984-91)  
70B/C/E (1984-91)

**new**

REF	OEM	2T STROKES	4T STROKES
REC6B4-85520-00	6B4-85520-00	✓	

E9.9D / E15D

**new**

BOBINA DE PULSACIÓN	PULSER COIL	BOBINE ACCENSIONE	BOBINE PULSEUR
---------------------	-------------	-------------------	----------------

REF	OEM	2T STROKES	4T STROKES
PAF20-05000100	6AH-85580-00		✓

F9.9H (2009+)  
F13.5B (2007-09)  
F15C/E/M (2007)  
F20/F30 (2009+)

**new**

REF	OEM	2T STROKES	4T STROKES
REC63V-85580-01	63V-85580-01	✓	

9,9/15 F/M (2003+)  
13,5A (2003-04)

REF	OEM	2T STROKES	4T STROKES
REC6B4-85580-00	6B4-85580-00	✓	

E9.9D / E15D

**new**

REF	OEM	2T STROKES	4T STROKES
REC66T-85580-00	66T-85580-00	✓	

E40 (1998+)  
40X/M (1998+)

REF	OEM	2T STROKES	4T STROKES
PAF25-05110000	65W-85580-00		✓

F25 ALL (1998-09)  
F40 E  
B (2000-09)  
F30 A  
ERZ  
ML (2001-09)

REF	OEM	2T STROKES	4T STROKES
PAF15-07000200	66M-85580-00		✓

F15 ALL (1998-07)  
F9.9 ALL (1998-08)  
F13.5 ALL (2002-07)

**BUJÍAS**

**SPARK**

**CANDELE**

**BOUGIES**

2T STROKES	REF CHAMPION	OEM
2	1984 CHAL90C	94703-00001
3	1988 CHAQL86C	94701-00248
5	1984 CHAQL82C	94701-00041
6	1986 CHAQL82C	94701-00041
8	1984 CHAQL82C	94701-00041
09/09/19	1984 CHAQL82C	94701-00041
20	1996 CHAQL82C	94701-00041
25	1999 CHAQL82C	94701-00041
30	1984 CHAQL82C	94701-00041
40	1984 CHAQL82C	94701-00041
50	1995 CHARA8HC	94701-00041
70	1984 CHAQL78C	94701-00195
90B	1984 CHAQL78C	94701-00195
90	1984-00 CHAQL78C	94701-00195
115	1984-05 CHAQL78C	94701-00195
130	1989 CHAQL78C	94701-00195
150 Carb	1996 CHAQL82C	94701-00248
150 EFI	1999-00 CHAQL78C	94701-00195
150 EFI	2000 CHARC12YC	94702-00401
150 MPDI	2000 CHARC12YC	94702-00401
150 VMAX	1997 CHAQL78C	94701-00195
175	1984 CHAQL78C	94701-00195

2T STROKES	REF CHAMPION	OEM
175 VMAX	1992 CHAQL78C	94701-00195
200 LX	1999 CHAQL78C	94701-00195
200 LZ	1999 CHARC9YC4	94702-00399
200 SX	1999 CHAQL78C	94701-00195
200 VX	2000 CHAQL78C	94701-00195
200 Z	2000 CHARC9YC4	94702-00399
225	2000 CHAQL77JC4	94701-00309
	2000 CHAL77JC4	94701-00217
250	2000 CHAQL77JC4	94701-00309
	2000 CHAL77JC4	94701-00217

4T STROKES	REF CHAMPION	OEM
2,5F	2003 CHAQL86C	94701-00248
4F	1999 CHAQL86C	94701-00248
9.9Fi	1996 CHAZ9Y	94701-00282
9.9T	1996 CHAZ9Y	94701-00282
15F	1999 CHARA8HC	94701-00375
25F	1998 CHARA8HC	94701-00375
30F	2001 CHARA8HC	94701-00375
40F	1999 CHARA8HC	94701-00375
50F	1999 CHARA8HC	94701-00375
60	2002 CHARA8HC	94701-00375



P 49

REF RECO04



REF CHAPRO5U

	REF NGK	OEM
2B	NGKBR5HS	94702-00249-00
F2,5A/F4A	NGKBR6HS	94701-00248-00
3A/F6A/F8C/FT8D/F9,9F/F9,9J/FT9,9G/FT9,9L	NGKBR6HS-10	94702-00274-00
F4B/F5A/F6C	NGKCR6HS	94702-00372-00
4A/5C/20C/25D/40X	NGKBR7HS	94701-00110-00
6C/8C/9,9D/9,9F/15D/15F/20D/25N/25V/25B/30D/40H/40V	NGKBR7HS-10	94702-00271-00
F8B	NGKCR5HSB	94701-00300-00
F9,9A/F9,9B	NGKCR6HS	94701-00282-00
F9,9C/FT9,9D/F15A/F25A/FT25B/F30A/F40A/F40B/F50A/FT50B/FT50C	NGKDP6EA-9	94701-00375-00
F15C/F20B/F25D/F25G/FT25F/F30B/F40F/F50F/F50H/FT50G/FT50J/F60C/F60F/FT60D/FT60G	NGKDP6EB-9	94702-00418-00
40Q	NGKBR8HS	94701-00195-00
30G/50D/50G/50H/55B/60F/70B/75A/75C/80A/85A/90A/100A/115A/115B/115C/140A/150A/150C/150F/175A/175B/175D/200A/200B/200F/200G/225D/(L)250A/(L)250G	NGKBR8HS-10	94702-00247-00
F60A/FT60B	NGKDP6EA-9	94701-00406-00
F70A	NGKLR7E	94702-00429-00
F80A/F80B/F100A/F100B/F100D/F(L)150A/F(L)200A/F(L)225A	NGKLR5A-11	94702-00391-00
130B/140B/200C/225B/250B/225G (VMAX)	NGKBR9HS-10	94701-00309-00
F(L)115B	NGKLR6E	94702-00437-00
F(L)115A/F175A/F(L)200C/F(L)200F/F(L)200G/F(L)225B/F225C/F(L)250A/F(L)250B/F(L)300A/F(L)350A/F(L)225F/F(L)250D/F(L)300B	NGKLR6A-11	94702-00400-00
(L)Z150P/Z150Q (VMAX)	NGKBR6EKEU	94702-00405-00
Z175G/(L)Z200N/Z200P (VMAX)/(L)Z250D/Z250F (VMAX)/(L)Z300A	NGKBR7EKEU	94702-00404-00
STERN-DRIVE ESSENCE	NGKBR6FS	94701-00365-00

WAVERUNNER	REF NGK	OEM
XL800/XLT800/GP800/WB800/GP800R	NGKBR8ES	94701-00204
XLT1200/XL1200LTD/GP1200R/GP1300R	NGKBR8ES-11	94702-00396
SJ650/650T/650TL/650TX/FX1/PRO TX700/WB700/XL700/WVT700/W.RAIDER 760/WVT760/XL760/WB760/GP760/W.RAIDER 1100/WVT1100/SUV1200/GP1200/XL1200	NGKBR8HS	94701-00195
SJ700/W.RAIDER 700	NGKBR7HS	94701-00110
FX140/FX140 CRUISER/FX160/FX160 CRUISER/FX1100 HO/HO CRUISER/VX 1100 SPORT & DELUXE	NGKCR9EB	94702-00409



# VOLANTE DE MOTOR

## FLYWHELL

## VOLANTE MOTORE

## VOLANT MOTEUR

### SIN DIENTES (MANUAL)

### WITHOUT TOOTH

### SENZA DENTI (MANUALE)

### MANUEL SANS DENT

REF	OEM
PAF20-05000500	6AH-85550-00

  
 F9.9H (2009+)
   
 F13.5B (2007-09)
   
 F15C,E,M (2007+)
   
 F20B, E, M (2007+)

REF	OEM
PAF15-07070000	66M-85550-00

  
 F9.9C, M (1998-08)
   
 FT9.9D (1999-08)
   
 F13.5A (2002-07)
   
 F15A,E,M (1998-07)

REF	OEM
PAF25-05150000	65W-85550-01

  
 F20/F25 (A) (1998-08)
   
 F40B/E/T (2000-09)
   
 FT/T25 (2000-09)
   
 F30A/E/M (2001-09)

### ELÉCTRICO

### ELECTRIC

### ELETTRICO

### ÉLECTRIQUE

REF	OEM
PAF20-05000500W	6AH-85550-10

  
 F9.9H (2009+)
   
 F13.5B (2007-09)
   
 F15C,E,M (2007+)
   
 F20B, E, M (2007+)

REF	OEM
PAF15-07070100W	66M-85550-10

  
 F9.9C, M (1998-08)
   
 FT9.9D (1999-08)
   
 F13.5A (2002-07)
   
 F15A,E,M (1998-07)



# MOTORES DE ARRANQUE

# STARTERS

# MOTORINI AVVIAMENTO

# DEMARREUR

REF	OEM			2T STROKES	4T STROKES	
PH130-0061	6L2-81800-10, 11, 12 682-81800-10, 11, 12	12V 0.4 kw	10 CCW	✓		REC89-825096T01
	9.9-15HP (1984-97) 25HP (1988-98) 6HP (1984-90) 8HP (1984-90)					



REF	OEM			2T STROKES	4T STROKES	
PH130-0049	689-81800-10, 11, 12, 13	12V 0.6 kw	11 CCW	✓		REC89-825096T01
	25-40HP 30HP/20HP					



REF	OEM			2T STROKES	4T STROKES	
PH130-0062	6J4-81800-00, 01 6G8-81800-10, 11 6F5-81800-10, 11	12V	11 CCW	✓		REC89-825096T01
	30 HP (1987+) 40-50 HP (1989+)					



REF	OEM			2T STROKES	4T STROKES	
PH130-0084	66M-81800-00, 01, 02	12V	9 CCW	✓		REC89-825096T01
	F9.9, F15, F13.5 (1998-08)					



REF	OEM			2T STROKES	4T STROKES	
PH130-0005	6E5-81800-10, 11, 12	12V 1.1 kw	9 CCW	✓	✓	REC61A-81941-00
	F45 / F50 115-130 HP V4 150-175-200 HP V6					



REF	OEM			2T STROKES	4T STROKES	
PH130-0028	67C-81800-00, 01, 02	12V	9 CCW		✓	PH375-0036
	F30 (2000-09) F40 (2001-09)					

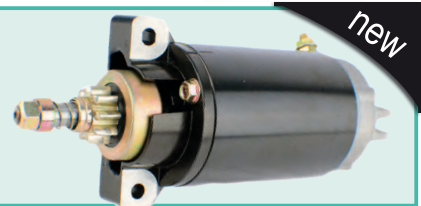

REF	OEM			2T STROKES	4T STROKES	
PH130-0063	6H4-81800-10, 11, 12	12V	9 CCW	✓		
	40-50 HP (1984-1988)					



REF	OEM			2T STROKES	4T STROKES	
PH130-0051	99999-03938 61H-81800-00, 01 6K7-81800-10 6N7-81800-00, 01, 10	12V 1.4 kw	9 CCW	✓		PH375-0047
	115-250HP V4					



REF	OEM			2T STROKES	4T STROKES	
PH130-0059	61A-81800-00, 01 69L-81800-00 69W-81800-00	12V	9 CCW	✓	✓	REC61A-81941-00 REC89-825096T01 (F40/50/60)
	V200 (1998+) F40 (2002-06) F50 (2003-14)	F60 (2003-07) 225 HWP (1994+) 250 HP (1990+)				



YAMAHA

RECAMBIOS MARINOS

REF	OEM			2T STROKES	4T STROKES	
PH130-0050	6H3-81800-10, 11	12V 0.6 kw	9 CCW	✓		REC688-81950-10
	50HP (1993-14) 60HP (1991+) 70HP (1984-14)					

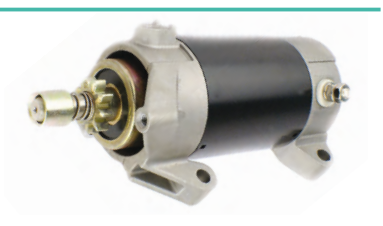

REF	OEM			2T STROKES	4T STROKES	
PH130-0007	99999-03249 697-81800-10, 11, 12 676-81800-10	12V 1.0 kw	9 CCW	✓		
	55-60HP 2 cyl					



REF	OEM			2T STROKES	4T STROKES	
PH130-0058	688-81800-10, 11, 12	12V	9 CCW	✓		REC688-81950-10
	75 HP (1994-99) 85 HP (1991-96) 90 HP (1984-14) 85HP (1992-03) 80HP (1993-02)					

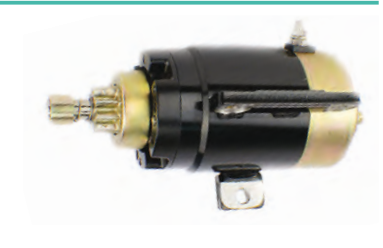

REF	OEM			2T STROKES	4T STROKES	
PH130-0056	6CJ-81800-00 6C5-81800-00 68F-81800-00, 01, 03	12V 1.4 kw	13 CCW	✓	✓	
	LZ 150-175 HP (2000+) VZ 150-175 HP (2000+) Z 150-175 HP (2000+) LZ 200-Z200 HP (2000+)					

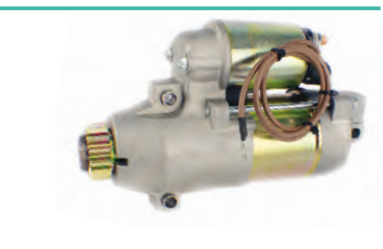

REF	OEM			2T STROKES	4T STROKES	
PH130-0034	66M-81800-01, 02	12V	9 CCW		✓	PAF15-05170300W
	F9.9 F13.5 F15 HP (2000-08)					



REF	OEM			2T STROKES	4T STROKES	
PAF20-05000900W	6AH-81800-00, 01	12V	11		✓	
	F13,5 ALL (2007-09) F15 (2007-14) F20 ALL (2007-14)					



REF	OEM			2T STROKES	4T STROKES	
PH130-0029	65W-81800-00, 01, 02, 03	12V	9 CCW		✓	PH375-0034
	F20 F25HP (1999-09) F30/F40 (2005-09)					

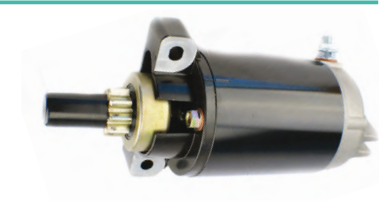

REF	OEM			2T STROKES	4T STROKES	
PH130-0057	68V-81800-00, 01, 02	12V 1.4 kw	13 CCW		✓	
	F80 (2005+) F100 (2005+) F115 (2000+) LF115 (2000+)					



REF	OEM	⚡	☀️	2T STROKES	4T STROKES
PH130-0055	67F-81800-01, 02, 03, 04	12V 1.4 kw	13 CCW	✓	✓

F80 HP (1999+)  
F100 HP (1999+)



REF	OEM	⚡	☀️	2T STROKES	4T STROKES
PH130-0074	69J-81800-00, 01	12V 1.4 kw	13 CCW	✓	✓

F200, F225 HP (2002-2007)



REF	OEM	⚡	☀️	2T STROKES	4T STROKES
PH130-0073	63P-81800-00 6BR-81800-00, 01	12V 1.4 kw	13 CCW	✓	✓

FL, F150 AET, X, L (2009-11)  
FL, F200 CETX (2009-11)  
FL, F225 BET  
X, U, CET, L (2009-11)  
FL, F250 AET, X, U, BET, X, U (2009-11)



REF	OEM	⚡	☀️	2T STROKES	4T STROKES
PH130-0076	60V-81800-00 60X-81800-00 6C9-81800-00 6D0-81800-00	12V 1.4 kw	13 CCW	✓	✓

250HP (2003-07)



MUELLE DE ARRANQUE    STARTER SPRING    MOLLA AVVIAMENTO    RESSORT DE LANCEUR

REF	OEM	2T STROKES	4T STROKES
PAF15-07130107	63V-15713-00	✓	✓

6 - 25 hp



**new**

REF	OEM	2T STROKES	4T STROKES
REC66T-15713-00	66T-15713-00 6F5-15713-00, 01	✓	✓

25 - 40 hp



**new**

TRINQUETE TRACCIÓN    PAWL, DRIVE    CRICCHETO TRAZIONE    ENTRAÎNEMENT

REF	OEM	2T STROKES	4T STROKES
PAF15-07130202	63V-15741-00	✓	✓

6 - 40 hp



REF	OEM
PAF15-07130203	63V-15767-00
PAF15-07130204	63V-15784-00



PAF15-07130203      PAF15-07130204

**new**

CABLE DE MOTOR DE ARRANQUE A BATERIA    CONNECTION LINE, POWER    CAVO MOTORE DI AVVIAMENTO A BATTERIA    CABLE DE CONNEXION

REF	OEM
PAT85-05000023	6C5-82105-01 6HO-82105-02, J2

-60 hp



**new**

**TIRADOR DE ARRANQUE**    **STARTER HANDLE ASSY**    **MANIGLIA AVVIAMENTO**    **POIGNEE DE LANCEUR**

REF	OEM
PAF4-04130100	6G1-15755-00 6G1-15779-00



new

**PLATO Y PLACA DE ARRANQUE MANUAL**    **PLATE & DRUM, DRIVE**    **PLACCA E PIATTO DI AVVIAMENTO MANUALE**    **TAMBOUR, POULIE**

REF	OEM	2T STROKES	4T STROKES
PAF15-07130201	63V-15714-00	✓	✓
PAF15-07130001	63V-15716-00	✓	✓



PAF15-07130201



PAF15-07130001

new

**LLAVES DE ARRANQUE**    **IGNITION STARTER SWITCH**    **CHIAVI DI ACCENSIONE**    **CONTACTEUR A CLÉ**

**MONTAJE EN MANDO DE CONTROL**    **CONTROL BOX**    **MONTAGGIO NEL TELECOMANDO**    **MONTAGE POUR BOITIER DE COMMANDE**

REF	OEM	2T STROKES	4T STROKES
PAF15-13000200W	703-82510-12	✓	✓



**MONTAJE EN PANEL**    **DASH MOUNT**    **MONTAGGIO NEL PANNELLO**    **MONTAGE POUR TABLEAU DE BORD**

REF	OEM	2T STROKES	4T STROKES
REC61B-82510-02	61B-82510-01	✓	



**LLAVE DOBLE INSTALACION**    **DUAL ENGINE APPLICATION**    **CHIAVE DOPPIA INSTALLAZIONE**    **POUR INSTALLATION DOUBLE**

REF	OEM	2T STROKES	4T STROKES
REC6K1-82510-07	6K1-82510-06	✓	✓





LLAVE CON CHOQUE

PUSH T. CHOKE

CHIAVE CON CONTATTO

AVEC STARTER

REF	OEM	2T STROKES	4T STROKES
REC703-82510-44	703-82510-43	✓	✓



LLAVE PARA MANDO POPERO

KEY FOR STERN CONTROL

CHIAVE PER COMANDO A GUIDA

CONTACTEUR A CLE COMPLET

new

REF	OEM	2T STROKES	4T STROKES
REC6H3-82510-03	6H3-82510-00, 01, 02, 03	✓	✓

- 55B (1992-00)
- E60H (1996-97)
- 75A (1992-95)
- 85A (1995)



SOLENOIDE RELE

SOLENOID RELAY

SOLENOIDE RELE

SOLENOIDE RELAIS

REF	OEM
PH375-0034	65W-81941-00
F20	(1998-09)
F25	(1998-09)
F30	(2001-09)
F40	(2000-09)



REF	OEM
REC688-81950-10	688-81950-10
50G	80A
50D	90A
E60	60F
70B	



REF	OEM
REC61A-81941-00	61A-81941-00 6E5-81941-11
150	175
200	115
225	130
250	100HP



REF	OEM
REC89-825096T01	6E5-81950-01 6G1-81940-00
6 - 90 HP	



new

REF	OEM
PH375-0042	68V-8194A-00 68N-81940-00
F40 - F200	(2000-16)
Z / LZ / VZ200	(2004-07)
Z / LZ / VZ250	(2003-07)
Z / LZ / VZ300	(2004-07)



REF	OEM
PAF15-05170300W	6G1-81941-10
6 - 90 HP	



new

REF	OEM
REC61A-81950-01	61A-81950-00, 01

50 -250 hp (1990-16) 2 Strokes  
F20, F25 (1998-09) 4 Strokes



REF	OEM
REC68V-81950-00	68V-81950-00

20 - 300 HP



REF	OEM
REC6AW-8194A-00	6AW-8194A-00

F30 / F40 (2009+)  
F300 (2008-11)  
F350 (2008+)



REF	OEM
REC60E-81950-00	60E-81950-00

30 - 115 HP



REF	OEM
REC63P-81950-00	63P-81950-00

F20 - F300



REF	OEM
REC6AW-81950-00	6AW-81950-00

F150C/G (2017+)  
F1475C (2017+)  
F200C/G (2013+)  
F225C/F (2011+)  
F250B/D/C (2009+)  
F300A/B/C (2008+)  
F350A/C/T (2008+)



REF	OEM	12V
REC60V-81950-00	60V-81950-00	12V

Z250D,T,F (2003-07)  
Z300A,T (2004-07)



REF	OEM	2T STROKES	4T STROKES
REC6H1-81950-01	6H1-81950-00, 01	✓	✓

30 / 40 / 45 / 50 / 60 HP (1995+)



REF	OEM
PH375-0048	6E5-8195A-01 6E5-8195C-01

100 (1996-01)  
115 (1991-13)  
130 (1991-07)  
150 (1998-07)  
175 (1996-03)  
200 (1991-10)  
225 (1996-09)  
F100 A/AET/TLR/TRZ (1999-06)  
F100 BET (2003-12)  
F100 CETL (2003)  
40X/E40MLH (1998-03)  
F80A/AET/TLR (1999-06)



REF	OEM
PH375-0047	6E5-81950-01

175HP (1991-96)  
200HP (1991-10)  
225HP (1996-09)  
150HP (1996-03)  
115HP (1995-13)  
100HP (1996-01)  
130HP (1991-07)



REF	OEM	2T STROKES	4T STROKES
REC68F-8195A-00	68F-8195A-00	✓	✓

150 --> 350 HP



## REGULADORES Y RECTIFICADORES

## REGULATOR AND RECTIFIERS

## REGOLATORI E RADDRIZZATORI

## REGULATEURS ET RECTIFIEURS

REF	OEM	2T STROKES	4T STROKES
REC6H2-81960-10	6H2-81960-10	✓	

 40  
 50  
 60  
 70

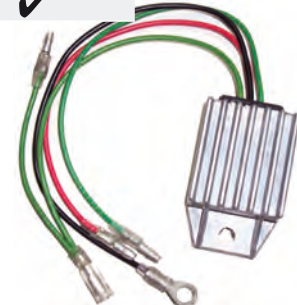



REF	OEM	2T STROKES	4T STROKES
REC6G1-81970-62	664-81970-60, 61, 62 676-81970-00 6E9-81970-70 6G1-81970-00, 60, 61, 62, A0	✓	

 4 Et 5 HP (1 cyl)  
 6, 8, 9.9, 15, 20, 25, 30, 40 (2 cyl)  
 40, 50, 55, 60, 70 (3 cyl)



REF	OEM	2T STROKES	4T STROKES
REC67F-81960-12	67F-81960-00	✓	

 F75AETL (2003)  
 F80A,TLR,TJRA (1999-06)  
 F90AET,TRB,TLRB (2003)  
 F100A,TLR,BET,CET (1999-12)



REF	OEM	2T STROKES	4T STROKES
REC6H0-81960-00	6H0-81960-00	✓	

 75A, AEM, AEHD  
 85A, AE, AED, AEDL, AEDH, AEDX, AET, AETL, AETX  
 E115 A, AE, AEL, AMH, AMHL, AET, AETL, AETX

693-6922 (1997-02)  
 688-688F (1997-15)  
 61U0-61UG (2001-15)



REF	OEM	2T STROKES	4T STROKES
REC6G5-81960-A0	6G5-81960-A0	✓	

 75 (1988-96)  
 85 1989-96)  
 90 (1984-91)  
 115 (1991-96)  
 130 (1988-89)  
 150 (1984-89)  
 150 (1997)  
 175 (1984-89)  
 200 (1984-89)



REF	OEM	2T STROKES	4T STROKES
REC6R3-81960-10	6R3-81960-10	✓	

 100A (1991)  
 115C (1990-13)  
 130B/T (1990-14)  
 150C/F/T (1990-13)  
 175B/D (1990-05)  
 200B/C (1991-93)  
 PROV200 (1991-94)  
 225B (1990-91)

**new**

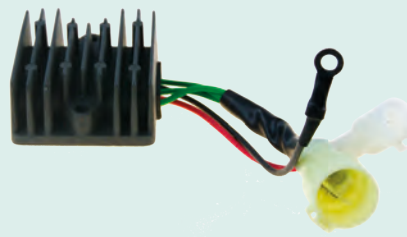

REF	OEM	2T STROKES	4T STROKES
PAT85-05030300	6AH-81960-00	✓	

 F9.9H (2009+)  
 F13.5B (2007-09)  
 F15C/E/M (2007+)  
 F20B/M (2007+)

**new**



REF	OEM	2T STROKES	4T STROKES
REC6P2-81960-03	6P2-81960-02,03	✓	

 F200A/C (2006-15)  
 F225A/B/C (2007-15)  
 F250A/B/T (2006-13)

**new**

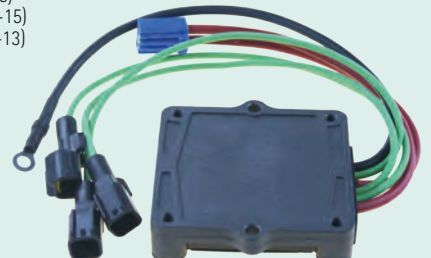

REF	OEM	2T STROKES	4T STROKES
REC63P-81960-02	63P-81960-00, 01, 02	✓	

 F150A,T,B,D,F (2004+)

**new**





REF	OEM	2T STROKES	4T STROKES
REC61A-81960-04	61A-81960-00, 01, 02, 03, 04	✓	

 225C/G (1994-03)  
 250A/B/E/G (1990-10)



REF	OEM	2T STROKES	4T STROKES
REC6G8-81960-A1	6G8-81960-A1		✓

 F8B (1990-99)  
 FT9.9D (1999-08)  
 F9.9C/A/B/M (1990-08)  
 F13.5A (2005-07)  
 F15A/M/E/P (1998-07)

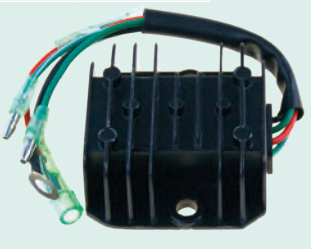

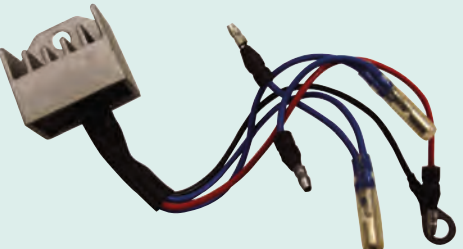

REF	OEM	2T STROKES	4T STROKES
PAF15-07060001	6J8-81960-00	✓	✓

 6 - 50 HP





REF	OEM	2T STROKES	4T STROKES
REC881346T	68V-81960-00 6D3-81960-00		✓

 T/FT/F50 (2005-06)  
 T/FT/F60C/D/T (2005-06)  
 F75B/T (2005)  
 F80B (2005-06)  
 F100D (2005-06)  
 F115A/T (2000-06)



REF	OEM	2T STROKES	4T STROKES
REC69J-81960-13	69J-81960-10, 11, 12, 13		✓

 F200A/T (2003-07)  
 F225A/T (2003-07)



REF	OEM	2T STROKES	4T STROKES
REC60V-81960-05	60V-81960-00, 01, 02, 03, 04, 05	✓	

 250D/F/T (2003-07)  
 300A/T (2004-07)

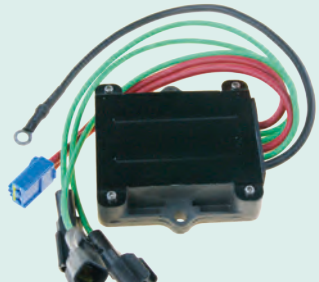

CDI Y CAJAS NEGRAS    CDI & POWER PACK    CDI E CENTRALINA    CDI ET BOITIER ELECTRONIQUE

REF	OEM	2T STROKES	4T STROKES
REC688-85540-00	688-85540-00	✓	

 E75 BMHD, BMHDL  
 75 A, AED, AEDL, AEM, AEHD, AET, AETL  
 75A  
 85, A, AE, AED, AEDL, AEDX, AEHD, AET, AETX  
 85A

6925 - 692Y (2003-15)  
 692 - 692Y (1997-15)  
 692E (2008)  
 688 - 688F (1997-15)  
 6886 - 6887 (2007-08)



REF	OEM	2T STROKES	4T STROKES
REC6G9-85540-29	6G9-85540-29 6G9-85540-22 6G9-85540-21 6G9-85540-20		✓





 F8B (1985-99)  
 F9.9B (1985-99)

2 CYL.









REF	OEM	2T STROKES	4T STROKES
PAF20-05000300	6AH-85540-00		✓

 F9.9H (2009+)  
 F13.5 B (2008-09)  
 F15C/E/M (2007+)  
 F20B/E/M (2007+)



REF	OEM	2T STROKES	4T STROKES
REC63D-85540-04	63D-85540-00, 01, 02, 03, 04		✓

 3 cyl  
 C40 (1996-03)  
 40V,E,Y (1995+) C50 (2000)  
 50H (1995-03)





REF	OEM	2T STROKES	4T STROKES
PAF15-07000500	66M-85540-10		✓

 F9.9C, M (2002-07)  
 F13.5 A (2002-07)  
 F155A,E,M,P (2002-07)







REF	OEM	2T STROKES	4T STROKES
REC6F6-85540-01	6F6-85540-01		✓

 E40G (2008-16)







REF	OEM	2T STROKES	4T STROKES
REC6H3-85540-11	6H3-85540-10, 11, 12		✓

 3 cyl (1984+)  
 60F/E60H,E,M  
 70E,B



REF	OEM	2T STROKES	4T STROKES
REC6H3-85540-13	6H3-85540-10, 11, 12, 13		✓

 60F (1984-91)  
 70B,E (1984-91)  
 E60H,E (2000+)







REF	OEM	2T STROKES	4T STROKES
REC63V-85540-00-01	63V-85540-00, 01, 02		✓

 9.9 - 15HP (1995+)  
 63V & 63W







REF	OEM	2T STROKES	4T STROKES
REC6H2-85540-13	6H2-85540-10, 11, 12, 13		✓

 50G (1997-07)  
 60F,T (1997-10)  
 70B,T (1997-17)





REF	OEM	2T STROKES	4T STROKES
REC68T-85540-00	68T-85540-00		✓

 F6A/B/M (2001-05)  
 T/FT/F8C/M (2000+)  
 T/FT/F9.9F/M/J (2008+)





REF	OEM	2T STROKES	4T STROKES
REC6A1-85540-01	6A1-85540-00, 01		✓

 2B,M,C (1995-10)





REF	OEM	2T STROKES	4T STROKES
REC6G9-85540-29	6G9-85540-20, 21, 22, 29		✓

 F8B (1985-99)  
 F9.9B, M, E (1985-06)



REF	OEM	2T STROKES	4T STROKES
REC63V-85540-00-01	63V-85540-00,01	✓	
	9.9, 15HP (1995-08) 13, 5HP (2003-04)		





REF	OEM	2T STROKES	4T STROKES
REC6F5-85540-22	6F5-85540-22	✓	
	E40 (2003)		



REF	OEM	2T STROKES	4T STROKES
REC61N-85540-00	61N-85540-00	✓	
	25 (1997-07) 30 (1996-08) 200 (1993)		





REF	OEM	2T STROKES	4T STROKES
REC695-85540-11	695-85540-11,12	✓	
	E40 (2003) 9.9 (1986-95) 15 (1986-95) 20 (1985-02) 25 (1985-02)		





REF	OEM	2T STROKES	4T STROKES
REC6G0-85540-11	6G0-85540-11	✓	
	175 (1986-89) 200 (1986-89) 150 (1988) 225 (1987-89)		





REF	OEM	2T STROKES	4T STROKES
REC663-85540-15	663-85540-11,15	✓	
	55 (1990-93)		





REF	OEM	2T STROKES	4T STROKES
REC6E0-85540-71	6E0-85540-71,70	✓	
	4 (1984) 5 (1984)		



REF	OEM	2T STROKES	4T STROKES
REC6E5-85540-12	6E5-85540-12,11,10	✓	
	115 (1984-89) 115 (1991-98) 130 (1988-89)		



REF	OEM	2T STROKES	4T STROKES
REC689-85540-21	689-85540-21,20	✓	
	25 (1984-87) 30 (1984-87) 30 (1989-90) 40 (1990)		



REF	OEM	2T STROKES	4T STROKES
REC6G5-85540-12	6G5-85540-12,11,10	✓	
	150HP (1984-89)		

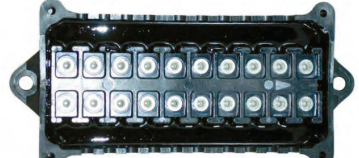

REF	OEM	2T STROKES	4T STROKES
REC696-85540-12	696-85540-12,11,10	✓	
	6 (1984-99) 8 (1984-04)		



REF	OEM	2T STROKES	4T STROKES
REC66T-85540-00-01	66T-85540-01	✓	
	40X/E40X MLH XW (1998+)		



REF	OEM	2T STROKES	4T STROKES
REC6B4-85540-01	6B4-85540-01	✓	

 E9.9 DMH-5 (2003+)  
 E15 DMH -5 (2003+)





REF	OEM	2T STROKES	4T STROKES
REC688-85540-16	688-85540-16	✓	

 75  
 85



REF	OEM	2T STROKES	4T STROKES
REC6J8-85540-H2	6J8-85540-H2	✓	

 25J/EO/SH (1999)  
 30D/ETOL/EOS/MHS  
 MHOL, E, L, H  
 (1999+)



DESCONECTORES DE SEGURIDAD CUT OFF SWITCHES CHIAVETTA DI SICUREZZA COUPE CIRCUIT DE SECURITE

REF	OEM
REC688-82575-01	688-82575-01

 9.9 --> 250 HP



REF	OEM
REC6E9-82575-02	6E9-82575-00

 E30/GE/BMH (1996-12)  
 25V/M/E/B (1996-10)  
 6/8C/TRV/MSH (1996-12)



REF	OEM
REC69W-82575-00	69W-82575-00



REF	OEM
PAF4-01090401	682-82556-00

**new**



REF	OEM
REC66T-82575-01	66T-82575-01

 E40X  
 MLHZ  
 X  
 MH (2001+)



REF	OEM
REC65W-82575-01	65W-82575-01

 F2.5  
 T-F 6-8  
 F9.9 -F15  
 9.9F-M  
 F13.5  
 F25 (2002+)





REF	OEM
REC6G8-81870-00	6G8-81870-00

 F8-A (1986-99)  
 F9.9A M,E,B (1985-99)  
 9.9F (1995-2000)  
 9.9-15-8-6/C-M-D (1984-2002)



REF	OEM
REC6A0-82550-01	6A0-82550-01

 9.9D/15D (1985-93)  
 8N/JCEM (1984-96)  
 6CEM/6DEM (1984-96)





### KITS

Interruptor de encendido para todo tipo de motores fueraborda o intraborda

REF KIT	CUERDA WIRE CORDA CORDON	
REC40970	REC40990	1



### KITS

Emergency and stop switch for inboard or outboards.

REF KIT	
GS11292	1



### KIT

Interruttore di accensione per tutti i tipi di motori fuoribordo o entro bordo.

REF KIT	CUERDA WIRE CORDA CORDON	
GS11290	GS11291	1



### KITS

Coupe circuit de sécurité pour moteur inboard ou hors-bord

REF	
GS11294	1



## STARTOR

REF	OEM	2T STROKES	4T STROKES
REC688-85510-10	688-85510-10 688-85510-11	✓	



75 (1988-96)  
85 (1989-96)  
90 (1984-90)



REF	OEM	2T STROKES	4T STROKES
REC6E5-85510-11	6E5-85510-11,10	✓	



115 (1984-89), (1991-98)  
130 (1988-89)  
150 (1984-89)



REF	OEM	2T STROKES	4T STROKES
REC688-85510-01	688-85510-00, 01	✓	



E75 BMHD, BMHDL (6925 - 692Y) (2003-15)  
75 A, AED, AEDL, AEM, AEHD, AET, AETL (692 - 692Y) (1997-15)  
75 A (692E) (2008)  
85 A, AE, AED, AEDL, AEDX, AEHD, AET, AETX (688 - 688F) (1997-15)  
85 A (6886 - 6887) (2007-08)



REF	OEM	2T STROKES	4T STROKES
PAF25-05140000	65W-85510-10	✓	



F20 (1998-06)  
F25 (1998-09)  
T25/FT25 (2000-09)  
F30 (2001-09)  
F40 (2000-09)



REF	OEM	2T STROKES	4T STROKES
REC6G5-85510-11	6G5-85510-10	✓	



200 (1984-89)



REF	OEM	2T STROKES	4T STROKES
REC6H1-85510-00	6H1-85510-00	✓	



80A AE (1990-91)  
90 AEO AETO (1990-91)



REF	OEM	2T STROKES	4T STROKES
PAF20-05000200	6AH-85510-00	✓	



F9,9 (2009+)  
F13,5B (2007-09)  
F15C,E,M (2007+)  
F20B,M (2007+)



new



# TRIM, TILT & POWER TRIM

## INSTALACIÓN ELÉCTRICA

## WIRING HARNESS

## INSTALLAZIONE ELETTRICA

## INSTALLATION ELECTRIQUE

### KIT CONVERSIÓN

Sustituye de 2 a 3 cables.

### CONVERSION KIT

Converts 3-wire Tilt and Trim motors to 2-Wire design

### KIT CONVERSIONE

Sustituisce da 2 a 3 cavi.

FAISCEAU CONVERTISSEUR 3 A 2 FILS

REF	OEM
PH200-WH01	



## INTERRUPTOR POWER TRIM POWER TRIM SWITCH

REF	OEM
REC6R3-82563-01	6R3-82563-00 6R3-82563-01

100 - 250 HP

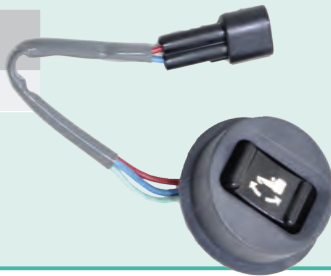

## INTERRUTTORE POWER TRIM

REF	OEM
PAE4-10040100W	703-82563-00, 01

Para mandos 703  
For controls 703  
Per comandi 703  
Pour 703

## INTERRUPTEUR DE TRIM

new



## TRIM COMPLETO BIDIRECCIONAL

## COMPLETE TRIM ASSEMBLY

## MOTORINO TRIM COMPLETO

## MOTEUR DE TRIM

REF	OEM	⚡	⚙️	⚙️	2T STROKES	4T STROKES
REC67C-43880-01	67C-43880-00, 01	12V	4	2		✓

T25 / FT25 (68V0 - 68V9) (2001-09)  
T25 / FT25 (6BL1 - 6BL8) (2009-15)  
F30 (69H1 - 69H9) (2001-09)  
F30 (6BT1 - 6BT8) (2009-15)  
F40 (67C0 - 67C8) (2001-09)  
F40 (6BG1 - 6BG8) (2009-15)



REF	OEM	⚡	⚙️	⚙️	2T STROKES	4T STROKES
PH200-T048	6H5-43880-00, 01, 02, 09	12V	4	2		✓

40-50HP (1984-94)



REF	OEM	⚡	⚙️	⚙️	2T STROKES	4T STROKES
PH200-T029	6H1-43880-02	12V	3	2	✓	

40HP (1994)  
50-90HP (1992-95)  
70-90 (1996)  
60-70-90 (1998)  
90HP (1992-02)



REF	OEM	⚡	⚙️	⚙️	2T STROKES	4T STROKES
PH200-T036	62Y-43880-01, 02 69W-43880-00, 01 CS3-43880-00	12V	3	2	✓	✓

40Y (2005-07)  
40V (2003)  
C40 (2002)  
F40 (2002)  
F50 (2002-07)  
FT50



REF	OEM	⚡	⚙️	⚙️	2T STROKES	4T STROKES
PH200-T035	62X-43880-00, 01, 09	12V	3	2	✓	✓

40V (1995-98)  
F45 (1995-99)  
50H (1995-98)  
F50 (1995-99)  
FT50 (1996-00)



REF	OEM	⚡	⚙️	⚙️	2T STROKES	4T STROKES
PH200-T041	6H1-43880-00	12V	3	2	✓	

60F (1987-91)  
70B (1987-91)  
75A (1990-91)  
80A (1987-91)  
85A (1990-91)  
90A (1987-91)



+ relés conversión | relay | rele | relais

REF	OEM	⚡	🔩	🔧	2T STROKES	4T STROKES
PH200-T044	67F-43880-00	12V	4	2		✓

F75 (2003-04)  
 F80 (1999-05)  
 F90 (2003-04)  
 F100 (1999-05)



REF	OEM	⚡	🔩	🔧	2T STROKES	4T STROKES
PAT40-10020500	65W-43880-00, 01	12V	4	2		✓

F20AE, AET, DET (1998-15)  
 F25A, AET, AMH, AW, EH, ELH, MHA, DMH, DET (1998-15)  
 F45AET/F50TJR (1999)  
 25J, JEO, ESH (1999)  
 30D, DETO, DMH (1999-10)  
 40X/E40X (1998-03)



REF	OEM	⚡	🔩	🔧	2T STROKES	4T STROKES
PH200-T068	6D8-43880-00, 01, 09	12V	4	2		✓

F75  
 F80  
 F100

EJE CORTO  
 SHORT SHAFT  
 ASSE CORTO  
 AXE COURT



REF	OEM	⚡	🔩	🔧	2T STROKES	4T STROKES
REC6D8-43880-09	6D8-43880-00, 09	12V	4	2		✓

F75TR, TLR, BET (2005)  
 F80AET, BET (2005-06)  
 F100AET, DET (2005-06)

EJE LARGO  
 LONG SHAFT  
 ASSE LUNGO  
 AXE LONG



REF	OEM	⚡	🔩	🔧	2T STROKES	4T STROKES
PH200-T069	69J-43880-00, 01 60V-43880-00	12V	3	2		✓

F200  
 F225 (2002+)  
 F250 (2005+)  
 Z300



REF	OEM	⚡	🔩	🔧	2T STROKES	4T STROKES
REC6AW-43880-02	6AW-43880-00, 01, 02	12V	2	2		✓

F300A (2008-11)  
 F350A (2008+)

**new**



REF	OEM	⚡	🔩	🔧	∅	2T STROKES	4T STROKES
PH200-T037	688-43880-11 6E5-43880-00, 01, 02	12V	3	3	68,3 mm		✓

60 90  
 70 115  
 75 150  
 80 200HP  
 85



14 mm

REF	OEM	⚡	🔩	🔧	2T STROKES	4T STROKES
PH200-T030	6G5-43880-00, 01, 02	12V	3	2		✓

115-200 (1987-95)  
 225 (1990-94)



REF	OEM	⚡	🔩	🔧	2T STROKES	4T STROKES
PH200-T057	6AE-43880-00, 01, 03, 04 68W-43880-03 67H-43880-00	12V	4	2		✓

225  
 250HP  
 115  
 225 (1997-02)



REF	OEM	⚡	🔩	🔧	2T STROKES	4T STROKES
PH200-T045	6C5-43880-00, 01	12V	3	1		✓

F40 (2006-10)  
 F60 (2006-10)  
 F50 (2005-10)  
 FT60 (2006-10)  
 40-50HP (1985-92)



REF	OEM	⚡	🔩	✂️	2T STROKES	4T STROKES
PH200-T050	61A-43880-00, 01	12V	3	4	✓	

🔧 225  
250HP



REF	OEM	⚡	🔩	✂️	2T STROKES	4T STROKES
REC63P-43880-22	63P-43880-10 63P-43880-11 63P-43880-12 63P-43880-22	12V	3	2		✓

🔧 F150A/B/C/D/F/G (2012+)  
F175A,C (2018+)  
F200B,C,F,G (2018+)



**POWER TRIM COMPLETO**      **COMPLETE POWER TRIM ASSEMBLY**

REF	OEM	2T STROKES	4T STROKES
REC18-6865	63P-43880-03-00 64E-43880-02-40 68V-43880-03-40	✓	✓

🔧 3 RAM  
115-225HP  
SHOWA SYSTEM



**MOTORINO POWER TRIM COMPLETO**      **POWER TRIM COMPLET**

REF	OEM	2T STROKES	4T STROKES
PAT40-10000000	65W-43800-02-4D 65W-43800-03-4D 65W-43800-21-4D 65W-43800-22-8D 65W-43800-23-8D 65W-43800-20-4D 65W-43800-01-4D 65W-43800-00-4D	✓	✓

🔧 F20 / F25  
E40 / 40X  
30D



REF	OEM	2T STROKES	4T STROKES
REC63P-43800-20	63P-4380003, 04, 06, 07, 20 64E-43880-02-40 68V-43880-03-40	✓	✓

🔧 115-220 HP (2003+)  
SHOWA SYSTEM



REF	OEM	2T STROKES	4T STROKES
PAF60-06000000	6C5-43800-11, 12		✓

🔧 F40/ F50/ F60 (2016+)



REF	OEM	2T STROKES	4T STROKES
REC6H1-43800-17-8D	6H1-43800-17-8D 6H1-43800-16-4D 6H1-43800-15-4D 6H1-43800-13-4D 6H1-43800-14-4D	✓	

🔧 50 - 90 HP





DESPIECE PISTÓN TRIM	PARTI PISTONE TRIM	PARTI PISTONE TRIM	PIECES VERIN DE TRIM
REF	OEM		UN.
REC64E-43821-05	64E-43821-00, -05 64E4382100, 64E4382105	TORNILLO CILINDRO EXTREMO	SCREW VITE VIS 2
REC48630-96J03	64E-43821-08, 09, 00 64E-43820-08, 09, 00 6AW-4380R-00	TAPÓN PARA SHOWA SYSTEM	CAP FOR SHOWA SYSTEM TAPPO PER SHOWA SYSTEM NEZ DE VERIN DE TRIM POUR SHOWA SYSTEM 2
1 REC48630-94900	67F-4380R-01, -00 67F-43811-00 61A-43821-00, -01, -09	TORNILLO CILINDRO EXTREMO	SCREW VITE VIS 2
REC48630-92J00	6EK-4380R-00 64E-43821-05 63P-43811-20, -10 64E-43811-02 61A-43811-00 6AW-4380R-01	TAPÓN PARA SHOWA SYSTEM	CAP FOR SHOWA SYSTEM TAPPO PER SHOWA SYSTEM NEZ DE VERIN DE TRIM POUR SHOWA SYSTEM 2
2 REC64E-43822-00	64E-43822-00	SELLO	SEAL OIL PARAOLIO JOINT TORIQUE 2
3 REC64E-4384J-00	64E-4384J-00	SELLO	SEAL OIL PARAOLIO JOINT TORIQUE 2
4 REC6G5-43864-00	6G5-43864-00	SELLO	SEAL OIL PARAOLIO JOINT TORIQUE 2

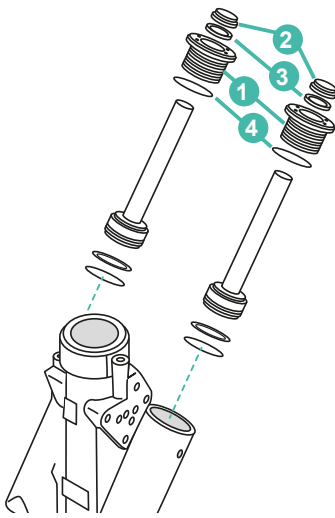

REF	OEM
REC48630-94900	67F-4380R-01, -00 67F-43811-00 61A-43821-00, -01, -09

**new**

- F75B/T (2005)
- F80A/B/T (1999-18)
- F100A/C/D (1999-18)
- F200, F225, F250 (2002-12)
- Z200, Z300 (2003-12)
- 250G (2006-10)
- F300 (2011-12)

REF	OEM
REC48630-92J00	6EK-4380R-00 64E-43821-05 63P-43811-20, -10 64E-43811-02 61A-43811-00 6AW-4380R-01

**new**

REF	OEM
REC64E-43821-05	64E-43821-00 64E-43821-05 64E4382100 64E4382105

**new**

REF	OEM
REC48630-96J03	64E-43821-08, 09, 00 64E-43820-08, 09, 00 6AW-4380R-00

**new**

- 100 - 300 HP
- F300, F350 (V8) (2008-12)

### EXTRACTOR TAPONES DE TRIM / TRIM PLUGS EXTRACTOR

REF	RECTOOLTRIM1 + RECTOOLTRIM2 + RECTOOLTRIM 3
RECTOOLTRIM1	1/2" + RECPIN4 + RECPIN4.5 38 mm
RECTOOLTRIM2	1/2" + RECPIN4 + RECPIN4.5 32 mm
RECTOOLTRIM3	1/2" + RECPIN6 35 mm

### ESTRATTORE PER TAPPI DI TRIM / KIT EXTRACTEUR

TRIM PISTON	TILT PISTON	RECTOOLTRIM1	F25 - F40
RECTOOLTRIM2	RECTOOLTRIM3	F115 (2000-14)	
RECTOOLTRIM2	RECTOOLTRIM3	F150 (2004-10)	
RECTOOLTRIM2	RECTOOLTRIM1	F150 (2011+)	
RECTOOLTRIM2	RECTOOLTRIM3	F175 - F200 (2.8L)	
RECTOOLTRIM1	RECTOOLTRIM1	F200 - F250 (3.3L)	
RECTOOLTRIM1	RECTOOLTRIM1	F225 - F300 (4.2L)	
RECTOOLTRIM2	RECTOOLTRIM3	F350	
RECTOOLTRIM2		F425	
RECTOOLTRIM2		55-90 (2-Stroke) (1994+)	
RECTOOLTRIM2	RECTOOLTRIM3	115-200 + VMAX	
RECTOOLTRIM1	RECTOOLTRIM1	225 (2-Stroke)	

**new**

### KITS DE RECAMBIO

Los pines de repuesto no tienen garantía.

REF	
RECPIN4	3 PIN x 4 mm
RECPIN4.5	3 PIN x 4.5 mm
RECPIN6	3 PIN x 6 mm

### SPARE KITS

Replacement pins are not guaranteed.

### KIT DI RICAMBIO

I perni di ricambio non sono garantiti.

### KIT DE RECHANGE

Les pines de remplacement ne sont pas garanties



# SISTEMA DE GOBIERNO STEERING SYSTEM

# SISTEMA DI GUIDA SYSTÈME DE DIRECTION

## MANDOS DE CONTROL

## ENGINE CONTROLS

## COMANDI DI CONTROLLO

## BOITIER DE COMMANDE

### MANDO LATERAL (703) PUSH TO OPEN

### SIDE CONTROL (703) PUSH TO OPEN

### COMANDO LATERALE (703) PUSH TO OPEN

### BOITIER LATERAL (703) PUSH TO OPEN

Conector de 7 pins. Sin PowerTrim  
Para motores fueraborda Yamaha de 9,9  
Electric a 30 Hp. Leva para aceleración en  
punto muerto. Utiliza cables 33-C

Connector 7 pins. Without PowerTrim  
For outboard engines Yamaha 9,9 Electric to  
30 Hp. Lever for neutral engine warm-up.  
For 33-C cables

Conettore da 7 pins. Sin PowerTrim  
Per motori fuoribordo Yamaha da 9,9  
Electric a 30 Hp. Leva per accelerare in un  
punto morto. Utilizza cavi 33-C.

Connecteur 7 broches. Sans Trim. Pour  
moteur hors-bord Yamaha de 9.9  
électrique à 30cv. Utilise des câbles 33C.

REF	OEM	2T STROKES	4T STROKES	
REC703-48230-14 PAF15-13000000W	703-48230-10			
	703-48230-11			
	703-48230-12			
	703-48230-13			
	703-48230-14			
	703-48230-15	9.9 - 70 HP (1986+)	✓	✓
	703-48230-16			
	703-48230-17			
	703-48230-18			
	703-48230-1A			
	703-48230-20			
703-48230-21				



**RECmar®**

Conector de 10 pins. Con PowerTrim  
Para motores fueraborda Yamaha de 40  
a 250 Hp. Leva para aceleración en punto  
muerto. Con interruptor y cableado de  
Power Trim. Utiliza cables 33-C

Connector 10 pins. With PowerTrim  
Dual function, single lever control, For  
outboard Yamaha 40 to 250 Hp. With power  
trim switch and wires. For 33-C cables.

Conettore da 10 pins. Con PowerTrim  
Per motori fuoribordo Yamaha da 40 a 250  
Hp. Leva per accelerare in un punto morto.  
Con interruttore e cablaggio di Power Trim.  
Utilizza cavi 33-C.

Connecteur 10 broches. Avec Trim  
interrupteur et faisceau. Boitier pour  
moteur hors-bord Yamaha de 40 à 250cv.  
Lever pour se mettre au point mort. Utilise  
des câbles 33C.

REF	OEM	2T STROKES	4T STROKES	
REC703-48205-16 PAT85-08010000W	703-48205-10			
	703-48205-11			
	703-48205-12			
	703-48205-13			
	703-48205-14			
	703-48205-15	8 - 300 HP (1984+)	✓	✓
	703-48205-16			
	703-48205-17			
	703-48205-18			
	703-48205-1A			
	703-48205-1B			
703-48205-20				
703-48205-21				



**RECmar®**



### MANDO LATERAL PULL TO OPEN

### SIDE CONTROL PULL TO OPEN

### COMANDO LATERALE PULL TO OPEN

### BOITIER LATERAL PULL TO OPEN

REF  
PAF40-13000000E1



new

YAMAHA

RECAMBIOS  
MARINOS

**PUSH TO OPEN**

REF	OEM
PAF15-13000500W	703-48261-01



*new*

**PULL TO OPEN**

REF	OEM
PAT20-13000500W	703-48861-11



*new*

MANDO LATERAL	SIDE CONTROL	COMANDO LATERALE	BOITIER LATERAL				
<p>Mando a distancia de palanca con doble función (acelerador y cambio). Para motores intraborda e intra-fueraborda. Montaje lateral superpuesto. Utiliza cables 33-C.</p> <table border="1"> <thead> <tr> <th>REF</th> <th>OEM</th> </tr> </thead> <tbody> <tr> <td>GS40015</td> <td>YMD-RCBOX-00-10</td> </tr> </tbody> </table> <p><b>GOLDENSHIP</b></p> 	REF	OEM	GS40015	YMD-RCBOX-00-10	<p>Dual function, single lever control, For virtually all stern drive, outboard and inboard engines. Push button for neutral engine warm-up. For 33-C cables.</p> 	<p>Comando a distanza di leve con doppia funzione acceleratore e cambio. Per motori entro-bordo e entro-fuoribordo. Montaggio laterale sovrapposto. Utilizza cavi 33-C.</p>	<p>Boitier mono levier bi-fonction accélérateur et inverseur pour moteur inboard et hors-bord. Bouton poussoir pour se mettre au point mort. Utilise des câbles 33C.</p>
REF	OEM						
GS40015	YMD-RCBOX-00-10						

MANDO PARA CONSOLA	CONSOLE CONTROL	COMANDO PER CONSOLLA	BOITIER POUR CONSOLE																																																															
<table border="1"> <thead> <tr> <th>REF</th> <th>YAMAHA 704</th> <th>TRIM</th> </tr> </thead> <tbody> <tr><td></td><td>704-48205-R0</td><td></td></tr> <tr><td></td><td>704-48205-P1</td><td></td></tr> <tr><td></td><td>704-48205-B1</td><td></td></tr> <tr><td></td><td>704-48205-B0</td><td></td></tr> <tr><td></td><td>704-48205-R0</td><td></td></tr> <tr><td>REC704-48205-R0</td><td>704-48205-14</td><td>✓</td></tr> <tr><td></td><td>704-48205-11</td><td></td></tr> <tr><td></td><td>704-48205-12</td><td></td></tr> <tr><td></td><td>704-48205-13</td><td></td></tr> <tr><td></td><td>704-48205-15</td><td></td></tr> <tr><td></td><td>704-48205-P0</td><td></td></tr> </tbody> </table> <p><b>RECMAR</b></p> 	REF	YAMAHA 704	TRIM		704-48205-R0			704-48205-P1			704-48205-B1			704-48205-B0			704-48205-R0		REC704-48205-R0	704-48205-14	✓		704-48205-11			704-48205-12			704-48205-13			704-48205-15			704-48205-P0		<table border="1"> <thead> <tr> <th>REF</th> <th>YAMAHA 704</th> <th>TRIM</th> </tr> </thead> <tbody> <tr><td></td><td>704-48207-R0</td><td></td></tr> <tr><td></td><td>704-48207-P1</td><td></td></tr> <tr><td></td><td>704-48207-39</td><td></td></tr> <tr><td>REC704-48207-R0</td><td>704-48207-31</td><td>✓</td></tr> <tr><td></td><td>704-48207-30</td><td></td></tr> <tr><td></td><td>704-48207-20</td><td></td></tr> <tr><td></td><td>704-48207-21</td><td></td></tr> <tr><td></td><td>704-48207-22</td><td></td></tr> </tbody> </table> <p><b>RECMAR</b></p> 	REF	YAMAHA 704	TRIM		704-48207-R0			704-48207-P1			704-48207-39		REC704-48207-R0	704-48207-31	✓		704-48207-30			704-48207-20			704-48207-21			704-48207-22		<p><i>new</i></p>	
REF	YAMAHA 704	TRIM																																																																
	704-48205-R0																																																																	
	704-48205-P1																																																																	
	704-48205-B1																																																																	
	704-48205-B0																																																																	
	704-48205-R0																																																																	
REC704-48205-R0	704-48205-14	✓																																																																
	704-48205-11																																																																	
	704-48205-12																																																																	
	704-48205-13																																																																	
	704-48205-15																																																																	
	704-48205-P0																																																																	
REF	YAMAHA 704	TRIM																																																																
	704-48207-R0																																																																	
	704-48207-P1																																																																	
	704-48207-39																																																																	
REC704-48207-R0	704-48207-31	✓																																																																
	704-48207-30																																																																	
	704-48207-20																																																																	
	704-48207-21																																																																	
	704-48207-22																																																																	

CONECTORES DE CABLES	CABLE CONNECTOR	CAVO CONNETTORE	EMBOUT DE CABLE								
<table border="1"> <thead> <tr> <th>REF</th> <th>OEM</th> </tr> </thead> <tbody> <tr> <td>REC663-48344-00</td> <td>663-48344-00</td> </tr> </tbody> </table>  <p>6&gt;115HP</p>	REF	OEM	REC663-48344-00	663-48344-00		<table border="1"> <thead> <tr> <th>REF</th> <th>OEM</th> </tr> </thead> <tbody> <tr> <td>PAF25-07000007W</td> <td>703-48345-01</td> </tr> </tbody> </table>  <p>6&gt;115HP</p>	REF	OEM	PAF25-07000007W	703-48345-01	
REF	OEM										
REC663-48344-00	663-48344-00										
REF	OEM										
PAF25-07000007W	703-48345-01										

## INTERRUPTORES PARA MANDOS

## SWITCHES FOR ENGINE CONTROLS

## INTERRUTTORI PER CONTROLLO

## INTERRUPTEUR DE CONTRÔLE

### INTERRUPTOR POWER TRIM (703)

### POWER TRIM SWITCH (703)

### INTERRUTTORE POWER TRIM (703)

### COMMUTATEUR DE TRIM (703)

REF	OEM
PAE4-10040100W	703-82563-00
	703-82563-01
	703-82563-02

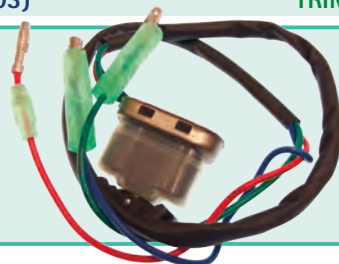

new

### INTERRUPTOR PANEL SIMPLE (704)

### SWITCH (704)

### INTERRUTTORE PANNELLO SIMPLE (704)

### TABLEAU DE COMMANDE SIMPLE (704)

REF	OEM
REC704-82570-12	704-82570-12
	704-82570-11
	704-82570-10
	704-82570-08
	6E5-82570-05

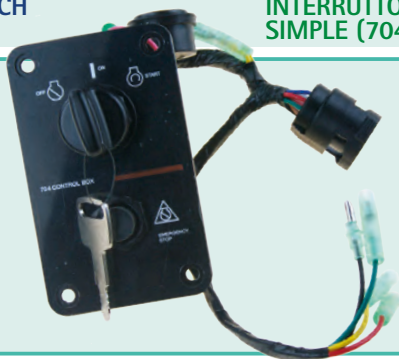

new

### INTERRUPTOR PANEL COMPLETO O DOBLE ESTACIÓN

### PANEL TWIN STATION

### PANNELLO DOPPIA STAZIONE

### BOITIER DE DEMARRAGE 2 MOTEURS

REF	OEM
REC6K1-82570-13	6K1-82570-13
	6K1-82570-12
	6K1-82570-11
	6K1-82570-10
	6K1-82570-08
	6K1-82570-07
	6K1-82570-06
	6K1-82570-05
	6K1-82570-04
	6K1-82570-03
	6K1-82570-02
	6K1-82570-00

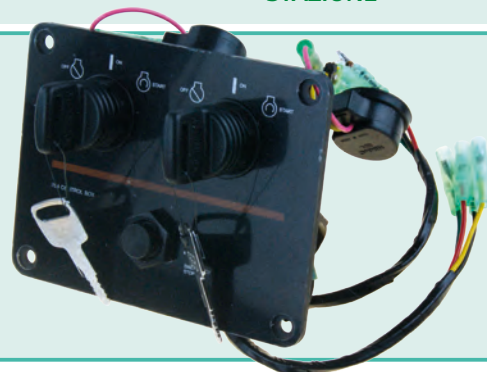

new

## ARNÉS

## ARNES

## CAVI

## FAISCEAU ELECTRIQUE

### EXTENSIÓN DE ARNÉS (703/704)

### ARNES EXTENSION (703/704)

### ESTENSIONE (703/704)

### RALLONGE FAISCEAU (703/704)

REF	OEM		PINS
REC688-8258A	688-8258A-10	2 m	10
REC688-8258A-30	688-8258A-30	3 m	10



new

### ARNÉS COMPLETO (703)

### ARNES ASSY (703)

### CAVO CONTROLLO COMPLETO (703)

### FAISCEAU ELECTRIQUE BOITIER CDE (703)

REF	OEM		PIN
PAF15-13000100W	688-82586-21	5 m	7
PAT85-08010100	688-8258A-20	5 m	10



PAF15-13000100W



PAT85-0801010

new

**COMPONENTES (703)**

**COMPONENTS (703)**

**COMPONENTI (703)**

**COMPOSANT (703)**

**ESPACIADOR**

**PLATE CONTROL BOX**

**DISTANZIALE**

**PLAQUE BOITIER DE COMMANDE**

REF	OEM
PAF15-11000002W	703-48293-10



**new**

**PALANCA ACELERADOR**

**THROTTLE HANDLE INCHING**

**LEVA ACCELERATORE**

**POIGNEE DE PAPILLON**

REF	OEM
PAF15-13020007W	703-48152-00



**new**

**CABLE DE ACELERADOR**

**THROTTLE CABLE**

**CAVO ACCELERATORE**

**CÂBLE D'ACCELERATEUR**

REF	OEM
REC6E0-26301-01	6E0-26301-01



4AC/A/AS  
5C/CS/CMH



REF	OEM
REC6B4-26301-00	6B4-26301-00



E15D  
E9.9D



REF	OEM
REC677-26301-02	677-26301-02



E8D  
E8DMH



REF	OEM
REC61N-26311-00	61N-26311-00



25B/BM/V  
30G/E30H



REF	OEM
REC6L2-26301-00	6L2-26301-00



9.9F/FM  
13.5AM  
15F/FM  
20D/M  
25N/NE/NW/D/M



REF	OEM
REC6F5-26311-00	6F5-26311-00



E40G/J  
40G/J



REF	OEM
REC66T-26301-00	66T-26301-00



40X/E40X



REF	OEM
REC692-26301-03	692-26301-00, 01,02,03



55B (1992-00)  
75A (1992-00)  
85A (1995-98)  
E75B (2003-16)  
E48C (2003)  
E60H (2001+)  
E55C (2003-16)  
F40J (2016+)



**new**



**PLACA CERRADURA SELECTOR**

**BLOCK CONTROL HANDLE**

**PLACCA SERRATURA SELETTORE**

**CALE POIGNEE DE CONTROLE**

REF	OEM
PAF15-13010010W	703-48245-00



new

**RUEDA ACELERACION**

**LEVER THROTTLE**

**RUOTA ACCELERAZIONE**

**ROUE D'ACCELERATEUR**

REF	OEM
REC663-42138-00	663-42138-00

- 55B/BET
- E55
- E60
- 75A5
- 85AE



**CABLES DE CONTROL**

**CONTROL CABLES**

**CAVI COMANDO**

**CÂBLES DE COMMANDE**

Recorrido trabajo: 76 mm.  
Rosca 10-32"

Travel 3"  
Threaded 10-32"

Estensione 76 mm  
Filetto 10-32"

Course: 76 mm.  
Fil 10-32

REF	RO	
PRE3300C05	YMM-21005-00-00	5' / 1,50 m
PRE3300C06	YMM-21006-C8-00	6' / 1,80 m
PRE3300C07	YMM-21007-C8-00	7' / 2,10 m
PRE3300C08	YMM-21008-C8-00	8' / 2,45 m
PRE3300C09	YMM-21009-C8-00	9' / 2,75 m
PRE3300C10	YMM-21010-C8-00	10' / 3,05 m
PRE3300C11	YMM-21011-C8-00	11' / 3,35 m
PRE3300C12	YMM-21012-C8-00	12' / 3,65 m
PRE3300C13	YMM-21013-C8-00	13' / 3,95 m
PRE3300C14	YMM-21014-C8-00	14' / 4,25 m
PRE3300C15	YMM-21015-C8-00	15' / 4,60 m
PRE3300C16	YMM-21016-C8-00	16' / 4,90 m
PRE3300C17	YMM-21017-C8-00	17' / 5,20 m
PRE3300C18	YMM-21018-C8-00	18' / 5,50 m
PRE3300C19	YMM-21019-C8-00	19' / 5,80 m
PRE3300C20	YMM-21020-C8-00	20' / 6,10 m
PRE3300C21	YMM-21021-C8-00	21' / 6,40 m
PRE3300C22	YMM-21022-C8-00	22' / 6,70 m
PRE3300C23	YMM-21023-C8-00	23' / 7,00 m
PRE3300C24	YMM-21024-C8-00	24' / 7,30 m
PRE3300C25	YMM-21025-C8-00	25' / 7,60 m
PRE3300C26	YMM-21026-C8-00	26' / 7,90 m
PRE3300C27	YMM-21027-C8-00	27' / 8,25 m
PRE3300C28	YMM-21028-C8-00	28' / 8,55 m
PRE3300C29	YMM-21029-C8-00	29' / 8,85 m
PRE3300C30	YMM-21030-C8-00	30' / 9,15 m

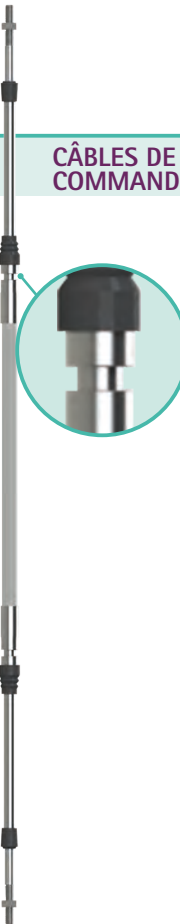
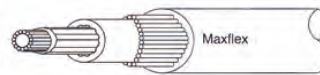
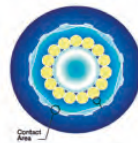

maxflex



**VARILLA DE ENLACE**

**LINK ROD ASSY**

**LEVA COLLEGAMENTO**

**BARRE D'ACCOUPEMENT COMPLETE**

REF	OEM
PAF25-07000300W	65W-61350-00

- F20A
- F25A
- FT25B
- F30A
- F40B/C/D
- F50F/H
- F60A/C/F
- FT50G/J
- FT60B/D/G
- F70A/40X



REF	OEM
PAF20-07000100W	63AH-61350-00

- F15C
- F20B



REF	OEM
GS41084	6E5-61301-00 6E5-61301-01



REF	OEM
PAF15-11020000W	63V-61350-00

- 9.9F
- 15F
- F9.9C
- FT9.9D
- F15A



MANETA ACELERADOR	LEVER, THROTTLE	LEVA COLLEGAMENTO	LEVIER DE COMMANDE								
<table border="1"> <thead> <tr> <th>REF</th> <th>OEM</th> </tr> </thead> <tbody> <tr> <td>PAF4-01090100</td> <td>6G1-42138-00,01 6EG-G2138-00</td> </tr> </tbody> </table> 	REF	OEM	PAF4-01090100	6G1-42138-00,01 6EG-G2138-00		<table border="1"> <thead> <tr> <th>REF</th> <th>OEM</th> </tr> </thead> <tbody> <tr> <td>PAF15-01030100</td> <td>65W-42138-00</td> </tr> </tbody> </table> 	REF	OEM	PAF15-01030100	65W-42138-00	
REF	OEM										
PAF4-01090100	6G1-42138-00,01 6EG-G2138-00										
REF	OEM										
PAF15-01030100	65W-42138-00										

### BRACKET

BRACKET ESTRIBOR	RIGHT BRACKET ASSY	BRACKET TRIBORDO	ETRIER DROIT																				
<table border="1"> <thead> <tr> <th>REF</th> <th>OEM</th> <th>2T STROKES</th> <th>4T STROKES</th> </tr> </thead> <tbody> <tr> <td rowspan="5">PAF15-01010200</td> <td>63V-43112-00-4D</td> <td></td> <td></td> </tr> <tr> <td>63V-43112-01-4D</td> <td>✓</td> <td>✓</td> </tr> <tr> <td>63V-W4311-00-4D</td> <td></td> <td></td> </tr> <tr> <td>63V-W4311-03-4D</td> <td></td> <td></td> </tr> <tr> <td>63V-WS431-B6-8D</td> <td></td> <td></td> </tr> </tbody> </table> 	REF	OEM	2T STROKES	4T STROKES	PAF15-01010200	63V-43112-00-4D			63V-43112-01-4D	✓	✓	63V-W4311-00-4D			63V-W4311-03-4D			63V-WS431-B6-8D					
REF	OEM	2T STROKES	4T STROKES																				
PAF15-01010200	63V-43112-00-4D																						
	63V-43112-01-4D	✓	✓																				
	63V-W4311-00-4D																						
	63V-W4311-03-4D																						
	63V-WS431-B6-8D																						

BRACKET BABOR	LEFT BRACKET ASSY	BRACKET BABORDO	ETRIER GAUCHE														
<table border="1"> <thead> <tr> <th>REF</th> <th>OEM</th> <th>2T STROKES</th> <th>4T STROKES</th> </tr> </thead> <tbody> <tr> <td rowspan="3">PAF15-01010100</td> <td>63V-43111-00-4D</td> <td></td> <td></td> </tr> <tr> <td>63V-43111-01-4D</td> <td>✓</td> <td>✓</td> </tr> <tr> <td>63V-43111-A2-4D</td> <td></td> <td></td> </tr> </tbody> </table> 	REF	OEM	2T STROKES	4T STROKES	PAF15-01010100	63V-43111-00-4D			63V-43111-01-4D	✓	✓	63V-43111-A2-4D					
REF	OEM	2T STROKES	4T STROKES														
PAF15-01010100	63V-43111-00-4D																
	63V-43111-01-4D	✓	✓														
	63V-43111-A2-4D																

SOPORTE GIRATORIO	BRACKET, ROTARY	SUPPORTO GIRATORIO	SUPPORT TOURNANT														
<table border="1"> <thead> <tr> <th>REF</th> <th>OEM</th> <th>2T STROKES</th> <th>4T STROKES</th> </tr> </thead> <tbody> <tr> <td rowspan="3">PAF15-01010301S</td> <td>63V-43311-00-4D</td> <td></td> <td></td> </tr> <tr> <td>63V-43311-01-4D</td> <td>✓</td> <td>✓</td> </tr> <tr> <td>99999-03116</td> <td></td> <td></td> </tr> </tbody> </table> 	REF	OEM	2T STROKES	4T STROKES	PAF15-01010301S	63V-43311-00-4D			63V-43311-01-4D	✓	✓	99999-03116					
REF	OEM	2T STROKES	4T STROKES														
PAF15-01010301S	63V-43311-00-4D																
	63V-43311-01-4D	✓	✓														
	99999-03116																

SOPORTE BARRA DE DIRECCION	BOLT, CLAMP BRACKET	SUPPORTO BARRA DIREZIONE	TUBE SUPPORT CABLE DE DIRECTION														
<table border="1"> <thead> <tr> <th>REF</th> <th>OEM</th> <th>2T STROKES</th> <th>4T STROKES</th> </tr> </thead> <tbody> <tr> <td rowspan="3">PAF15-01010001</td> <td>63V-43131-00</td> <td></td> <td></td> </tr> <tr> <td>63V-43131-10</td> <td>✓</td> <td>✓</td> </tr> <tr> <td>63v-43131-01</td> <td></td> <td></td> </tr> </tbody> </table> 	REF	OEM	2T STROKES	4T STROKES	PAF15-01010001	63V-43131-00			63V-43131-10	✓	✓	63v-43131-01					
REF	OEM	2T STROKES	4T STROKES														
PAF15-01010001	63V-43131-00																
	63V-43131-10	✓	✓														
	63v-43131-01																

TUERCA AUTOBLOCANTE	NUT, SELF-LOCKING	BULLONE AUTOBLOCCANTE	ECROU AUTO VERROUILLABLE						
<table border="1"> <thead> <tr> <th>REF</th> <th>OEM</th> </tr> </thead> <tbody> <tr> <td rowspan="3">PAF15-01010007</td> <td>63V-43145-00</td> </tr> <tr> <td>90185-22043</td> </tr> <tr> <td>90185-22M11</td> </tr> </tbody> </table> 	REF	OEM	PAF15-01010007	63V-43145-00	90185-22043	90185-22M11			
REF	OEM								
PAF15-01010007	63V-43145-00								
	90185-22043								
	90185-22M11								

**RETÉN INFERIOR DEL BRACKET**      **BRACKET OIL SEAL**      **ANELLO BRACCETTO**      **JOINT INFERIEUR DU SUPPORT**

REF	OEM	2T STROKES	4T STROKES
REC93109-44M00	93109-44M00	✓	

40 HP



**new**

**SOPORTE INFERIOR**      **SHELL, MOUNT DAMPER**      **SUPPORTO INFERIORE**      **SUPPORT SILENT BLOCK**

REF	OEM
PAF15-00000001	66M-44551-00-4D 63V-45551-00-4D

9.9  
13.5  
15



**new**

**VARILLA DE BASCULACIÓN**      **TILT ROD**      **ASTA BASCULANTE**      **BARRE DE TILT**

REF	OEM
REC676-43160-02	676-43160-00 676-43160-01 676-43160-02

40 - 55 HP

REF	OEM
REC688-43160-01	688-43160-01

40 - 90 HP





**new**

**CIRCLIP**      **CIRCLIP**      **CIRCLIP**      **CIRCLIP**

REF	OEM
PAGB/T896-9	93430-10M00 99080-10600

6L5



**new**

**CONECTOR**      **CONNECTOR**      **CONNETTORE**      **CONNECTEUR**

REF	OEM
REC682-41237-00	682-41237-00
REC682-41237-50	682-41237-50
REC663-85518-00	633-85518-00

REC682-41237-00      REC682-41237-50      REC663-85518-00





**new**

**EJE CONECTOR ACCELERADOR**      **THROTTLE SHAFT CONNECTOR**      **ASSE CONNETTORE ACCELERATORE**      **TIGE DE CONNEXION ACCELERATEUR**

REF	OEM
REC688-41211-01	688-41211-00 688-41211-01



**new**

ENGRASADOR INOX 316  
M6

OILER M6

INGRASSATORE

GRAISSEUR M6 INOX 316

REF	OEM
PAJB/T9740.1-M6	93700-06M03



new

BUJES

BUSHINGS

BOCCOLE

BAGUES

REF	OEM
PAF15-01010302	90386-22M15
REC90386-25M31	90386-25M31
PAF15-01000004	90386-30048
PAF25-01000004	90386-44M03
PAF25-01000001	90386-52M02
REC90386-30M77	90386-30M77



PAF15-01010302



REC90386-25M31



PAF15-01000004



PAF25-01000004



PAF25-01000001



REC90386-30M77



REF	OEM	
REC90386-22M13	90386-22M13	NYLON
PAT85-01010203	90386-10M16	NYLON
PAF25-01010002	90386-22M15	NYLON
PAT85-01020005	90386-30M77	NYLON
PAT85-00000017	90386-18M35	NYLON
REC90386-18M63	90386-18M63	NYLON
REC90386-22M98	90386-22M98	NYLON
REC90381-20001	90381-20001	NYLON
REC90386-38M89	90386-38M89	NYLON
PAF15-01000001	65F-42537-00	NYLON
PAF25-03000007	90387-06M69	METAL



REC90386-22M13



PAT85-01010203



PAF25-01010002



PAT85-01020005



REC90386-18M63



REC90386-22M98



REC90381-20001



REC90386-38M89



PAT85-00000017



PAF15-01000001



PAF25-03000007

new

COLLAR

WASHER, BELOW

COLLARE

CALLE

REF	OEM
PAF15-01000006	90386-30M60
PAT85-01020003	90386-30M78



PAF15-01000006



PAT85-01020003

new



## MANDO ACELERADOR

## STEERING HANDLE ASSY

## MANIGLIA

## POIGNEE DE DIRECTION

REF	OEM
PAF4-01090300	68D-G2177-10 6EE-G2177-00



REF	OEM
REC6N0-G2177-00	6N0-G2177-00



## EJE DE CAMBIO

## HANDLE GEAR SHIFT ASSY

## LEVERAGGIO

## COMMANDE D'INVERSION

REF	OEM
REC688-44120-12	688-44120-11 688-44120-12



REF	OEM
REC692-44120-22	692-44120-21 692-44120-22



REF	OEM
REC688-44120-22	688-44120-22



## MANETAS Y FIJACIONES

## STARTER HANDLE AND FIXINGS

## MANIGLIE E CHIUSURE

## POIGNEE LANCEUR ET DE SERRAGE

REF	OEM
REC6L8-G3118-01	6L8-G3118-01

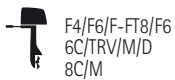

REF	OEM
REC648-44146-00	648-44146-00

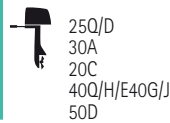

REF	OEM
REC99999-02808	99999-02808



REF	OEM
REC689-15755-00	689-15755-00



REF	OEM
REC6E0-43118-01	6E0-43118-00 6E0-43118-01



REF	OEM
REC650-44147-00	650-44147-00



REF	OEM
REC663-43118-01-4D	663-43118-01-4D

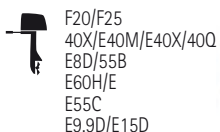

SILENBLOCK

SILENBLOCK

SILENBLOCK

SILENT BLOC

REF	OEM
REC63V-44514-01-CA	63V-44514-01-CA

 9.9F/FM/MS  
 13.5AMH  
 15F/FM/MS





REF	OEM
REC66T-44514-00-4D	66T-44514-00-4D

 40X  
 E40X/M



REF	OEM
REC670-44514-00	670-44514-00

 55B  
 E55CMH



REF	OEM
PAF15-00000002	682-44555-30

 6 HP  
 8 HP  
 9.9 HP  
 15 HP

**new**



REF	OEM
REC670-44555-00-94	62Y-44555-00

 E48CM  
 E55CM



REF	OEM
PAF15-00000003	66M-44557-00

 9.9 HP  
 13.5 HP  
 15 HP

**new**



REF	OEM
REC679-44514-00-94	679-44514-00-94

 40QE/QWC/G/J  
 E40G/J



REF	OEM
PAF15-02010000	66M-44514-00-4D

 9.9 HP  
 13.5 HP  
 15 HP

**new**



REF	OEM
REC682-44514-01-94	682-44514-01-94

 E9.9DMH  
 E15DMH



REF	OEM
REC663-44551-02-8D	663-44551-02-8D

 F50DETL  
 75CETO  
 90AETO/TRH



REF	OEM
REC688-44514-00	688-44514-00

 E60HMHD  
 70BETO  
 75CETO  
 90AETO



REF	OEM
REC676-44518-00	676-44518-00

 E40G/J  
 40G/J  
 40G



REF	OEM
REC688-44555-00	688-44555-00

 60FE/FET  
 70CE/ETN  
 E75B  
 80A  
 85A



# SISTEMA DE REFRIGERACIÓN COOLING SYSTEM

# SISTEMA DI RAFFREDDAMENTO SYSTÈME DE REFROIDISSEMENT

## LÍQUIDO INHIBIDOR DE LA CORROSIÓN

## SALT OFF

Diseñado especialmente para eliminar sedimentos de sal de cualquier superficie pintada, de metal, fibra de vidrio, vinilo, caucho, cristal o plástico. Es el método más eficaz para proteger los motores, los aparos de pesca... Genera una capa de polímeros que evita futuras sedimentaciones.

It is specifically formulated to quickly and effectively remove salt deposits from metal, fiberglass, plastic or painted surfaces. It contains special polymers that bond to the treated surface to help prevent the formation of future deposits.

## LIQUIDO INIBITORE DELLA CORROSIONE

## SALT OFF

Appositamente progettato per rimuovere depositi di sale da qualsiasi superficie verniciata, metallo, fibra di vetro, vinile, gomma, vetro o plastica. È il metodo più efficace per proteggere motori, attrezzi da pesca... Genera uno strato di polimeri che impedisce la futura sedimentazione.

La protection SALT OFF est formulé pour éliminer les dépôts de sel sur toutes les surfaces marines. Utilisable pour le rinçage des moteurs hors bord et inboard et les embases. Il laisse un film de protection spécial pour prévenir des attaques futures du sel.

new



REF  
STA94100

Star brite



REF	Image	Volume
STA93900		3,78 L
STA93922		650 ml
STA93932		1 L

STA93900



STA93932



STA93922

## TERMOSTATO

## THERMOSTAT

## TERMOSTATO

## THERMOSTAT

### TERMOSTATO

### THERMOSTAT

### TERMOSTATO

### THERMOSTAT

REF	OEM	°C
REC6DA-12411-01	6DA-12411-01	60°



REF	OEM	°C
REC6FM-12411-00	6FM-12411-00	60°



REF	OEM	°C
REC6AH-12411-00	69M-12411-01	60°
	69M-12411-00	
	6AH-12411-00	



REF	OEM	°C
REC6E5-12411-02	6E5-12411-00	50
	6E5-12411-01	
	6E5-12411-02	



REF	OEM	°C
REC6D9-12411-00	6D9-12411-00	55°



**new**

REF	OEM	°C
REC6E5-12411-30	6E5-12411-30	50°
	6E5-12411-20	
	6E5-12411-10	



REF	OEM	°C
REC6CE-12411-00	6CE-12411-00	52°



**new**

REF	OEM	°C
PAF15-07000031	66M-12411-00	60°
	66M-12411-01	



REF	OEM	°C
REC6AW-12411-00	6AW-12411-00	60°



**new**

REF	OEM	°C
REC6H3-12411-10	6H3-12411-00	60°
	6H3-12411-01	
	6H3-12411-10	
	6H3-12411-11	



REF	OEM	°C
REC6FP-12411-00	6FP-12411-00	60°



**new**

REF	OEM	°C
REC67F-12411-01	67F-12411-00	60°
	67F-12411-01	



REF	OEM	°C
REC6F5-12411-03	6F5-12411-00	60°
	6F5-12411-01	
	6F5-12411-02	
	6F5-12411-03	



**new**

REF	OEM	°C
REC60V-12411-00	60V-12411-00	50°



GUÍA TERMOSTATO

THERMOSTAT GUIDE

GUIDA TERMOSTATO

GUIDE DES THERMOSTATS

	REF
3A/ 4A/ 5C/ 6C/ 8C/ 25N (-1993)/ 25NWO	REC6E5-12411-02
9.9F/ 15F/ 25N(1994+)/30D/ 40V/ 75C/ 90A/ 100A/ 115C/ 130B/ 150F/ 175D/ 200F/G/ 225D/G/ 250A/B/ Z150P/Q/ Z175G/ Z200N/P	REC6E5-12411-30
F2.5A/ F9.9H/ F13.5B/ F15C/ F20B,M	REC6AH-12411-00
9.9D/ 15D/ 20C/ 25D/ 40Q/ 55B	REC6F5-12411-03
F15C/F20D	REC6AH-12411-00
F25G	REC6FM-12411-00
50G/ 60F/ 70B	REC6H3-12411-10
F4A/B/ F5A/ F6A/C/ F8B/C/ F18D/ F9.9B/C/F/J/ FT9.9A/D/G/L/ F15A/ F25A/D/ FT25B/F/ F30A/B/ F40A/B/F/ F50A/F/H/ FT-50B/C/G/J/ F60A/C/F/ FT60B/D/G/ F70A/ F80A/ F100A(2000-)	PAF15-07000031

	REF
F80A/B/ F100A(01+)/ F100B/ F(L)150A/ F(L)200A/C/ F(L)225A/B/C/ F(L)250A/B	REC67F-12411-01
F100D	REC6D9-12411-00
F100F	REC6FP-12411-00
F(L)225F/ F(L)250D/ F(L)300B	REC6CE-12411-00
F(L)200F/ F(L)200G/ F175A	REC6DA-12411-01
F(L)300A/ F(L)350A	REC6AW-12411-00
F100B/ F(L)115A/ (L)2250D/F/ Z300A	REC60V-12411-00



JUNTAS TERMOSTATO

THERMOSTATO GASKETS

GUARNIZIONI TERMOSTATO

JOINTS DE THERMOSTAT

**new**

REF	OEM
REC63P-12414-00	63P-12414-00

F150A/B/D/F/T (2004+)

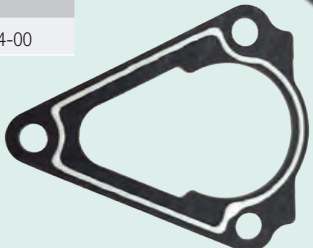

**new**

REF	OEM
PAF20-05000702	6AH-12414-00

F9.9 -F20 (New models)

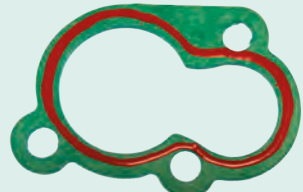

REF	OEM
PAF4-04000011	68D-E2414-A0

F2.5  
F4  
F5  
F6



REF	OEM
REC655-12414-A1	655-12414-A1

20C/CM  
E25A  
E25BMH  
25VE/VM/DE/D/B/BMH/BWH/HMH  
30G/GE/A  
E30HMH  
30HMH/HWH/HWL



REF	OEM
REC6G8-12414-A0	6G8-12414-A0

T8/T9.9  
F6/8/9.9  
FT8/9.9



REF	OEM
REC676-12414-A0	676-12414-A1

40X/E40X/E40MLH



REF	OEM
PAF15-07010022	62Y-12414-00
REC6H3-12414-A1	6H3-12414-A1

F9.9  
F60  
F30  
F13.5  
F70  
FT9.9  
T9.9TLR  
FT25  
FT50

FT60  
F15/20/25/40/45/50  
T50TLR  
T60TLR  
T25TLR



REF	OEM
REC6E9-12414-A1	6E9-12414-A1

40QE/QM/QEZ/QWC/GWH/JWH  
E40GMH/JMH



REF	OEM
REC682-12414-A1	682-12414-A1

9.9D/F/FMH/FEMH/MH/MSH  
15D  
E9.9DMH  
13.5AMH  
15F/FEMH/FMH/MSH/MH  
E15DMH



REF	OEM
REC663-12414-00	663-12414-A0

E48CMHS  
55B/BET/BE/BM  
E55CMH



REF	OEM
REC61A-12414-A0	61A-12414-A0

20DM/MSH  
25J/JETO/NEM/NWC/D/DM  
30D/DMH  
40V/VMH/VEO  
C40MLH/T  
50H/HM  
225C/CET/FETO/G  
250AET/B/TXR/G/GETO



REF	OEM
REC688-12414-A1	688-12414-A1

75CETO/AE  
E75B  
80AE/A  
85AE/A  
90AE/TLR  
100A/TLR  
115BE/B  
115A/AETO/CET  
130BETO/TLR  
150F/TXRA/FETO/C

Z150  
175D/DETO/DETO  
Z175  
225D/DETO  
VZ200  
Z200  
200AET/CETO/F/  
FETO/G/GETO



**CUBIERTAS TERMOSTATO**    **THERMOSTATO COVER**

REF	OEM	
REC6E9-12413-00-1S	6E9-12413-00-1S	REC6E9-12414-A1

E40/40J (2003+)



*new*

REF	OEM	
REC688-12413-00-1S	688-12413-00-1S	REC688-12414-A1



*new*

**COPERCHIO TERMOSTATO**    **COUVERCLE DE THERMOSTAT**

REF	OEM	
REC682-12413-00-1S	682-12413-00-1S 682-12413-00-9M	REC682-12414-A1

E40/40J (2003+)



*new*

**VÁLVULA ANTIPRESIÓN DE TERMOSTATO**

**THERMOSTAT, PRESSURE VALVE**

**VALVOLA ANTI-PRESSIONE DE TERMOSTATO**

**SOUPAPE DE PRESSION DE THERMOSTAT**

REF	OEM	O-RING	OEM
REC688-12416-00	688-12416-00	REC90480-20M05	90480-20M05

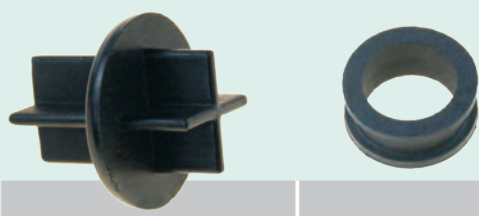

*new*

**RESORTE**

**SPRING**

**MOLLA**

**RESSORT**

REF	OEM
REC90501-16M11	90501-16M11

75 / 85 / 90A



*new*

**NIPLE**

**NIPPLE**

**NIPLE**

**TETINE**

REF	OEM
PAF15-05000009	6H3-44391-00 6H3-44391-01 6BL-44391-00



*new*

**JUNTAS TAPA, DE REFRIGERACIÓN**

**GASKET, EXHAUST INNER COVER**

**GUARNIZIONE COPERCHIO REFRIGERAZIONE**

**JOINT DE PLAQUE DE REFRIGERISSEMENT**

REF	OEM
REC6E0-41114-A1	6E0-41114-A1

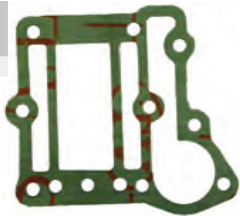

REF	OEM
REC6E0-41112-A1	6E0-41112-A1

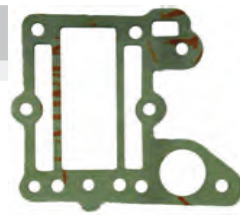

REF	OEM
REC6G1-41112-A1	6G1-41112-A1

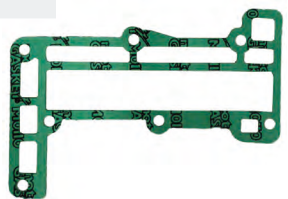

REF	OEM
REC6G1-41114-A0	6G1-41114-A0

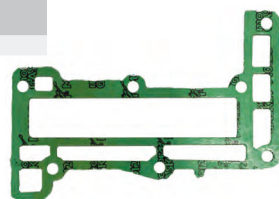

REF	OEM
REC6G1-11193-A1	6G1-11193-A1



REF	OEM
REC6G8-41112-02	6G8-41112-02

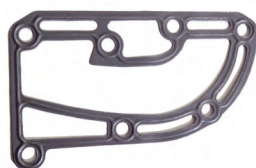

REF	OEM
REC6G8-41114-00	6G8-41114-00

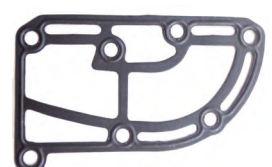

REF	OEM
REC677-41112-A0	677-41114-A0



REF	OEM
REC6B4-11193-A0	6B4-11193-A0

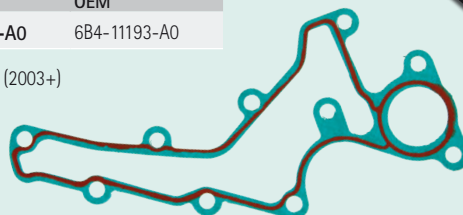
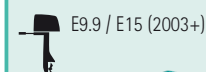

new

REF	OEM
REC682-41114-00	682-41114-A1



REF	OEM
REC682-41112-00	682-41112-A1



REF	OEM
PAF15-07010018	66M-41114-01



REF	OEM
REC63V-41112-A0	63V-41112-A0



REF	OEM
REC664-41114-A0	664-41114-A0

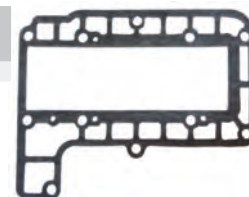

REF	OEM
REC6L2-41114-A1	6L2-41114-A1

 20D/M  
25N/M/D



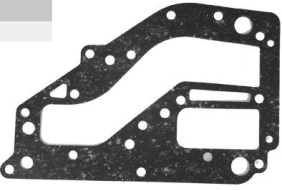

REF	OEM
REC6K8-41122-A1	6K8-41122-A1

 25VE/M/B/BMH  
E25A  
30HM/HW/G/GE  
E30HMH



REF	OEM
REC6L2-41112-A3	6L2-41112-A2

 20D/M  
25N/M



REF	OEM
REC6K8-41124-A1	6K8-41124-A1

 25VE/M/B/BMH  
E25A  
30HM/HW/G/GE  
E30HMH

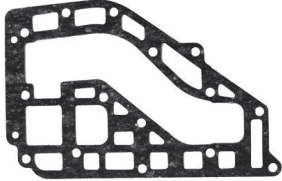

REF	OEM
PAF25-05010111	65W-41114-00

 F20/25  
T25

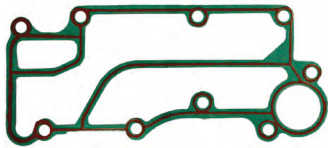

REF	OEM
REC689-41112-A0	689-41112-A0

 30A

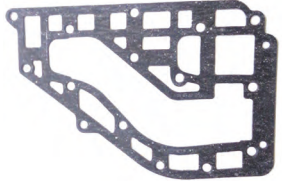

REF	OEM
REC6H3-41112-A0	6H3-41112-A0

 25B  
50G/GE  
60FE/TLR  
E60H  
70B/BE/TR

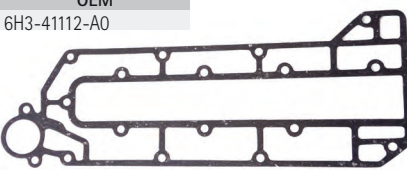

REF	OEM
REC689-41114-A0	689-41114-A0

 30A

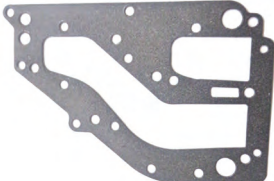

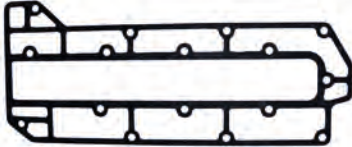

REF	OEM
REC6H3-41114-A0	6H3-41114-A0

 25B  
50G/GE  
60FE/TLR  
E60H  
70B/BE/TR



REF	OEM
REC67C-41114-00	67C-41114-00

 F30/40



REF	OEM
REC6H4-41112-A0	6H4-41112-A0

 25QEO  
40H/M/VE/TLR  
C40M/T  
50H/DE

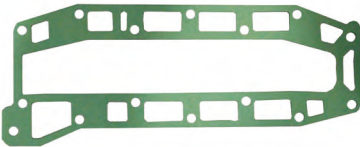

REF	OEM
REC66T-41114-A0	66T-41114-A0

 40X  
E40X

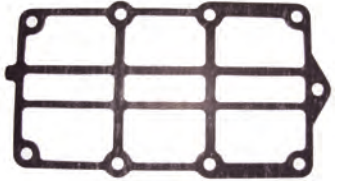

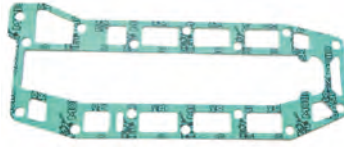

REF	OEM
REC6H4-41114-A0	6H4-41114-A0

 25QEO  
40H/M/VE/TLR  
C40M/T  
50H/DE



REF	OEM
REC6F5-41112-A0	6F5-41112-A0

 40GWH/JMH  
E40GMH





REF	OEM
REC6F5-41114-A0	6F5-41114-A0

40GWH/JMH  
E40GMH

REF	OEM
REC6E5-41112-A1	6E5-41112-A1

100A/AET/TLR  
115B/BE/TLR/CEO/TXR  
130BET/TLR

REF	OEM
REC6E9-41114-A0	6E9-41114-A0

40Q

REF	OEM
REC6G5-11382-A1	6G5-11382-A1

115HP-250HP

REF	OEM
REC676-41112-A0	676-41112-A0

40Q

REF	OEM
REC6G5-41112-A1	6G5-41112-A1

150F/FE/TLR/GE/A-CE,  
175D/DE/FE  
200AET/F/FE/TLR/G/GE/BE  
225D/DE/BE

REF	OEM
REC663-41114-00	663-41114-A0

55B  
E55CMH

REF	OEM
REC68F-41114-00	68F-41114-00

Z150  
175  
200HP

REF	OEM
REC688-41112-A0	688-41112-A0

75CET/TLR/AE  
E75B  
80AE  
85A/AE  
90A/AE/TLR

REF	OEM
REC6G5-41114-A0	6G5-41114-A0

150F/FE/TLR/GE/A-CE,  
175D/DE/FE  
200AET/F/FE/TLR/G/GE/BE  
225D/DE/BE

REF	OEM
REC688-41114-A0	688-41114-A0

75CET/TLR/AE  
E75B  
80AE  
85A/AE  
90A/AE/TLR



	REF	CEF	OEM	A	B	C
2A/B/C	REC646-44352-01	CEF500324	646-44352-01	11,5	47,5	13,7
F2.5, 3A, MALTA	REC6L5-44352-00	CEF500322	6L5-44352-00	10	36	14,5
4A/B, F4A, F4B, F5A, F6C, 5C	REC6E0-44352-00	CEF500325	6E0-44352-00	11	40	12,6
F6A/B, F8C, F9.9F, F9.9J	REC68T-44352-00	CEF500368	68T-44352-00	11,6	53	14
E8D	REC662-44352-01	CEF500321	662-44352-01	14	40	22
6C/D, 8C	REC6G1-44352-00	CEF500302	6G1-44352-00	11,9	40	18
F8, F9.9A/B/D, FT9.9A, 15D/9.9D	REC682-44352-01	CEF500320	682-44352-03	13	40	22
FT8D, 9.9F, F9.9C, FT9.9D, 15F, F15A-C, F20B, FT9.9G/L	REC63V-44352-01	CEF500363	63V-44352-01	12,85	53	14
20C, 25D, 30A	REC689-44352-02	CEF500326	689-44352-02	16,5	69,5	12,72
20D, 25N	REC6L2-44352-00	CEF500384	6L2-44352-00	13,97	51,2	19,05
F20A, F25A/D/G, FT25B, 25B/J/V, F30A, 30D/H/G, F40B/F, 40H/X, 50D	REC6H4-44352-02	CEF500385G	6H4-44352-02	16,1	51,2	19,05
F40A/C, 40V/F/Y, F45A, 50G/H, 55B, PRO50, F50A/B/F, FT50B/C/G, F50H, FT50J, F60A/C/F, FT60B/D/G, 60F, 70B, F70A	REC6H3-44352-00	CEF500316	6H3-44352-00	18,05	51,8	19
40Q	REC6F5-44352-00	CEF500352	6F5-44352-00	16,04	69,8	22,1
60F'04-, 70B'04-, 75A/C, PRO75, 80A, 85A, 90A	REC688-44352-03	CEF500323	688-44352-03	20,1	58	30
F80A/B, F100A/D	REC67F-44352-00	CEF500364	67F-44352-00	20	58,2	34,7
F(L)115A/F(L), 150A, V4/V6, F100F, F175, 200F/G	REC6E5-44352-01	CEF500371	6E5-44352-01	22,4	89	31
F(L)225F, F(L) 250D, F(L)300B	REC6CE-44352-00	CEF500401N	6CE-44352-00	22,5	90	36
F300, F350	REC6AW-44352-00	CEF500389N	6AW-44352-00	24,6	89	36

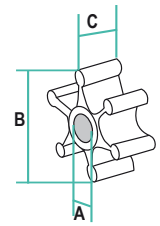

REC646-44352-01



REC6L5-44352-00



REC6E0-44352-00



REC68T-44352-00



REC662-44352-01



REC6G1-44352-00



REC682-44352-01



REC63V-44352-01



REC689-44352-02



REC6L2-44352-00



REC6H4-44352-02



REC6H3-44352-00



REC6F5-44352-00

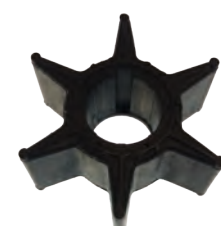

REC688-44352-03



REC67F-44352-00



REC6E5-44352-01



REC6CE-44352-00



REC6AW-44352-00

KITS DE JUNTAS

GASKETS KIT

KIT GUARNIZIONE

KITS JOINTS

REF	OEM
REC6A1-W0001-22	6A1-W0001-22

2B

REF	OEM
REC69G-W0001-20	69G-W0001-20

FT8/T8  
FT9.9/T9.9

REF	OEM
REC6A1-W0001-23	6A1-W0001-23

2B  
2MSH

REF	OEM
REC6G9-W0001-C6	6G9-W0001-C6

F8  
F9.9

REF	OEM
REC6E0-W0001-C1	6E0-W0001-C1

F4/F5/F6  
4AC  
MSH  
5C/CS/CMH

REF	OEM
REC66M-W0001-20	66M-W0001-20

F9.9  
F13.5  
F15

REF	OEM
REC6G1-W0001-C1	6G1-W0001-C0

6C/CMH/MSH/TRV/D/DMH  
8C/MSH/CMH/TRV

REF	OEM
REC683-W0001-21	683-W0001-C1

9.9D/15D

REF	OEM
REC68T-W0001-20	68T-W0001-20

F6/F8/F9.9

REF	OEM
REC63V-W0001-21	63V-W0001-21

9.9/15F  
13.5AWH

REF	OEM
REC6G9-W0001-C4	6G9-W0001-C4

F8  
F9.9

YAMAHA

RECAMBIOS MARINOS



REF	OEM
REC689-W0001-C2	6689-W0001-C2

 20C/CM  
 25D  
 30A

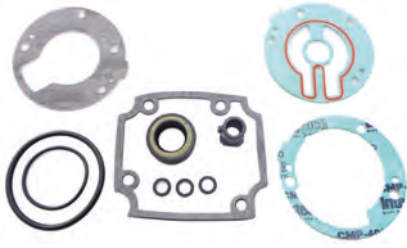

REF	OEM
REC6L2-W0001-C3	6L2-W0001-C3

 25D/NWC/MLH/MSH





REF	OEM
REC689-W0001-21	689-W0001-21

 55B



REF	OEM
REC61N-W0001-E1	61N-W0001-E1

 25V/VM/E25A  
 30G/GE



REF	OEM
REC698-W0001-21	698-W0001-21

 E48  
 E48CMH  
 55B/BM/BET  
 E55CMH

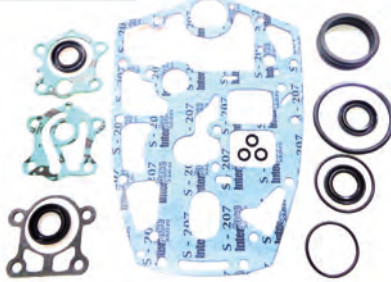

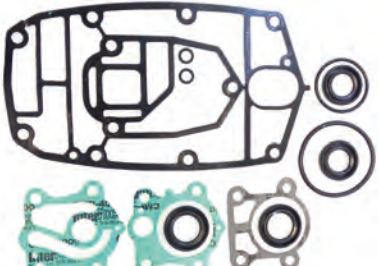

REF	OEM
REC6J8-W0001-21	6J8-W0001-21

 25J  
 30D/DMH





REF	OEM
REC689-W0001-20	689-W0001-20

 55BET



REF	OEM
REC6H3-W0001-22	6H3-W0001-22

 25B/BETO  
 50G/GEO/GETO  
 60FETO/FEDO/FE0/F/TLR  
 70B/BETO/BEMO





REF	OEM
REC65W-W0001-20	65W-W0001-20

 F20/25



REF	OEM
REC67F-W0001-20	67F-W0001-20

 F100A/T  
 F80A/T







REF	OEM
REC62Y-W0001-22	62Y-W0001-20,-21,-22

 F40A, ELH/F45AE, AET/F50A, AET, AED, AEDH, AEHT, TJR, TJRB, TLR, TLRA, TLRC, TLRZ, TLHC/FT50B/T50TLR (2000-07)





REF	OEM
REC64J-W0001-21	64J-W0001-21

 FT50, T50



REF	OEM
REC6F5-W0001-C0	6F5-W0001-C0

 40G/E40G



REF	OEM
REC69D-W0001-20	69D-W0001-20

 E60H

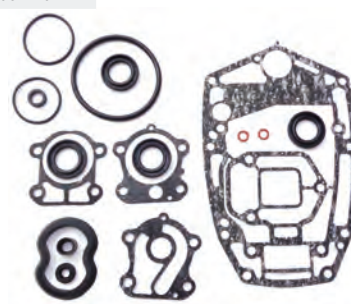

REF	OEM
REC66T-W0001-20	66T-W0001-20

 40X/E40X-MH/XW E40MCH

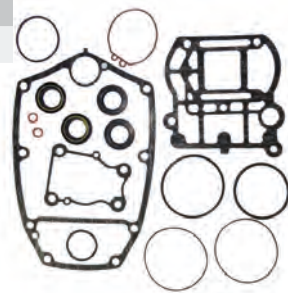

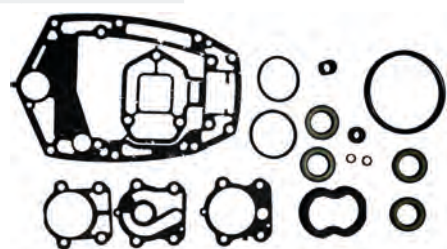

REF	OEM
REC6H2-W0001-20	6H2-W0001-20

 60FETO/TR 70BETO/TR



REF	OEM
REC6A0-W0001-21	6A0-W0001-21

 400E/G



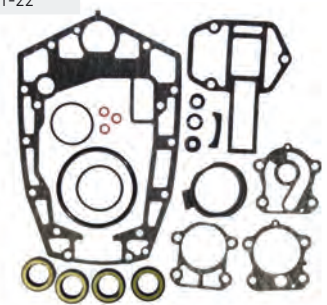

REF	OEM
REC688-W0001-22	688-W0001-22

 75CETO/E75B/AED 85A/AED/AET 90AETO/TR



REF	OEM
REC64J-W0001-20	64J-W0001-20

 F45/50 FT50 T50



REF	OEM
REC688-W0001-20	688-W0001-20

 75A/AE 80A 85A/AE 90A/AEO/AETO/ETN

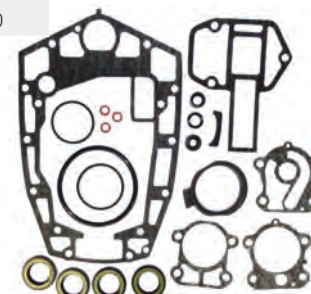

REF	OEM
REC68V-W0001-20	68V-W0001-20

F115

REF	OEM
REC69J-W0001-20-00	69J-W0001-20

F200/225

REF	OEM
REC6E5-W0001-F1	6E5-W0001-F1 6E5-W0001-21 6F3-W0001-21

115BETO/B/CEO/CETO/TXR  
130BETO  
E115AE

BOMBA DE AGUA

WATER PUMP

POMPA ACQUA

POMPE À EAU

CUERPO BOMBA DE AGUA

HOUSING, WATER PUMP

CORPO, POMPA ACQUA

CORPS DE POMPE À EAU

REF	OEM
PAF2.6-03000014	69M-G4311-00

F2.5

P. 283

REF	OEM
PAF20-04040001	6AH-44311-00

F9.9 / 13.5 / 15/20 F  
Última versión  
Last version  
Ultima versione  
Dernière version

P. 293

new

REF	OEM
PAF4-03000019	68D-G4311-01

F4

P. 285  
P. 343

REF	OEM
REC689-44311-00	689-44311-03

20C/CM  
25D/DE  
30A

P. 353

REF	OEM
REC63V-44301-00	63V-44301-00-00

F6/8/15/9.9/13.5  
T8/9.9  
9.9F/FEM/MH/MSH/FMH  
13.5AWH  
15F/FMH/MSH/MH

P. 289  
P. 291  
P. 351

REF	OEM
REC663-44311-02	663-44311-02-00

25B/BETO  
40N/H/E  
50G/GEO/GETO  
50D  
55B/BET  
E55CMH  
60FEO/FETO/FEDO

60BE/BEM/BET  
70CE

P. 357  
P. 359  
P. 369

REF	OEM
PAF25-04050001	61N-44311-01

25V  
 30G  
 F20  
 F25

P. 297  
 P. 355



REF	OEM
REC688-44311-01	688-44311-01

60FETO/TR  
 E60H-E-M  
 70BETO/TR  
 75CETO/TLR  
 E75B  
 75A/AE-T-M-D  
 80A/AE-O-T  
 85A/AE-D-T  
 90A/AETO/AEO/TLR

P. 371  
 P. 373



REF	OEM
REC63D-44311-01	63D-44311-00

40V/VM/VE/TLR  
 C40M-T  
 50H/HR-M/HM  
 F40/45/50/60

P. 309  
 P. 315



REF	OEM
REC67F-44311-01	67F-44311-01-00

F80/100

P. 321



REF	OEM
REC676-44311-00	676-44311-00

E40GM/JM  
 40GW/JW/G/QE/QWC



REF	OEM
REC61A-44311-00	6E5-44311-00

F80/100/115/150/200/225/250  
 150F/FET/TR/AET  
 Z150P/TXR  
 175D 200F/FETO/G/GETO  
 200AET  
 225B/DET/G  
 250GETO/AET  
 Z250DET/FET

P. 325  
 P. 329  
 P. 333  
 P. 339  
 P. 377  
 P. 381  
 P. 385  
 P. 386



REF	OEM
PAT40-04000201	66T-44311-00

40X/E40X-MLH  
 T25/FT25  
 F30/F40

P. 305  
 P. 301

*new*



REF	OEM
REC6CE-44311-01	6CE-44311-00 6CE-44311-01

F250 (2011+) V6  
 F300 (2011+) V6

P. 335

*new*



REF	OEM
REC6H3-44311-00	6H3-44311-00

FT/T 50/60 HP (1997+)  
 60F (1984-99)

*new*



REF	OEM
REC6AW-44311-01	6AW-44311-00 6AW-44311-01

F300 (2008-11) V8  
 F350 (2008+) V8

P. 341

*new*



TAPA DE LA BOMBA

WATER PUMP, COVER

COPERCHIO POMPA

PLAQUE DE POMPE À EAU

REF	OEM
REC646-44323-00	646-44323-00

2B  
 2MSH  
 2BMH



REF	OEM
PAF2.6-03000010	69M-G4323-00

F2.5





REF	OEM
REC6L5-44323-00	6L5-44323-00



3A/AMH  
3MSH



REF	OEM
REC676-44323-00-40	676-44323-00



E40GMH/GW/JMH  
40JWH/GWH  
40QE/G/QM/QE-2/QWC

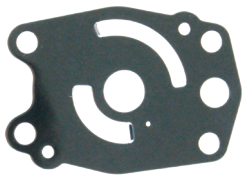

REF	OEM
REC67F-44323-00	67F-44323-00



F75/F80/F100



REF	OEM
REC66T-44323-00	66T-44323-00



40X/E40X/MLH  
40XW/XMH  
F30/40/T25



REF	OEM
REC68T-44323-00	68T-44323-00



F6  
T8  
F9.9  
F20/6/9.9/8/13.5  
T8/9.9



REF	OEM
REC663-44323-00	663-44323-00



50G/GEO/GETO  
25Q/QEO/B  
55B/BE/BM  
30DET/DEO/DMH/ELH  
60FEO  
FETO  
FEDO  
70BEO/BETO/BEMO/CE  
40N/H

50ETN/D/DE  
25J/JEO/JETO/ESH  
25Q/QEO/E55CMH  
30DET/DEO/DMH/D  
55B/BM/BET  
40E/H  
50D/DE  
25J/JEO/JETO/ESH



REF	OEM
REC63V-44323-00	63V-44323-00-00



9.9F/FMH/FEMH/MSH  
F9.9/13.5/15  
13.5AWH  
15F/FM/MS



REF	OEM
REC688-44323-00	688-44323-00-00



60FET/TR  
75CETO/AED-T  
70BET/TR  
75A/AE-M/TLR/CETO/AED-T  
E75B

80A/AET/TLR  
85A/AE-D-T  
90A/AET/ETN/TR



REF	OEM
REC6H3-44323-00	6H3-44323-00-00



25B/BETO  
F45  
50G/GE  
T50  
F50

FT50  
60FE/TLR  
FT60  
T60  
70B/ETN/BE



REF	OEM
REC6E5-44323-00-40	6E5-44323-00



100A/AET/TLR  
115CET/A/B/BET  
C115TLR  
130BET  
140AET/BET



REF	OEM
REC61N-44323-00	61N-44323-00



25B/BMH/30H  
E30HM  
30G  
E25A

25VE-M  
F20/F25



REF	OEM
REC68V-44323-00	6EK-44323-00



F115



REF	OEM
REC6P2-44323-00	6P2-44323-0



Z250  
F225/F250



REF	OEM
REC6G5-44323-00	6G5-44323-01



F150/200/225  
Z150/175/250/300  
VZ200  
250AET/B/GET  
225C/CET/D/DET  
150F/FET/AET

175D/DET/AET  
200F/FET/GE  
225G  
200AET/BET  
150CET  
175BET



REF	OEM
REC63D-44323-00	63D-44323-00-00



F30/40/45/50/60  
40V/VE-M/Y/YE  
C40MLH/T  
T50  
50H/HM-R





**KITS DE REPARACIÓN BOMBA DE AGUA**

**WATER PUMP SERVICE KITS**

**KIT RICAMBI POMPA ACQUA**

**KIT REPARATION DE POMPE A EAU**

REF	OEM
REC6E0-W0078-A2	6E0-W0078-A2 6E0-W0078-00 6E0-W0078-01 6E0-W0078-02

**new**

REF	OEM
REC69G-W0078-01	69G-W0078-01 69G-W0078-00

FT/T8 D/P/E/M/G (2005+)  
FT/T9.9 E/G/M/L (2008+)

**new**

REF	OEM
REC6A1-W0078-01	6A1-W0078-01

2B (1985-88)

**new**

REF	OEM
REC6AH-W0078-00	6AH-W0078-00 6AH-W0078-01

F9.9 (2009+)  
F13.5B (2007-09)  
F15C/E/M (2007+)  
F20B/M (2007+)

**new**

REF	OEM
REC6EE-W0078-01	6BX-WG0078-00 6EE-W0078-00 6EE-W0078-01

F4B/M (2010+)  
F5A/M (2010+)  
F6C/M (2010+)

**new**

REF	OEM
REC63V-W0078-01	63V-W0078-00

9.9F  
13.5AWH  
15F  
F9.9  
F15  
F13.5

REF	OEM
REC68T-W0078-00	68T-W0078-01 68T-W0078-00

F6A/B/M (2005-09)  
F8C/F/M (2005+)  
F9.9 F/M/J (2008+)

**new**

REF	OEM
REC682-W0078-A1	682-W0078-A1

9.9/15D  
F8  
F9.9

REF	OEM
REC6G1-W0078-A1	6G1-W0078-A1 6G1-W0078-00 6N0-W0078-A0 6G1-W0078-01

6C/D/M/T (1984-14)  
8C/N/J/F/T/M (1984-18)

**new**

REF	OEM
REC61N-W0078-11	61N-W0078-11 61N-W0078-10

F20A/D (1998-17)  
F25A/E/T/M/D (1998-18)

**new**

REF	OEM
REC689-W0078-04	689-W0078-04

20CM

REF	OEM
REC6BG-W0078-00	6BG-W0078-00

F30B (2009+)  
F40A/F (2009+)

REF	OEM
REC689-W0078-A6	689-W0078-A6

20C  
25D

REF	OEM
REC6CJ-W0078-00	6CJ-W0078-00

F40G (2011+)  
F70A (2011+)

REF	OEM
REC6L2-W0078-00	6L2-W0078-00

20NE/NEMO/N/MLH/MSH/NW/NMH/D  
20D/DEO/DEM/MSH/DM/MLH  
20MSH/DMH/DWO

REF	OEM
REC63D-W0078-01	63D-W0078-01

40V/C40 (1998+)  
50H (1997-03)  
F45A (1997-00)  
F50A/H/F/T (1997+)  
F40A/E/Y/D/H (1999+)  
F60A/B/C/T (2002+)  
F40/45/50/60  
40V/MMH/VETO/MMH  
C40MLH/T/TLR  
40VE/VEO/VES  
40Y/YETO  
50H/HET/HMH

REF	OEM
REC6J8-W0078-A2	6J8-W0078-A1

25J/JEO  
30D/DE/DMH

REF	OEM
REC679-W0078-A1	679-W0078-00

40QE

REF	OEM
REC6H4-W0078-00	6H4-W0078-00

25Q/QEO  
40N/H/HE  
E48CMH  
50D/DE/AETN  
E55CMH

REF	OEM
REC6F5-W0078-A0	6F5-W0078-00

E40GMH  
40GWH

REF	OEM
REC66T-W0078-00	66T-W0078-01

40X  
E40X

REF	OEM
REC67F-W0078-00	67F-W0078-00

F80/100

REF	OEM
REC663-W0078-01	663-W0078-01

55B (1992-18)  
55BET

**new**

REF	OEM
REC6N6-W0078-02	6N6-W0078-00

115B/BE/BET/CETO/TRX/CETO  
130BET/TLR

REF	OEM
REC6K5-W0078-01	6K5-W0078-01

E60HM  
E-60H

REF	OEM
REC68V-W0078-00	68V-W0078-00

F115  
FL115  
LF115

REF	OEM
REC6H3-W0078-02	6H3-W0078-00

60FE/FET/FEO/FETO  
70AETN/B/BEH/BEO/CE

REF	OEM
REC65N-W0078-A1	65N-W0078-A1

D150H/N/NETOL

REF	OEM
REC692-W0078-02	692-W0078-02

60TR/FETO  
75AED/AET  
75CETO/TLR/E75B  
70BETO/TR  
80A  
85A/AE/AED/AET/AEM  
90A/AETO/AEMO/TLR  
C90TRZ

REF	OEM
REC6G5-W0078-A1	6G5-W0078-00 6G5-W0078-01 6G5-W0078-A1

150A/C/E (1984-91)  
175A/B (1984-91)  
200A/E/B (1984-91)  
225A/B (1987-91)

**new**



**new**

REF	OEM
REC6P2-W0078-00	6P2-W0078-00

F225C/T (2008-15)  
F250B/T/A (2009+)

**new**

REF	OEM
REC6CE-W0078-01	6CE-W0078-01 6CE-W0078-00

F300A/B/C (2001+) V6  
F250 C/D (2001+) V6  
F225 C/F/L (2011+) V6

REF	OEM
REC61A-W0078-A1	61A-W0078-01

250ETD/AET/AET  
150FETO  
175FETO  
200FETO

**new**

REF	OEM
REC6AW-W0078-00	6AW-W0078-00

F300A/T (2008-11) V8  
F350A/C/T (2008+) V8

REF	OEM
REC60X-W0078-00	60X-W0078-00

Z250FETO  
V250TLR  
Z300BETO  
V300TLR

**GUÍA  
KITS DE BOMBA DE AGUA**

**GUIDE OF WATER PUMP  
SERVICE KITS**

**GUIDA  
KIT POMPA ACQUA**

**GUIDE  
KITS POMPES À EAU**

		REF	OEM		
4AC/AS	1985-96	REC6E0-W0078-A2	6E0-W0078-A2, -00,-01,-02		
5C/CS	1985-96				
F9.9	6CA1 - 6AC9	REC6AH-W0078-00	6AH-W0078-00		
F13.5	6AF1 - 6AF3				
F15	6AG1 - 6AG9				
F15	6AGA - 6AGB				
F20	6AH1 - 6AH9				
F20	6AHA - 6AHB				
F300	6BK1 - 6BK4				
F300	6BJ1 - 6BJ4				
F350	6AW1 - 6AW9			REC6AW-W0078-00	6AW-W0078-00
F350	6AX1 - 6AX9				

			REF	OEM
F30	6BT1 - 6BT9	2009-16	REC6BG-W0078-00	6BG-W0078-00
F40	6BG1 - 6BG9	2009-16		
F40	6CY1 - 6CY7	2011-16	REC6CJ-W0078-00	6CJ-W0078-00
F70	6CJ1 - 6CJ7	2011-16		
F225	6CL1 - 6CL4	2011-13	REC6CE-W0078-01	6CE-W0078-00,-01
F225	6CM1 - 6CM4	2011-13		
F250	6CG1 - 6CG4	2011-13		
F250	6CH1 - 6CH4	2011-13		
F300	6CE1 - 6CE4	2011-13		
F300	6CF1 - 6CF4	2011-13		



**GUÍA BOMBAS DE AGUA**

**GUIDE WATER PUMP**

**GUIDA POMPA ACQUA**

**GUIDE POMPE À EAU**

		1	2	3	4	5	6	7	KIT	
F2.5	69F0 > 69F3 60N1 > 60N5	2003	REC6L5-44352-00	PAF2.6-03000015	PAF2.6-03000010	PAF2.6-03000014	PAJASOF404-19-033	PAF4-03000021	PAF2.6-03000013	
F4	68R > 68R3 60P1 > 60P2	2002-09	REC6E0-44352-00	REC6E0-44322-02	PAF4-03000015	PAF4-03000019	PAF4-03000018	PAF4-03000021	PAF4-03000016	
F5		2010	REC6E0-44352-00	PAF6-03000002		PAF6-03000001		PAF4-03000021	PAF4-03000016	
F6B, BMH, A, AM, AW, ML, MH	6J6 > 6J7	2001-09	REC68T-44352-00	REC63V-44322-00	REC68T-44323-00	REC63V-44301-00	REC93210-44398	REC68T-44366-00	REC664-44338-00	REC68T-W0078-00
F6A, ML, MS, AM, BM	60R1 > 60R9 68T > 68T3 60RA > 60RB 6FW1	2000-06	REC68T-44352-00	REC63V-44322-00	REC68T-44323-00	REC63V-44301-00	REC93210-44398	REC68T-44366-00	REC664-44338-00	REC68T-W0078-00
F6 (1cyl)		2010	REC6E0-44352-00	PAF6-03000002		PAF6-03000001	PAF4-03000018	PAF4-03000021	PAF4-03000016	
F8AM, B, BE, BM	6G8	1986-95	REC682-44352-01	REC682-44322-00	REC682-44323-40		REC682-44315-00	REC682-44365-00	REC90280-03024	REC682-W0078-A1
F8C, ML, CM, MS, MH, ML, FM	6G9	2000-15	REC68T-44352-00	REC63V-44322-00	REC68T-44323-00	REC63V-44301-00	REC93210-44398	REC68T-44366-00	REC664-44338-00	REC68T-W0078-00
T8		2001-10	REC63V-44352-01	REC63V-44322-00	REC68T-44323-00	REC63V-44301-00	REC93210-44398	REC68T-44366-00	REC664-44338-00	
F9.9A, AE, AM	66N>66N8	1985-96	REC682-44352-01	REC682-44322-00	REC682-44323-40		REC682-44315-00	REC682-44365-00	REC90280-03024	REC682-W0078-A1
F9.9B, BE, BM	6AU1>6AU6 6DR1>6DR3	1985-96	REC682-44352-01	REC682-44322-00	REC682-44323-40		REC682-44315-00	REC682-44365-00	REC90280-03024	REC682-W0078-A1
F9.9	66R>66R8	1985-04	REC682-44352-01	REC682-44322-00	REC682-44323-40		REC682-44315-00	REC682-44365-00	REC90280-03024	REC682-W0078-A1
F9.9C, CE, CM, CW, MH	69C>69C1	1998-08	REC63V-44352-01	REC63V-44322-00	REC63V-44323-00	REC63V-44301-00	REC93210-44398	REC647-44366-00	REC664-44338-00	REC63V-W0078-01
F9.9F, FE, FM, MH, ML, JE, JM		2008-15	REC63V-44352-01	REC63V-44322-00	REC68T-44323-00	REC63V-44301-00	REC93210-44398	REC68T-44366-00	REC664-44338-00	REC68T-W0078-00
F19.9D, DE, DM, DW		1999-08	REC63V-44352-01	REC63V-44322-00	REC63V-44323-00	REC63V-44301-00	REC93210-44398	REC647-44366-00	REC664-44338-00	REC63V-W0078-01
F19.9D, DEP, PLR, TR	6CA1>6CA8	2000-02	REC63V-44352-01	REC63V-44322-00	REC63V-44323-00	REC63V-44301-00	REC93210-44398	REC647-44366-00	REC664-44338-00	REC63V-W0078-01
F19.9		1985-99	REC682-44352-01	REC682-44322-00	REC682-44323-40		REC682-44315-00	REC682-44365-00	REC90280-03024	REC682-W0078-A1
T9.9	69V2>69V8	1991-99	REC682-44352-01	REC682-44322-00	REC682-44323-40		REC682-44315-00	REC682-44365-00	REC90280-03024	REC682-W0078-A1
F9.9HE, HMH	6P71>6P74	2009-15	REC63V-44352-01	REC63V-44322-00				PAF25-04050004	REC664-44338-00	REC6AH-W0078-00
T9.9	6AF1>6AF3	2005-06	REC63V-44352-01	REC63V-44322-00	REC63V-44323-00	REC63V-44301-00	REC93210-44398	REC647-44366-00	REC664-44338-00	REC63V-W0078-01
F13.5AE, AM	66M>66M7	2002-07	REC63V-44352-01	REC63V-44322-00	REC63V-44323-00	REC63V-44301-00	REC93210-44398	REC647-44366-00	REC664-44338-00	REC63V-W0078-01
F13.5AE, P		2005-07	REC63V-44352-01	REC63V-44322-00	REC63V-44323-00	REC63V-44301-00	REC93210-44398	REC647-44366-00	REC664-44338-00	REC63V-W0078-01
F13.5B, BMH	6AG1>6AG9 6AGA	2007-09	REC63V-44352-01	REC63V-44322-00				PAF25-04050004	REC664-44338-00	REC6AH-W0078-00
F15A, AE, AM, EL, MH	65P1>65P5	1998-07	REC63V-44352-01	REC63V-44322-00	REC63V-44323-00	REC63V-44301-00	REC93210-44398	REC647-44366-00	REC664-44338-00	REC63V-W0078-01
F15	6DN1>6DN6	2006-11	REC63V-44352-01	REC63V-44322-00	REC68T-44323-00		REC93210-49046	PAF25-04050004	REC664-44338-00	
F15CE, CM, CW, EL, MH	6AH1>6AH9 6AHA	2007-15	REC63V-44352-01	REC63V-44322-00				PAF25-04050004	REC664-44338-00	REC6AH-W0078-00
F20AE	65W>65W9	2003-06	REC6H4-44352-02	REC61N-44322-00	REC61N-44323-00	PAF25-04050001	PAF25-04050003	PAF25-04050004	REC90280-03024	REC61N-W0078-11
F20DET	68P1>68P8	2011-15	REC6H4-44352-02	REC61N-44322-00	REC61N-44323-00	PAF25-04050001	PAF25-04050003	PAF25-04050004	REC90280-03024	REC61N-W0078-11
F20B, BE, BM, BW, EL, MH		2007-15	REC63V-44352-01	REC63V-44322-00				PAF25-04050004	REC664-44338-00	REC6AH-W0078-00
F25A, AE, AM, AW, EL, MH		1998-09	REC6H4-44352-02	REC61N-44322-00	REC61N-44323-00	PAF25-04050001	PAF25-04050003	PAF25-04050004	REC90280-03024	REC61N-W0078-11
F25DE, DM, MH	6BT1>6BT8	2009-215	REC6H4-44352-02	REC61N-44322-00	REC61N-44323-00	PAF25-04050001	PAF25-04050003	PAF25-04050004	REC90280-03024	REC61N-W0078-11
T25	66W>66W1	2001-06, 2009	REC6H4-44352-02	REC63D-44322-00	REC66T-44323-00		REC93210-59MG7	REC90280-03M03	REC66T-W0078-00	
F30	60K1	2001-05	REC6H4-44352-02	REC63D-44322-00	REC66T-44323-00		REC93210-59MG7	REC90280-03M03	REC66T-W0078-00	
F30BE		2009-15	REC6H4-44352-02	REC63D-44322-00	REC63D-44323-00		REC93210-59MG7	REC663-44366-00	REC90280-03M03	REC6BG-W0078-00
F40 A, ELH	6BG1>6BG8	1999-02	REC6H3-44352-00	REC63D-44322-00	REC63D-44323-00		REC93210-59MG7	REC90280-03024	REC63D-W0078-01	
F40 CET	6AK1>6AK9 6AKA>6AKB	2002	REC6H3-44352-00	REC63D-44322-00	REC63D-44323-00		REC93210-59MG7	REC90280-03024	REC63D-W0078-01	
F40	6CY1>6CY6	2000-08	REC6H4-44352-02	REC63D-44322-00	REC66T-44323-00		REC93210-59MG7	REC90280-03M03	REC66T-W0078-00	
F40FE	62Y	2009-15	REC6H4-44352-02	REC63D-44322-00	REC63D-44323-00		REC93210-59MG7	REC663-44366-00	REC90280-03M03	REC6BG-W0078-00
F40D, DE, HE	62Y	2006-15	REC6H3-44352-00	REC63D-44322-00	REC63D-44323-00		REC93210-59MG7	REC663-44366-00	REC90280-03024	REC63D-W0078-01
F40GET	62Y>62Y6	2011-15	REC6H3-44352-00 REC63D-44322-00					REC663-44366-00	REC90280-03M03	REC6CJ-W0078-00
F45 AET	60A3 60AA	1999	REC6H4-44352-02	REC61N-44322-00	REC61N-44323-00	PAF25-04050001	PAF25-04050003	PAF25-04050004	REC90280-03024	REC61N-W0078-11
F50TJR	6C11>6C19	2003	REC6H4-44352-02	REC61N-44322-00	REC61N-44323-00	PAF25-04050001	PAF25-04050003	PAF25-04050004	REC90280-03024	REC61N-W0078-11
F50 A, AE, TJ, TL	6C1A>6C1C	1997-07	REC6H3-44352-00	REC63D-44322-00	REC63D-44323-00		REC93210-59MG7	REC663-44366-00	REC90280-03024	REC63D-W0078-01
F50 DETL	64J	1995-10	REC6H3-44352-00	REC63D-44322-00	REC63D-44323-00		REC93210-59MG7	REC663-44366-00	REC90280-03024	REC63D-W0078-01
F50F, FE, TR, TL		2005-12	REC6H3-44352-00	REC63D-44322-00	REC63D-44323-00		REC93210-59MG7	REC663-44366-00	REC90280-03024	REC63D-W0078-01
F50 HED	69W1>69W6	2013-15	REC6H3-44352-00	REC63D-44322-00	REC63D-44323-00		REC93210-59MG7	REC663-44366-00	REC90280-03024	REC63D-W0078-01
F50B, T50TLR	6C51>6C59	1997-99	REC6H3-44352-00	REC63D-44322-00	REC63D-44323-00		REC93210-59MG7	REC663-44366-00	REC90280-03024	REC63D-W0078-01
T50	6C5A>6C5C	1996	REC6H3-44352-00	REC663-44322-00	REC6H3-44323-00		REC6H3-44315-00	REC90280-03024	REC6H3-W0078-02	
F60 AE, TL, TJ		2002-07	REC6H3-44352-00	REC63D-44322-00	REC63D-44323-00		REC6H3-44315-00	REC663-44366-00	REC90280-03M03	REC63D-W0078-01
F60 A, C, CET, TR, TJR	6CJ1>6CJ6	2005-12	REC6H3-44352-00	REC63D-44322-00	REC63D-44323-00		REC6H3-44315-00	REC663-44366-00	REC90280-03M03	REC63D-W0078-01
F60 B, FET	6D61	2013-15	REC6H3-44352-00	REC63D-44322-00	REC63D-44323-00		REC6H3-44315-00	REC663-44366-00	REC90280-03M03	REC63D-W0078-01
T60	67G0>67G5	2003-11	REC6H3-44352-00	REC663-44322-00	REC6H3-44323-00		REC6H3-44315-00	REC90280-03M03	REC6H3-W0078-02	
F70A, AET	6D71>6D79 6D7A>6D7C	2011-15	REC6H3-44352-00 REC63D-44322-00					REC663-44366-00	REC90280-03M03	REC6CJ-W0078-00
F75BET, TR, TLR		2005	REC67F-44352-00	REC67F-44322-00	REC67F-44323-00	REC67F-44311-01	REC688-44315-00	REC90280-04M04	REC67F-W0078-00	
F80A, AET, TLR, TJR	67F>67F5	1999-03	REC67F-44352-00	REC67F-44322-00	REC67F-44323-00	REC67F-44311-01	REC688-44315-00	REC90280-04M04	REC67F-W0078-00	
F80B, BET	6D91>6D99 6D9A>6D9C	2005-15	REC67F-44352-00	REC67F-44322-00	REC67F-44323-00	REC67F-44311-01	REC688-44315-00	REC90280-04M04	REC67F-W0078-00	
F90	68V, 68V0, 68W0	2003-11	REC67F-44352-00	REC67F-44322-00	REC67F-44323-00	REC67F-44311-01	REC688-44315-00	REC90280-04M04	REC67F-W0078-00	
F100A, AET, TLR, TRZ		1999-06	REC67F-44352-00	REC67F-44322-00	REC67F-44323-00	REC67F-44311-01	REC688-44315-00	REC90280-04M04	REC67F-W0078-00	

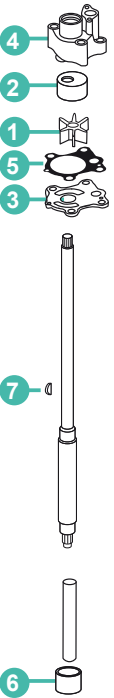



			1	2	3	4	5	6	7	KIT
F100DET	68V, 68VO, 68W0	2005-15	REC67F-44352-00	REC67F-44322-00	REC67F-44323-00	REC67F-44311-01	REC688-44315-00		REC90280-04M04	REC67F-W0078-00
F115A (68V/68VO)		2000-01	REC6E5-44352-01	REC61A-44322-02	REC6E5-44323-00-40	REC6E5-44311-00	REC93210-86M38	REC6E5-44366-00	REC90280-04M05	REC6N6-W0078-02
F115TLR (68V)	68V1>68V9 68VA>68VF	2000	REC6E5-44352-01	REC61A-44322-02	REC6E5-44323-00-40	REC6E5-44311-00	REC93210-86M38	REC6E5-44366-00	REC90280-04M05	REC6N6-W0078-02
F115TLR/ TRZ/ TXR	68W1>68W9 68WA>68WF	2000-01	REC6E5-44352-01	REC61A-44322-02	REC6E5-44323-00-40	REC6E5-44311-00	REC93210-86M38	REC6E5-44366-00	REC90280-04M05	REC6N6-W0078-02
LF115TXR (68W/68W0)	6EK1>6EK2 6EL1>6EL2	2000-01	REC6E5-44352-01	REC61A-44322-02	REC6E5-44323-00-40	REC6E5-44311-00	REC93210-86M38	REC6E5-44366-00	REC90280-04M05	REC6N6-W0078-02
F115A, AET, TJR6EM1		2002-15	REC6E5-44352-01	REC61A-44322-02	REC68V-44323-00	REC61A-44311-00	REC93210-86M38	REC6E5-44365-00	REC90280-04M05	REC68V-W0078-00
LF/FL115A, AET, TX, TR, B, BET		2002-15	REC6E5-44352-01	REC61A-44322-02	REC68V-44323-00	REC61A-44311-00	REC93210-86M38	REC6E5-44365-00	REC90280-04M05	REC68V-W0078-00
FL/FL115B, BET		2014-15	REC6E5-44352-01	REC61A-44322-02	REC68V-44323-00	REC61A-44311-00	REC93210-86M38	REC6E5-44365-00	REC90280-04M05	REC68V-W0078-00
F130A, AET		2015	REC6E5-44352-01	REC61A-44322-02	REC68V-44323-00	REC61A-44311-00	REC93210-86M38	REC6E5-44365-00	REC90280-04M05	REC68V-W0078-00
F150/FL150		2004-12	REC6E5-44352-01	REC61A-44322-02	REC6G5-44323-00	REC61A-44311-00	REC93210-86M38	REC6E5-44365-00	REC90280-04M05	REC61A-W0078-A1
F200/FL200		2002-11	REC6E5-44352-01	REC61A-44322-02	REC6G5-44323-00	REC61A-44311-00	REC93210-86M38	REC6E5-44365-00	REC90280-04M05	REC61A-W0078-A1
VF200	6BB2>6BB9	2009-11	REC6E5-44352-01	REC61A-44322-02		REC61A-44311-00	REC93210-86M38	REC6E5-44365-00		
F225/FL225	6CL1>6CL4 6CM1>6CM4	2002-10	REC6E5-44352-01	REC61A-44322-02	REC6G5-44323-00	REC61A-44311-00	REC93210-86M38	REC6E5-44365-00	REC90280-04M05	REC61A-W0078-A1
F225/FL225		2007-09 (20")	REC6E5-44352-01	REC61A-44322-02	REC6P2-44323-00	REC61A-44311-00	REC93210-86M38	REC6E5-44365-00	REC90280-04M05	REC6P2-W0078-00
F225CET		2009-15	REC6E5-44352-01	REC61A-44322-02	REC6P2-44323-00	REC61A-44311-00	REC93210-86M38	REC6E5-44365-00	REC90280-04M05	REC6P2-W0078-00
LF/FL/F225CA, FET	6BR1>6BR3 6BS1>6BS3	2011-13	REC6CE-44352-00							
VF225	6P2A 6P23>6P29	2009-11	REC6E5-44352-01	REC61A-44322-02		REC61A-44311-00	REC93210-86M38	REC6E5-44365-00		
F250/FL250	6P33>6P39	2005	REC6E5-44352-01	REC61A-44322-02	REC6G5-44323-00	REC61A-44311-00	REC93210-86M38	REC6E5-44365-00	REC90280-04M05	REC61A-W0078-A1
FL/F250BET	6CG1>6CG4 6CH1>6CH4	2001-11	REC6E5-44352-01	REC61A-44322-02	REC6P2-44323-00	REC61A-44311-00	REC93210-86M38	REC6E5-44365-00	REC90280-04M05	REC6P2-W0078-00
F250A, AET, TR, TUR		2007-13	REC6E5-44352-01	REC61A-44322-02	REC6P2-44323-00	REC61A-44311-00	REC93210-86M38	REC6E5-44365-00	REC90280-04M05	REC6P2-W0078-00
LF/FL250A, AET, TR, TX	6CF1>6CF4 6CF1>6CF4	2007-12	REC6E5-44352-01	REC61A-44322-02	REC6P2-44323-00	REC61A-44311-00	REC93210-86M38	REC6E5-44365-00	REC90280-04M05	REC6P2-W0078-00
LF/FL/F250CA, DET	6B11>6B14 6BK1>6BK4	2011-13	REC6CE-44352-00							
VF250	6AW1>6AW9	2009-10	REC6E5-44352-01	REC61A-44322-02		REC61A-44311-00	REC93210-86M38	REC6E5-44365-00	REC90280-04M05	
F300/FL- 300BET, CA	6AX1>6AX9	2011-13	REC6CE-44352-00							
F300/FL300AET		2008-11	CEF500389N							REC6AW-W0078-00
F350AET, CB, TRG, TUR		2008-15	CEF500389N							REC6AW-W0078-00
LF/FL350AET, CB, TRG, TUR		2008-15	CEF500389N							REC6AW-W0078-00

2T  
STROKESGUÍA  
BOMBAS DE AGUAGUIDE  
WATER PUMPGUIDA  
POMPA ACQUAGUIDE  
POMPE À EAU

			1	2	3	4	5	6	7	KIT
2B	6A1	1985-99			REC646-44323-00					REC6A1-W0078-01
2B, MSHA	6A11>6A12 6F89	2002-10	REC646-44352-01		REC646-44323-00					
4AC, AS	6E0>6E1	1985-96	REC6E0-44352-00	REC6E0-44322-02	PAF4-03000015			PAF4-03000021		REC6E0-W0078-A2
5C, CS	6E3>6E4	1985-96	REC6E0-44352-00	REC6E0-44322-02	PAF4-03000015			PAF4-03000021		REC6E0-W0078-A2
6 D /DEM	6H8	1984-96	REC6G1-44352-00	REC6G1-44322-02	REC6G1-44323-00		REC6G1-44315-A0	REC647-44366-00	REC90280-03024	REC6G1-W0078-A1
6 J / C / CEM	6H6	1984-96	REC6G1-44352-00	REC6G1-44322-02	REC6G1-44323-00		REC6G1-44315-A0	REC647-44366-00	REC90280-03024	REC6G1-W0078-A1
8 N / J / C / CEM	6G1	1984-96	REC6G1-44352-00	REC6G1-44322-02	REC6G1-44323-00		REC6G1-44315-A0	REC647-44366-00	REC90280-03024	REC6G1-W0078-A1
9.9D	6,00E+007	1984-95	REC682-44352-01	REC682-44322-00	REC682-44323-40		REC682-44315-00	REC682-44365-00	REC90280-03024	REC682-W0078-A1
9.9F, FEM, FM, MH, MS	63V	1995-00	REC63V-44352-01	REC63V-44322-00	REC63V-44323-00	REC63V-44301-00	REC93210-44398	REC647-44366-00	REC664-44338-00	REC63V-W0078-01
13.5AWH	63V	1998	REC63V-44352-01	REC63V-44322-00	REC63V-44323-00	REC63V-44301-00	REC93210-44398	REC647-44366-00	REC664-44338-00	REC63V-W0078-01
15D	6,00E+008	1984-95	REC682-44352-01	REC682-44322-00	REC682-44323-40		REC682-44315-00	REC682-44365-00	REC90280-03024	REC682-W0078-A1
15F, FEM, MH, MS	63W	1995-00	REC63V-44352-01	REC63V-44322-00	REC63V-44323-00	REC63V-44301-00	REC93210-44398	REC647-44366-00	REC664-44338-00	REC63V-W0078-01
20D, DE, DM, MLH, MSH, DW	6L3>6L39	1998-11	REC6L2-44352-00	REC6L2-44322-00			REC93210-45161	PAF25-04050004	PAF25-04000015	REC6L2-W0078-00
20C	6A9 / 6A90 / 6A91	1997-02	REC689-44352-02	REC689-W4432-01	REC689-44323-00	REC689-44311-00	REC689-44324-A0	REC689-44366-00	REC664-44338-00	REC689-W0078-A6
20CM	6A9	1992	REC689-44352-02	REC689-W4432-01	REC689-44323-00	REC689-44311-00	REC689-44324-A0	REC689-44366-00	REC664-44338-00	REC689-W0078-A6
25D	6950	2001	REC689-44352-02	REC689-W4432-01	REC689-44323-00	REC689-44311-00	REC689-44324-A0	REC689-44366-00	REC664-44338-00	REC689-W0078-A6
25		1984-85	REC689-44352-02	REC689-W4432-01	REC689-44323-00	REC689-44311-00	REC689-44324-A0	REC689-44366-00	REC664-44338-00	REC689-W0078-04
25D, N, NE, MLH, MSH, NMH	6L2>6L29	1998-10	REC6L2-44352-00	REC6L2-44322-00			REC93210-45161	PAF25-04050004	PAF25-04000015	REC6L2-W0078-00
25NMH, NW, MH	6L2A>6L2F	2011-15	REC6L2-44352-00	REC6L2-44322-00			REC93210-45161	PAF25-04050004	PAF25-04000015	REC6L2-W0078-00
25 J, JEO	6K9	1987-94	REC6H4-44352-02	REC663-44322-00	REC663-44323-00	REC663-44311-02	REC663-44315-A0	REC663-44366-00	REC90280-03024	REC6J8-W0078-A2
C25		1990-97	REC689-44352-02	REC689-W4432-01	REC689-44323-00	REC689-44311-00	REC689-44324-A0	REC689-44366-00	REC664-44338-00	REC689-W0078-A6
CV25		1990	REC689-44352-02	REC689-W4432-01	REC689-44323-00	REC689-44311-00	REC689-44324-A0	REC689-44366-00	REC664-44338-00	REC689-W0078-A6
30		1984-85	REC689-44352-02	REC689-W4432-01	REC689-44323-00	REC689-44311-00	REC689-44324-A0	REC689-44366-00	REC664-44338-00	REC689-W0078-04
30		1986	REC689-44352-02	REC689-W4432-01	REC689-44323-00	REC689-44311-00	REC689-44324-A0	REC689-44366-00	REC664-44338-00	REC689-W0078-A6
30D		1986-94	REC6H4-44352-02	REC663-44322-00	REC663-44323-00	REC663-44311-02	REC663-44315-A0	REC663-44366-00	REC90280-03024	REC682-W0078-A1
30D, DE, DMH	6J8	1986-94	REC6H4-44352-02	REC663-44322-00	REC663-44323-00	REC663-44311-02	REC663-44315-A0	REC663-44366-00	REC90280-03024	REC6J8-W0078-A2
C30		1990-92	REC689-44352-02	REC689-W4432-01	REC689-44323-00	REC689-44311-00	REC689-44324-A0	REC689-44366-00	REC664-44338-00	REC689-W0078-A6
C30		1993-97	REC6H4-44352-02	REC61N-44322-00	REC61N-44323-00	PAF25-04050001	PAF25-04050003	PAF25-04050004	REC90280-03024	REC61N-W0078-11
40		1984-87	REC6H4-44352-02	REC663-44322-00	REC663-44323-00	REC663-44311-02	REC663-44315-A0	REC663-44366-00	REC90280-03024	REC6H4-W0078-00
40		1988-94	REC6H4-44352-02	REC663-44322-00	REC663-44323-00		REC663-44315-A0	REC663-44366-00	REC90280-03024	REC6H4-W0078-00

			1	2	3	4	5	6	7	KIT
40		1995-05	REC6H3-44352-00	REC63D-44322-00	REC63D-44323-00	REC63D-44311-01	REC93210-59MG7	REC663-44366-00	REC90280-03024	REC63D-W0078-01
E40GMH	6F62	2003	REC6F5-44352-00	REC676-44322-00	REC676-44323-00-40	REC676-44311-00	REC676-44315-00	REC663-44366-00	REC90280-04M00	REC6F5-W0078-A0
40GWH	6F62	2003	REC6F5-44352-00	REC676-44322-00	REC676-44323-00-40	REC676-44311-00	REC676-44315-00	REC663-44366-00	REC90280-04M00	REC6F5-W0078-A0
C40		1990-91	REC6F5-44352-00	REC676-44322-00	REC676-44323-00-40	REC676-44311-00	REC676-44315-00	REC663-44366-00	REC90280-04M00	REC6F5-W0078-A0
C40		1992-97	REC6F5-44352-00	REC676-44322-00	REC676-44323-00-40	REC676-44311-00	REC676-44315-00	REC663-44366-00	REC90280-04M00	REC679-W0078-A1
40QE	6R6	1990	REC6F5-44352-00	REC676-44322-00	REC676-44323-00-40	REC676-44311-00	REC676-44315-00	REC663-44366-00	REC90280-04M00	REC679-W0078-A1
EK40JMH	6H95	2006	REC6F5-44352-00	REC676-44322-00	REC676-44323-00-40	REC676-44311-00	REC676-44315-00	REC663-44366-00	REC90280-04M00	REC679-W0078-A1
C40MLH	63B>63B2	2000-03	REC6H3-44352-00	REC63D-44322-00	REC63D-44323-00	REC63D-44311-01	REC93210-59MG7	REC663-44366-00	REC90280-03024	REC63D-W0078-01
C40T, TLRZ	63D>63D6	1996-03	REC6H3-44352-00	REC63D-44322-00	REC63D-44323-00	REC63D-44311-01	REC93210-59MG7	REC663-44366-00	REC90280-03024	REC63D-W0078-01
P40		1998	REC6H3-44352-00	REC63D-44322-00	REC63D-44323-00	REC63D-44311-01	REC93210-59MG7	REC663-44366-00	REC90280-03024	REC63D-W0078-01
40V, VE	63D>63D6	1996-03	REC6H3-44352-00	REC63D-44322-00	REC63D-44323-00	REC63D-44311-01	REC93210-59MG7	REC663-44366-00	REC90280-03024	REC63D-W0078-01
40V, VE, VEO, VES	63C>63C9 63CA>63CF	1997-15	REC6H3-44352-00	REC63D-44322-00	REC63D-44323-00	REC63D-44311-01	REC93210-59MG7	REC663-44366-00	REC90280-03024	REC63D-W0078-01
40V, VMH	63B>63BF	1995-15	REC6H3-44352-00	REC63D-44322-00	REC63D-44323-00	REC63D-44311-01	REC93210-59MG7	REC663-44366-00	REC90280-03024	REC63D-W0078-01
50		1984-87	REC6H4-44352-02	REC663-44322-00	REC663-44323-00	REC663-44311-02	REC663-44315-A0	REC663-44366-00	REC90280-03024	REC6H4-W0078-00
50		1988-94	REC6H4-44352-02	REC663-44322-00	REC663-44323-00	REC663-44311-02	REC663-44315-A0	REC663-44366-00	REC90280-03024	REC6H4-W0078-00
50HMD0, H	62W,63G	1995-00	REC6H3-44352-00	REC63D-44322-00	REC63D-44323-00	REC63D-44311-01	REC93210-59MG7	REC663-44366-00	REC90280-03024	REC63D-W0078-01
50H, HEM, HWH/ CS0TLR	62X>62X5	2000-03	REC6H3-44352-00	REC63D-44322-00	REC63D-44323-00	REC63D-44311-01	REC93210-59MG7	REC663-44366-00	REC90280-03024	REC63D-W0078-01
C50		1998-01	REC6H3-44352-00	REC63D-44322-00	REC63D-44323-00	REC63D-44311-01	REC93210-59MG7	REC663-44366-00	REC90280-03024	REC63D-W0078-01
PRO 50		1987	REC6H4-44352-02	REC663-44322-00	REC663-44323-00	REC663-44311-02	REC663-44315-A0	REC663-44366-00	REC90280-03024	REC6H4-W0078-00
PRO 50		1988-90	REC6H4-44352-02	REC663-44322-00	REC663-44323-00	REC663-44311-02	REC663-44315-A0	REC663-44366-00	REC90280-03024	REC6H4-W0078-00
P50		1991-93	REC6H4-44352-02	REC663-44322-00	REC663-44323-00	REC663-44311-02	REC663-44315-A0	REC663-44366-00	REC90280-03024	REC6H4-W0078-00
P50		1995-96	REC6H3-44352-00	REC689-W4432-01	REC63D-44323-00	REC63D-44311-01	REC93210-59MG7	REC663-44366-00	REC90280-03024	REC63D-W0078-01
55B, BET, BM	697	1992-00	REC6H3-44352-00	REC663-44322-00	REC663-44323-00	REC663-44311-02	REC663-44315-A0	REC663-44366-00	REC90280-03M03	REC663-W0078-01
55B, BET, BM	6970>6971	1989	REC6H3-44352-00	REC663-44322-00	REC663-44323-00	REC663-44311-02	REC663-44315-A0	REC663-44366-00	REC90280-03M03	REC663-W0078-01
60		2001-03	REC6H3-44352-00	REC663-44322-00	REC6H3-44323-00		REC6H3-44315-00	REC663-44366-00	REC90280-03M03	REC6H3-W0078-02
60		2004-05	REC688-44352-03	REC688-44322-00	REC688-44323-00	REC688-44311-01	REC688-44315-00	REC663-44366-00	REC90280-04M04	REC692-W0078-02
C60		1996-01	REC6H3-44352-00	REC663-44322-00	REC6H3-44323-00		REC6H3-44315-00	REC663-44366-00	REC90280-03M03	REC6H3-W0078-02
E60		1995-96	REC6H3-44352-00	REC663-44322-00	REC6H3-44323-00		REC6H3-44315-00	REC663-44366-00	REC90280-03M03	REC6H3-W0078-02
E-60H/ E60HMH	6K5	1997-00	REC6H3-44352-00		REC6H3-44323-00		REC6H3-44315-00	REC663-44366-00	REC90280-03M03	REC6K5-W0078-01
P60		1991	REC6H3-44352-00	REC663-44322-00	REC6H3-44323-00		REC6H3-44315-00	REC663-44366-00	REC90280-03M03	REC6H3-W0078-02
P60		1992-99	REC6H3-44352-00	REC663-44322-00	REC6H3-44323-00		REC6H3-44315-00	REC663-44366-00	REC90280-03M03	REC6H3-W0078-02
70		1984-03	REC6H3-44352-00	REC663-44322-00	REC6H3-44323-00		REC6H3-44315-00	REC663-44366-00	REC90280-03M03	REC6H3-W0078-02
70		2004-09	REC688-44352-03	REC688-44322-00	REC688-44323-00	REC688-44311-01	REC688-44315-00	REC663-44366-00	REC90280-04M04	REC692-W0078-02
C70		2000-01	REC6H3-44352-00	REC663-44322-00	REC6H3-44323-00		REC6H3-44315-00	REC663-44366-00	REC90280-03M03	REC6H3-W0078-02
C75		1994-99	REC688-44352-03	REC688-44322-00	REC688-44323-00	REC688-44311-01	REC688-44315-00	REC663-44366-00	REC90280-04M04	REC692-W0078-02
E75		1995-00	REC688-44352-03		REC688-44323-00	REC688-44311-01	REC688-44315-00	REC663-44366-00	REC90280-04M04	REC692-W0078-02
P75		1996-99	REC688-44352-03	REC688-44322-00	REC688-44323-00	REC688-44311-01	REC688-44315-00	REC663-44366-00	REC90280-04M04	REC692-W0078-02
75CETO, TLR	67P1>67P9	2003-2011	REC688-44352-03	REC688-44322-00	REC688-44323-00	REC688-44311-01	REC688-44315-00	REC663-44366-00	REC90280-04M04	REC692-W0078-02
75CETO	67PA>67PE	2012-15	REC688-44352-03	REC688-44322-00	REC688-44323-00	REC688-44311-01	REC688-44315-00	REC663-44366-00	REC90280-04M04	REC692-W0078-02
75A, AE	692>692B 692A>692C	1997-07	REC688-44352-03	REC688-44322-00	REC688-44323-00	REC688-44311-01	REC688-44315-00	REC663-44366-00	REC90280-04M04	REC692-W0078-02
80A, AEO, AEM	6H0>6H01	1997-02	REC688-44352-03	REC688-44322-00	REC688-44323-00	REC688-44311-01	REC688-44315-00	REC663-44366-00	REC90280-04M04	REC692-W0078-02
C80		1997	REC688-44352-03	REC688-44322-00	REC688-44323-00	REC688-44311-01	REC688-44315-00	REC663-44366-00	REC90280-04M04	REC692-W0078-02
85A, AED, AET	688>6882	1997-03	REC688-44352-03	REC688-44322-00	REC688-44323-00	REC688-44311-01	REC688-44315-00	REC663-44366-00	REC90280-04M04	REC692-W0078-02
85A	688	1990	REC682-44352-01	REC682-44322-00	REC682-44323-40		REC682-44315-00	REC682-44365-00	REC90280-03024	REC682-W0078-A1
C85		1989-97	REC688-44352-03	REC688-44322-00	REC688-44323-00	REC688-44311-01	REC688-44315-00	REC663-44366-00	REC90280-04M04	REC692-W0078-02
CV85		1989-91	REC688-44352-03	REC688-44322-00	REC688-44323-00	REC688-44311-01	REC688-44315-00	REC663-44366-00	REC90280-04M04	REC692-W0078-02
90AEO	6H1	1992	REC682-44352-01	REC682-44322-00	REC682-44323-40		REC682-44315-00	REC682-44365-00	REC90280-03024	REC682-W0078-A1
90A, AE, TR, TLR, FE, BET	6H1>6H39 6H1A>6H3F 6H2C>6H2J	1997-15	REC688-44352-03	REC688-44322-00	REC688-44323-00	REC688-44311-01	REC688-44315-00	REC663-44366-00	REC90280-04M04	REC692-W0078-02
B90		1997-99	REC688-44352-03	REC688-44322-00	REC688-44323-00	REC688-44311-01	REC688-44315-00	REC663-44366-00	REC90280-04M04	REC692-W0078-02
C90		1997-01	REC688-44352-03	REC688-44322-00	REC688-44323-00	REC688-44311-01	REC688-44315-00	REC663-44366-00	REC90280-04M04	REC692-W0078-02
100A/ AETO	64W	1996	REC6E5-44352-01	REC61A-44322-02	REC6E5-44323-00-40	REC61A-44311-00	REC6E5-44315-A0	REC6E5-44366-00	REC90280-04M05	REC6N6-W0078-02
100A/ TLR	64W/ 64W0	1997-01	REC6E5-44352-01	REC6E5-44322-00	REC6E5-44323-00-40	REC6E5-44311-00	REC93210-86M38	REC6E5-44366-00	REC90280-04M05	REC6N6-W0078-02
115B/ BE	6E5/ 6E50/ 6E51	1998-02	REC6E5-44352-01	REC6E5-44322-00	REC6E5-44323-00-40	REC6E5-44311-00	REC93210-86M38	REC6E5-44366-00	REC90280-04M05	REC6N6-W0078-02
115B/ BE/ BETO	6,00E+005	1993-96	REC6E5-44352-01	REC61A-44322-02	REC6E5-44323-00-40	REC61A-44311-00	REC6E5-44315-A0	REC6E5-44366-00	REC90280-04M05	REC6N6-W0078-02
115BE	6E5	1997	REC6E5-44352-01	REC6E5-44322-00	REC6E5-44323-00-40	REC6E5-44311-00	REC93210-86M38	REC6E5-44366-00	REC90280-04M05	REC6N6-W0078-02
115C	6N6 6N61	2000-02	REC6E5-44352-01	REC6E5-44322-00	REC6E5-44323-00-40	REC6E5-44311-00	REC93210-86M38	REC6E5-44366-00	REC90280-04M05	REC6N6-W0078-02
115CEO/ CETO	6N6	1993-96	REC6E5-44352-01	REC61A-44322-02	REC6E5-44323-00-40	REC61A-44311-00	REC6E5-44315-A0	REC6E5-44366-00	REC90280-04M05	REC6N6-W0078-02
115CET/ CETO/ TR/ TLR	6N6-6N69 6N6A-6N6E	1997-13	REC6E5-44352-01	REC6E5-44322-00	REC6E5-44323-00-40	REC6E5-44311-00	REC93210-86M38	REC6E5-44366-00	REC90280-04M05	REC6N6-W0078-02
115TXRZ	6N60	2001	REC6E5-44352-01	REC6E5-44322-00	REC6E5-44323-00-40	REC6E5-44311-00	REC93210-86M38	REC6E5-44366-00	REC90280-04M05	REC6N6-W0078-02
C115-115TLR	6N6/6E5	1998-00	REC6E5-44352-01	REC6E5-44322-00	REC6E5-44323-00-40	REC6E5-44311-00	REC93210-86M38	REC6E5-44366-00	REC90280-04M05	REC6N6-W0078-02
C115		1991-92	REC6E5-44352-01	REC6E5-44322-00	REC6E5-44323-00-40	REC6E5-44311-00	REC93210-86M38	REC6E5-44366-00	REC90280-04M05	REC6N6-W0078-02
C115		1993-00	REC6E5-44352-01	REC61A-44322-02	REC6E5-44323-00-40	REC61A-44311-00	REC93210-86M38	REC6E5-44366-00	REC90280-04M05	REC6N6-W0078-02
P115	62A	1993-96	REC6E5-44352-01	REC61A-44322-02	REC6E5-44323-00-40	REC61A-44311-00	REC93210-86M38	REC6E5-44366-00	REC90280-04M05	REC6N6-W0078-02
115	6N6/6E5	1984-94	REC6E5-44352-01	REC61A-44322-02	REC6E5-44323-00-40	REC6E5-44311-00	REC93210-86M38	REC6E5-44366-00	REC90280-04M05	REC6N6-W0078-02
130 BETO	6N7/ 6N70/ 6N77	1997-07	REC6E5-44352-01	REC61A-44322-02	REC6E5-44323-00-40	REC6E5-44311-00	REC93210-86M38	REC6E5-44366-00	REC90280-04M05	REC6N6-W0078-02
130TLR	6N7	2000	REC6E5-44352-01	REC61A-44322-02	REC6E5-44323-00-40	REC6E5-44311-00	REC93210-86M38	REC6E5-44366-00	REC90280-04M05	REC6N6-W0078-02
L130BETO	6N4	1993-96	REC6E5-44352-01	REC61A-44322-02	REC6E5-44323-00-40	REC61A-44311-00	REC6E5-44315-A0	REC6E5-44366-00	REC90280-04M05	REC6N6-W0078-02

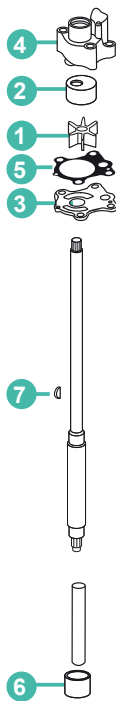







# ÁNODO

# ANODE

# ANODI

# ANODE

ZN	KG (KG)	AL	KG (KG)	OEM
CM15026	0,01	CM15026A	0,005	6E5-11325-00

100 -225 hp



ZN	KG (KG)	AL	KG (KG)	OEM
CM67C-45251-00	0,12	CM67C-45251-00A	0,047	67C-45251-00



ZN	KG (KG)	OEM
CM6U4-45251-00	0,27	6U4-45251-00

Serie TD



ZN	KG (KG)	AL	KG (KG)	OEM
CM3082523	0,03	CM689-11325-00A	0,0069	689-11325-00



ZN	KG (KG)	AL	KG (KG)	OEM
CM6G5-45251-01	0,91	CM6G5-45251-01A	0,37	6G5-45251-01

MALTA 2/4, 3.5 HP  
2B/3, A/4, A/5C, 150/200 HP



ZN	KG (KG)	AL	KG (KG)	OEM
CM6H1-45251-02	0,49	CM6H1-45251-02A	0,20	6H14525102

TOP 700



ZN	KG (KG)	AL	KG (KG)	OEM
CM68V-11325-01	0,07	CM68V-11325-01A	0,03	68V-11325-01



ZN	KG (KG)	OEM
CM41106-ZW000	0,03	41106-ZW-000

2-25 HP



ZN	KG (KG)	AL	KG (KG)	OEM
CM68T-45251-00	0,10	CM68T-45251-00A	0,04	68T-45251-00



ZN	KG (KG)	AL	KG (KG)	OEM
CM688-45251-01	0,03	CM688-45251-01A	0,01	688-45251-01

Serie 2-115  
60, 85, 115 HP



ZN	KG (KG)	AL	KG (KG)	OEM
CM6E5-45251-00	0,14	CM6E5-45251-00A	0,05	6E5-45251-00



ZN	KG (KG)	AL	KG (KG)	OEM
CM6H1-45251-01	0,56	CM6H1-45251-01A	0,23	6H1-45251-01



ZN	KG (KG)	AL	KG (KG)	OEM
CM6E0-45251-11	0,10	CM6E0-45251-11A	0,04	6E0-45251-11-00

40 hp



ZN	KG (KG)
CM825171	0,29

30-50 hp



ZN	KG (KG)	AL	KG (KG)	OEM
CM62Y-11325-00	0,02	CM62Y-11325-00A	0,01	62Y-11325-00

40-200 hp



YAMAHA

RECAMBIOS MARINOS

ZN	(KG)	OEM
CM6G1-45251-03	0,17	6G1-45251-03 6GH-45251-00 6N0-WG525-00

6C - 6D - 8C



ZN	(KG)	AL	(KG)	OEM
CM15008	0,014	CM15008A	0,006	66M-11325-00

9.9hp



ZN	(KG)	OEM
CM42121	0,03	

6 - 9.9 hp



ZN	(KG)	OEM
CM6G1-45251-02	0,03	6G1-45251-02

6 - 8 hp



ZN	(KG)	OEM
CM6E8-45251-00	0,06	6E8-45251-00

9.9 hp



ZN	(KG)	OEM
CM6U0-45251-00	1,5	6U0-45251-00



ZN	(KG)	OEM
CM6E8-45251-01	0,15	6E8-45251-02

9.9 - 15 hp



ZN	(KG)	OEM
CM6T4-45836-00	1,44	6T4-45836-00

V8



ZN	(KG)	OEM
CM6G8-45251-01	0,20	6G8-45251-00

9.9 hp



ZN	(KG)	OEM
CM6T5-45373-00	1,07	6T545373-00

130 - 260 hp



ZN	(KG)	OEM
CM66M-45371-00	0,08	66M-45371-00

9.9 hp - 4T



ZN	(KG)	OEM
CM67F-11325-00	0,06	67F-11325-00

80 - 100 hp



ZN	(KG)	OEM
CM63D-45251-01	0,54	63D-45251-01



ZN	(KG)	AL	(KG)	OEM
CM6L5-45251-02	0,06	CM6L5-45251-02A	0,03	6L5-45251-02

3,5 hp



ZN	(KG)	AL	(KG)	OEM
CM6G8-11325-00	0,02	CM6G8-11325-00A	0,004	6G8-11325-00

2.5 - 9.0 hp



ZN	KG (KG)	OEM
CM6E5-45371-10	0,23	6E5-45371-10

60 - 225 hp

ZN	KG (KG)	AL	KG (KG)	OEM
CM82795M	0,19	CM82795MA	0,07	

25, 30 hp

ZN	KG (KG)	AL	KG (KG)	OEM
CM67C-45371-00	0,21	CM67C-45371-00A	0,09	67C-45371-00

F25 - F40 - F50 - F60

ZN	KG (KG)	AL	KG (KG)	OEM
CM688-45371-02	0,48	CM688-45371-02A	0,19	688-45371-02

60 - 90 hp

ZN	KG (KG)	AL	KG (KG)	OEM
CM85007	0,01	CM85007A	0,004	688-11325-00

25-90 hp

ZN	KG (KG)	AL	KG (KG)	OEM
CM679-45251-00	0,56	CM679-45251-00A	0,213	679-45251-00

55 hp

ZN	KG (KG)	AL	KG (KG)	OEM
CM61A-45371	0,63	CM61A-45371-00A	0,25	61A-45371-00

250 hp

ZN	KG (KG)	AL	KG (KG)	OEM
CM6J9-45371-01	0,50	CM6J9-45371-01A	0,20	6J9-45371-01

150, 200 hp

ZN	KG (KG)	AL	KG (KG)	OEM
CM61N-45251-01	0,26	CM61N-45251-01A	0,10	61N-45251-01

4T, 9.9, 15F, 25 hp

ZN	KG (KG)	AL	KG (KG)	OEM
CM6K1-45371-02	0,50	CM6K1-45371-02A	0,21	6J9-45371-02

150, 200 hp

CONTRAROTACIÓN  
COUNTERROTATION  
CONTROROTANTE  
CONTRE ROTATION

ZN	KG (KG)	AL	KG (KG)	OEM
CM664-45371-01	0,28	CM664-45371-01A	0,11	664-45371-01A

20, 25, 30 hp

ZN	KG (KG)	AL	KG (KG)	OEM
CM69L-45371-00	0,52	CM69L-45371-00A	0,21	69L-45371-00

ZN	 (KG)	OEM
CM6T5-45371-00	0,52	6T5-45371-00



130 - 160 hp



ZN	 (KG)	AL	 (KG)	OEM
CM6AW-45373-00	1,09	CM6AW-45373-00A	0,42	6AW-45373-00

300 - 350 hp



ZN	 (KG)	AL	 (KG)	OEM
REC6E5-45371-01	0,42	CM6E5-45371-01A	0,17	6E5-45371-01

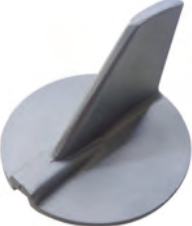

115 - 225 HP (V-4 - V6)



ZN	 (KG)	AL	 (KG)	OEM
CM6AW-45251-00	0,66	CM6AW-45251-00A	0,25	6AW-45251-00

200 - 350 hp





ZN	 (KG)	AL	 (KG)	OEM
CM6K1-45371-00	0,42	CM6K1-45371-00A	0,17	6K1-45371-00

115 - 225 HP (V-4 - V6)

CONTRAROTACIÓN  
COUNTERROTATION  
CONTROROTANTE  
CONTRE ROTATION



ZN	 (KG)	AL	 (KG)	OEM
CM6AW-45619-00	0,27	CM6AW-45619-00A	0,103	6AW-45619-00

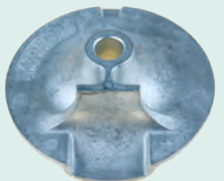

300 - 350 hp



ZN	 (KG)	AL	 (KG)	OEM
CM63P-11325-11	0,02	CM63P-11325-11A	0,008	63P-11325-11



150 - 300 hp



ZN	 (KG)	AL	 (KG)	OEM
CM6BL-11325-00	0,02	CM6BL-11325-00A	0,007	6BL-11325-00

BLOC  
F20 / T,F25



ZN	 (KG)	AL	 (KG)	OEM
CM67F-11325-01	0,044	CM67F-11325-01A	0,017	67F-11325-01



75 - 350 hp



ZN	 (KG)	OEM
CM61A-11325-00	0,02	61A-11325-00



BLOC  
V6



ZN	 (KG)	AL	 (KG)	OEM
CM67F-45371-00	0,407	CM67F-45371-00A	0,156	67F-45371-00



50 - 225 hp



ZN	 (KG)	AL	 (KG)	OEM
CM63P-11325-01	0,022	CM63P-11325-01A	0,008	63P-11325-00 63P-11325-01

F150 - F350 (2004+)



ZN	 (KG)	AL	 (KG)	OEM
CM68T-11325-00	0,011	CM68T-11325-00A	0,004	68T-11325-00

BLOC  
6 - 300 hp





KITS DE ÁNODOS

ANODES KIT

KIT ANODI

KIT ANODES

AL	MG
CMY150KITA	CMY150KITM
150 - 200 hp	



**new**

AL	MG
CMY200250KITA	CMY200250KITM
200 - 250 hp	



**new**

AL	MG
CMY150CRKITA	CMY150CRKITM
150, 200 hp	
<b>CONTRAROTACIÓN</b> <b>COUNTERROTATION</b> <b>CONTROROTANTE</b> <b>CONTRE ROTATION</b>	



**new**

AL	MG
CMYHP200300KITA	CMY200300KITM
200 - 300 hp	



**new**

AL	MG
CMY300350KITA	CMY300350KITM
300 - 350 hp	



**new**

AL	MG
CMY4060KITA	CMY4060KITM
4T 40 - 60 hp	



**new**

AL	MG
CMY300350XPKITA	CMY300350XPKITM
300 - 350 hp	



**new**

AL	MG
CMY6090KITA	CMY6090KITM
60 - 90 hp	



**new**

AL	MG
CMY4050KITA	CMY4050KITM
40 - 50 hp	



**new**

AL	MG
CMY80100KITA	CMY80100KITM
80 - 100 hp	



**new**

# ÁNODO

# ANODE

# ANODI

# ANODE



ZN	OEM	KG
TEN01109	677-45251-00	0,02

2 - 25 hp

ZN	OEM	KG
TEN01132	67C-45251-00 63D-45251-10	0,12

T25, F30, F40, F50, F60, hp

ZN	OEM	KG
TEN01110	688-45251-01	0,04

60 - 85 - 115 hp

ZN	OEM	KG
TEN01142	68T-45251-00	0,10

F8C - 68T (2000) - 4T

ZN	OEM	KG
TEN01111		0,210

Serie 2 - 115 hp  
70 - 85 hp

ZN	OEM	KG
TEN01147	688-11325-00	0,01

25 - 90 hp

ZN	OEM	KG
TEN01165	63P-11325-21-00	0,03

ZN	OEM	KG
TEN01152	6E5-11325-00	0,01

100 - 225 hp

ZN	OEM	KG
TEN01148	6G8-11325-00	0,01

2.5 - 9 hp

ZN	OEM	KG
TEN01146	67F-11325-00	0,07

80 - 100 hp

ZN	OEM	KG
TEN01149	62Y-11325-00	0,02

40- 200 hp

ZN	OEM	KG
TEN01146-1	67F-11325-01	0,05

80 - 100 hp

ZN	OEM	KG
TEN01150	6J8-11325-00	0,02

20- 25 hp

ZN	OEM	KG
TEN01151	66M-11325-00	0,01

9.9 hp

ZN	OEM	KG
TEN01168	61A-11325-00	0,02

ZN	KG	AL	KG	OEM
TEN01135	0,27	TEN01135A	0,11	61N-45251-01

4T - 9,9 - 15F - 25 hp

YAMAHA

RECAMBIOS MARINOS

ZN	OEM	KG (kg)
TEN01137	6G8-45251-00	0,20

9.9 hp

ZN	OEM	KG (kg)
TEN01118	6G1-45251-03	0,175

6C - 6D - 8C HP

ZN	OEM	KG (kg)
TEN01138	6AV-45251-00 6V3-45251-01	0,28

TD

ZN	OEM	KG (kg)
TEN01122	6T4-45836-00	1,49

V8

ZN	KG (kg)	AL	KG (kg)	OEM
TEN01123	0,10	TEN01123A	0,04	6E0-45251-11-00 65W-45251-00

40 hp

ZN	KG (kg)	AL	KG (kg)	OEM
TEN01100	0,21	TEN01100A	0,08	664-45371-01

20 - 25 - 30 HP

ZN	OEM	KG (kg)
TEN01105	6E5-45251-00	0,15

115 - 225 hp

ZN	KG (kg)	AL	KG (kg)	OEM
TEN01101	0,46	TEN01101A	0,17	679-45371-00

55 HP 10x1,25

ZN	OEM	KG (kg)
TEN01106	6E8-45251-00	0,045

9.9 hp

ZN	OEM	KG (kg)
TEN01102		0,62

55 HP 10x1,25

ZN	OEM	KG (kg)
TEN01116	6E8-45251-02	0,14

9.9 - 15 hp

ZN	KG (kg)	AL	KG (kg)	OEM
TEN01103	0,39	TEN01103A	0,15	6L6-45371-00

115 - 225 HP  
V4 - V6

ZN	OEM	KG (kg)
TEN01136	66M-45371-00	0,09

9.9 4T hp

ZN	KG (kg)	AL	KG (kg)	OEM
TEN01104	0,43	TEN01104A	0,17	688-45371-02

60 - 90 hp

ZN	OEM	KG (kg)
TEN01153	6E5-45371-00	0,337

60 - 225 hp

ZN	KG (kg)	AL	KG (kg)	OEM
TEN01104	0,43	TEN01104A	0,17	688-45371-02

60 - 90 hp

ZN	OEM	KG (kg)
TEN01119	6T5-45371-00	0,58

130 - 205 - 230 - 260 hp

ZN	OEM	KG (kg)
TEN01131	63D-45251-00 63D-45251-01	0,57

H.C. 48

ZN	KG (kg)	AL	KG (kg)	OEM
TEN01124	0,68	TEN01124AL	0,27	61A-45371-00

250A hp

ZN	KG (kg)	AL	KG (kg)	OEM
TEN01154	0,69	TEN01154AL	0,69	6AH-45251-00

ZN	OEM	KG (kg)
TEN01130		0,27

25 - 30 hp

ZN	OEM	KG (kg)
TEN01129	6E5-45251-00	0,24

75 HP - XR6

ZN	KG (kg)	AL	KG (kg)	OEM	
TEN01133	DX220	0,63	TEN01133AL	0,26	6J9-45371-01
TEN01134	SX220	0,63			6K1-45371-02

150 - 200 HP

ZN	OEM	KG (kg)
TEN01157	6U0-45251-00	1,50

TD

ZN	OEM	KG (kg)
TEN01140	67F-45371-00	0,40

80 - 100 HP 4T

ZN	OEM	KG (kg)
TEN01107		0,03

9.9 hp

ZN	KG (kg)	AL	KG (kg)	OEM
TEN01141	0,22	TEN01141AL	0,09	67F-45371-00

F40 - F50 - F60 4T

ZN	OEM	KG (kg)
TEN01108	6G1-45251-02	0,04

6 - 8 hp

ZN	OEM	KG (kg)
TEN01143	6J9-45371-00	0,56

150 - 225 HP

ZN	OEM	KG (kg)
TEN01169	6AW-45619-00	0,30



ZN	(KG)	AL	(KG)	OEM
TEN01155	1,05	TEN01155AL	0,4	6AW-45373-00



ZN	OEM	(KG)
TEN01112-1	6AW-45251	0,65

200 - 350 hp



ZN	OEM	(KG)
TEN01158	6U4-45373-00	0,33



ZN	OEM	(KG)
TEN01162	682-11325-00	0,02



ZN	OEM	(KG)
TEN01117	6L5-45251-02	0,07

Malta 3,5 HP  
+ 2B - 3A - 4A - 5C



ZN	OEM	(KG)
TEN01164	63P-11325-11-00	0,02



ZN	OEM	(KG)
TEN01166	676-11325-00	0,03



ZN	OEM	Ø (mm)	(KG)
TEN01127	676-45251-00	20	0,02
TEN01128	682-45251-00	24	0,02



ZN	OEM	(KG)
TEN01167	63P-11325-01-00	0,02



ZN	OEM	(KG)
TEN01161	6BL-11325-00	0,02



ZN	(KG)	AL	(KG)	OEM
TEN01115	0,46	TEN01115AL	0,18	6H1-45251-02

TOP 700



ZN	OEM	(KG)
TEN01163	68T-11325-00	0,02



ZN	OEM	(KG)
TEN01125	6H1-45251-01	1,20

150 - 200 hp



ZN	(KG)	AL	(KG)	OEM
TEN01112	0,90	TEN01112AL	0,36	6G5-45251-01 6G5-45251-02



ZN	OEM	(KG)
TEN01120	6T5-45373-00	0,77

130 - 205 - 230 - 260 hp



ZN	OEM	(KG)
TEN01113	6H1-45251-03	0,55

60 - 90 hp



ZN	OEM	KG (kg)
TEN01126		0,29

30 - 40 hp



ZN	OEM	KG (kg)
TEN01159	6U4-45251-00	0,60



ZN	OEM	KG (kg)
TEN01121	689-11325-00	0,02

W30 - W8 25/2/3 hp



ZN	OEM	KG (kg)
TEN01160T	N51-11325-01	0,60



ZN	KG (kg)	AL	KG (kg)	OEM
TEN01156	0,03	TEN01156AL	0,02	68V-11325-02



ZN	KG (kg)	AL	KG (kg)	OEM
TEN01156-1	0,07	TEN01156/1AL	0,03	68V-11325-01



ZN	OEM	KG (kg)	Ø (mm)	(mm)	
TEN01114		0,09	20	39	M8



ZN	OEM	KG (kg)
TEN01139	6T5-45251-00	0,35



ZN	OEM	KG (kg)	Ø (mm)	(mm)
TEN01170	6AW-1132S-00	0,035	14	40
TEN01171	6AQ-1132N-00	0,030	14	38

300 - 350 hp



**new**

ZN	OEM	KG (kg)	Ø (mm)	(mm)
TEN01172	6AW-1132R-00	0,022	16	20

300 - 350 hp



**new**

ZN	OEM	KG (kg)	Ø (mm)	(mm)
TEN01173	6AW-1132L-00	0,026	19	15

300 - 350 hp



**new**

ZN	OEM	KG (kg)
TEN01174	6AW-1132U-00	0,06

300 - 350 hp



**new**

ZN	OEM	KG (kg)
TEN01175	6AW-1132T-00	0,06

300 - 350 hp



**new**

ZN	OEM	KG (kg)
TEN01176	6AW-1132M-00	0,12

300 - 350 hp



**new**

ZN	OEM	 (kg)
TEN01177	6AW-1132P-00	0,034



300 - 350 hp



**new**

ZN	OEM	 (kg)
TEN01145	69L-45371-00	0,66



ZN	 (kg)	AL	 (kg)	OEM
TEN01144	0,41	TEN01144AL		6K1-45371-00



**KITS DE ÁNODOS      ANODES KIT      KIT DE ANODI      KIT ANODES**

ZN	 (kg)
TENKITYAMAHA150-200	

150 - 200 hp



**new**

ZN	 (kg)
TENKITYAMAHA200-300	

200 - 300 hp



**new**

ZN	 (kg)
TENKITYAMAHA150-200C	

150, 200 hp

CONTRAROTACIÓN  
COUNTERROTATION  
CONTROROTANTE  
CONTRE ROTATION



**new**

ZN	 (kg)
TENKITYAMAHA40-60	

40 - 60 hp



**new**

ZN	 (kg)
TENKITYAMAHA200-250	

200 - 250 hp



**new**

ZN	 (kg)
TENKITYAMAHA60-90	

60 - 90 hp



**new**

**TAPA DE ÁNODO (66M)      COVER ANODE (66M)      COPERCHIO ANODO (66M)      COUVERCLE DU ANODE (66M)**

REF	OEM
PAF15-07010011	66M-11327-00-94



**new**

GUÍA DE ÁNODOS

ANODES APPLICATION

GUIDA ANODI

GUIDE DES ANODES

	TECNOSEAL		CANADA METAL	
	OEM	ZN AL	ZN	AL
<b>CILINDRO   CYLINDER   CILINDRO   MOTEURS</b>				
F2.5A, 2B, 3A, F4A, 4A, 5C (1989+), F4B, F5A, F6C	6L5-45251-03	TEN01117		CM6L5-45251-02 CM6L5-45251-02A
4A, 5C (-1989), F8A/B, F9.9A/B	677-45251-00	TEN01109		CM43107M
4A, 5C, F8A/B/, 6C/D, 8C, F9.9A/B(1989+), 9.9D, 15/6C/D, 8C (1990+)	6E0-45251-12	TEN01123	TEN01123AL	CM6E0-45251-11 CM6E0-45251-11A
6C/D, 8C (-1989)	6GH-45251-00	TEN01118		CM6G1-45251-03
F6A/B, F8C, F9.9F, F9.9J	6N0-WG525-00	TEN01108		CM6G1-45251-02
F8A/B, 9.9D, F9.9B, 15D, F9.9A(-1994)	68T-45251-00	TEN01142		CM68T-45251-00 CM68T-45251-00A
F9.9A, FT9.9A (1994+)	6E8-45251-02	TEN01116		CM6E8-45251-01
FT8, 9.9F, F9.9C, FT9.9D, FT9.9G, FT9.9L, 15F, F15A, F20A, F25A, 25B/V, F25D, 30G/H, 40V/X, F30A, F40A/B/C, F50A/F, 50H, FT25B/C (2000+)	6G8-45251-01	TEN01137		CM6G8-45251-01
F15C, F20B	61N-45251-01	TEN01135	TEN01135AL	CM61N-45251-01 CM61N-45251-01A
FT25F, F30B, F40F, F60A/C, FT60B, 40V/X, 50H, F40A, F50A/B(-1999), F50H, F60F	6AH-45251-00	TEN01154	TEN01154AL	
F25G	67C-45251-00	TEN01132		CM67C-45251-00
F50H, F60F, FT50J, FT60G	6G8-45251-01	TEN01148		CM6G8-11325-00
F(L)300A, F(L)350A	65W-45251-00	TEN01123	TEN01123AL	CM6E0-45251-11 CM6E0-45251-11A
	6AW-45373-00	TEN01155	TEN01155AL	CM6AW-45373-00 CM6AW-45373-00A
<b>TRIM</b>				
F9.9C, F15A	66M-45371-00	TEN01136		CM66M-45371-00
40Q, 50G, 55B, PRO50	679-45371-00	TEN01101	TEN01101AL	
20C/D, 25D/N, 30A/D, 40H/V/X, 50D/H, F40A, F45A, F50A(-2000)	664-45371-01	TEN01100	TEN01100AL	CM664-45371-01 CM664-45371-01A
FT25B/C, F30A, FT25F, F25G, F30B, F40F, F40A/B/C, F50A/F, F50H, F60A/C, F60F	67C-45371-00	TEN01141	TEN01141AL	CM67C-45371-00 CM67C-45371-00A
60F, 70B, 75A/C, PRO75, 80A, 85A, 90A, FT50B(-2000), FTC/G, FT50J, FT60B/D, FT60G, F70A, F80A/B, F100A/D	67F-45371-00	TEN01104	TEN01104AL	CM688-45371-02 CM688-45371-02A
100A, 115A/B/C, 130B, 140A/B, F100B/F, F115A/B, 150A, 175A, 200A, PROV100	6E5-45371-01	TEN01103	TEN01103AL	REC6E5-45371-01 CM6E5-45371-01A
150A, 175A, 200A(1998+), 150C/F, 175B/D, 200B/F/G, 225A/B/D/F, PROV200, F150A, Z150P/Q, Z175G/H, Z200N, F200F, F(L)200G	6J9-45371-01	TEN01133	TEN01133AL	CM6J9-45371-01 CM6J9-45371-01A
150A, 175A, 200A	6K1-45371-00	TEN01144	TEN01144AL	CM6K1-45371-00 CM6K1-45371-00A
LF150A, L150C/F, L200B/F, LZ150P, LZ200N	6K1-45371-02	TEN01134		CM6K1-45371-02 CM6K1-45371-02A
FL115A, FL115B, L130B, L140B	6L6-45371-00	TEN01103		REC6E5-45371-01 CM6E5-45371-01A
(L)225C/G, (L)250A/B, F(L)200A, F(L)200C, F(L)225A, F(L)225B, F(L)250A, F(L)250B, F(L)225F, F(L)250C, F(L)300B	61A-45371-00	TEN01124	TEN01124AL	CM61A-45371 CM61A-45371-00A
Z200P, (L)Z250D/F, (L)Z300A	69L-45371-00	TEN01145		CM69L-45371-00 CM69L-45371-00A
<b>BRACKET</b>				
FT8D, FT9.9D, F15A/C, F20A/B, F25A/G(PT model), FT25B, F30A, 30D, F40B/C, 40X/V, FT50C, 50H, F60A, FT60B, F70A	65W-45251-00	TEN01123	TEN01123AL	CM6E0-45251-11 CM6E0-45251-11A
25B/Q, 40H, 50D/G, 55B, 60F, 70B, 75A/C, 80A, 85A, 90A, F80A/B, F100A/D, F(L)115B, PRO50/75 (1990+)	6H1-45251-03	TEN01115	TEN01115AL	CM6H1-45251-02 CM6H1-45251-02A
40H, 50D, 60F, 70B, 80A, 90A(1989+)	99999-03935	TEN01113		CM6H1-45251-01
40H, 50D, 60F, 70B, 80A, 90A(-1989)	688-45251-01	TEN01110		CM688-45251-01 CM688-45251-01A
25B, FT25B, F30A, 40V, F40A/B, F45A, FT50A/B, 50G/H, PRO50, 55B, 60F, 70B	663-45251-00	TEN01110		CM688-45251-01 CM688-45251-01A
40V, F40A, F45A, 50H, F50A, FT50B	63D-45251-01	TEN01131		CM63D-45251-01 CM63D-45251-01A
115A, 140A, 150A, 175A, 200A, 220A	6E5-45251-00	TEN01105		CM6E5-45251-00 CM6E5-45251-00A
100A, 115B/C, F(L)115A, (L)130B, (L)140B	6G5-45251-02	TEN01112	TEN01112AL	CM6G5-45251-01 CM6G5-45251-01A
PROV100, 150, 200, Vmax	6AW-45251-00	TEN01112-1		CM6AW-45251-00 CM6AW-45251-00A
(L)F150A, (L)150A/C/F, 175A/B/D/F	6AW-45251-00	TEN01112-1		CM6AW-45251-00 CM6AW-45251-00A
(L)200A/B/F/G, (L)225A/B/C/D/G, (L)250A/B	6AW-45251-00	TEN01112-1		CM6AW-45251-00 CM6AW-45251-00A
(L)Z150P/Q, Z175G/H/(L), Z200N/P	6AW-45251-00	TEN01112-1		CM6AW-45251-00 CM6AW-45251-00A
Z250D/F, F(L)200A, F200B, F(L)200C	6AW-45251-00	TEN01112-1		CM6AW-45251-00 CM6AW-45251-00A
F(L)225A, F(L)225B, F225C, F(L)250A	6AW-45251-00	TEN01112-1		CM6AW-45251-00 CM6AW-45251-00A
F(L)250B, (L)Z300A, F(L)300A, F(L)350A	6AW-45251-00	TEN01112-1		CM6AW-45251-00 CM6AW-45251-00A
F(L)225F, F(L)250D, F(L)300B	6AW-45251-00	TEN01112-1		CM6AW-45251-00 CM6AW-45251-00A
F(L)200F, F(L)200G	6AW-45251-00	TEN01112-1		CM6AW-45251-00 CM6AW-45251-00A
<b>F300A, F350A (V8)</b>				
TAPA TERMOSTATO   THERMOSTAT COVER	6AW-1132R-00	TEN01172		
COPERCHIO TERMOSTATO   COUVERCLE DU THERMOSTAT				
PARA REGULADOR   FOR REGULATOR   PER REGOLATORE   POUR REGULATEUR	6E5-11325-00	TEN01152		CM15026 CM15026A
BLOQUE   BLOCK   BLOCCO   MOTEUR	6AW-1132P-00	TEN01177		
BLOQUE   BLOCK   BLOCCO   BLOQUE	63P-11325-01	TEN01167		CM63P-11325-01
TAPA ESCAPE   EXHAUST COVER   COPERCHIO SCARICO   PLAQUE D'ECHAPPEMENT	6AW-1132M-00	TEN01176		
ESCAPE   EXHAUST   SCARICO   ECHAPPEMENT	99999-03946	TEN01171		
ESCAPE   EXHAUST   SCARICO   ECHAPPEMENT	6AW-1132L-00	TEN01173		
PLACA ESCAPE   EXHAUST PLATE   PIASTRA SCARICO   PLAQUE D'ECHAPPEMENT	6AW-1132T-00	TEN01175		
PLACA ESCAPE   EXHAUST PLATE   PIASTRA SCARICO   PLAQUE D'ECHAPPEMENT	6AW-1132S-00	TEN01170		
ANODO PLACA ESCAPE	63P-11325-11	TEN01164		CM63P-11325-11
<b>COLAS (DIESEL)   STERN DRIVE (DIESEL)   PIEDI (DIESEL)   EMBASE (DIESEL)</b>				
Intermedio   Intermediate   Intermedio   Intermediaire - ME422	6U0-45251-00	TEN01157		CM6U0-45251-00
TRP Drive (Trasero   Rear   Posteriore   Arrière) - ME422	6U4-45251-00	TEN01159		CM6U4-45251-00
TRP Drive (Frontal   Front   Anteriore   Avant) - ME422	6U4-45373-00	TEN01158		



# PARTES DEL MOTOR ENGINE PARTS

# PARTI MOTORE PIECES MOTEUR

DESPIECE MOTOR  
DE 4 TIEMPOS

ENGINE PARTS  
4 STROKES

PARTI MOTORI  
4 TEMPI

PIECES MOTEURS  
DE 4 TEMPS

4T F2.5 AMH/MLH/MSH/MHA (2003+)  
STROKES

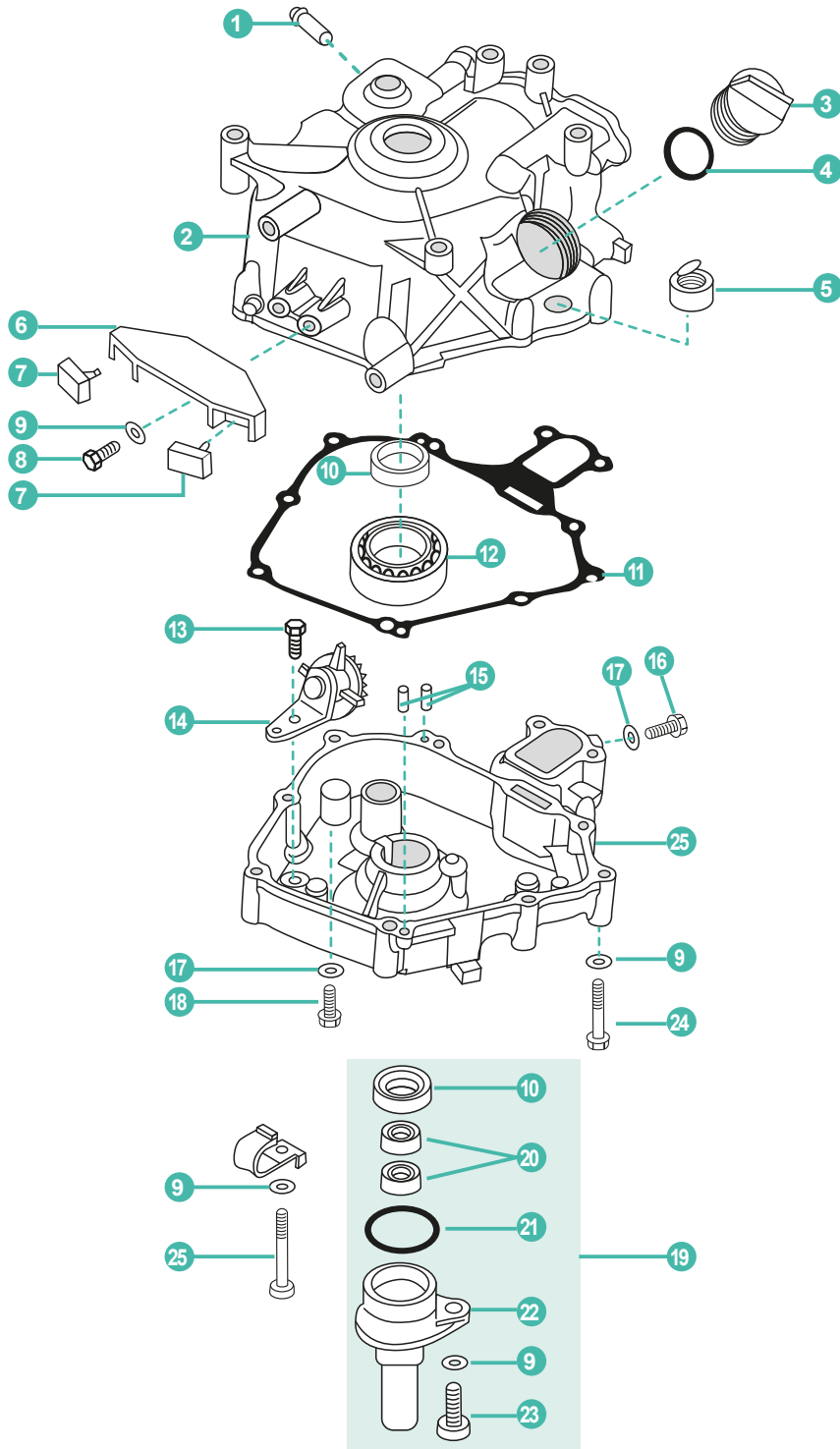

YAMAHA

RECAMBIOS  
MARINOS

	REF	OEM					UN.
1	PAT15-04010202	6H1-14485-00	PIPA DE AGUA	PIPE, WATER	TUBO	RACCORD TUYAU D'EAU	1
2	PAF2.6-04010100	69M-E1311-00-1	CARCASA MOTOR	CRANK CASE	COPERCHIO MOTORE	VILEBREQUIN	1
3	PAF15-07050004	69M-E5363-00	TAPÓN ACEITE	PLUG, OIL	TAPPO OLIO	BOUCHON REMPLISSAGE D'HUILE	1
4	PAJASOF40431-025	93210-24M79	ARO TÓRICO	O-RING	O-RING	JOINT TORIQUE	1
5	PAF2.6-04010102	69M-15361-00	INDICADOR NIVEL	GAUGE, LEVEL	INDICATORE LIVELLO	JAUGE DE NIVEAU	1
6	PAF2.6-04000008	69M-G2743-00	SOPORTE MOTOR	BRACKET, DAMPER	SUPPORTO MOTORE	SUPPORT	1
7	PAF2.6-04000009	6G8-44532-00	GOMA SOPORTE	RUBBER BLOCK, DAMPER	GOMMA SUPPORTO	SILENT BLOC	2
8	PAGB/T5783-M6X20	97095-06020	TORNILLO	SCREW	VITE	VIS	2
9	PAGB/T97.1-6	92995-06600	ARANDELA	WASHER	RONDELLA	RONDELLE	11
10	PAF2.6-04010001	93102-20108	RETÉN	OIL SEAL	PARAOLIO	JOINT	2
11	PAF2.6-04000004	69M-11351-A0	JUNTA CÁRTER	CRANK CASE COMPLEX GASKET	GUARNIZIONE COPPA L'OLLIO	JOINT DE CARTER	1
12	PAGB/T276-62/22/P6	93306-272Y2	RODAMIENTO	BALL BEARING	CUSCINETTO	ROULEMENT À BILLE	1
13	PAGB/T5783-M6X12	95817-06012	TORNILLO	SCREW	VITE	VIS	1
14	PAF2.6-04050100	69M-E3102-00	PIÑÓN	GEAR UNIT ASSY	PIGNONE	PIGNON	1
15	PAF15-00000013	93604-12M07	PIN	PIN	SPINOTTO	GOUPILLE FENDUE	2
16	PAGB/T5783-M8X14	97095-08014	TORNILLO	SCREW	VITE	VIS	1
17	PAF4-04000006	90201-08818-00	ARANDELA	WASHER	RONDELLA	RONDELLE	2
18	PAF4-04000001	90105-08M76	TORNILLO DRENAJE	BOLT, DISCHARGING OIL	VITE DRENAGGIO	VIS DE VIDANGE	1
19	PAF2.6-04060000	69M-E5396-00-5B	RETÉN Y CUERPO, COMPLETO	OIL SEAL SHELL ASSY	GUARNIZIONE E CORPO COMPLETO	LOGEMENT JOINT D'HUILE, COMPLETE	1
20	PAF2.6-04060002	93210-09004	RETÉN	OIL SEAL	PARAOLIO	JOINT	2
21	PAF4-04060002	93210-35537	ARO TÓRICO	O RING	O-RING	JOINT TORIQUE	1
22	PAF2.6-04060001	69M-E5396-00	CUERPO DEL RETÉN	SHELL, OIL SEAL	GUARNIZIONE CORPO	LOGEMENT JOINT D'HUILE	1
23	PAGB/T5783-M5X12	90465-08M99	TORNILLO	SCREW	VITE	VIS	1
24	PAGB/T5783-M5X12	97013-06045	TORNILLO	SCREW	VITE	VIS	8
25	PAF2.6-04050001	69M-E5111-00-1S	CARTER	CRANKCASE COVER	CARTER	CARTER	1



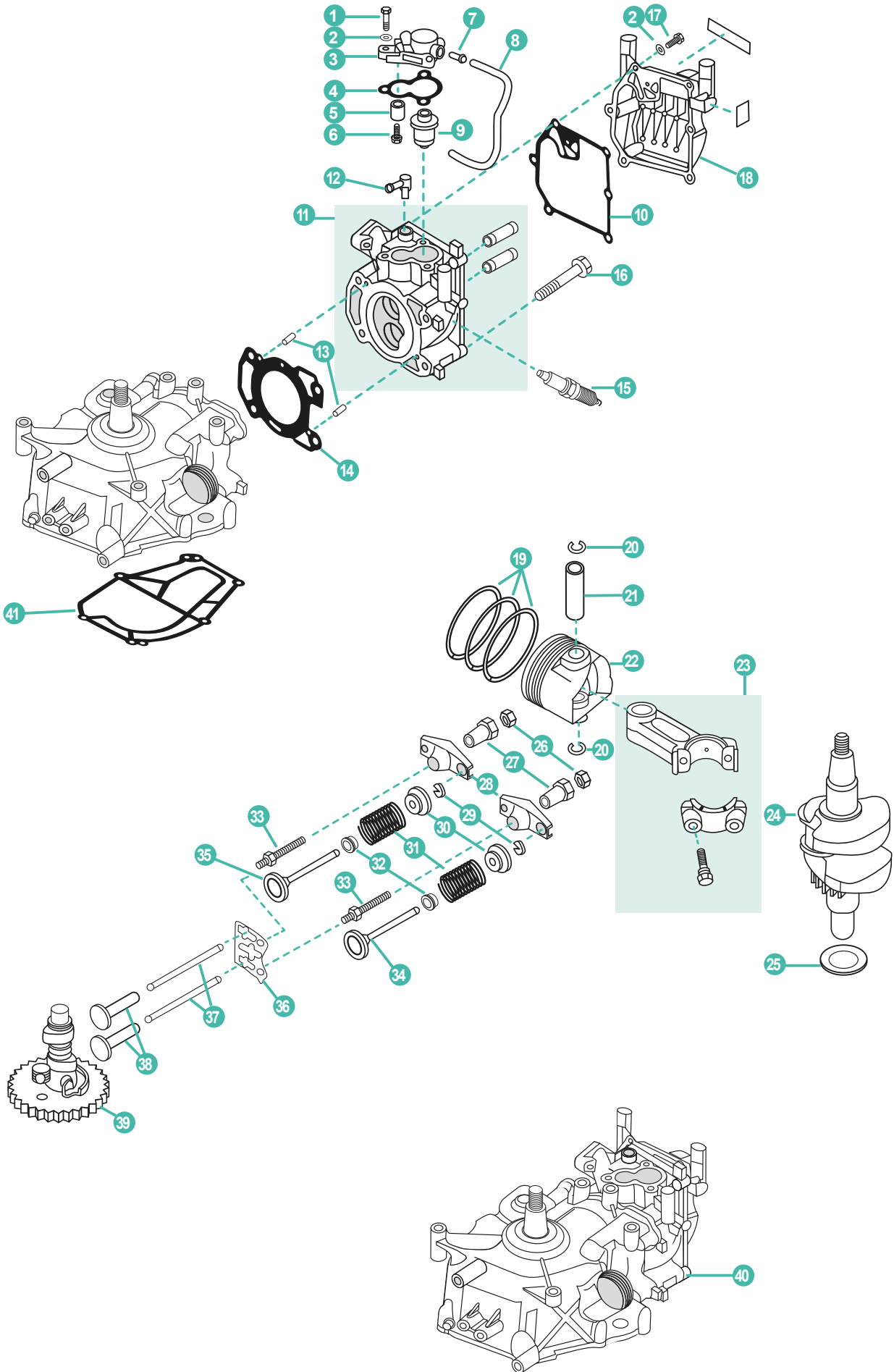

	REF	OEM				UN.	
1	PAGB/T5783-M6X20	97095-06020	TORNILLO	SCREW	VITE	VIS	3
2	PAGB/T97.1-6	92995-06600	ARANDELA	WASHER	RONDELLA	RONDELLE	9
3	PAF2.6-04000501	69M-E2413-00-1S	TAPA TERMOSTATO	COVER, THERMOSTAT	COPERCHIO TERMOSTATO	COUVERCLE THERMOSTAT	1
4	PAF4-04000011	68D-E2414-A0	JUNTA TAPA TERMOSTATO	GASKET, THERMOSTAT COVER	GUARNIZIONE COPERCHIO TERMOSTATO	JOINT COUVERCLE DE THERMOSTAT	1
5	PAF4-04070003	68D-E1325-00	ÁNODO	ANODE	ANODO	ANODE	1
6	PAGB/T818-M5X25	97880-05025	TORNILLO	SCREW	VITE	VIS	1
7	PAF4-04010102	650-24378-00	PIPA	PIPE, JOINT	TUBO	RACCORD TUYAU D'EAU	1
8	PAF2.6-04000007	90445-09808	TUBO DE AGUA	WATER TUBE	TUBO DELL'ACQUA	DURITE D'EAU	1
9	REC6AH-12411-00	69M-12411-01	TERMOSTATO	THERMOSTAT	TERMOSTATO	THERMOSTAT	1
10	PAF2.6-04000005	69M-11193-A0	JUNTA TAPA BALANCINES	GASKET, CYLINDER COVER	GUARNIZIONE COPERCHIO PUNTERIE	JOINT DE CACHE CULBUTEUR	1
11	PAF2.6-04040100	69M-E1111-00-1S	CULATA COMPLETA	CYLINDER HEAD ASSY	TESTATA COMPLETA	CULASSE COMPLETE	1
12	PAF15-04000005	676-11372-00	NIPLE	NIPPLE	TUBO	RACCORD D'EAU	1
13	PAF15-00000013	93604-12M07	PIN	PIN, DOWEL	SPINOTTO	GOUPILLE FENDUE	2
14	PAF2.6-04000001	69M-11181-00	JUNTA CULATA	GASKET, CYLINDER HEAD	GUARNIZIONE TESTATA	JOINT DE CULASSE	1
15	NGKBR6HS	94702-00248	BUJÍA F2.5A	SPARK PLUG F2.5A	CANDELA F2.5A	BOUGIE F2.5A	1
	NGKCR6HSB	94702-00372	BUJÍA F2.5B	SPARK PLUG F2.5B	CANDELA F2.5B	BOUGIE F2.5B	1
16	PAF4-04000034	90105-08M36	TORNILLO	SCREW	VITE	VIS	4
17	PAGB/T5783-M6X16	90105-06039	TORNILLO	SCREW	VITE	VIS	6
18	PAF2.6-04000006	69M-E1191-00-1S	TAPA BALANCINES	COVER, CYLINDER HEAD	COPERCHIO PUNTERIE	CACHE CULBUTEUR	1
19	REC69M-E1603-01	69M-E1603-01	KIT SEGMENTOS	PISTON RING KIT	KIT FASCIA	KIT DE SEGMENTS	1
20	PAF2.6-04020006	93450-13130	CIRCLIP	CIRCLIP	CIRCLIP	CIRCLIP	2
21	PAF2.6-04020005	69M-E1633-00	PIN, PISTÓN	PIN, PISTON	SPINOTTO PISTONE	AXE DE PISTON	1
22	PAF2.6-04020001	69M-E1631-01-96	PISTÓN	PISTON	PISTONE	PISTON	1
23	PAF2.6-04020100	69M-11650-00	BIELA	ROD, CONNECTING	BIELLA	BIELLE	1
24	PAF2.6-04030000	69M-11400-00	CIGÜEÑAL	CRANK ASSY	ALBERO MOTORE	VILEBREQUIN	1
25	PAF2.6-04000003	90201-23008	ARANDELA	WASHER	RONDELLA	RONDELLE	1
26	PA166F-010011	7FK-12158-00	TUERCA	LOCK NUT	DADO	ÉCROU	2
27	PA166F-010010	7FK-12165-00	TUERCA BALANCÍN	PIVOT, ROCKER ARM	DADO BILANCERE	PIVOT CULBUTEUR	2
28	PA166F-010009	67D-12151-00	BALANCÍN	ARM, VALVE ROCKER	BILANCERE	CULBUTEUR	2
29	PAF8-05030007	7NJ-12118-00	SEGURO DE VÁLVULA	CLAMP, VALVE	BLOCCAGGIO DI VALVOLA	CLAVETTE DE SOUPAPE	2
30	PAF8-05030006	7NJ-12117-00	RETÉN DE RESORTE	SPRING, VALVE RETAINER	VALVOLA DI RITEGNO	JOINT DE RESSORT	2
31	PAF4-04080008	68D-E2113-00	MUELLE DE VÁLVULA	SPRING, VALVE STEM	MOLLA DI VALVOLA	RESSORT DE SOUPAPE	2
32	PA166F-010003	51Y-12119-00	RETÉN DE VÁLVULA	SEAT, VALVE STEM	TENUTA	JOINT QUEUE DE SOUPAPE	2
33	PA166F-010008	67D-12157-00	TORNILLO BALANCÍN	BOLT, ROCKER ARM	VITE PUNTERIE	VIS DE BRAS A BASCULE	2
34	PA166F-010001	67D-12111-00	VÁLVULA ADMISIÓN	VALVE, INTAKE	VALVOLA ASPIRAZIONE	SOUPAPE D ADMISSION	1
35	PA166F-010002	67D-12121-00	VÁLVULA ESCAPE	VALVE, EXHAUST	VALVOLA SCARICO	SOUPAPE D'ÉCHAPPEMENT	1
36	PAF2.6-04040001	69M-E2155-00	PLETINA EMPUJADORES	PLATE, PUSH ROD	PIASTRA, ASTA DI SPINTA	PLAQUE DE POUSSOIRS	1
37	PAF2.6-04000002	69M-12154-00	VARILLA EMPUJADOR	ROD, VALVE PUSH	ASTICELLA DI SPINTA	TIGE DE CULBUTEUR	2
38	PA166F-000001	JA9-12153-00	EMPUJADOR	LIFTER, VALVE	ASTA	POUSSOIR	2
39	PAF2.6-04000100	69M-12170-01	ÁRBOL DE LEVAS	CAMSHAFT ASSY	ALBERO A CAMME	ARBRE À CAMES	1
40	POWERHEAD2.6	69M-WE0090-01-1S	MOTOR	POWER HEAD	MOTORE	TÊTE MOTRICE	1
41	PAF2.6-00000003	69M-45113-A0	JUNTA BASE MOTOR	GASKET ENGINE	GUARNIZIONE BASE MOTORE	JOINT MOTEUR	1



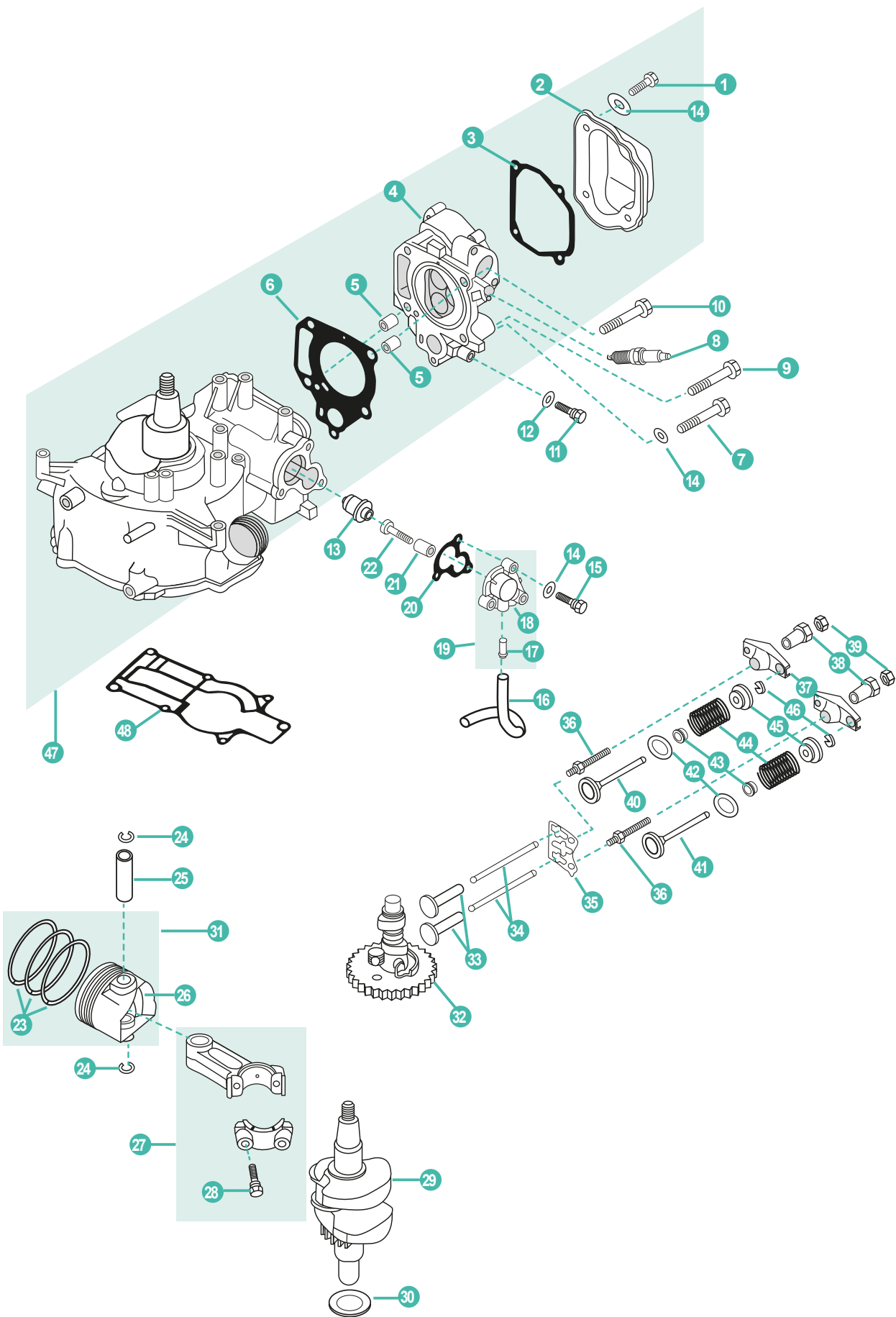

	REF	OEM				UN.	
1	PAGB/T5783-M6X16	90105-06M14	TORNILLO	SCREW	VITE	VIS	4
2	PAF4-04000018	67D-11191-00	TAPA BALANCINES	COVER, CYLINDER HEAD	COPERCHIO PUNTERIE	CACHE CULBUTEUR	1
3	PAF4-04000017	68D-E1193-A0	JUNTA TAPA	GASKET, COVER	GAURNIZIONE COPERCHIO	JOINT COUVERCLE	1
4	PAF4-04080101	68D-E1111-10-1S	CULATA	CYLINDER, HEAD	TESTATA	CULASSE	1
5	PAF4-04000003	99510-10114	PIN	PIN, HOLLOW	SPINOTTO	GOUPILLE FENDUE	2
6	PAF4-04000014	67D-11181-A0	JUNTA CULATA	GASKET, CYLINDER HEAD	GUARNIZIONE TESTATA	JOINT DE CULASSE	1
7	PAGB/T5782-M6X45	90105-06M25	TORNILLO	SCREW	VITE	VIS	1
8	NGKBPR7HS	94702-00248	BUJÍA	SPARK PLUG	CANDELA	BOUGIE	1
9	PAF4-04000034	90105-08M36-00	TORNILLO	SCREW	VITE	VIS	3
10	PAF4-04000033	90105-08046-00	TORNILLO	SCREW	VITE	VIS	1
11	PAGB/T5783-M8X14	97095-08014-00	TORNILLO	SCREW	VITE	VIS	1
12	PAF4-04000006	90430-08800-00	ARANDELA	WASHER, PLATE	RONDELLA	RONDELLE	1
13	REC6AH-12411-00	69M-12411-01	TERMOSTATO	TEHRMOSTAT	TERMOSTATO	THERMOSTAT	1
14	PAGB/T97.1-6	92995-06600	ARANDELA	WASHER, PLATE	RONDELLA	RONDELLE	8
15	PAGB/T5783-M6X20	97095-06020-00	TORNILLO	SCREW	VITE	VIS	3
16	PAF4-04000012	90445-09807	TUBO	PIPE, RETURN	TUBO	DURITE D'EAU	1
17	PAF4-04010102	650-24378-00	PIPA DE AGUA	PIPE, WATER	TUBO	RACCORD TUYAU D'EAU	1
18	PAF4-04070001	67D-12413-00-1S	TAPA TERMOSTATO	COVER, THERMOSTAT	COPERCHIO TERMOSTATO	COUVERCLE THERMOSTAT	1
19	PAF4-04070100	68D-E2413-001S	TAPA TERMOSTATO COMPLETA	COVER ADN SPLIE WATER ASSY	TAPPO TERMOSTATO COMPLETO	COUVERCLE DE THERMOSTAT COMPLET	1
20	PAF4-04000011	68D-E2414-A0	JUNTA TAPA TERMOSTATO	GASKET, THERMOSTAT	GUARNIZIONE COPERCHIO TERMOSTATO	JOINT COUVERCLE DE THERMOSTAT	1
21	PAF4-04070003	68D-E1325-00	ÁNODO	ANODE	ANODO	ANODE	1
22	PAGB/T818-M5X25	97880-05025-00	TORNILLO	SCREW, PANHEAD	VITE	BOULON	1
23	REC68D-E1603-00	68D-E1603-00	KIT SEGMENTOS DE PISTÓN	PISTON RING KIT	KIT FASCIA PISTONE	KIT DE SEGMENTS	1
24	PAF4-04020006	93450-14088	CIRCLIP	CIRCLIP	CIRCLIP	CIRCLIP	2
25	PAF4-04020005	68D-E1633-00	PIN, PISTÓN	PIN, PISTON	SPINOTTO PISTONE	AXE DE PISTON	1
26	PAF4-04020001	68D-E1631-00-96	PISTÓN	PISTON	PISTONE	PISTON	1
27	PAF4-04020100	67D-11650-00	BIELA	ROD, CONNECTING	BIELLA	BIELLE	1
28	PAF4-04020103	67D-11654-00	TORNILLO	SCREW	VITE	VIS	2
29	PAF4-04030000	67D-11400-00	CIGÜEÑAL	CRANK ASSY	ALBERO MOTORE	VILEBREQUIN	1
30	PAF4-04000004	90201-266P2	ARANDELA	WASHER, PLATE	RONDELLA	RONDELLE	1
31	PAF4-04020200	68D-E1631-00-96	PISTÓN	PISTON ASSY	PISTONE	PISTON	1
32	PAF4-04040000	68D-E2170-00	ÁRBOL DE LEVAS	CAMSHAFT ASSY	ALBERO A CAMME	ARBRE À CAMES	1
33	PA166F-000001	JA9-12153-00	EMPUJADOR DE VÁLVULA	LIFTER, VALVE PUSH	ALZA VALVOLA	POUSSOIR	2
34	PAF4-04000015	67D-12154-00	VARILLA EMPUJADOR DE VÁLVULA	ROD, VALVE PUSH	ASTA, ALZA VALVOLA	TIGE DE CULBUTEUR	2
35	PAF4-04080009	68D-E2155-00	PLETINA EMPUJADORES	PLATE, PUSH ROD	PIASTRA, ASTA DI SPINTA	PLAQUE DE POUSSOIRS	1
36	PA166F-010008	67D-12157-00	TORNILLO	SCREW	VITE	VIS	2
37	PA166F-010009	67D-12151-00	BALANCIÓN	VALVE ROCKER	BILANCERE	CULBUTEUR	2
38	PA166F-010010	7FK-12165-00	TUERCA BALANCIÓN	PIVOT, ROCKER ARM	DADO BILANCERE	ECROU DU CULBUTEUR	2
39	PA166F-010011	7FK-12158-00	TUERCA	LOCKNUT	DADO	ECROU	1
40	PAF4-04080005	67D-12111-00	VÁLVULA ADMISIÓN	VALVE, INTAKE	VALVOLA ASPIRAZIONE	SOUPAPE D ADMISSION	1
41	PAF4-04080006	67D-12121-00	VÁLVULA ESCAPE	VALVE, EXHAUST	VALVOLA SCARICO	SOUPAPE D'ECHAPPEMENT	1
42	PAF4-04080007	68T-12116-00	ARANDELA ASIENTO	SEAT, VALVE SPRING	RONDELLA BASAMENTO	SIEGE RESSORT DE SOUPAPE	2
43	PAPS2700.04.03	51Y-12119-00	RETÉN DE VÁLVULA	SEAT, VALVE STEM	GOMMINO VALVOLA	JOINT QUEUE DE SOUPAPE	2
44	PAF4-04080008	68D-E2113-00	MUELLE	SPRING, VALVE INNER	MOLLA	RESSORT DE SOUPAPE	2
45	PAF8-05030006	7NJ-12117-00	RETÉN RESORTE	SPRING, VALVE RETAINER	VALVOLA DI RITEGNO	JOINT DE RESSORT	2
46	PAF8-05030007	7NJ-12118-00	SEGURO DE VÁLVULA	CLAMP, VALVE	BLOCCAGGIO DI VALVOLA	CLAVETTE DE SOUPAPE	2
47	PAF4-04000000	680-WE090-11-15	MOTOR	POWER HEAD 4-5	MOTORE	TÊTE MOTRICE	1
48	PAF4-00000006	67D-45113-A0	JUNTA BASE MOTOR	GASKET ENGINE	GUARNIZIONE BASE MOTORE	JOINT MOTEUR	1

4T F4A/MSHAC/AMH/MLHB-S/MH/MLHE (2002-09)

STROKES

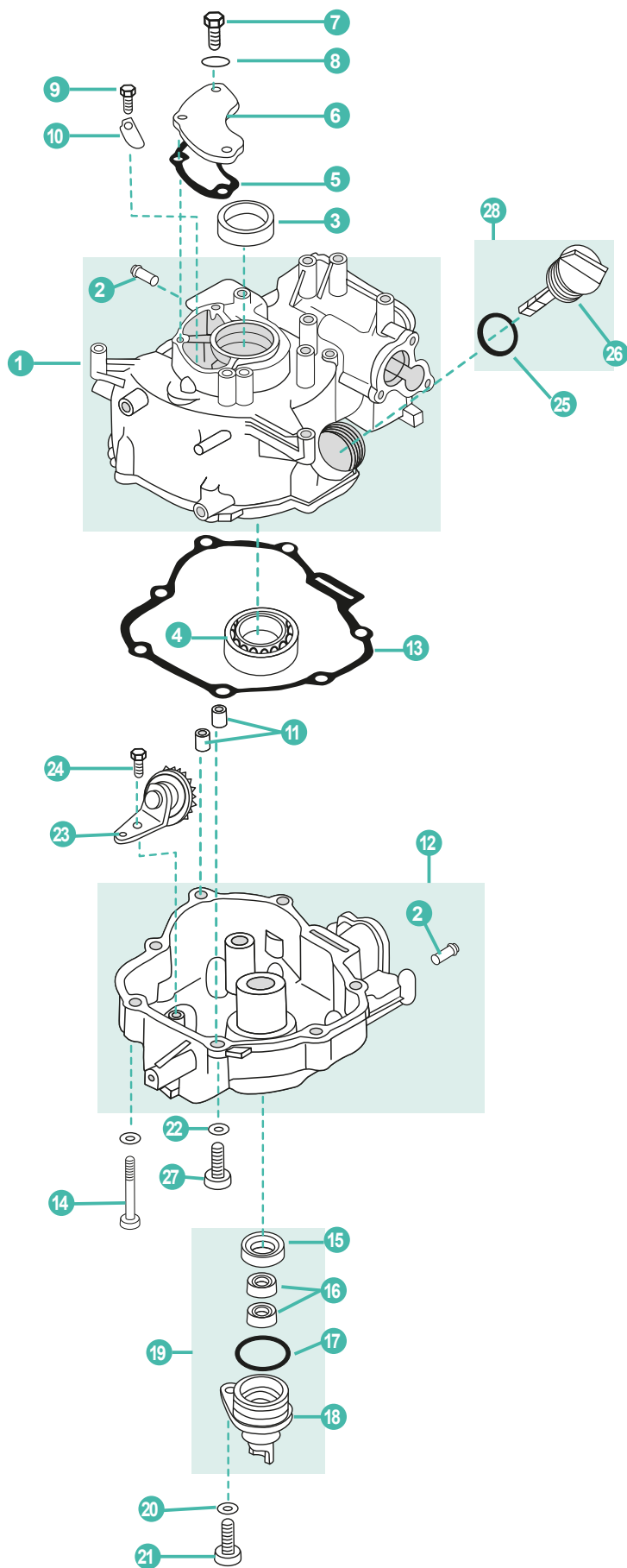

	REF	OEM				UN.	
1	PAF4-04010100	68D-E1311-02-15	CARCASA DE MOTOR	CRANK CASE	COPERCHIO MOTORE	VILEBREQVIN	1
2	PAF4-04010102	650-24378-00	PIPA DE AGUA	PIPE, WATER	TUBO	RACCORD TUYAU D'EAU	2
3	PAF4-04010004	93102-25090	RETÉN	OIL SEAL	PARAOLIO	JOINT	1
4	PAGB/T276-6004C2	93306-205YD	RODAMIENTO	BALL BEARING	CUSCINETTO	ROULEMENT À BILLE	1
5	PAF4-04000009	68D-E1169-A0	JUNTA	BREATHER GASKET	GUARNIZIONE	JOINT	1
6	PAF4-04000010	68D-E1168-00	TAPA	COVER	COPERCHIO	COUVERCLE	1
7	PAGB/T5783-M6X14	90119-06M80-00	TORNILLO	SCREW	VITE	VIS	3
8	PAGB/T97.1-6	92885-06600	ARANDELA	WASHER	RONDELLA	RONDELLE	3
9	PAGB/T818-M4X6	98503-04066-00	TORNILLO	SCREW	VITE	VIS	1
10	PAF4-04010003	68D-E5346-00	VÁLVULA	VALVE	VALVOLA	SOUPAPE	1
11	PAF4-04000003	99510-10114	PIN	HOLLOWPIN	SPINOTTO	GOUPILLE FENDUE	2
12	PAF4-04050200	68D-E5111-00-1S	CARTER	COVER, CRANK CASE	CARTER	CARTER	1
13	PAF4-04000002	68D-11351-A0	JUNTA CARTER	CRANK CASE COMPLEX	GUARNIZIONE CARTER	JOINT DE CARTER	1
14	PAGB/T5787-1986	97575-08550-00	TORNILLO	SCREW	VITE	VIS	7
15	PAF2.6-04010001	93102-20108	RETÉN	OIL SEAL	PARAOLIO	JOINT	1
16	PAF4-04060004	93102-10004	RETÉN	OIL SEAL	PARAOLIO	JOINT	2
17	PAF4-04060002	93210-35537	TÓRICA	O-RING	O-RING	JOINT TORIQUE	1
18	PAF4-04060001	68D-E5396-00-5B	CUERPO DEL RETÉN	SHELL, OIL SEAL	GUARNIZIONE CORPO	LOGEMENT JOINT D'HUILE	1
19	PAF4-04060000	6EE-E5396-00-CA	CUERPO RETÉN COMPLETO	OIL SEAL, SHELL ASSY	CORPO GUARNIZIONE COMPLETO	LOGEMENT JOINT D'HUILE, COMPLET	1
20	PAGB/T97.1-8	92955-08600-00	ARANDELA	WASHER, PLATE	RONDELLA	RONDELLE	8
21	PAGB/T5783-M8X20	97095-08020-00	TORNILLO	BOLT, HEXAGON	VITE	BOULON	1
22	PAF4-04000006	90201-08818	ARANDELA	WASHER	RONDELLA	RONDELLE	1
23	PAF4-04050100	68D-E3102-00	PIÑÓN COMPELTO	GEAR UNIT ASSY	PIGNONE	PIGNON	1
24	PAGB/T5783-M6X12	95817-06012-00	TORNILLO	SCREW	VITE	VIS	1
25	PAF4-04000008	93210-24M79	TÓRICA	O-RING	O-RING	JOINT TORIQUE	1
26	PAF4-04000007	68D-E5362-00	TAPÓN MEDIDOR NIVEL	PLUG WITH DIPSTICK	TAPPO LIVELLO	BOUCHON AVEC JAUGE D'HUILE	1
27	PAF4-04000001	97095-08020-00	TORNILLO DRENAJE	BOLT, DISCHARGING OIL	VITE DRENAGGIO	VIS DE VIDANGE	1
28	PAF4-04000036	6EE-E5362-00	TAPÓN COMPLETO	PLUG ASSY	TAPPO COMPLETO	BOUCHON COMPLET	1





4T F4B-M • F5A • F6C-M  
STROKES



YAMAHA

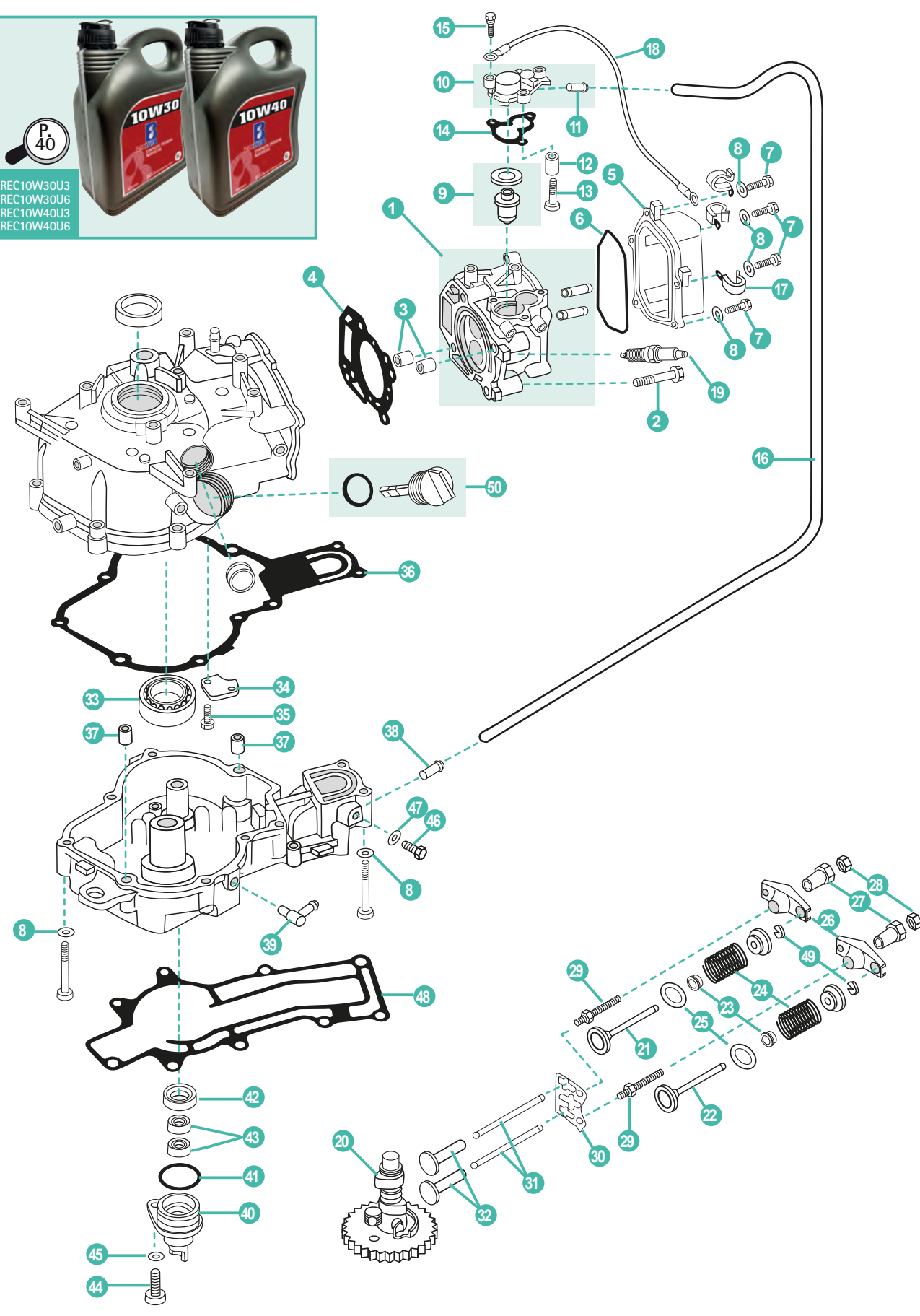

RECAMBIOS  
MARINOS

	REF	OEM					UN.
1	PAF6-04050100	6BX-E1111-00-1S	CULATA COMPLETA	CYLINDER HEAD ASSY	TESTATA COMPLETA	CULASSE COMPLETE	1
2	PAF4-04000034	90105-08M36	TORNILLO	SCREW	VITE	VIS	4
3	PAF4-04000003	99510-10114	PIN CENTRADOR	HOLLOW PIN	SPINOTTO DI CENTRAGGIO	PIN DE CENTRAGE	2
4	PAF6-04000002	6BX-11181-00	JUNTA CULATA	GASKET, CYLINDER HEAD	GUARNIZIONE TESTATA	JOINT DE CULASSE	1
5	PAF6-04000004	6BX-E1191-00-5B	TAPA CULATA DE CILINDRO	COVER CYLINDER HEAD	COPERCHIO TESTA CILINDRO	CACHE CULBUTEUR	1
6	PAF6-04000005	6BX-11356-00	RETÉN DE ACEITE	SEAL RING	PARAOLIO	JOINT CACHE CULBUTEUR	1
7	PAGB/T5783-M6X20	97095-06020	TORNILLO	SCREW	VITE	VIS	5
8	PAGB/T97.1-6	92995-06600	ARANDELA	WASHER	RONDELLA	RONDELLE	15
9	PAF15-07000031	66M-12411-01	TERMOSTATO	THERMOSTAT	TERMOSTATO	THERMOSTAT	1
10	PAF4-04070000	68D-E2413-00-1S	TAPA TERMOSTATO	COVER, THERMOSTAT	COPERCHIO TERMOSTATO	COUVERCLE THERMOSTAT	1
11	PAF4-04010102	650-24378-00	NIPLE	NIPPLE	RACCORDO	RACCORD	1
12	PAF4-04070003	68D-E1325-00	ÁNODO	ANODE	ANODO	ANODE	1
13	PAGB/T818-M5X25	97880-05025	TORNILLO	SCREW	VITE	VIS	1
14	PAF4-04000011	68D-E2414-A0	JUNTA TAPA TERMOSTATO	GASKET, THERMOSTAT COVER	GUARNIZIONE COPERCHIO TERMOSTATO	JOINT COUVERCLE DE THERMOSTAT	1
15	PAGB/T5783-M6X20	90119-06MA2	TORNILLO	SCREW	VITE	VIS	3
16	PAF6-04000020	6BX-F4323-00	TUBO	TUBE	TUBO	DURITE D'EAU	1
17	PAT36-04000023	90465-06M86	BRIDA	CLAMP	FLANGIA	COLLIER	1
18	PAF6-04000009	6G0-82519-00	CABLE MASA	WIRE LEAD	PORTA CAVO	CABLE	1
19	NGKCR6HSB	94702-00372	BUJÍA	SPARK PLUG	CANDELA	BOUGIE	1
20	PAF6-04030000	6BX-E2170-00	ÁRBOL DE LEVAS	CAMSHAFT ASSY	ALBERO A CAMME	ARBRE À CAMES	1
21	PAF6-04050001	6BX-12111-00	VÁLVULA ADMISIÓN	VALVE, INTAKE	VALVOLA ASPIRAZIONE	SOUPEPE D ADMISSION	1
22	PAF6-04050002	6AU-12121-00	VÁLVULA ESCAPE	VALVE, EXHAUST	VALVOLA SCARICO	SOUPEPE D'ÉCHAPPEMENT	1
23	PAF166-010003	51Y-12119-00	RETÉN DE ACEITE	SEAL RING	PARAOLIO	JOINT D'HUILE	2
24	PAF6-04050003	60R-12113-00	RESORTE DE VÁLVULA	SPRING, VALVE	MOLLA VALVOLA	RESSORT	2
25	PAF4-04080007	68T-12116-00	RETÉN RESORTE	SPRING, VALVE RETAINER	VALVOLA DI RITEGNO	JOINT DE RESSORT	2
26	PA166F-010009	67D-12151-00	BRAZO DE BALANCÍN	ARM, VALVE ROCKER	BILANCERE	CULBUTEUR	2
27	PA166F-010010	7FK-12165-00	TUERCA BALANCÍN	PIVOT, ROCKER ARM	DADO BILANCERE	PIVOT CULBUTEUR	2
28	PA166F-010011	7FK-12158-00	TUERCA	LOCK NUT	DADO	ÉCROU	2
29	PA166F-010008	67D-12157-00	PERNO	BOLT	PERNO	BOULON	2
30	PAF6-04050004	6BX-E2155-00	PLETINA EMPUJADORES	PLATE, PUSH ROD	PIASTRA, ASTA DI SPINTA	PLAQUE DE POUSSOIRS	1
31	PAF6-04000003	6BX-12154-00	VARILLA EMPUJADOR	ROD, VALVE PUSH	ASTICELLA DI SPINTA	TIGE DE CULBUTEUR	2
32	PA166F-000001	JA9-12153-00	EMPUJADOR DE VÁLVULA	LIFTER, VALVE PUSH	ALZA VALVOLA	POUSSOIR	2
33	PANTN6205C3	93306-205B2	RODAMIENTO	BALL BEARING	CUSCINETTO	ROULEMENT À BILLE	1
34	PAF6-04010004	6BX-E1168-00	CUBIERTA DE RESPIRADERO	OIL BAFFLE PLATE	DIAFRAMMA OLIO	JOINT DE CARTER D'HUILE	1
35	PAGB/T5783-M5X10	97013-05010	PERNO	BOLT	PERNO	BOULON	2
36	PAF6-04000001	6BX-11351-00	JUNTA BASE MOTOR	GASKET ENGINE	GUARNIZIONE BASE MOTORE	JOINT MOTEUR	1
37	PAF4-04000003	99510-10114	PIN CENTRADOR	HOLLOW PIN	SPINOTTO DI CENTRAGGIO	PIN DE CENTRAGE	2
38	PAF4-04010102	650-24378-00	PIPA DE AGUA	PIPE, WATER	TUBO	RACCORD TUYAU D'EAU	1
39	PAF15-04000005	676-11372-00	NIPLE DE MANGUERA	WATER NIPPLE	RACCORDO COMPLETO	RACCORD D'EAU	1
40	PAF4-04060001	68D-E5396-00-5B	CAJA DE SELLO DE ACEITE	SHELL, OIL SEAL	GUARNIZIONE CORPO OLIO	LOGEMENT JOINT D'HUILE	1
41	PAGB/T345.2-D32.5XD1	93210-35537	TÓRICA	O-RING	O-RING	JOINT TORIQUE	1
42	PAF2.6-04010001	93102-20108	RETÉN DE ACEITE	SEAL RING	PARAOLIO	JOINT SPI	1
43	PAF4-04060004	93102-10004	RETÉN DE ACEITE	SEAL RING	PARAOLIO	JOINT SPI	2
44	PAGB/T5783-M8X20	97095-08020	PERNO	BOLT	PERNO	BOULON	1
45	PAGB/T97.1-8	92995-08600	ARANDELA	WASHER	RONDELLA	RONDELLE	1
46	PAGB/T5783-M8X14	97095-08014	PERNO	BOLT	PERNO	BOULON	1
47	PAF4-04000006	90430-08800	JUNTA	GASKET	GUARNIZIONE	JOINT	1
48	PAF6-00000001	6BX-45113-00	JUNTA	GASKET	GUARNIZIONE	JOINT	1
49	PAF8-05030007	7NJ-12118-00	CLIP	CLIP	CLIP	CLIP	1
50	PAF4-04000010	68D-E5362-00	TAPÓN COMPLETO	PLUG ASSY	TAPPO COMPLETO	BOUCHON COMPLET	1

4T F6A/M/B • FT/T/F8C/M/D/P/E/F • F9.9F • FT9.9G • F9.9J • FT9.9L  
STROKES

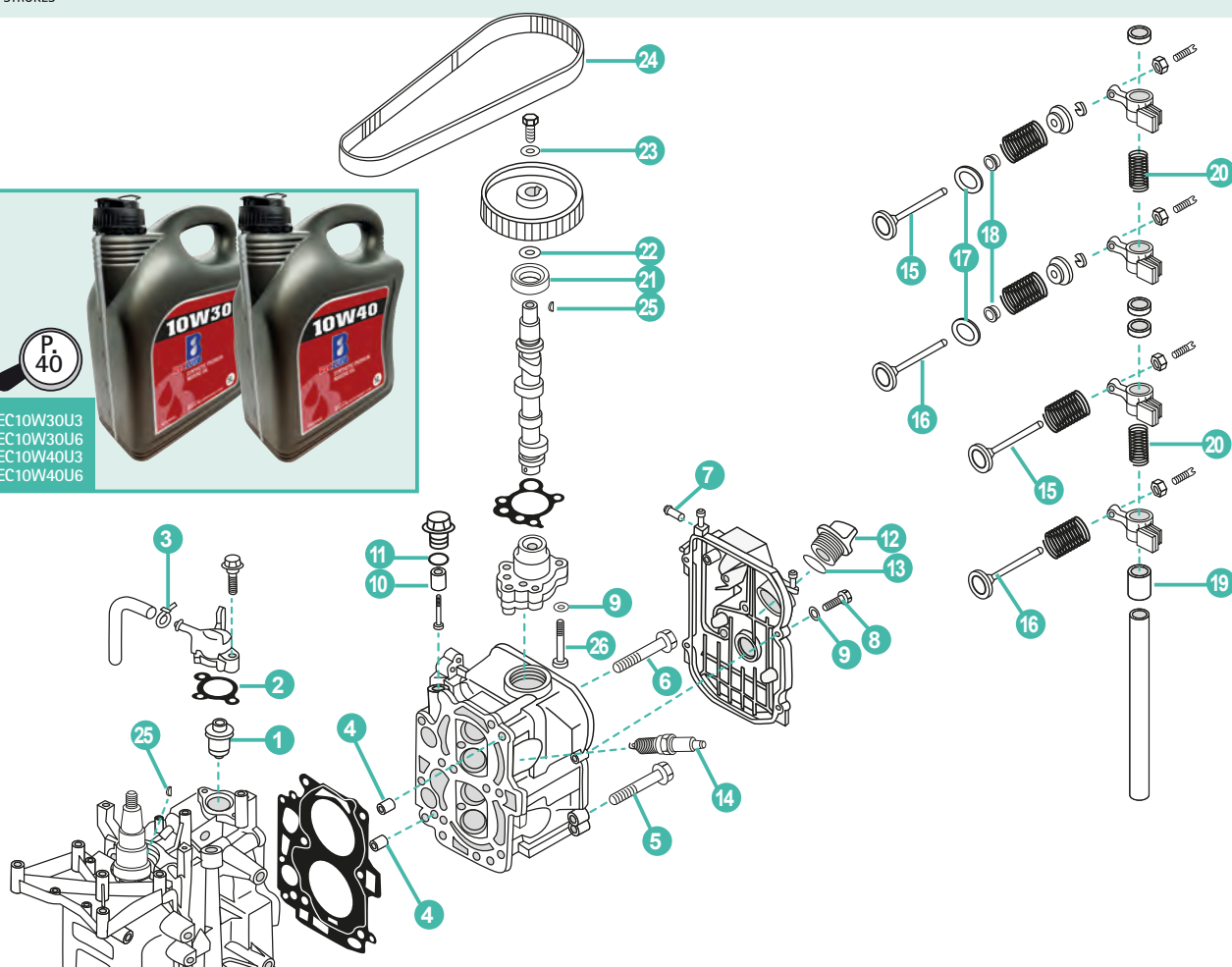

	REF	OEM					UN.
1	PAF15-07000031	66M-12411-01	TERMOSTATO	THERMOSTAT	TERMOSTATO	THERMOSTAT	1
2	REC6G8-12414-A0	60R-E2414-A0	JUNTA	GASKET	GUANIZIONE	JOINT	1
3	PAHT-2.5X60	90465-11M10	BRIDA	CLAMP	FLANGIA	COLLIER	1
4	PAF15-07000001	99510-10114	PIN CENTRADOR	HOLLOW PIN	SPINOTTO DI CENTRAGGIO	PIN DE CENTRAGE	2
5	PAF4-04000034	90105-08M36	TORNILLO	SCREW	VITE	VIS	2
6	PAF15-07000028	90105-08M78	TORNILLO	SCREW	VITE	VIS	4
7	PAF4-04010102	650-24378-00	PIPA DE AGUA	PIPE, WATER	TUBO	RACCORD TUYAU D'EAU	1
8	PAGB/T5783-M6X20	97095-06020	TORNILLO	BOLT	VITE	BOULON	4
9	PAGB/T97.1-6	92995-06600	ARANDELA	WASHER	RONDELLA	RONDELLE	7
10	CM6G8-11325-00A	6G8-11325-00	ÁNODO	ANODE	ANODO	ANODE	1
11	PAGB/T3452.1-13X2	93210-13M63	TÓRICA	O-RING	O-RING	JOINT TORIQUE	1
12	PAF15-07050004	69M-E5363-00	TAPÓN ACEITE	PLUG, OIL	TAPPO OLIO	BOUCHON REMPLISSAGE D'HUILE	1
13	PAF4-04000008	93210-24M79	TÓRICA	O-RING	O-RING	JOINT TORIQUE	1
14	NGKBR6HS-10	94702-00274	BUJÍA	SPARK PLUG	CANDELA	BOUGIE	2
15	PA166F-010001	67D-12111-00	VÁLVULA ADMISIÓN	VALVE, INTAKE	VALVOLA ASPIRAZIONE	SOUPAPE D ADMISSION	2
16	PAF4-04080006	67D-12121-00	VÁLVULA ESCAPE	VALVE, EXHAUST	VALVOLA SCARICO	SOUPAPE D'ECHAPPEMENT	2
17	PAF4-04080007	68T-12116-00	ARANDELA DE ASIENTO	SEAT, VALVE SPRING	RONDELLA BASAMENTO	SIEGE RESSORT DE SOUPAPE	2
18	PA166F-010003	51Y-12119-00	RETÉN DE ACEITE	SEAL RING	PARAOILIO	JOINT D'HUILE	4
19	PAF15-07040012	90387-13M56	CASQUILLO	BUSHER	BOCCOLA	BAGUE	1
20	PAF15-07040014	90501-12M40	RESORTE DE COMPRESIÓN	SPRING, ROCKER	MOLLA	RESSORT ROCKER	2
21	PAF15-07040008	93102-18M21	RETÉN DE ACEITE	SEAL RING	PARAOILIO	JOINT D'HUILE	1
22	PAF15-07040017	90201-13201	ARANDELA	WASHER	RONDELLA	RONDELLE	1
23	PAGB/T5287-6	90201-06M94	ARANDELA	WASHER	RONDELLA	RONDELLE	1
24	REC68T-46241-00	60R-G6241-00	CORREA	BELT	CINGHIA	COURROIE DISTRIBUTION	1
25	PAGB/T1099-3X5X13	90280-03M01	CHAVETA	KEY WOODRUFF	CHIAVETTA	CLAVETTE	2
26	PAGB/T5783-M6X30	97095-06030	PERNO	BOLT	VITE	BOULON	3

4T  
STROKES

F8AM/BM/B/BE • F9.9 AE/AM/B/BE/BMH/ELH (1985-99)

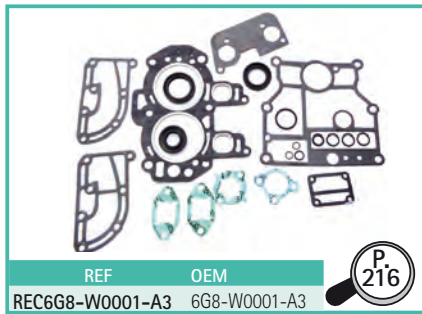
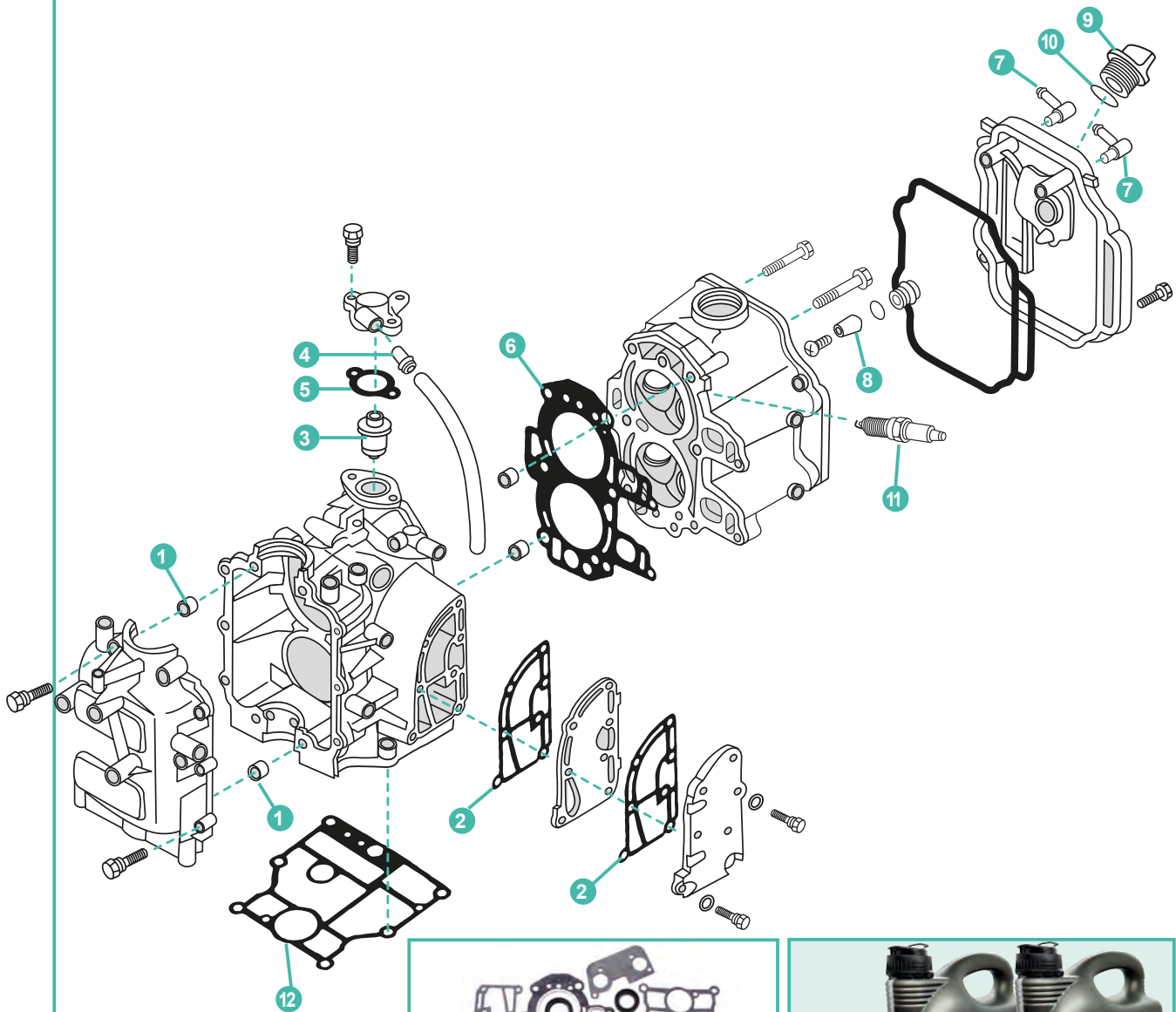

	REF	OEM					UN.
1	PAF15-07000001	91810-03014	PIN	PIN	PIN	PIN	2
2	REC6G8-41112-02	6G8-41112-02	JUNTA	GASKET	GUARNIZIONE	JOINT	2
3	REC6AH-12411-00	6G8-12411-00	TERMOSTATO	THERMOSTAT	TERMOSTATO	THERMOSTAT	1
4	PAF15-07010006	6E5-24377-00	PIPA DE AGUA	PIPE, WATER	TUBO	RACCORD TUYAU D'EAU	1
5	REC6G8-12414-A0	6G8-12414-00	JUNTA TAPA TERMOSTATO	GASKET, THERMOSTAT COVER	GUARNIZIONE COPERCHIO TERMOSTATO	JOINT COUVERCLE DE THERMOSTAT	1
6	REC6G8-11181-A1	6G8-11181-00	JUNTA CULATA	GASKET, CYLINDER HEAD	GUARNIZIONE TESTATA	JOINT DE CULASSE	1
7	PAF15-04000005	676-11372-00	NIPLA	HOSE NIPLA	TUBO	TUYAU	2
8	CM6G8-11325-00	6G8-11325-00	ÁNODO	ANODE	ANODO	ANODE	1
9	PAF15-07050004	6G8-15363-00	TAPÓN ACEITE	PLUG, OIL	TAPPO OLIO	BOUCHON REMPLISSAGE D'HUILE	1
10	PAJASOF40431-025	93210-24M79	TÓRICA	O-RING	O-RING	JOINT TORIQUE	1
11	NGKCR6HS	94701-00282	BUJÍA	SPARK PLUG	CANDELA	BOUGIE	2
12	REC6G8-11351-A0	6G8-11351-00	JUNTA BASE MOTOR	GASKET ENGINE	GUARNIZIONE BASE MOTOR	JOINT MOTEUR	1

YAMAHA

RECAMBIOS  
MARINOS



4T F9.9 (2004-06) • F9.9C • F13.5 (2003-06) • F15 (2003-07) • F15A  
STROKES

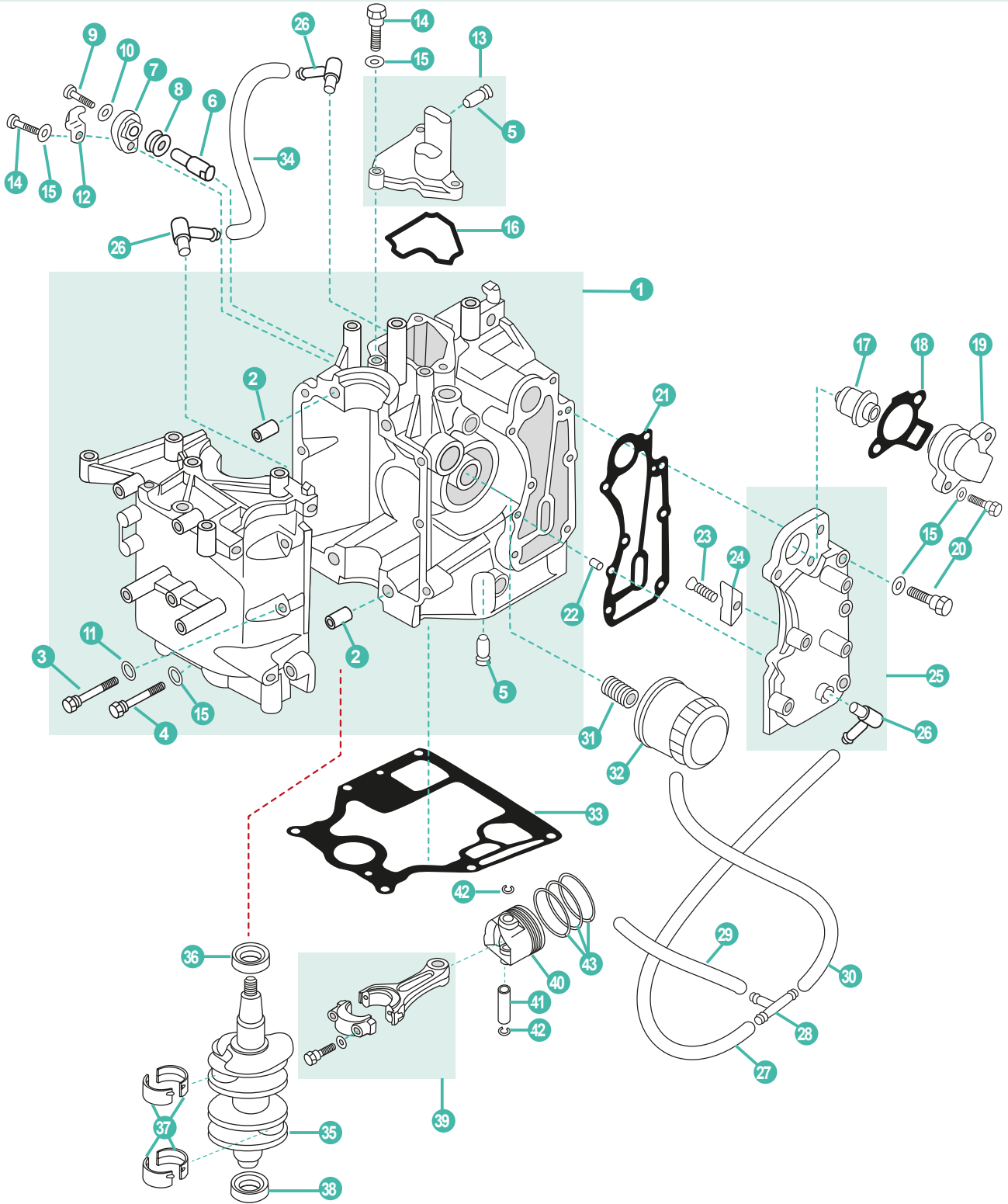

REF	OEM
REC66M-W0093-01	66M-W0093-01

P 95

REF	OEM
REC66M-W0001-01	66M-W0001-01

P 216

P 40

REC10W30U3  
REC10W30U6  
REC10W40U3  
REC10W40U6

	REF	OEM				UN.	
1	PAF15-07010000	66M-15100-02-15	BLOQUE MOTOR COMPLETO	CRANKCASE ASSY	BLOCCO MOTORE COMPLETO	CARTER BLOC MOTEUR	1
2	PAF15-07000001	99510-10114	PIN CENTRADOR	HOLLOW PIN	SPINOTTO DI CENTRAGGIO	PIN DE CENTRAGE	2
3	PAGB/T5783-M5X12	93102-25090	TORNILLO	SCREW	VITE	VIS	6
4	PAGB/T5783-M5X12	93306-205YD	TORNILLO	SCREW	VITE	VIS	4
5	PAF15-07010006	6E5-24377-00	PIPA DE AGUA	PIPE, WATER	TUBO	RACCORD TUYAU D'EAU	2
6	PAF15-07010008	66M-11325-00	ÁNODO	ANODE	ANODO	ANODE	1
7	PAF15-07010011	66M-11327-00-94	TAPA ÁNODO	COVER, ANODE	COPERTURA ANODO	COUVERCLE DU ANODE	1
8	PAF15-07010009	66M-11328-00	ALOJAMIENTO ÁNODO	GROMMET, ANODE	ALLOGGIAMENTO ANODO	JOINT D'ANODE	1
9	PAGB/T5783-M5X12	97095-0512	TORNILLO	SCREW	VITE	VIS	1
10	PAGB/T97.1-8	92995-05600	ARANDELA	WASHER	RONDELLA	RONDELLE	1
11	PAGB/T97.1-8	97595-06520	ARANDELA	WASHER	RONDELLA	RONDELLE	4
12	PAF15-07010012	66M-12535-00	EMPAQUETADORA DE ÁNODO	PLATE, ANODE	PIASTRA ANODO	PLAQUE D'ANODE	1
13	PAF15-07010200	66M-11168-001S	TAPA	COVER, BREATHER	COPERCHIO	COUVERCLE	1
14	PAGB/T5783-M5X12	97575-08550-00	TORNILLO	SCREW	VITE	VIS	4
15	PAGB/T97.1-8	93102-20108	ARANDELA	WASHER	RONDELLA	RONDELLE	17
16	PAF15-07010014	66M-11357-00	JUNTA TAPA	GASKET, COVER	GAURNIZIONE COPERCHIO	JOINT COUVERCLE	1
17	PAF15-07000031	66M-12411-01	TERMOSTATO	THERMOSTAT	TERMOSTATO	THERMOSTAT	1
18	PAF15-07010022	62Y-12414-00	JUNTA TAPA TERMOSTATO	GASKET, THERMOSTAT COVER	GUARNIZIONE COPERCHIO TERMOSTATO	JOINT COUVERCLE DE THERMOSTAT	1
19	PAF15-07010021	6H3-12413-001S	TAPA TERMOSTATO	COVER, THERMOSTAT	COPERCHIO TERMOSTATO	COUVERCLE DE THERMOSTAT	1
20	PAGB/T5783-M5X12	90201-08818	TORNILLO	SCREW	VITE	VIS	7
21	PAF15-07010018	66M-41114-01	JUNTA EXTERIR, TAPA DE ESCAPE	GASKET, EXHAUST OUTER COVER	GUARNIZIONE ESTERIORE, COPERCHIO SCARICO	JOINT DE COUVERCLE EXT ECHAPPEMENT	1
22	PAF15-07000013	93604-12M07	PIN	OPIN	SPINOTTO	LEVIER D'ENTRAINEMENT	2
23	PAGB/T5783-M5X12	68D-E5362-00	TORNILLO	SCREW	VITE	VIS	1
24	PAF15-07010026	6E5-11325-00	ÁNODO	ANODE	ANODO	ANODE	1
25	PAF15-07010019	66M-41113-20-1S	TAPA ESCAPE COMPLETA	OUTTER COVER, EXHAUST	COPERCHIO SCARICO COMPLETA	COUVERCLE ECHAPPEMENT EXTERIEUR	1
26	PAF15-04000005	676-11372-00	NIPLE DE MANGUERA	NIPPLE	TUBO	RACCORD D'EAU	3
27	PAF15-05000012	90445-09061	TUBO	HOSE A	TUBO	DURITE D'EAU	1
28	PAF15-05000011	688-24378-00	CONECTOR DE 3 VÍAS	THREE-WAY PIPE	CONNETTORE T	TE	1
29	PAF15-05000013	90445-09086	TUBO	HOSE B	TUBO	DURITE D'EAU	1
30	PAF15-05000014	90445-09104	TUBO	HOSE C	TUBO	DURITE D'EAU	1
31	PAF15-07010003	90401-20M00	TORNILLO	SCREW	VITE	VIS	1
32	PAF15-07010023	5GH-13440-00	FILTRO ACEITE	OIL FILTER	FILTRO DELL'OLIO	FILTRE À HUILE	1
	REC5GH-13440-00	5GH-13440-00	FILTRO ACEITE	OIL FILTER	FILTRO DELL'OLIO	FILTRE À HUILE	1
33	PAF15-00000014	66M-11351-10	JUNTA BASE MOTOR	GASKET ENGINE	GUARNIZIONE BASE MOTORE	JOINT MOTEUR	1
34	PAF15-07010007	90445-10M46	TUBO	HOSE, RETURN OIL	TUBO	TUYAU	1
35	PAF15-07030000	66M-11411-00	CIGÜEÑAL	CRANK ASSY	ALBERO MOTORE	VILEBREQUIN	1
36	PAF15-07030006	93102-35M51	RETÉN DE ACEITE	OIL SEAL	PARAOLIO	JOINT D'HUILE	1
37	PAF15-07010024	66M-11416-00	COJINETE BANCADA	MAIN BEARING	CUSCINETTO	PALIER DE VILEBREQUIN	4
38	PAF15-07030007	93102-25M52	RETÉN DE ACEITE	OIL SEAL	PARAOLIO	JOINT D'HUILE	1
39	PAF15-07020100	66M-11650-00	BIELA	ROD, CONNECTING	BIELLA	BIELLE	2
40	PAF15-07020001	66M-11631-00-96	PISTÓN	PISTON	PISTONE	PISTON	2
41	PAF15-07020006	634-11633-00	BULÓN	PIN, PISTON	BULLONE	AXE DE PISTON	2
42	PAF15-07020005	93450-15023	CIRCLIP	CIRCLIP	CIRCLIP	CIRCLIP	4
43	REC66N-11603-00	66N-11603-00	KIT SEGMENTOS DE PISTÓN	PISTON RING KIT	KIT FASCIA PISTONE	KIT DE SEGMENTS	2

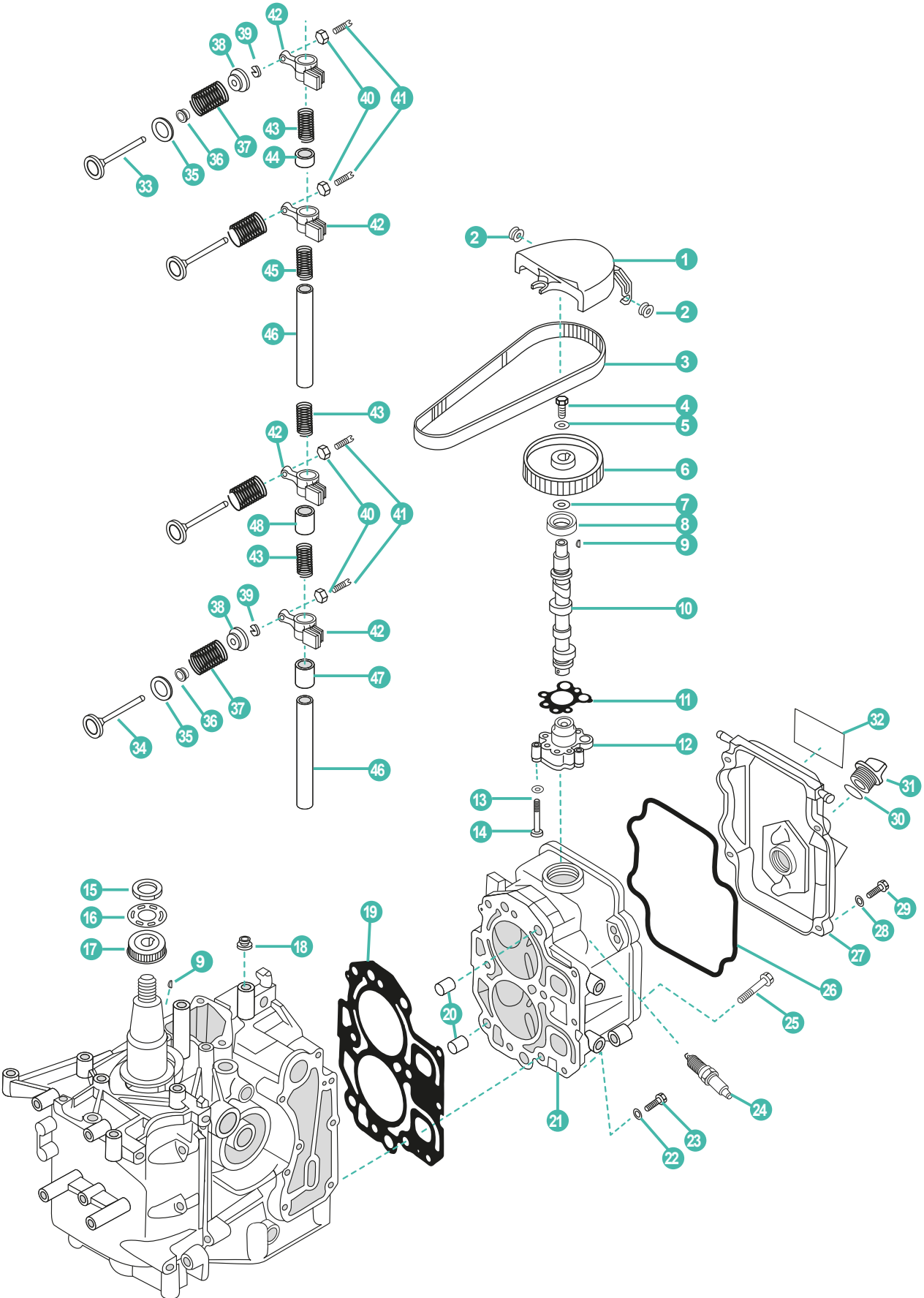

	REF	OEM					UN.
1	PAF15-07000024	66M-46297-00	TAPA	COVER, DUST	COPERCHIO	COUVERCLE	1
2	PAF15-07050003	90480-10M16	GOMA	RING RUBBER A	GOMMINO	BAGUE DE COUVERCLE	2
3	REC66M-46241-00	66M-46241-00	CORREA DISTRIBUCIÓN	BELT TIMING	CINGHIA DISTRIBUZIONE	COURROIE DISTRIBUTION	1
4	PAGB/T5783-M5X12	97013-06016	TORNILLO	BOLT	VITE	VIS	1
5	PAGB/T5287-6	90201-06M94	ARANDELA	BIG WASHER	RONDELLA	RONDELLE	1
6	PAF15-07040018	66M-11537-00-94	POLEA DE CORREA	BELT PULLEY, DRIVEN	PULEGGIA	POULIE DE COURROIE	1
7	PAF15-07040017	90201-13201	ARANDELA	WASHER	RONDELLA	RONDELLE	1
8	PAF15-07040008	93102-18M21	RETÉN DE ACEITE	OIL SEAL	PARAOLIO	JOINT D'HUILE	1
9	PAGB/T1099-3X5X13	90280-03M01	CHAVETA	KEY, WOODRUFF	CHIAVETTA	CLAVETTE	2
10	PAF15-07040200	66M-12170-00	ÁRBOL DE LEVAS	CAMSHAFT ASSY	ALBERO A CAMME	ARBRE À CAMES	1
11	PAF15-07040016	66M-13329-10	JUNTA	MAT, AIRPROOF	GUARNIZIONE	JOINT	1
12	PAF15-07040500	66M-13300-10	BOMBA ACEITE	OIL PUMP ASSY	POMPA DELL'OLIO	POMPE À HUILE	1
13	PAGB/T97.1-8	92995-06600	ARANDELA	WASHER	RONDELLA	RONDELLE	3
14	PAGB/T5783-M5X12	97095-06035	TORNILLO	BOLT	VITE	VIS	3
15	PAF15-07030005	90170-28M37	TUERCA	NUT	GHIERA	ÉCROU	1
16	PAF15-07030004	66M-11557-00	ARANDELA	WASHER	RONDELLA	RONDELLE	1
17	PAF15-07030003	66M-11536-10	POLEA DENTADA	BELT PULLEY, TIMING	PULEGGIA	POULIE	1
18	PAF15-07010027	90480-12072	GOMA	RUBBER RING	GOMMINO	BAGUE DE COUVERCLE	1
19	PAF15-07000100	66M-11181-10	JUNTA CULATA	GASKET, CYLINDER HEAD	GUARNIZIONE TESTATA	JOINT DE CULASSE	1
20	PAF15-07000001	99510-10114	PIN CENTRADOR	HOLLOW PIN	SPINOTTO DI CENTRAGGIO	PIN DE CENTRAGE	2
21	PAF15-07040000	66M-11111-01-1S	CULATA	CYLINDER HEAD ASSY	TESTATA	CULASSE	1
22	PAGB/T97.1-6	92990-06600	ARANDELA	WASHER	RONDELLA	RONDELLE	3
23	PAGB/T5783-M6X25	97513-06525	TORNILLO	BOLT	VITE	VIS	3
24	NGKDP7EA-9	94701-00375	BUJÍA	SPARK PLUG	CANDELA	BOUGIE	2
25	PAF15-07000028	90105-08M78	TORNILLO	BOLT, FLANGE	VITE	VIS	6
26	PAF15-07050002	66M-11356-00	JUNTA TAPA	SEAL, CYLINDER COVER	GAURNIZIONE COPERCHIO	JOINT COUVERCLE	1
27	PAF15-07050001	66M-11191-00-1S	TAPA BALANCINES	COVER, CYLINDER HEAD	COPERCHIO PUNTERIE	CACHE CULBUTEUR	1
28	PAGB/T5783-M5X12	92995-06600	ARANDELA	WASHER, PLATE	RONDELLA	RONDELLE	7
29	PAGB/T5783-M6X20	97595-06520	TORNILLO	BOLT	VITE	VIS	4
30	PAF4-04000008	93210-24M79	TÓRICA	O-RING	O-RING	TORIQUE	1
31	PAF15-07050004	6G8-15363-00	TAPÓN ACEITE	PLUG, OIL	TAPPO OLIO	BOUCHON REMPLISSAGE D'HUILE	1
32	PAF15-10030001	66M-12138-60	ADHESIVO 4	MARK 4	ADESIVO 4	AUTOCOLLANT 4	1
33	PAF15-07040001	66M-12111-00	VÁLVULA ADMISIÓN	VALVE, INTAKE	VALVOLA ASPIRAZIONE	SOUPAPE D ADMISSION	2
34	PAF15-07040002	66M-12121-00	VÁLVULA ESCAPE	VALVE, EXHAUST	VALVOLA SCARICO	SOUPAPE D'ÉCHAPPEMENT	2
35	PAF15-07040004	66M-12116-00	ARANDELA DE ASIENTO	SEAT, VALVE SPRING	RONDELLA BASAMENTO	SIEGE RESSORT DE SOUPAPE	4
36	PAPS2700.04.03	51Y-12119-00	RETÉN	SEAL, VALVESTEM	GUARNIZIONE	JOINT D'HUILE	4
37	PAF15-07040005	66M-12113-00	MUELLE	SPRING, VALVE	MOLLA	RESSORT	4
38	PAF15-07050006	30X-12117-00	RETÉN RESORTE	SPRING, VALVE RETAINER	VALVOLA DI RITEGNO	JOINT DE RESSORT	4
39	PAF15-07040007	30X-12118-00	SEGURO DE VÁLVULA	CLAMP, VALVE	BLOCCAGGIO DI VALVOLA	CLAVETTE DE SOUPAPE	8
40	PAF15-07040304	62Y-12158-00	TUERCA	LOCK NUT	DADO	ÉCROU	4
41	PAF15-07040303	62Y-12159-00	TORNILLO REGULADOR	SCREW, VALVE ADJUSTING	VITE REGOLATORE	VIS POINTEAU	4
42	PAF15-07040301	66M-12151-10	BALANCÍN	VALVE ROCKER	BILANCERE	CULBUTEUR	4
43	PAF15-07040014	90501-12M40	MUELLE	SPRING, ROCKER	MOLLA	RESSORT	3
44	PAF15-07040009	90387-13001	CASQUILLO	BUSHER	GOMMINO	DOUILLE	1
45	PAF15-07040013	90501-12M41	MUELLE	SPRING, ROCKER A	MOLLA	RESSORT	1
46	PAF15-07040015	66M-12146-00	EJE DE BALANCÍN	SHAFT, ROCKER	ASSE BILANCERE	AXE DE CULBUTEUR	2
47	PAF15-07040012	90387-13M56	CASQUILLO B	BUSHER B	GOMMINO B	BAGUE B	1
48	PAF15-07040011	90387-13002	CASQUILLO A	BUSHER A	GOMMINO A	BAGUE A	1
49	PAF15-07000000	66M-W009B-15-1S	MOTOR COMPLETO	POWER HEAD COMPLETE	MOTORE COMPLETO	MOTEUR COMPLET	1



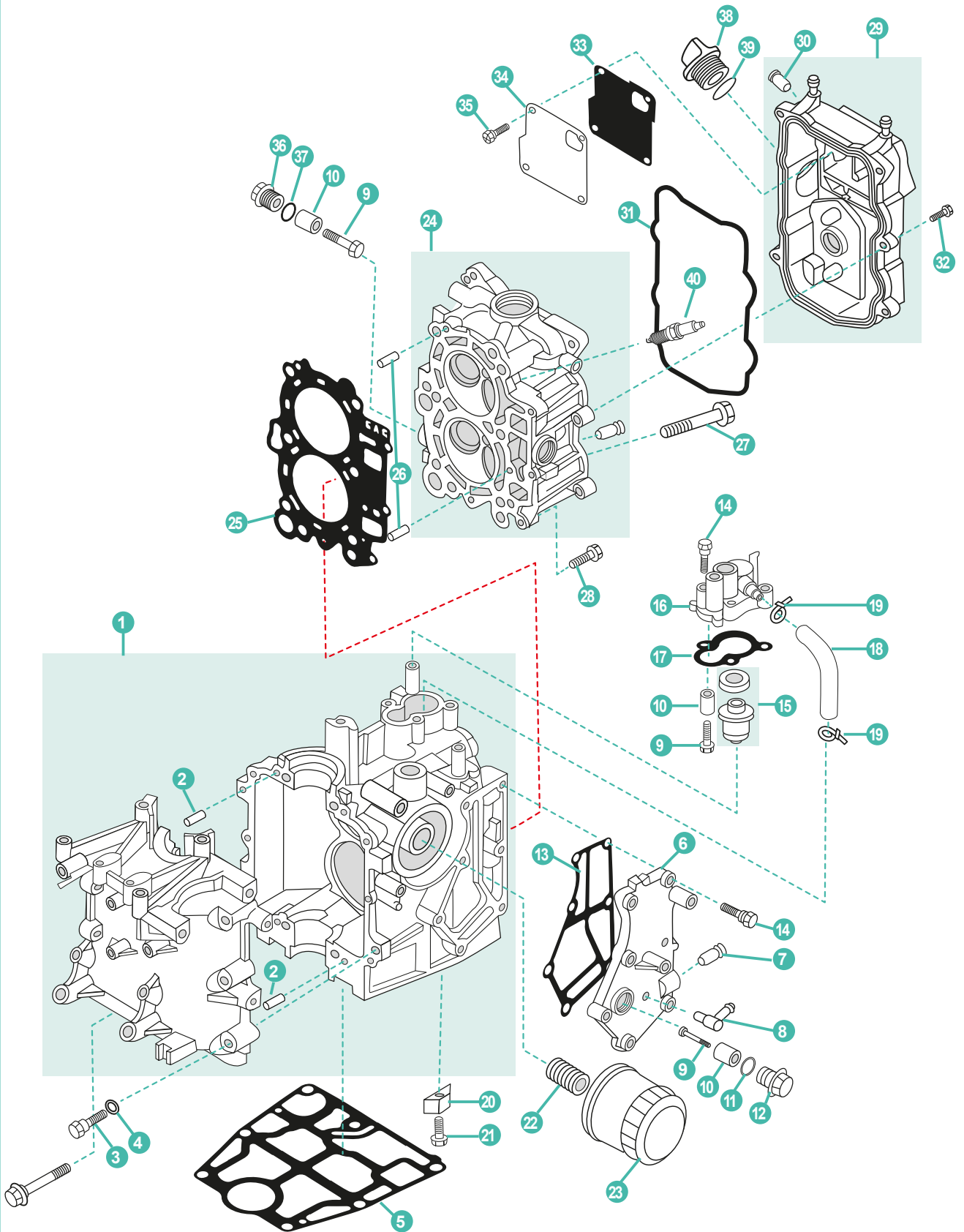

	REF	OEM				UN.	
1	PAF20-05010000	6AH-15100-00	CÁRTER COMPLETO	CRANKCASE ASSY	CARTER COMPLETO	CARTER BLOC MOTEUR	1
2	REC93606-12019	93606-12019	PIN CENTRADOR	HOLLOW PIN	SPINOTTO DI CENTRAGGIO	PIN DE CENTRAGE	4
3	PAF20-05010007	97013-06040	PERNO	BOLT	BULLONE	BOULON	6
4	PAGB/T97.1-6	92903-06600	ARANDELA	WASHER	RONDELLA	RONDELLE	6
5	REC6AH-11351-00	6AH-11351-10	JUNTA DE ESCAPE	EXHAUST GASKET	GUARNIZIONE DI SCARICO	JOINT D'ÉCHAPPEMENT	1
6	PAF20-05000600	6AH-41113-01-1S	CUBIERTA DE ESCAPE	EXHAUST COVER	COPERCHIO SCARICO	COUVERCLE D'ÉCHAPPEMENT	1
7	PAF4-04010102	6E9-24378-00	PIPA DE AGUA	PIPE, WATER	TUBO	RACCORD TUYAU D'EAU	1
8	PAF15-04000005	6H1-11372-00	NIPLE DE MANGUERA	NIPPLE	TUBO	RACCORD D'EAU	1
9	PAGB/T818-M5X25	98980-05025	TORNILLO	SCREW	VITE	VIS	4
10	CM6G8-11325-00A	6G8-11325-00	ÁNODO	ANODE	ANODO	ANODE	4
11	PAGB/T3452.1-13X2	93210-13M63	ANILLO	O-RING	O-RING	TORIQUE	1
12	PAF20-05030009	6G8-11197-A0	TAPÓN	CAP	TAPPO	BOUCHON	1
13	PAF20-05000602	6AH-41114-00	JUNTA DE ESCAPE	EXHAUST GASKET	GUARNIZIONE DI SCARICO	JOINT D'ÉCHAPPEMENT	1
14	PAGB/T5783-M6X25	90119-06MA3	TORNILLO	SCREW	VITE	VIS	3
15	REC6AH-12411-00	6AH-12411-00	TERMOSTATO	THERMOSTAT	TERMOSTATO	THERMOSTAT	1
16	PAF20-05000700	6AH-12413-00-1S	TAPA TERMOSTATO	COVER, THERMOSTAT	COPERCHIO TERMOSTATO	COUVERCLE DE THERMOSTAT	1
17	PAF20-05000702	6AH-12414-00	JUNTA	GASKET	GUARNIZIONE	JOINT	1
18	PAF20-05000016	6AH-12481-00	TUBO DE AGUA	WATER TUBE	TUBO DELL'ACQUA	DURITE D'EAU	1
19	PAHT2.5X50	90465-11M10	BRIDA	CLAMP	FLANGIA	COLLIER	2
20	CM15026A	6E5-11325-00	ÁNODO	ANODE	ANODO	ANODE	1
21	PAGB/T820-M4X12	98780-04016	TORNILLO	SCREW	VITE	VIS	1
22	PAF15-07010003	6C5-12858-00	PERNO	STUD	BULLONE	BOULON	1
23	REC5GH-13440-60	5GH-13440-60	FILTRO ACEITE	OIL FILTER	FILTRO DELL'OLIO	FILTRE À HUILE	1
24	PAF20-05030100	6AH-11111-10-1S	CULATA	CYLINDER HEAD	TESTATA	CULASSE	1
25	REC6AG-11181-00	6AG-11181-10	JUNTA CULATA	GASKET, CYLINDER HEAD	GUARNIZIONE TESTATA	JOINT DE CULASSE	1
26	REC93606-12019	93606-12019	PIN CENTRADOR	HOLLOW PIN	SPINOTTO DI CENTRAGGIO	PIN DE CENTRAGE	2
27	PAF20-05000002	90105-090006	TORNILLO	SCREW	VITE	VIS	6
28	PAF8-05000022	90119-06MA3	TORNILLO	SCREW	VITE	VIS	3
29	PAF20-05040000	6AH-11191-001S	TAPA DE CULATA COMPLETA	CYLINDER HEAD COVER ASSY	COPERCHIO TESTATA COMPLETA	CACHE CULBUTEUR COMPLÈTE	1
30	PAF20-05040005	6AH-11372-00	NIPLE DE MANGUERA	NIPPLE	TUBO	RACCORD D'EAU	1
31	PAF20-05040002	6AH-11356-00	RETÉN DE ACEITE	OIL SEAL	PARAOLIO	JOINT D'HUILE	1
32	PAGB/T5783-M6X20	97595-06520	PERNO	STUD	BULLONE	BOULON	5
33	PAF20-05040003	6AH-11168-00	CUBIERTA DE RESPIRADERO	COVER, BREATHER	COPERCHIO	PLAQUE	1
34	PAF20-05040004	6AH-11169-00	JUNTA DE CUBIERTA	GASKET, BREATHER	GUARNIZIONE COPERCHIO	JOINT DE PLAQUE	1
35	PAGB/T818-M4X10	97607-04210	TORNILLO	SCREW	VITE	VIS	4
36	PAF20-05030009	6G8-11197-A0	TAPÓN	CAP	TAPPO	BOUCHON	2
37	PAGB/T3452.1-13X2	93210-13M63	ANILLO	O-RING	O-RING	TORIQUE	2
38	PAF15-07050004	6G8-15363-00	TAPÓN DE ACEITE	OIL CAP	TAPPO OLIO	BOUCHON REMPLISSAGE D'HUILE	1
39	PAJASOF40431-025	93210-24M79	ANILLO	O-RING	O-RING	TORIQUE	1
40	NGKDPR6EB-9	94702-00418	BUJÍA	SPARK PLUG	CANDELA	BOUGIE	2



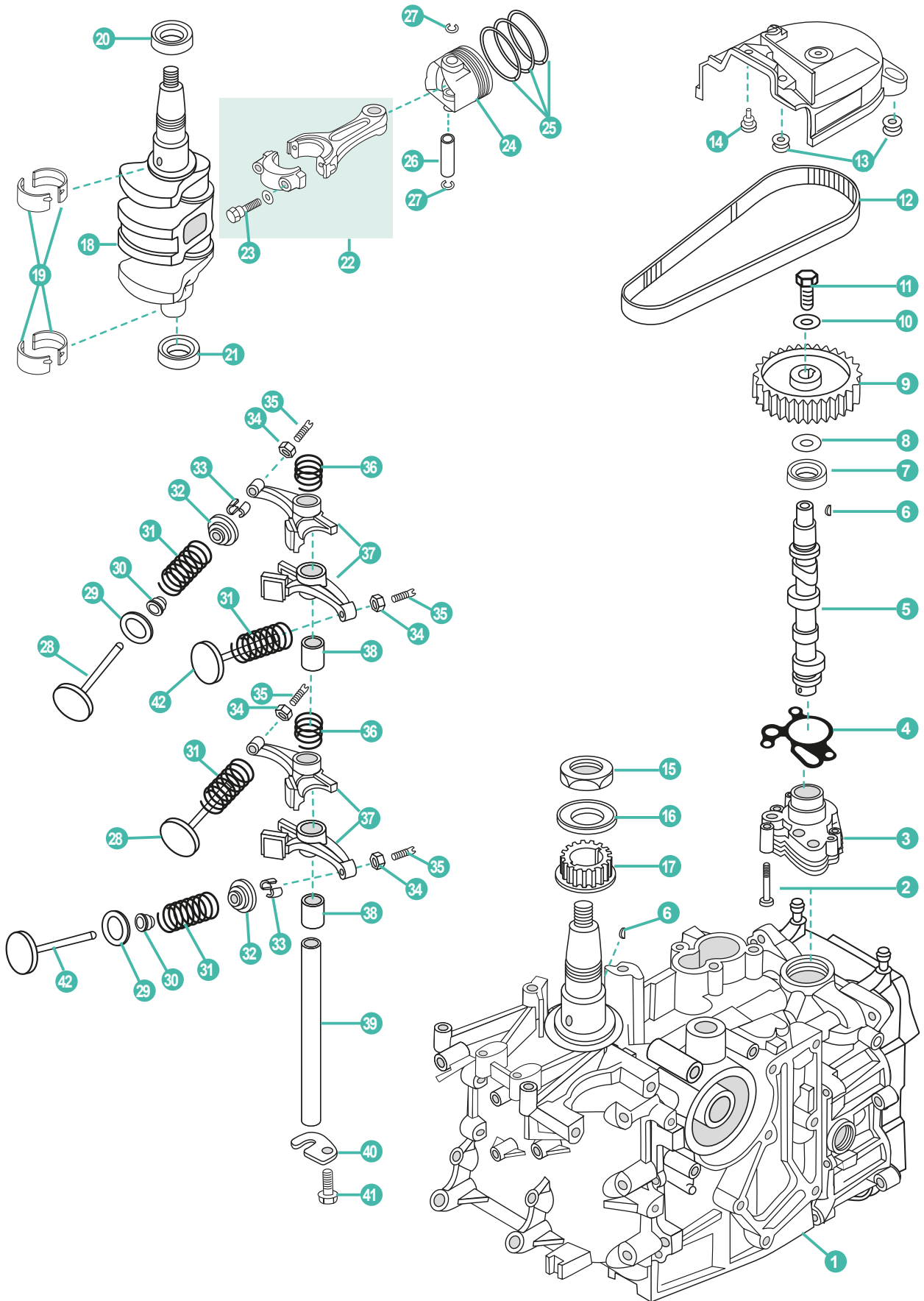

	REF	OEM				UN.	
1	PAF20-0500000	6AH-W009B-02-15	CILINDRO BLOQUE COMPLETO	POWER HEAD ASSY	BLOCCO COMPLETO	TÊTE MOTRICE	1
2	PAGB/T5783-M6X35	90105-06035	TORNILLO	SCREW	VITE	VIS	3
3	PAF20-05030400	6AH-13300-00	BOMBA DE ACEITE	OIL PUMP	POMPA DELL'OLIO	POMPE À HUILE	1
4	PAF20-05030010	6AH-13329-10	JUNTA TAPA	GASKET, COVER	GAURNIZIONE COPERCHIO	JOINT COUVERCLE	1
5	PAF20-05030200	6AH-12170-00	ÁRBOL DE LEVAS	CAMSHAFT ASSY	ALBERO A CAMME	ARBRE À CAMES	1
6	PAGB/T1099-3X5X13	90280-03M01	CUÑA	KEY WOODRUFF	CHIAVETTA	CLAVETTE	2
7	PAF20-05030005	93102-22010	RETÉN DE ACEITE	OIL SEAL	PARAOLIO	JOINT D'HUILE	1
8	PAF20-05030011	90201-15423	ARANDELA	WASHER	RONDELLA	RONDELLE	1
9	PAF20-05030012	6AH-11537-00	POLEA DE CORREA	BELT PULLEY, DRIVEN	PULEGGIA CINGHIA	POULIE DE COURROIE	1
10	PAF20-05030013	90201-08784	ARANDELA	WASHER	RONDELLA	RONDELLE	1
11	PAGB/T5783-M8X25	90105-081A7	TORNILLO	SCREW	VITE	VIS	1
12	PAF20-05000003	6AH-46241-00	CORREA	BELT	CINGHIA	COURROIE	1
13	PAF20-05000034	90480-10627	TAPÓN	CAP	TAPPO	BOUCHON	3
14	PAF20-05000036	90480-06M19	TAPÓN	CAP	TAPPO	BOUCHON	1
15	PAF20-05000029	90170-30003	TUERCA	NUT	DADO	ÉCROU	1
16	PAF20-05000028	6AH-11557-00	ARANDELA	WASHER	RONDELLA	RONDELLE	1
17	PAF20-05000027	6AH-11536-00	ENGRANAJE DE DISTRIBUCIÓN	BELT PULLEY, TIMING	PULEGGIA DE DISTRIBUZIONE	POULIE DE DISTRIBUTION	1
18	PAF20-05020004	6AH-11411-00	CIGÜEÑAL	CRANK ASSY	ALBERO MOTORE	VILEBREQUIN	1
19	PAF20-05010003	6AH-11416-00	COJINETE BANCADA	MAIN BEARING	CUSCINETTO	PALIER DE VILEBREQUIN	1
20	PAF25-05050021	93102-37004	RETÉN DE ACEITE	OIL SEAL	PARAOLIO	JOINT D'HUILE	1
21	PAF15-07030006	93102-25014	RETÉN DE ACEITE	OIL SEAL	PARAOLIO	JOINT D'HUILE	1
22	PAF20-05020200	6AH-11650-10	BIELA	ROD, CONNECTING	BIELLA	BIELLE	2
23	PAF25-05020204	6AH-11654-00	TORNILLO	SCREW	VITE	VIS	2
24	PAF20-05020001	6AH-11631-00	PISTÓN STD	PISTON STD	PISTONE STD	PISTON STD	2
25	PAF20-05020100	6AH-11603-00	KIT SEGMENTOS DE PISTÓN STD	PISTON RING KIT STD	KIT FASCIA PISTONE STD	KIT SEGMENTS STD	2
26	PAF20-05020003	137-11633-10	PIN, PISTÓN	PIN, PISTON	SPINOTTO PISTONE	AXE DE PISTON	2
27	PAF20-05020002	93450-17129	CIRCLIP	CIRCLIP	CIRCLIP	CIRCLIP	4
28	PAF20-05030001	6AH-12111-00	VÁLVULA ADMISIÓN	VALVE, INTAKE	VALVOLA ASPIRAZIONE	SOUPAPE D ADMISSION	2
29	PAF20-05030003	62Y-12116-00	ARANDELA DE ASIENTO	SEAT, VALVE SPRING	RONDELLA BASAMENTO	SIEGE RESSORT DE SOUPAPE	4
30	PA166F-010003	51Y-12119-00	RETÉN DE ACEITE	OIL SEAL	PARAOLIO	JOINT D'HUILE	4
31	PAF20-05030004	3YF-12113-00	MUELLE DE VÁLVULA	SPRING, VALVE STEM	MOLLA DI VALVOLA	RESSORT DE SOUPAPE	4
32	PAF15-07040006	30X-12117-00	RETÉN RESORTE	SPRING, VALVE RETAINER	VALVOLA DI RITEGNO	JOINT DE RESSORT	4
33	PAF15-07040007	30X-12118-00	SEGURO DE VÁLVULA	CLAMP, VALVE	BLOCCAGGIO DI VALVOLA	CLAVETTE DE SOUPAPE	8
34	PAF15-07040304	62Y-12158-00	TUERCA	LOCK NUT	DADO	ÉCROU	4
35	PAF15-07040303	64J-12159-00	TORNILLO REGULADOR	SCREW, VALVE ADJUSTING	VITE REGOLATORE	VIS POINTEAU	4
36	PAF20-05030007	90501-120A5	RESORTE DE COMPRESIÓN	SPRING, ROCKER	MOLLA	RESSORT ROCKER	2
37	PAF20-05030301	6AH-12151-00	BRAZO DE BALANCÍN	ARM, VALVE ROCKER	BILANCERE	CULBUTEUR	4
38	PAF20-05030006	90387-13006	ESPACIADOR	COLLAR	DISTANZIALE	ENTRETOISE	2
39	PAF15-07040015	66M-12146-00	EJE DE BALANCÍN	SHAFT, ROCKER	ASSE DE BILANCERE	AXE DE CULBUTEUR	1
40	PAF20-05030008	6AH-12279-00	PLACA	PLATE	PIASTRA	PLAQUE	1
41	PAGB/T5783-M6X12	97013-06012	TORNILLO	SCREW	VITE	VIS	1
42	PAF20-05030002	6AH-12121-10	VÁLVULA ESCAPE	VALVE, EXHAUST	VALVOLA SCARICO	SOUPAPE D'ECHAPPEMENT	2



4T FT • F20 • F25 (1998-08)  
STROKES

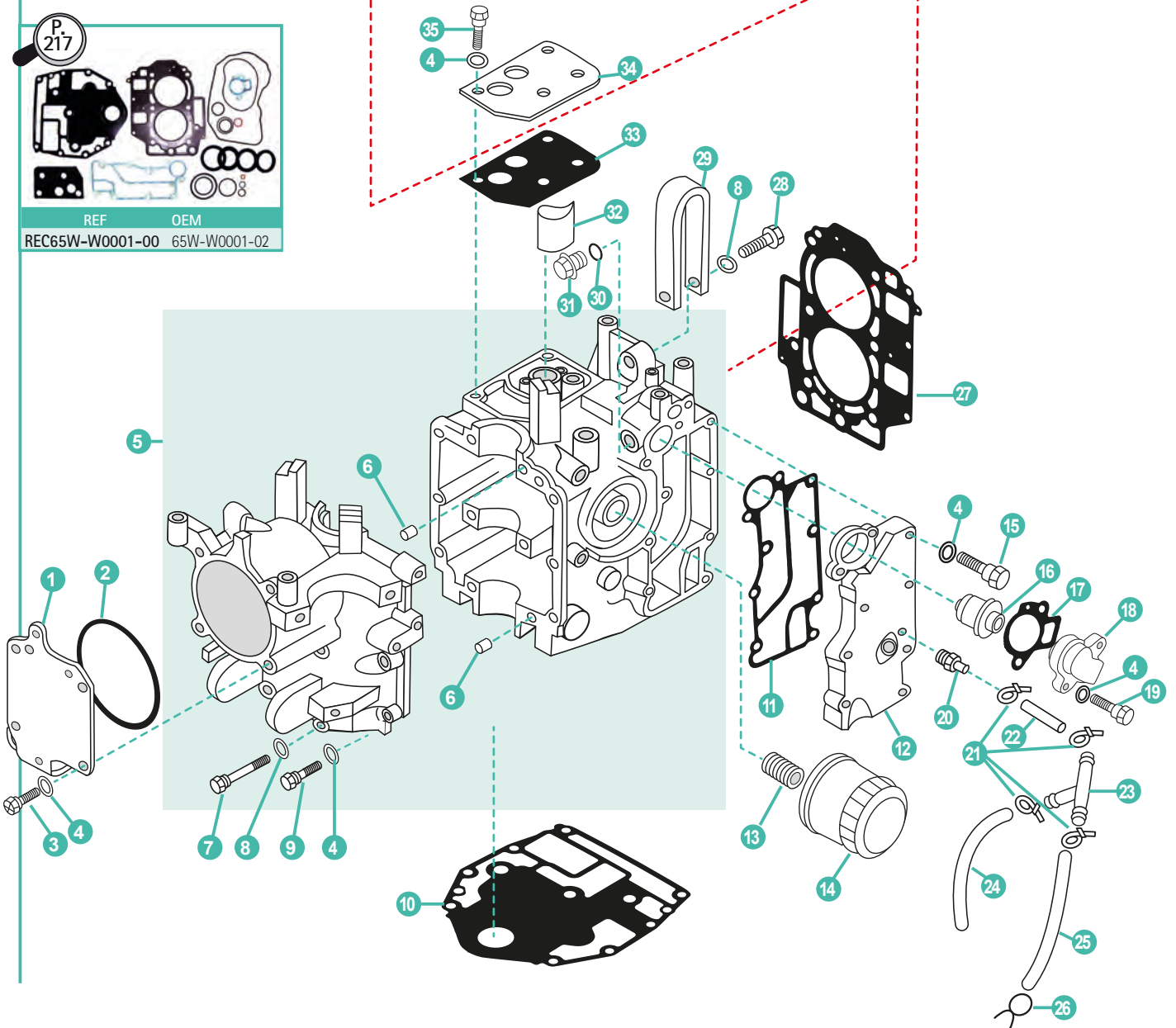
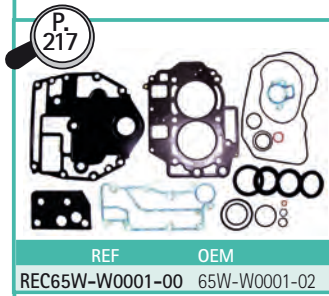
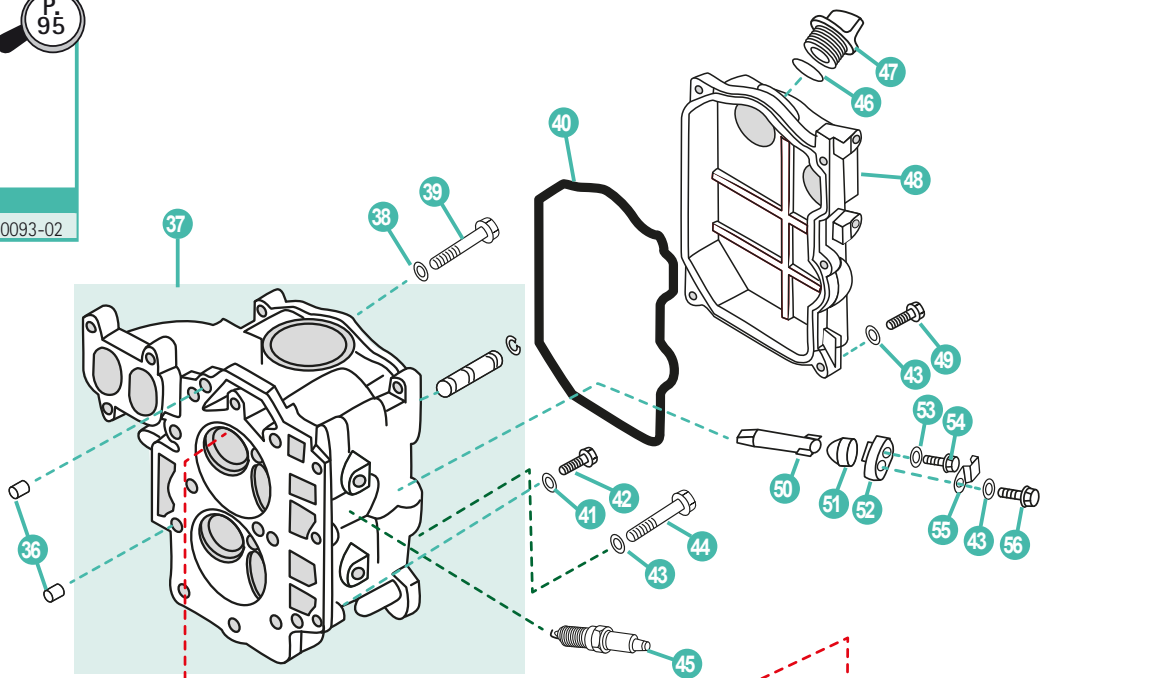
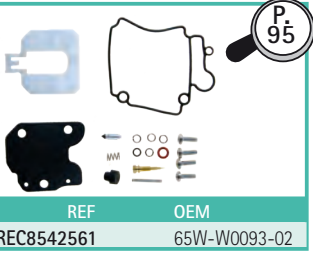

	REF	OEM				UN.	
1	PAF25-05000007	65W-15121-00	TAPA	COVER	COPERCHIO	COUVERCLE	1
2	PAGBT3452.1-97.5X1.8	65W-15663-00	JUNTA	SEAL	GUARNIZIONE	JOINT	1
3	PAGB/T5783-M6X20	65W-12228-00	TORNILLO	BOLT, HEXAGON	VITE	VIS	4
4	PAGB/T97.1-8	66M-11356-00	ARANDELA	WASHER 6	RONDELLA	RONDELLE	17
5	PAF25-05010000	65W-15100-00-94	BLOQUE MOTOR COMPLETO	CRANKCASE ASSY	BLOCCO MOTORE COMPLETO	CARTER BLOC MOTEUR	1
6	PAF25-00000014	99530-08012	PIN CENTRADOR	HOLLOW PIN	SPINOTTO DI CENTRAGGIO	PIN DE CENTRAGE	2
7	PAGB/T5782-M8X80	90119-08M01	TORNILLO	BOLT, HEXAGON	VITE	VIS	6
8	PAGB/T97.1-8	97595-06520	ARANDELA	WASHER	RONDELLA	RONDELLE	7
9	PAGB/T5782-M6X35	90119-06MA5	TORNILLO	BOLT, HEXAGON	VITE	VIS	6
10	PAF25-00000013	65W-11351-00	JUNTA BASE MOTOR	GASKET ENGINE	GUARNIZIONE BASE MOTORE	JOINT MOTEUR	1
11	PAF25-05010111	65W-41114-00	JUNTA EXTERIOR, TAPA DE ESCAPE	GASKET, EXHAUST OUTER COVER	GUARNIZIONE ESTERIORE, COPERCHIO SCARICO	JOINT DE COUVERCLE EXT ECHAPPEMENT	1
12	PAF25-05010112	65W-41113-01-94	TAPA EXTERIOR DE ESCAPE	OUTTER COVER, EXHAUST	COPERCHIO SCARICO	COUVERCLE D'ECHAPPEMENT	1
13	PAF15-07010003	90401-20M00	TORNILLO	BOLT, UNION	VITE	VIS	1
14	PAF25-05000100	5GH-13440-00	FILTRO ACEITE	OIL FILTER	FILTRO DELL'OLIO	FILTRE À HUILE	1
14	REC5GH-13440-00	5GH-13440-00	FILTRO ACEITE	OIL FILTER	FILTRO DELL'OLIO	FILTRE À HUILE	1
15	PAGB/T5783-M6X35	90119-06MAS	TORNILLO	BOLT	VITE	VIS	7
16	PAF15-07000031	6G8-12411-02	TERMOSTATO	THERMOSTAT	TERMOSTATO	THERMOSTAT	1
17	PAF15-07010022	62Y-12414-00	JUNTA TAPA TERMOSTATO	GASKET, THERMOSTAT COVER	GUARNIZIONE COPERCHIO TERMOSTATO	JOINT COUVERCLE DE THERMOSTAT	1
18	PAF15-07010021	6H3-12413-00-9M	TAPA TERMOSTATO	COVER, THERMOSTAT	COPERCHIO TERMOSTATO	COUVERCLE DE THERMOSTAT	1
19	PAGB/T5783-M6X25	90119-06MA5	TORNILLO	BOLT	VITE	VIS	2
20	PAF25-05010113	62Y-11372-01	NIPLE DE MANGUERA	NIPPLE	TUBO	RACCORD D'EAU	1
21	PAHT-2.5x60	90465-11M10	BRIDA	CLAMP	FLANGIA	COLLIER	5
22	PAF25-03000008	90445-09068	TUBO DE AGUA	WATER TUBE	TUBO DELL'ACQUA	DURITE D'EAU	1
23	PAF15-05000011	688-24378-00	CONECTOR DE 3 VÍAS	THREE-WAY PIPE	CONNETTORE T	TE	1
24	PAF25-03000009	90445-09095	TUBO DE AGUA	WATER TUBE	TUBO DELL'ACQUA	DURITE D'EAU	1
25	PAF25-03000011	90445-09105	TUBO DE AGUA	WATER TUBE	TUBO DELL'ACQUA	DURITE D'EAU	1
26	PAF4-04000030	90467-09M09	MUELLE TUBO COMBUSTIBLE B	SPRING, FUEL PIPE B	MOLLA TUBO COMBUSTIBILE B	RESSORT, TUYAU DE CARBURANT	1
27	PAF25-05040000	65W-11181-30	JUNTA CULATA	GASKET, CYLINDER HEAD	GUARNIZIONE TESTATA	JOINT DE CULASSE	1
28	PAGB/T5782-M8X35	65W-08M87	TORNILLO	BOLT, HEXAGON	VITE	VIS	1
29	PAF25-05010106	66W-11119-00	SOPORTE	HANGER, ENGINE	SUPPORTO	CROCHET LEVAGE MOTEUR	1
30	PAF15-04000003	90430-14M09	ARANDELA	WASHER	RONDELLA	RONDELLE	1
31	PAF15-04000002	90340-14M06	TORNILLO DRENAJE	BOLT, DISCHARGING OIL	VITE DRENAGGIO	VIS DE VIDANGE	1
32	PAF25-05010107	65W-13286-00	FILTRO ACEITE	OIL FILTER	FILTRO DELL'OLIO	FILTRE À HUILE	1
33	PAF25-05010108	65W-11169-00	JUNTA DE CUBIERTA	GASKET, BREATHER	GUARNIZIONE COPERCHIO	JOINT DE PLAQUE	1
34	PAF25-05010103	65W-11168-00	CUBIERTA DE RESPIRADERO	COVER, BREATHER	COPERCHIO	PLAQUE	1
35	PAGB/T5783-M6X20	65W-12228-00	TORNILLO	BOLT, HEXAGON	VITE	VIS	4
36	PAF25-00000014	99530-08012	PIN CENTRADOR	HOLLOW PIN	SPINOTTO DI CENTRAGGIO	PIN DE CENTRAGE	2
37	PAF25-05050100	65W-11111-02-94	CULATA	CYLINDER HEAD	TESTATA	CULASSE	1
38	PAF25-05050007	90430-06014	JUNTA	GASKET	GUARNIZIONE	JOINT	1
39	PAF25-05050006	90109-06M65	TORNILLO	BOLT	VITE	VIS	1
40	PAF25-05000004	65W-11356-00	JUNTA TAPA	GASKET, COVER	GAURNIZIONE COPERCHIO	JOINT COUVERCLE	1
41	PAGB/T97.1-8	97595-06520	ARANDELA	WASHER, PLATE	RONDELLA	RONDELLE	10
42	PAGB/T5783-M6X25	90119-06MA3	TORNILLO	BOLT, HEXAGON	VITE	VIS	6
43	PAF25-05000003		ARANDELA	WASHER, PLATE	RONDELLA	RONDELLE	10
44	PAF25-05000002	90119-09M00	TORNILLO	BOLT, FLANGE	VITE	VIS	9
45	NGKDPR7EA-9	94701-00375	BUJÍA	SPARK-PLUG	CANDELA	BOUGIE	2
46	PAJASOF40431-025	93210-24M79	TÓRICA	O-RING	O-RING	TORIQUE	1
47	PAF15-07050004	6G8-15363-00	TAPÓN ACEITE	PLUG, OIL	TAPPO OLIO	BOUCHON REMPLISSAGE D'HUILE	1
48	PAF25-05000005	65W-11191-00-94	TAPA BALANCINES	COVER, CYLINDER HEAD	COPERCHIO PUNTERIE	CACHE CULBUTEUR	1
49	PAGB/T5783-M6X20	90119-06MA3	TORNILLO	BOLT, HEXAGON	VITE	VIS	5
50	PAF25-02010005	62Y-11325-00	ÁNODO	ANODE	ANODO	ANODE	2
51	PAF15-07010009	66M-11328-00	ALOJAMIENTO ÁNODO	GROMMET, ANODE	ALLOGGIAMENTO ANODO	JOINT D'ANODE	2
52	PAF15-07010011	66M-11327-00-94	TAPA	COVER, ANODE	COPERTURA ANODO	COUVERCLE DU ANODE	2
53	PAGB/T97.1-5	92995-05600	ARANDELA	WASHER, PLATE	RONDELLA	RONDELLE	2
54	PAGB/T5783-M5X12	97095-05012	TORNILLO	BOLT, HEXAGON	VITE	VIS	2
55	PAF15-07010012	66M-12535-00	PLETINA	PLATE, ANODE	PIASTRA ANODO	PLAQUE	2
56	PAGB/T5783-M6X20	97095-06020	TORNILLO	BOLT, HEXAGON	VITE	VIS	2

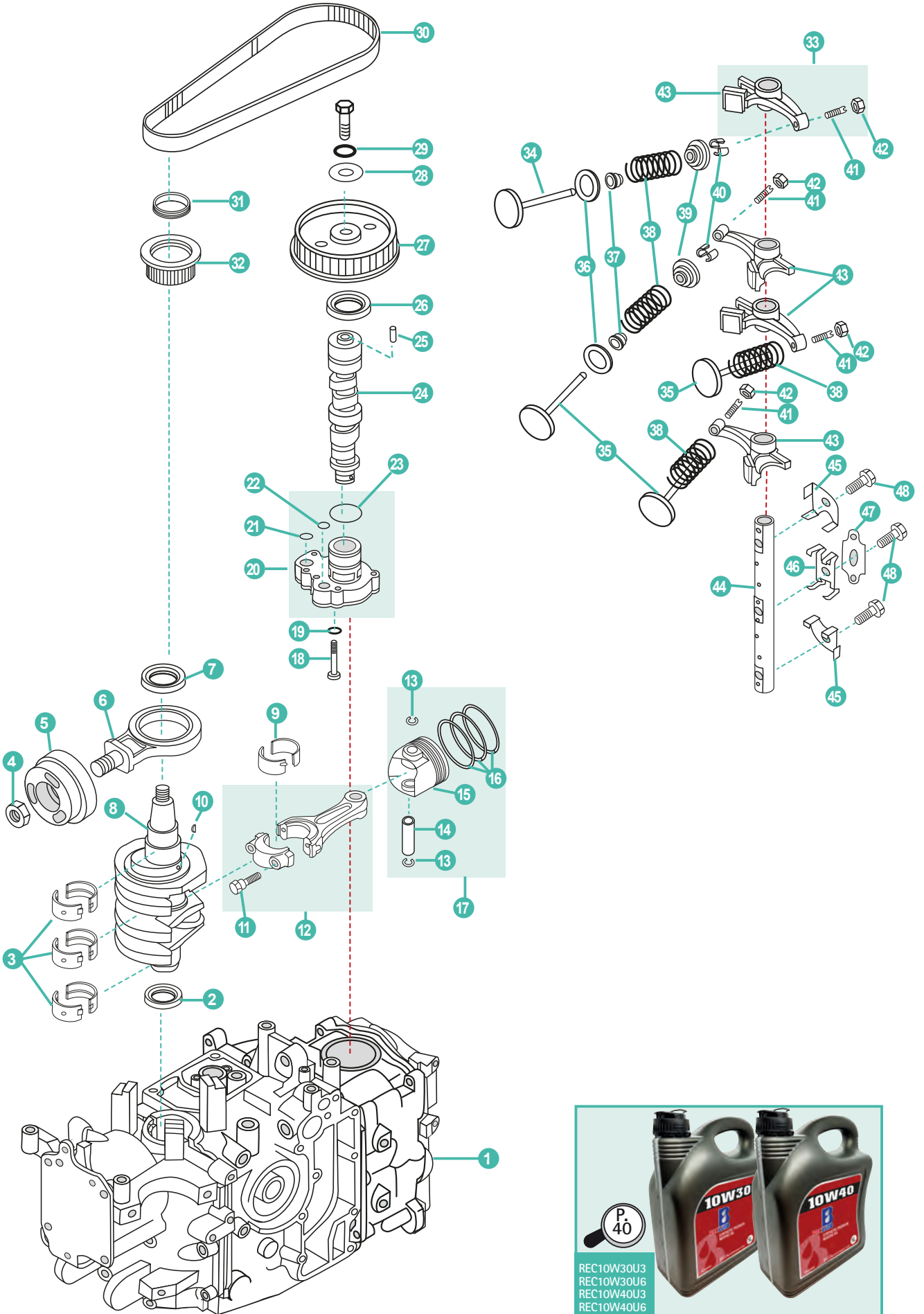

	REF	OEM				UN.	
1	POWERHEAD20-25		MOTOR	COMPLETE, POWER	BLOCCO COMPLETO	TÊTE MOTRICE	1
2	PAF25-05020002	93102-35M47	RETÉN	OIL-SEAL	GUARNIZIONE	JOINT D'HUILE	1
3	PAF25-05010302-1	62Y-11416-00	COJINETE BANCADA BROWN	MAIN BEARING BROWN	CUSCINETTO BROWN	PALIER DE VILEBREQUIN BROWN	6
3	PAF25-05010302-2	62Y-11416-10	COJINETE BANCADA BLACK	MAIN BEARING BLACK	CUSCINETTO BLACK	PALIER DE VILEBREQUIN BLACK	6
4	PAF25-05000026	90170-35M47	TUERCA	LOCK NUT	DADO	ÉCROU	1
5	PAF25-05020301	65W-11642-11	PISTÓN, CONTRA	PISTON, BALANCE	PISTONE, CONTRO	PISTON D'EQUILIBRAGE	1
6	PAF25-05020310	65W-11665-00	BIELA, CONTRO	CON-ROD ASSY, BALANCE	BIELLA, CONTRO	BIELLE D'EQUILIBRAGE	1
7	PAF25-05020003	93102-43M42	RETÉN	OIL SEAL	PARAOLIO	JOINT SPI	1
8	PAF25-05020001	65W-11411-01	CIGÜEÑAL	CRANK ASSY	ALBERO MOTORE	VILEBREQUIN	1
9	PAF25-05020203-1	62Y-11656-00	COJINETE BIELA	BEARING, CONNECTING ROD	CUSCINETTO BIELLA	PALIER DE BIELLE	2
9	PAF25-05020203-2	62Y-11656-00	COJINETE BIELA	BEARING, CONNECTING ROD	CUSCINETTO BIELLA	PALIER DE BIELLE	2
10	PAF4-04000019	90280-04M06	CUÑA	KEY WOODRUFF	CHIAVETTA	CLAVETTE	1
11	PAF25-05020204	62Y-11654-00	TORNILLO	BOLT, CONNECTING ROD	VITE	VIS	2
12	PAF25-05020200	67C-11650-00	BIELA	CONNECTING ROD	BIELLA	BIELLE	2
13	PAF25-05020106	93450-17129	CLIP	CIRCLIP	CLIP	CIRCLIP	4
14	PAF25-05020105	62Y-11633-00	PIN, PISTÓN	PIN, PISTON	SPINOTTO PISTONE	AXE DE PISTON	2
15	PAF25-05020101	65W-11631-00-96	PISTÓN	PISTON	PISTONE	PISTON	2
16	REC67C-11603-00	67C-11603-00	KIT SEGMENTOS DE PISTÓN	PISTON RING KIT	KIT FASCIA PISTONE	KIT SEGMENTS	2
17	PAF25-05020100	65W-11631-00-96	PISTÓN COMPLETO	PISTON ASSY	PISTONE COMPLETO	PISTON COMPLÈTE	2
18	PAGB/T5782-M6X125	97013-06035	TORNILLO	BOLT	VITE	VIS	4
19	PAGB/T97.1-8	66M-11328-00	ARANDELA	WASHER, PLATE	RONDELLA	RONDELLE	4
20	PAF25-05050400	65W-13300-00	BOMBA ACEITE COMPLETA	OIL PUMP ASSY	POMPA DELL'OLIO COMPLETA	POMPE À HUILE COMPLÈTE	1
21	PAF25-05050014	93210-14515	TÓRICA B	O-RING B	O-RING B	JOINT TORIQUE B	1
22	PAF25-05050013	93210-12MG9	TÓRICA A	O-RING A	O-RING A	JOINT TORIQUE A	1
23	PAF25-05050015	93210-33MH2	TÓRICA C	O-RING C	O-RING C	JOINT TORIQUE C	1
24	PAF25-05050200	65W-12171-10	ÁRBOL DE LEVAS	CAMSHAFT ASSY	ALBERO A CAMME	ARBRE À CAMES	1
25	PAF25-05050016	93605-14143	PIN CENTRADOR	HOLLOW PIN	SPINOTTO DI CENTRAGGIO	PIN DE CENTRAGE	1
26	PAF25-05050021	93102-37M40	RETÉN	OIL SEAL	PARAOLIO	JOINT SPI	1
27	PAF25-05050017	65W-11537-01	POLEA DE CORREA	BELT PULLEY, DRIVEN	PULEGGIA CINGHIA	POULIE DE COURROIE	1
28	PAF25-05050018	90201-10M06	ARANDELA	WASHER, PLATE	RONDELLA	RONDELLE	1
29	PAGB/T97.1-8	97595-06520	ARANDELA	WASHER, PLATE	RONDELLA	RONDELLE	1
30	REC65W-46241-00	65W-46241-00	CORREA DISTRIBUCIÓN	BELT, TIMING	CINGHIA DISTRIBUZIONE	COURROIE DISTRIBUTION	1
31	PAF25-05000022	65W-11476-00	MUELLE	BUSH, SPRING	MOLLA	RESSORT	1
32	PAF25-05000021	65W-11536-10	ENGRANAJE DE DISTRIBUCIÓN	BELT PULLEY, TIMING	PULEGGIA DE DISTRIBUZIONE	POULIE DE DISTRIBUTION	1
33	PAF25-05050300	65W-12151-00	BALANCÍN COMPLETO	ROCKET ASSY	BILANCERE COMPLETO	CULBUTEUR COMPLÈTE	4
34	PAF25-05050002	62Y-12121-00	VÁLVULA ESCAPE	VALVE, EXHAUST	VALVOLA SCARICO	SOUPAPE D'ÉCHAPPEMENT	2
35	PAF25-05050001	67C-12111-00	VÁLVULA ADMISIÓN	VALVE, INTAKE	VALVOLA ASPIRAZIONE	SOUPAPE D'ADMISSION	2
36	PAF25-05050003	62Y-12116-00	ARANDELA ASIENTO	SEAT, VALVE SPRING	RONDELLA BASAMENTO	SIEGE RESSORT DE SOUPAPE	4
37	PAF166-010003	51Y-12119-00	RETÉN DE ACEITE	OIL SEAL	PARAOLIO	JOINT D'HUILE	4
38	PAF25-05050005	51Y-12114-00	MUELLE DE VÁLVULA	SPRING, VALVE STEM	MOLLA DI VALVOLA	RESSORT DE SOUPAPE	4
39	PAF15-07040006	30X-12117-00	RETÉN RESORTE	SPRING, VALVE RETAINER	VALVOLA DI RITEGNO	JOINT DE RESSORT	4
40	PAF15-07040007	30X-12118-00	SEGURO DE VÁLVULA	CLAMP, VALVE	BLOCCAGGIO DI VALVOLA	CLAVETTE DE SOUPAPE	8
41	PAF15-07040303	62Y-12159-00	TORNILLO REGULADOR	SCREW, VALVE ADJUSTING	VITE REGOLATORE	VIS POINTEAU	4
42	PAF15-07040304	62Y-12158-00	TUERCA	NUT	GHIERA	ÉCROU	4
43	PAF25-05050301	65W-12151-00	BALANCÍN	VALVE ROCKER	BILANCERE	CULBUTEUR	4
44	PAF25-05050008	65W-12146-00	EJE DE BALANCÍN	SHAFT, ROCKER	ASSE BILANCERE	AXE DE CULBUTEUR	1
45	PAF25-05050009	62Y-12238-00	PLETINA	PLATE, BOLT STOPPER	PIASTRINA	PLAQUE	2
46	PAF25-05050011	62Y-12216-00	RESORTE	SPRING	MOLLA	RESSORT	1
47	PAF25-05050012	62Y-12231-00	PLETINA	PLATE B, BOLT STOPPER	PIASTRINA	PLAQUE	1
48	PAF25-05050019	90109-08M63	TORNILLO	BOLT	VITE	VIS	3



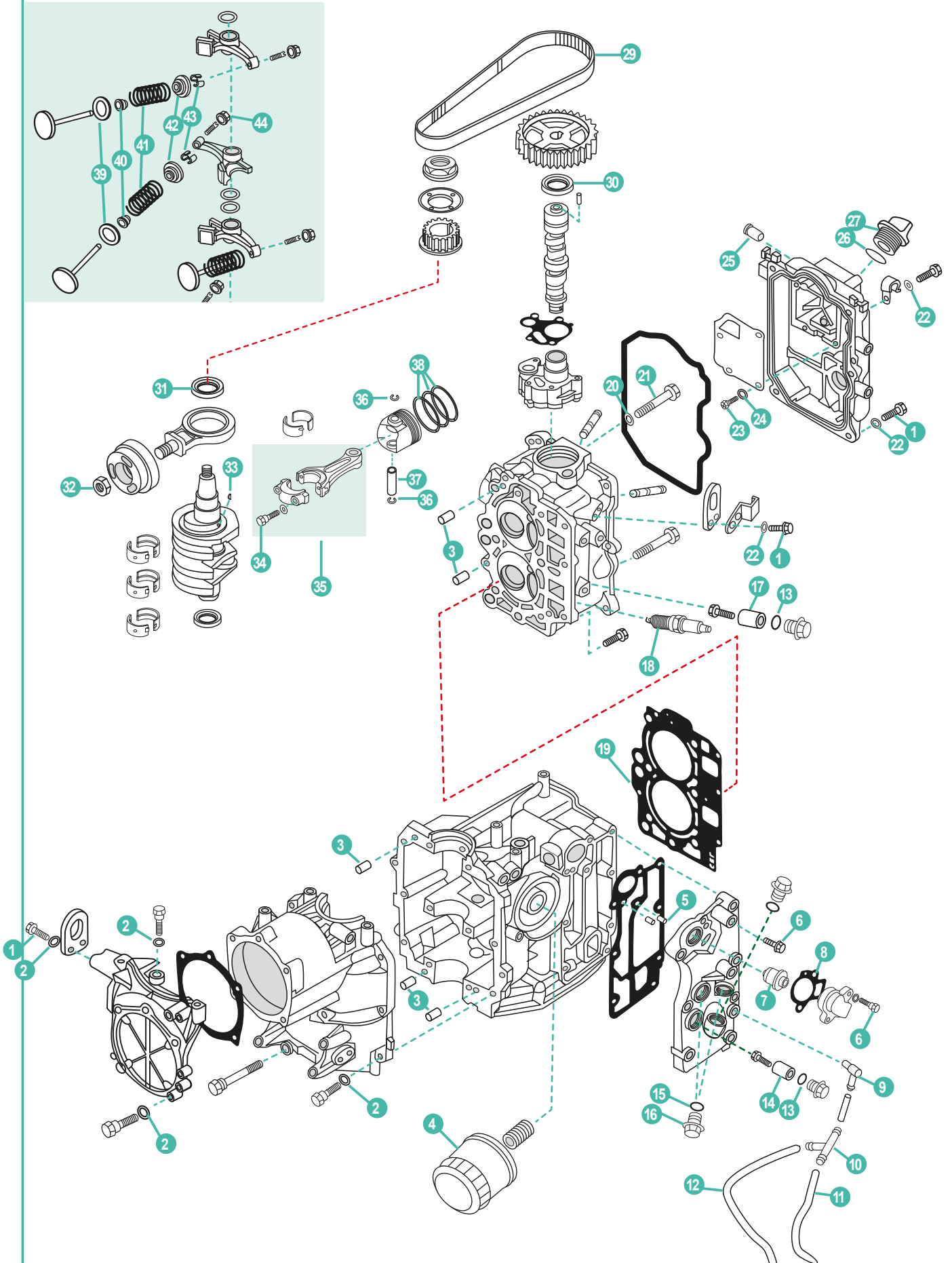

	REF	OEM				UN.	
1	PAGB/T5783-M6X20	97095-06020	TORNILLO	SCREW	VITE	VIS	9
2	PAGB/T97.1-6	92995-06600	ARANDELA	WASHER	RONDELLA	RONDELLE	16
3	REC93606-12019	93606-12019	PIN CENTRADOR	HOLLOW PIN	SPINOTTO DI CENTRAGGIO	PIN DE CENTRAGE	5
4	REC5GH-13440-60	5GH-13440-20	FILTRO ACEITE	OIL FILTER	FILTRO DELL'OLIO	FILTRE À HUILE	1
5	PAF25-04000007	93604-10M03	PIN CENTRADOR	HOLLOW PIN	SPINOTTO DI CENTRAGGIO	PIN DE CENTRAGE	2
6	PAGB/T5783-M6X30	90119-06MA5	TORNILLO	SCREW	VITE	VIS	8
7	PAF15-07000031	6G8-12411-03	TERMOSTATO	THERMOSTAT	TERMOSTATO	THERMOSTAT	1
8	PAF15-07010022	62Y-12414-00	JUNTA TAPA TERMOSTATO	GASKET, THERMOSTAT COVER	GUARNIZIONE COPERCHIO TERMOSTATO	JOINT COUVERCLE DE THERMOSTAT	1
9	PAF15-04000005	676-11372-00	NIPLE DE MANGUERA	NIPPLE	TUBO	RACCORD D'EAU	1
10	PAF15-05000011	688-24378-00	CONECTOR DE 3 VÍAS	THREE-WAY PIPE	CONNETTORE T	TE	1
11	PAF25-03000011	90445-09251	TUBO DE AGUA	WATER TUBE	TUBO DELL'ACQUA	DURITE D'EAU	1
12	PAF25-03000009	90445-09104	TUBO DE AGUA	WATER TUBE	TUBO DELL'ACQUA	DURITE D'EAU	1
13	PAGB/T3452.1-13X2	93210-13M63	TÓRICA	O-RING	O-RING	JOINT TORIQUE	1
14	CM6G8-11325-00A	6G8-11325-00	ÁNODO	ANODE	ANODO	ANODE	1
15	PAF15-04000003	90430-14115	TÓRICA	O-RING	O-RING	JOINT TORIQUE	2
16	PAF15-04000002	90340-14M06	TORNILLO DRENAJE	BOLT, DISCHARGING OIL	VITE DRENAGGIO	BOUCHON DE VIDANGE	2
17	CM6BL-11325-00A	6BL-11325-00	ÁNODO	ANODE	ANODO	ANODE	2
18	NGKDPR6EB-9	94702-00418	BUJÍA	SPARK PLUG	CANDELE	BOUGIE	2
19	REC6BL-11181-00	6BL-11181-00	JUNTA CULATA	GASKET, CYLINDER HEAD	GUARNIZIONE TESTATA	JOINT DE CULASSE	1
20	PAF25-05050007	90430-06014	JUNTA	GASKET	GUARNIZIONE	JOINT	1
21	PAF25-05050006	90109-06M65	PERNO	STUD	BULLONE	BOULON	1
22	PAGB/T96-6	92995-06600	ARANDELA	WASHER	RONDELLA	RONDELLE	8
23	PAGB/T818-M4X10	98507-04010	TORNILLO	SCREW	VITE	VIS	4
24	PAGB/T97.1-4	92907-04600	ARANDELA	WASHER	RONDELLA	RONDELLE	4
25	PAF20-05040005	62Y-14485-00	PIPA DE AGUA	PIPE, WATER	TUBO	RACCORD TUYAU D'EAU	1
26	PAJASOF40431-025	93210-24M79	TÓRICA	O-RING	O-RING	JOINT TORIQUE	1
27	PAF15-07050004	6G8-15363-00	TAPÓN ACEITE	PLUG, OIL	TAPPO OLIO	BOUCHON REMPLISSAGE D'HUILE	1
28	PAF15-07010015	90465-08M83	BRIDA	CLAMP	FLANGIA	COLLIER	1
29	REC6C5-46241-00	6C5-46241-00	CORREA DISTRIBUCIÓN	BELT, TIMING	CINGHIA DISTRIBUZIONE	COURROIE DISTRIBUTION	1
30	PAF25-05050021	93102-37M40	RETÉN DE ACEITE	OIL SEAL	PARAOLIO	JOINT SPI	1
31	PAF25-05020003	93102-43M42	RETÉN DE ACEITE	OIL SEAL	PARAOLIO	JOINT SPI	1
32	PAF25-05000026	90170-20137	TUERCA	LOCK NUT	DADO	ÉCROU	1
33	PAGB/T1099-3X5X13	90280-03M01	CUÑA	KEY WOODRUFF	CHIAVETTA	CLAVETTE	1
34	PAF25-05020204	6C5-11654-00	TORNILLO	SCREW	VITE	VIS	2
35	PAF25-05020200	6C5-11650-00	BIELA COMPELTA	ROD, CONNECTING ASSY	BIELLA COMPLETA	BIELLE COMPLÈTE	2
36	PAF25-05020106	93450-17129	CIRCLIP	CIRCLIP	CIRCLIP	CIRCLIP	4
37	PAF25-05020105	62Y-11633-00	PIN, PISTÓN	PIN, PISTON	SPINOTTO PISTONE	AXE DE PISTON	2
38	REC67C-11603-00	67C-11603-00	KIT SEGMENTOS DE PISTÓN	PISTON RING KIT	KIT FASCIA PISTONE	KIT SEGMENTS	2
39	PAF25-05050003	62Y-12116-00	ARANDELA ASIENTO	SEAT, VALVE SPRING	RONDELLA BASAMENTO	SIEGE RESSORT DE SOUPAPE	4
40	PA166F-010003	51Y-12119-00	RETÉN DE ACEITE	OIL SEAL	PARAOLIO	JOINT D'HUILE	4
41	PAF25-05050005	51Y-12114-00	MUELLE DE VÁLVULA	SPRING, VALVE STEM	MOLLA DI VALVOLA	RESSORT DE SOUPAPE	4
42	PAF15-07040006	30X-12117-00	RETÉN RESORTE	SPRING, VALVE RETAINER	VALVOLA DI RITEGNO	JOINT DE RESSORT	4
43	PAF15-07040007	30X-12118-00	SEGURO DE VÁLVULA	CLAMP, VALVE	BLOCCAGGIO DI VALVOLA	CLAVETTE DE SOUPAPE	8
44	PAF15-07040304	62Y-12158-00	TUERCA	NUT	GHIERA	ÉCROU	1



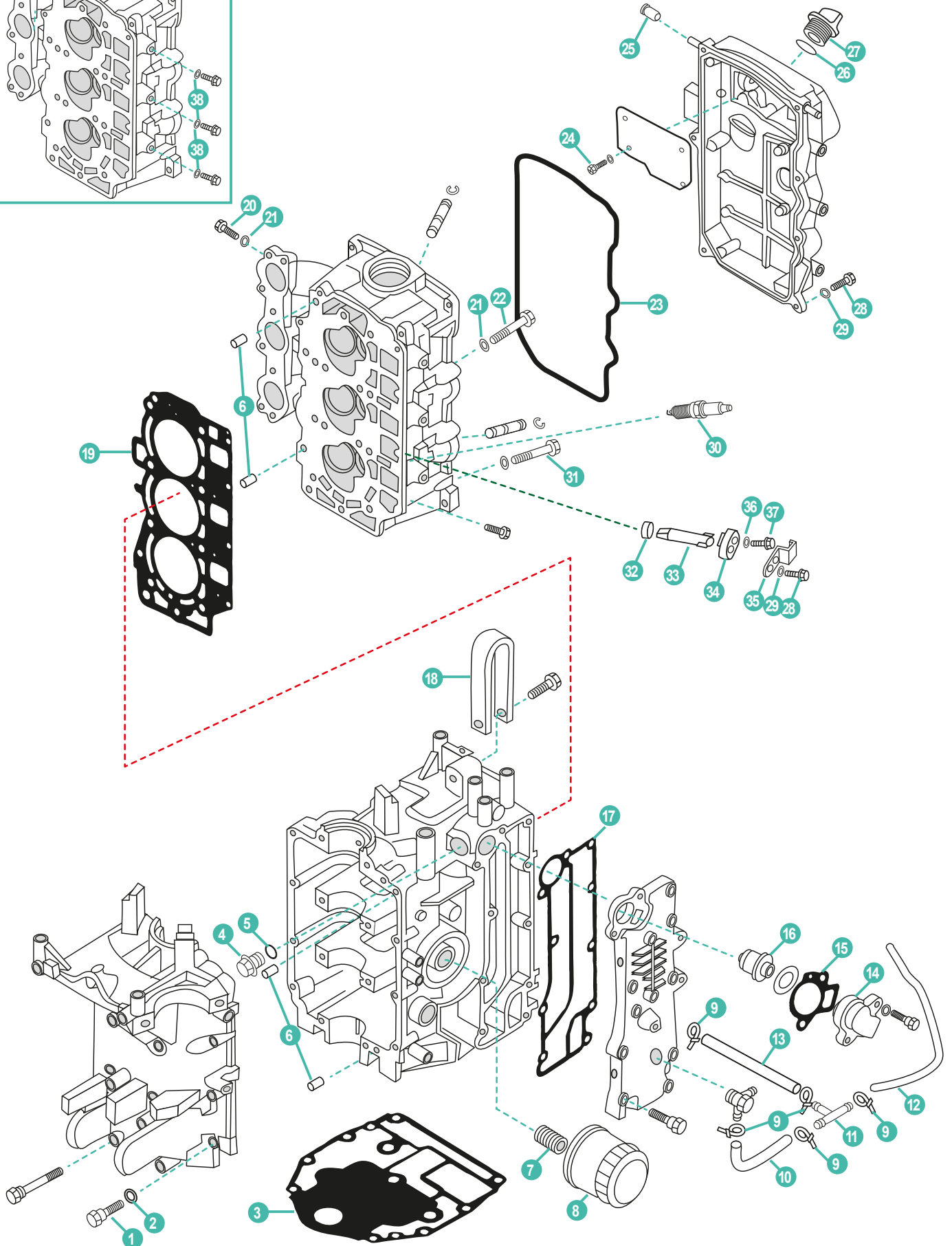
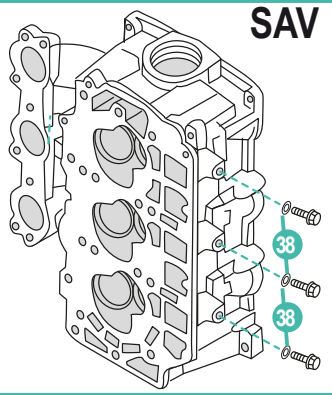

	REF	OEM					UN.
1	PAF15-07000030	97013-06035	TORNILLO	STUD	BULLONE	BOULON	8
2	PAGB/T97.1-6	92903-06600	ARANDELA	WASHER	RONDELLA	RONDELLE	8
3	REC67C-11351-00	67C-11351-01	JUNTA BASE MOTOR	GASKET ENGINE	GUARNIZIONE BASE MOTORE	JOINT MOTEUR	1
4	PAF15-04000002	90340-14M06	TORNILLO DRENAJE	BOLT, DISCHARGING OIL	VITE DRENAGGIO	BOUCHON DE VIDANGE	1
5	PAF15-04000003	90430-14115	TÓRICA	O-RING	O-RING	JOINT TORIQUE	1
6	PAF25-00000014	99530-08012	PIN CENTRADOR	HOLLOW PIN	SPINOTTO DI CENTRAGGIO	PIN DE CENTRAGE	4
7	PAF15-07010003	90401-20M00	PERNO	STUD	BULLONE	BOULON	1
8	REC5GH-13440-00	5GH-13440-00	FILTRO ACEITE	OIL FILTER	FILTRO DELL'OLIO	FILTRE À HUILE	1
9	PAHT-2.5X60	90465-11M10	BRIDA	CLAMP	FLANGIA	COLLIER	5
10	PAF25-03000008	90445-09068	TUBO DE AGUA	WATER TUBE	TUBO DELL'ACQUA	DURITE D'EAU	1
11	PAF15-05000011	688-24378-00	CONECTOR DE 3 VÍAS	THREE-WAY PIPE	CONNETTORE T	TE	1
12	PAF15-05000014	90445-09104	TUBO DE AGUA	WATER TUBE	TUBO DELL'ACQUA	DURITE D'EAU	1
13	PAF25-03000009	90445-09095	TUBO DE AGUA	WATER TUBE	TUBO DELL'ACQUA	DURITE D'EAU	1
14	PAF15-07010021	6H3-12413-00-1S	TAPA TERMOSTATO	COVER, THERMOSTAT	COPERCHIO TERMOSTATO	COUVERCLE DE THERMOSTAT	1
15	PAF15-07010022	62Y-12414-00	JUNTA TAPA TERMOSTATO	GASKET, THERMOSTAT COVER	GUARNIZIONE COPERCHIO TERMOSTATO	JOINT COUVERCLE DE THERMOSTAT	1
16	PAF15-07000031	6G8-12411-03	TERMOSTATO	THERMOSTAT	TERMOSTATO	THERMOSTAT	1
17	REC67C-41114-00	67C-41114-10	JUNTA EXTERIOR, TAPA DE ESCAPE	GASKET, EXHAUST OUTER COVER	GUARNIZIONE ESTERIORE, COPERCHIO SCARICO	JOINT DE COUVERCLE EXT ECHAPPEMENT	1
18	PAF25-05010106	65W-11119-00	SOPORTE	HANGER, ENGINE	SUPPORTO	CROCHET LEVAGE MOTEUR	1
19	REC67C-11181-01	67C-11181-01	JUNTA CULATA	GASKET, CYLINDER HEAD	GUARNIZIONE TESTATA	JOINT DE CULASSE	1
20	PAGB/T5783-M6X10	97095-06010	TORNILLO	SCREW	VITE	VIS	3
21	PAF25-05050007	90430-06014	JUNTA	GASKET	GUARNIZIONE	JOINT	3
22	PAF25-05050006	90109-06M65	PERNO	STUD	BULLONE	BOULON	1
23	REC67C-11356-00	67C-11356-00	JUNTA TAPA	GASKET, COVER	GUARNIZIONE COPERCHIO	JOINT COUVERCLE	1
24	PAGB/T818-M4X10	98507-04010	TORNILLO	SCREW	VITE	VIS	4
25	PAF40-05070002	62Y-14485-00	PIPA DE AGUA	PIPE, WATER	TUBO	RACCORD TUYAU D'EAU	1
26	PAJASOF40431-025	93210-24M79	TÓRICA	O-RING	O-RING	JOINT TORIQUE	1
27	PAF15-07050004	6G8-15363-00	TAPÓN ACEITE	PLUG, OIL	TAPPO OLIO	BOUCHON REMPLISSAGE D'HUILE	1
28	PAGB/T5783-M6X20	97095-06020	TORNILLO	SCREW	VITE	VIS	7
29	PAGB/T97.1-6	92995-06600	ARANDELA	WASHER	RONDELLA	RONDELLE	7
30	NGKDPR6EA-9	94701-00375	BUJÍA	SPARK PLUG	CANDELA	BOUGIE	3
31	PAF25-05000002	90119-09M00	TORNILLO	SCREW	VITE	VIS	8
32	PAF15-07010009	66M-11328-00	TAPÓN	PLUG	TAPPO	BOUCHON	3
33	CM62Y-11325-00A	62Y-11325-00	ÁNODO	ANODE	ANODO	ANODE	3
34	PAF15-07010011	66M-11327-00-94	TAPA ÁNODO	COVER, ANODE	COPERTURA ANODO	COUVERCLE D'ANODE	3
35	PAF15-07010012	66M-12535-00	PLETINA DEL ÁNODO	PLATE, ANODE	PIASTRA ANODO	PLAQUE D'ANODE	3
36	PAGB/T97.1-5	92995-05600	ARANDELA	WASHER	RONDELLA	RONDELLE	3
37	PAGB/T818-M5X12	97095-05012	TORNILLO	SCREW	VITE	VIS	3
38	PAF4-04000006	90430-08143	JUNTA	GASKET	GUARNIZIONE	JOINT	3

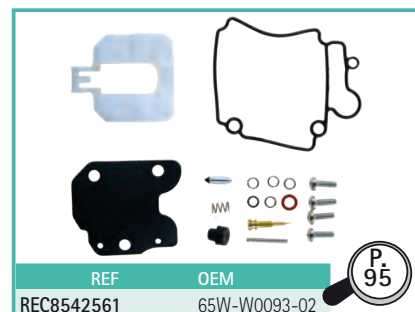
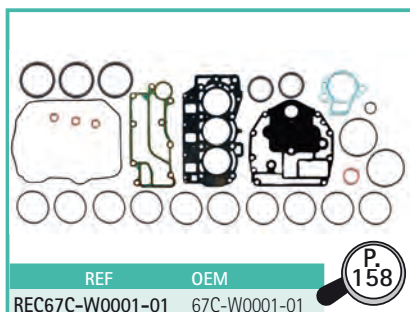



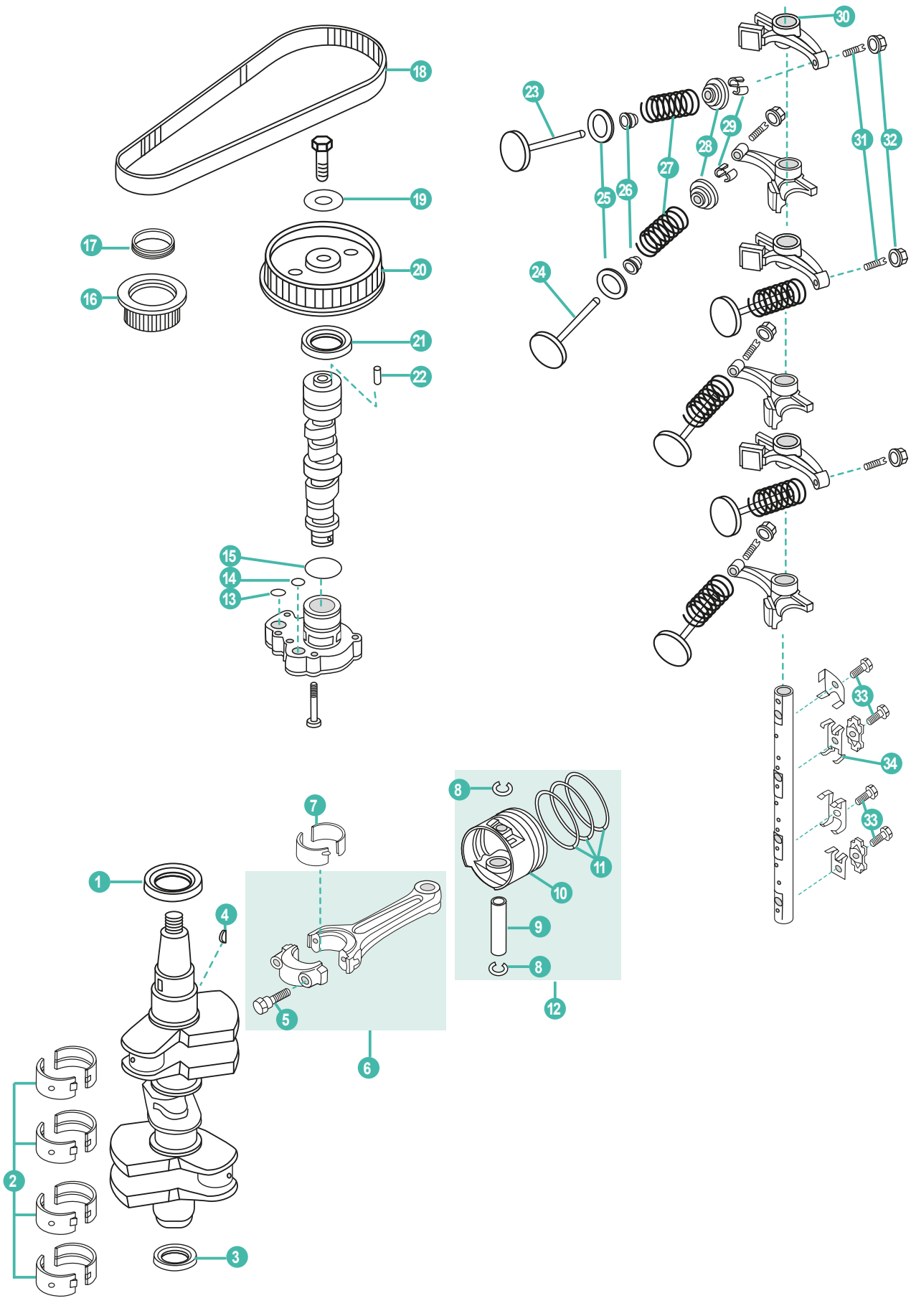

	REF	OEM				UN.	
1	PAF25-05020003	93102-43M42	RETÉN DE ACEITE	OIL SEAL	PARAOLIO	JOINT SPI	1
2	PAF25-05010302-1	62Y-11416-00	COJINETE BANCADA BROWN	MAIN BEARING BROWN	CUSCINETTO BROWN	PALIER DE VILEBREQUIN BROWN	8
	PAF25-05010302-2	62Y-11416-10	COJINETE BANCADA BLACK	MAIN BEARING BLACK	CUSCINETTO BLACK	PALIER DE VILEBREQUIN BLACK	8
3	PAF25-05020002	93102-35M47	RETÉN DE ACEITE	OIL SEAL	PARAOLIO	JOINT SPI	1
4	PAF25-05000024	90280-04M06	CUÑA	KEY WOODRUFF	CHIAVETTA	CLAVETTE	1
5	PAF25-05020204	62Y-11654-00	TORNILLO	SCREW	VITE	VIS	2
6	PAF25-05020200	62Y-11650-10	BIELA COMPLETA	ROD, CONNECTING ASSY	BIELLA COMPLETA	BIELLE COMPLÈTE	3
7	PAF25-05020203-1	62Y-11656-00	COJINETE DE BIELA BROWN	BEARING, CONNECTING ROD BROWN	CUSCINETTO BIELLA BROWN	PALIER DE BIELLE BROWN	6
	PAF25-05020203-2	62Y-11656-10	COJINETE DE BIELA BLACK	BEARING, CONNECTING ROD BLACK	CUSCINETTO BIELLA BLACK	PALIER DE BIELLE BLACK	6
8	PAF25-05020106	93450-17129	CIRCLIP	CIRCLIP	CIRCLIP	CIRCLIP	6
9	PAF25-05020105	62Y-11633-00	PIN, PISTÓN	PIN, PISTON	SPINOTTO PISTONE	AXE DE PISTON	3
10	PAF25-05020101	65W-11631-00-96	PISTÓN	PISTON	PISTONE	PISTON	3
11	REC67C-11603-00	67C-11603-00	KIT SEGMENTOS DE PISTÓN	PISTON RING KIT	KIT FASCIA PISTONE	KIT SEGMENTS	3
12	PAF25-05020100	65W-11631-00-96	KIT PISTÓN	PISTON KIT	KIT PISTONE	KIT PISTON	3
13	PAF25-05050014	93210-14515	TÓRICA	O-RING	O-RING	JOINT TORIQUE	1
14	PAF25-05050013	93210-12MG9	TÓRICA	O-RING	O-RING	JOINT TORIQUE	1
15	PAF25-05050015	93210-33MH2	TÓRICA	O-RING	O-RING	JOINT TORIQUE	1
16	PAF25-05000021	65W-11536-10	ENGRANAJE DE DISTRIBUCIÓN	BELT PULLEY, TIMING	PULEGGIA DE DISTRIBUZIONE	POULIE DE DISTRIBUTION	1
17	PAF25-05000022	65W-11476-00	RESORTE	SPRING	MOLLA	RESSORT	1
18	REC65W-46241-00	65W-46241-00	CORREA DISTRIBUCIÓN	BELT, TIMING	CINGHIA DISTRIBUZIONE	COURROIE DISTRIBUTION	1
19	PAF25-05050018	90201-10M06	ARANDELA	WASHER	RONDELLA	RONDELLE	1
20	PAF40-05040006	67C-11537-01	POLEA DE CORREA	BELT PULLEY, DRIVEN	PULEGGIA CINGHIA	POULIE DE COURROIE	1
21	PAF25-05050021	93102-37M40	RETÉN DE ACEITE	OIL SEAL	PARAOLIO	JOINT SPI	1
22	PAF25-05050016	93605-14143	PIN CENTRADOR	HOLLOW PIN	SPINOTTO DI CENTRAGGIO	PIN DE CENTRAGE	1
23	PAF25-05050002	62Y-12121-00	VÁLVULA ESCAPE	VALVE, EXHAUST	VALVOLA SCARICO	SOUPAPE D'ÉCHAPPEMENT	3
24	PAF25-05050001	67C-12111-00	VÁLVULA ADMISIÓN	VALVE, INTAKE	VALVOLA ASPIRAZIONE	SOUPAPE D'ADMISSION	3
25	PAF25-05050003	62Y-12116-00	ARANDELA ASIENTO	SEAT, VALVE SPRING	RONDELLA BASAMENTO	SIEGE RESSORT DE SOUPAPE	6
26	PAPS2700.04.03	51Y-12119-00	RETÉN DE ACEITE	OIL SEAL	PARAOLIO	JOINT SPI	6
27	PAF25-05050005	51Y-12114-00	MUELLE DE VÁLVULA	SPRING, VALVE STEM	MOLLA DI VALVOLA	RESSORT DE SOUPAPE	6
28	PAF15-07040006	30X-12117-00	RETÉN RESORTE	SPRING, VALVE RETAINER	VALVOLA DI RITEGNO	JOINT DE RESSORT	6
29	PAF15-07040007	30X-12118-00	SEGURO DE VÁLVULA	CLAMP, VALVE	BLOCCAGGIO DI VALVOLA	CLAVETTE DE SOUPAPE	12
30	PAF25-05050301	65W-12151-00	BRAZO DE BALANCÍN	ARM, VALVE ROCKER	BILANCERE	CULBUTEUR	6
31	PAF15-07040303	62Y-12159-00	TORNILLO REGULADOR	SCREW, VALVE ADJUSTING	VITE REGOLATORE	VIS POINTEAU	6
32	PAF15-07040304	62Y-12158-00	TUERCA	LOCK NUT	DADO	ÉCROU	6
33	PAF25-05050019	90109-08M63	TORNILLO	SCREW	VITE	VIS	4
34	PAF25-05050011	62Y-12216-00	RESORTE	SPRING	MOLLA	RESSORT	1

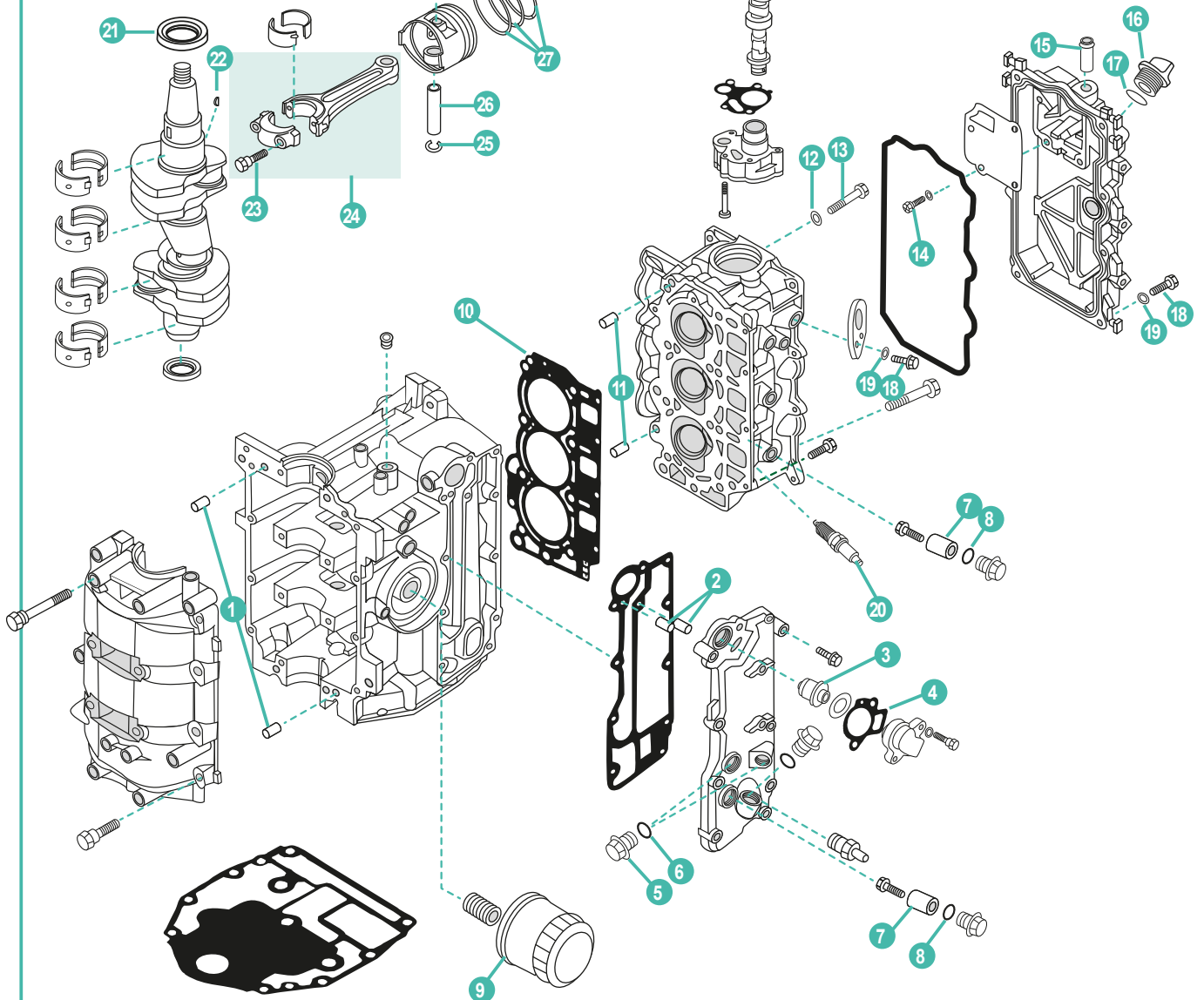
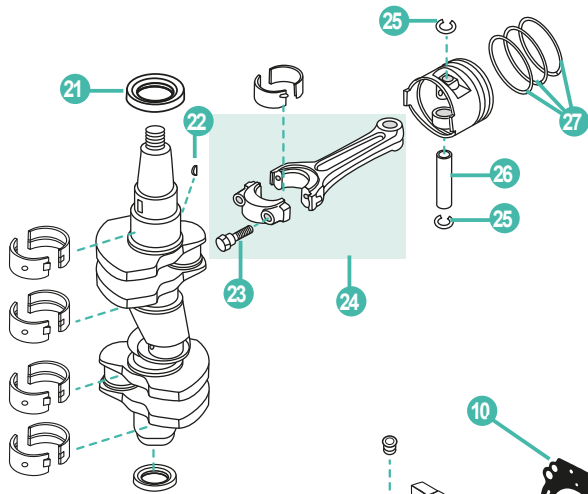
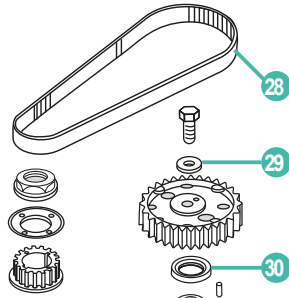
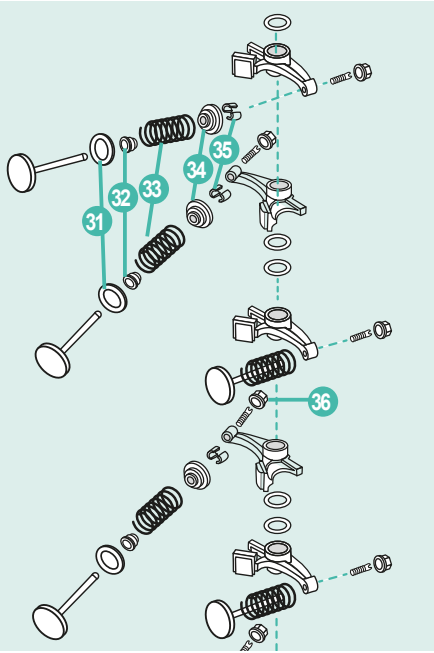

	REF	OEM					UN.
1	REC93606-12019	93606-12019	PIN CENTRADOR	HOLLOW PIN	SPINOTTO DI CENTRAGGIO	PIN DE CENTRAGE	4
2	PAF15-00000013	93604-10M03	PIN CENTRADOR	HOLLOW PIN	SPINOTTO DI CENTRAGGIO	PIN DE CENTRAGE	2
3	PAF15-07000031	6G8-12411-03	TERMOSTATO	THERMOSTAT	TERMOSTATO	THERMOSTAT	1
4	PAF15-07010022	62Y-12414-00	JUNTA TAPA TERMOSTATO	GASKET, THERMOSTAT COVER	GUARNIZIONE COPERCHIO TERMOSTATO	JOINT COUVERCLE DE THERMOSTAT	1
5	PAF15-04000002	90340-14M06	TORNILLO DRENAJE	BOLT, DISCHARGING OIL	VITE DRENAGGIO	VIS DE VIDANGE	2
6	PAF15-04000003	90430-14115	TÓRICA	O-RING	O-RING	JOINT TORIQUE	2
7	CM6G8-11325-00A	6G8-11325-00	ÁNODO	ANODE	ANODO	ANODE	2
8	PAGB/T3452.1-13X2	93210-13M63	TÓRICA	O-RING	O-RING	JOINT TORIQUE	5
9	REC5GH-13440-60	5GH-13440-50	FILTRO ACEITE	OIL FILTER	FILTRO DELL'OLIO	FILTRE À HUILE	1
10	REC6BG-11181-00	6BG-11181-00	JUNTA CULATA	GASKET, CYLINDER HEAD	GUARNIZIONE TESTATA	JOINT DE CULASSE	1
11	PAF25-00000014	99530-08012	PIN CENTRADOR	HOLLOW PIN	SPINOTTO DI CENTRAGGIO	PIN DE CENTRAGE	2
12	PAF25-05050007	90430-06014	JUNTA	GASKET	GUARNIZIONE	JOINT	1
13	PAF25-05050006	90109-06M65	PERNO	STUD	BULLONE	BOULON	1
14	PAGB/T818-M4X10	98507-04010	TORNILLO	SCREW	VITE	VIS	4
15	PAF40-05070002	62Y-14485-00	PIPA DE AGUA	PIPE, WATER	TUBO	RACCORD TUYAU D'EAU	1
16	PAF15-07050004	6G8-15363-00	TAPÓN ACEITE	PLUG, OIL	TAPPO OLIO	BOUCHON DE REMPLISSAGE D'HUILE	1
17	PAF4-04000008	93210-24M79	TÓRICA	O-RING	O-RING	JOINT TORIQUE	1
18	PAGB/T5783-M6X20	97095-06020	PERNO	STUD	BULLONE	BOULON	9
19	PAGB/T97.1-6	92995-06600	ARANDELA	WASHER	RONDELLA	RONDELLE	9
20	NGKDPR6EB-9	94702-00418	BUJÍA	SPARK PLUG	CANDELA	BOUGIE	3
21	PAF25-05020003	93102-43M42	RETÉN DE ACEITE	OIL SEAL	PARAOLIO	JOINT D'HUILE	1
22	PAGB/T1099-3X5X13	90280-03017	CUÑA	KEY WOODRUFF	CHIAVETTA	CLAVETTE	1
23	PAF25-05020204	6C5-11654-00	TORNILLO	SCREW	VITE	VIS	2
24	PAF25-05020200	6C5-11650-10	BIELA COMPLETA	ROD, CONNECTING ASSY	BIELLA COMPLETA	BIELLE COMPLÈTE	3
25	PAF25-05020106	93450-17129	CIRCLIP	CIRCLIP	CIRCLIP	CIRCLIP	6
26	PAF25-05020105	62Y-11633-00	PIN, PISTÓN	PIN, PISTON	SPINOTTO PISTONE	AXE DE PISTON	3
27	REC67C-11603-00	67C-11603-00	KIT SEGMENTOS DE PISTÓN	PISTON RING KIT	KIT FASCIA PISTONE	KIT DE SEGMENTS	3
28	REC6C5-46241-00	6C5-46241-00	CORREA	BELT	CINGHIA	COURROIE DISTRIBUTION	1
29	PAF25-05050018	90201-10144	ARANDELA	WASHER	RONDELLA	RONDELLE	1
30	PAF25-05050021	93102-37M40	RETÉN DE ACEITE	OIL SEAL	PARAOLIO	JOINT D'HUILE	1
31	PAF25-05050003	62Y-12116-00	ARANDELA ASIENTO	SEAT, VALVE SPRING	RONDELLA BASAMENTO	SIEGE RESSORT DE SOUPAPE	6
32	PA166F-010003	51Y-12119-00	RETÉN DE ACEITE	OIL SEAL	PARAOLIO	JOINT D'HUILE	6
33	PAF25-05050005	51Y-12114-00	MUELLE DE VÁLVULA	SPRING, VALVE STEM	MOLLA DI VALVOLA	RESSORT DE SOUPAPE	6
34	PAF15-07040006	30X-12117-00	RETÉN RESORTE	SPRING, VALVE RETAINER	VALVOLA DI RITEGNO	JOINT DE RESSORT	6
35	PAF15-07040007	30X-12118-00	SEGURO DE VÁLVULA	CLAMP, VALVE	BLOCCAGGIO DI VALVOLA	CLAVETTE DE SOUPAPE	12
36	PAF15-07040304	62Y-12158-00	TUERCA	LOCK NUT	DADO	ÉCROU	1





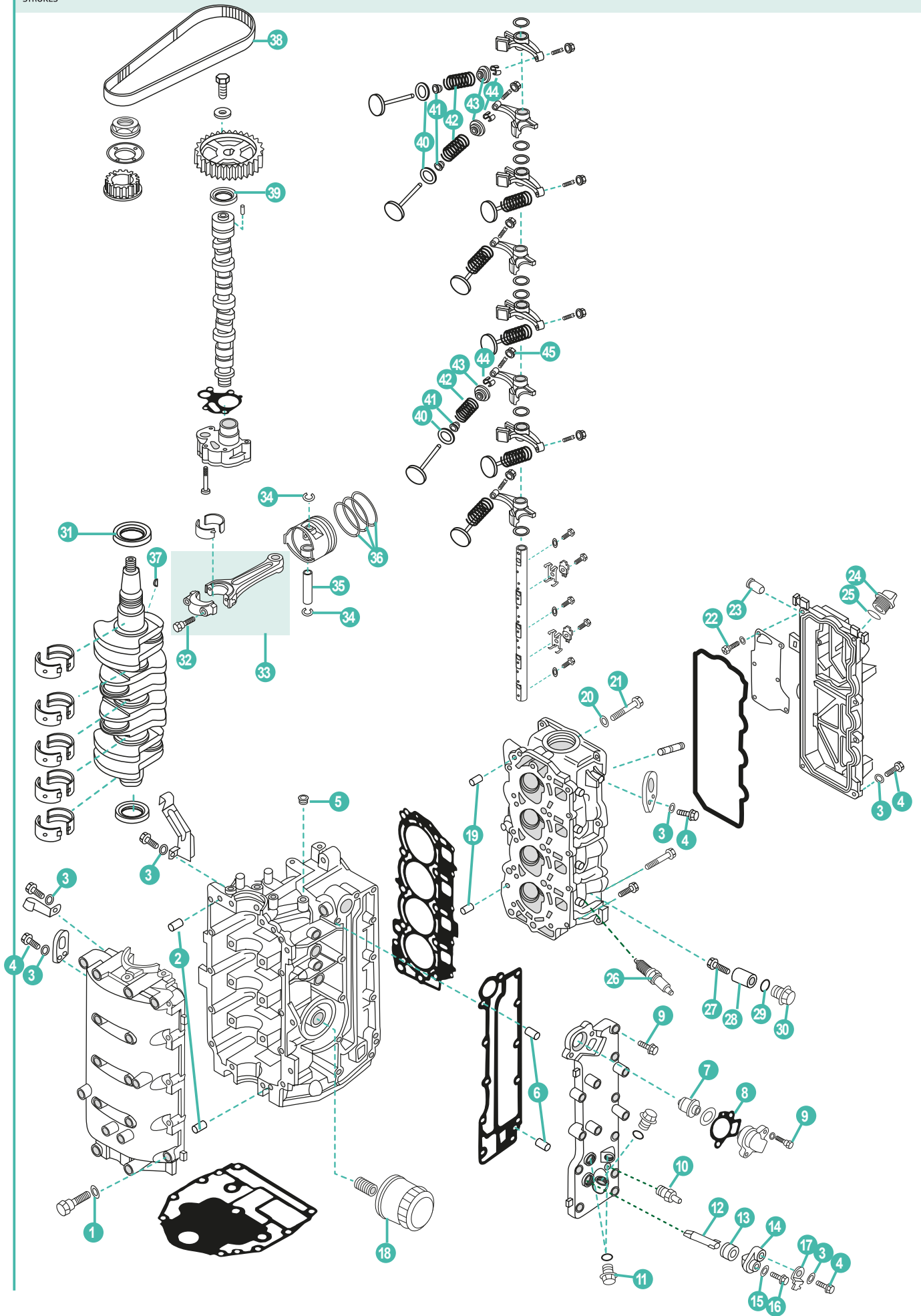

	REF	OEM				UN.	
1	PAGB/T848-6	92903-06600	ARANDELA	WASHER	RONDELLA	RONDELLE	10
2	REC93606-12019	93606-12019	PIN CENTRADOR	HOLLOW PIN	SPINOTTO DI CENTRAGGIO	PIN DE CENTRAGE	4
3	PAGB/T97.1-6	92995-06600	ARANDELA	WASHER	RONDELLA	RONDELLE	14
4	PAGB/T5783-M6X20	97095-06020	PERNO	STUD	BULLONE	BOULON	12
5	PAF15-07010004	90344-51003	TAPÓN	CAP	TAPPO	BOUCHON	1
6	PAF25-04000007	93604-10M03	PIN CENTRADOR	HOLLOW PIN	SPINOTTO DI CENTRAGGIO	PIN DE CENTRAGE	2
7	PAF15-07000031	6G8-12411-03	TERMOSTATO	THERMOSTAT	TERMOSTATO	THERMOSTAT	1
8	REC6H3-12414-A1	62Y-12414-00	JUNTA TAPA TERMOSTATO	GASKET, THERMOSTAT COVER	GUARNIZIONE COPERCHIO TERMOSTATO	JOINT COUVERCLE DE THERMOSTAT	1
9	PAGB/T5782-M6X35	90119-06MA5	TORNILLO	SCREW	VITE	VIS	12
10	PAF25-05010113	62Y-12481-10	NIPLE DE MANGUERA	NIPPLE	TUBO	RACCORD D'EAU	1
11	PAF15-04000002	90340-14M06	TORNILLO DRENAJE	BOLT, DISCHARGING OIL	VITE DRENAGGIO	VIS DE VIDANGE	2
12	CM62Y-11325-00A	62Y-11325-00	ÁNODO	ANODE	ANODO	ANODE	1
13	PAF15-07010009	66M-11328-00	TAPÓN	CAP	TAPPO	BOUCHON	1
14	PAF15-07010011	66M-11327-00-94	TAPA ÁNODO	COVER, ANODE	COPERTURA ANODO	COUVERCLE DU ANODE	1
15	PAGB/T97.1-8	92995-05600	ARANDELA	WASHER	RONDELLA	RONDELLE	1
16	PAGB/T818-M5X12	97095-05012	PERNO	STUD	BULLONE	BOULON	1
17	PAF15-07010012	66M-12535-00	EMPAQUETADURA DE ÁNODO	PLATE, ANODE	PIASTRA ANODO	PLAQUE D'ANODE	14
18	REC5GH-13440-60	5GH-13440-20	FILTRO ACEITE	OIL FILTER	FILTRO DELL'OLIO	FILTRE À HUILE	1
19	PAF25-00000014	99530-08012	PIN CENTRADOR	HOLLOW PIN	SPINOTTO DI CENTRAGGIO	PIN DE CENTRAGE	2
20	PAF25-05050007	90430-06014	JUNTA	GASKET	GUARNIZIONE	JOINT	1
21	PAF25-05050006	90109-06M65	PERNO	STUD	BULLONE	BOULON	1
22	PAGB/T818-M4X10	98507-04010	TORNILLO	SCREW	VITE	VIS	6
23	PAF40-05070002	62Y-14485-00	PIPA DE AGUA	PIPE, WATER	TUBO	RACCORD TUYAU D'EAU	1
24	PAF15-07050004	6G8-15363-00	RETÉN DE ACEITE	OIL SEAL	PARAOLIO	JOINT D'HUILE	1
25	PAF4-04000008	93210-24M79	TÓRICA	O-RING	O-RING	JOINT TORIQUE	1
26	NGK DPR6EB-9	94702-00418	BUJÍA	PLUG SPARK	CANDELA	BOUGIE	4
27	PAGB/T818-M5X25	97880-05025	TORNILLO	SCREW	VITE	VIS	4
28	CM6G8-11325-00A	6G8-11325-00	ÁNODO	ANODE	ANODO	ANODE	4
29	PAGB/T3452.1-13X2	93210-13M63	TÓRICA	O-RING	O-RING	JOINT TORIQUE	4
30	PAF20-05030009	6G8-11197-01	TAPÓN	CAP	TAPPO	BOUCHON	4
31	PAF25-05020003	93102-43M42	RETÉN DE ACEITE	OIL SEAL	PARAOLIO	JOINT SPI	1
32	PAF25-05020204	6C5-11654-00	TORNILLO	SCREW	VITE	VIS	2
33	PAF25-05020200	6C5-11650-00	BIELA COMPLETA	ROD, CONNECTING ASSY	BIELLA COMPLETA	BIELLE COMPLÈTE	4
34	PAF25-05020106	93450-17129	CIRCLIP	CIRCLIP	CIRCLIP	CIRCLIP	8
35	PAF25-05020105	62Y-11633-00	PIN, PISTÓN	PIN, PISTON	SPINOTTO PISTONE	AXE DE PISTON	4
36	REC67C-11603-00	67C-11603-00	KIT SEGMENTOS DE PISTÓN	PISTON RING KIT	KIT FASCIA PISTONE	KIT DE SEGMENTS	4
37	PAGB/T1099-3X5X13	90280-03M01	CHAVETA	KEY WOODRUFF	CHIAVETTA	CLAVETTE	1
38	REC6C5-46241-00	6C5-46241-00	CORREA DISTRIBUCIÓN	BELT, TIMING	CINGHIA DISTRIBUZIONE	COURROIE DISTRIBUTION	1
39	PAF25-05050021	93102-37M40	RETÉN DE ACEITE	OIL SEAL	PARAOLIO	JOINT SPI	1
40	PAF25-05050003	62Y-12116-00	ARANDELA ASIENTO	SEAT, VALVE SPRING	RONDELLA BASAMENTO	SIEGE RESSORT DE SOUPAPE	8
41	PAPS2700.04.03	51Y-12119-00	RETÉN DE ACEITE	OIL SEAL	PARAOLIO	JOINT SPI	8
42	PAF25-05050005	51Y-12114-00	MUELLE DE VÁLVULA	SPRING, VALVE STEM	MOLLA DI VALVOLA	RESSORT DE SOUPAPE	8
43	PAF15-07040006	30X-12117-00	RETÉN RESORTE	SPRING, VALVE RETAINER	VALVOLA DI RITEGNO	JOINT DE RESSORT	8
44	PAF15-07040007	30X-12118-00	SEGURO DE VÁLVULA	CLAMP, VALVE	BLOCCAGGIO DI VALVOLA	CLAVETTE DE SOUPAPE	16
45	PAF15-07040304	62Y-12158-00	TUERCA	LOCK NUT	DADO	ÉCROU	1



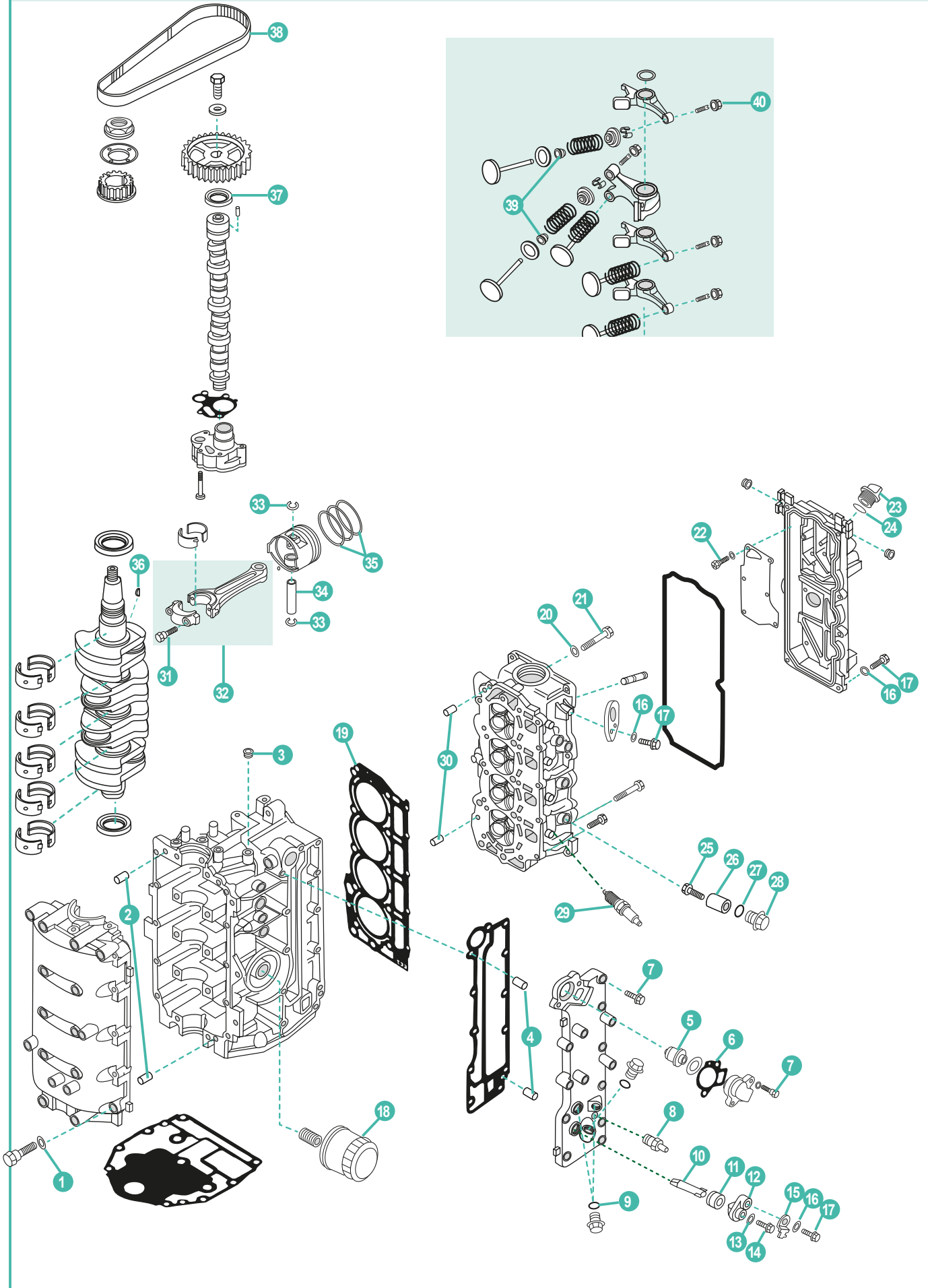

	REF	OEM					UN.
1	PAGB/T848-6	92903-06600	ARANDELA	WASHER	RONDELLA	RONDELLE	10
2	REC93606-12019	90606-12019	PIN CENTRADOR	HOLLOW PIN	SPINOTTO DI CENTRAGGIO	PIN DE CENTRAGE	4
3	PAF15-07010004	90344-51003	TAPÓN	CAP	TAPPO	BOUCHON	1
4	PAF25-04000007	93604-10M03	PIN CENTRADOR	HOLLOW PIN	SPINOTTO DI CENTRAGGIO	PIN DE CENTRAGE	2
5	PAF15-07000031	6G8-12411-03	TERMOSTATO	THERMOSTAT	TERMOSTATO	THERMOSTAT	1
6	REC6H3-12414-A1	62Y-12414-00	JUNTA TAPA TERMOSTATO	GASKET, THERMOSTAT COVER	GUARNIZIONE COPERCHIO TERMOSTATO	JOINT COUVERCLE DE THERMOSTAT	1
7	PAGB/T5782-M6X35	90119-06MA5	ARANDELA	WASHER	RONDELLA	RONDELLE	12
8	PAF25-05010113	62Y-12481-10	NIPLE DE MANGUERA	NIPPLE	TUBO	RACCORD D'EAU	1
9	PAF15-04000002	90340-14M06	TORNILLO DRENAJE	BOLT, DISCHARGING OIL	VITE DRENAGGIO	VIS DE VIDANGE	2
10	CM62Y-11325-00A	62Y-11325-00	ÁNODO	ANODE	ANODO	ANODE	1
11	PAF15-07010009	66M-11328-00	TAPÓN	CAP	TAPPO	BOUCHON	1
12	PAF15-07010011	66M-11327-00-94	TAPA ÁNODO	COVER, ANODE	COPERTURA ANODO	COUVERCLE DU ANODE	1
13	PAGB/T97.1-8	92995-05600	ARANDELA	WASHER	RONDELLA	RONDELLE	1
14	PAGB/T818-M5X12	97095-05012	PERNO	STUD	BULLONE	BOULON	1
15	PAF15-07010012	66M-12535-00	EMPAQUETADURA DE ÁNODO	PLATE, ANODE	PIASTRA ANODO	PLAQUE D'ANODE	1
16	PAGB/T97.1-6	92995-06600	ARANDELA	WASHER	RONDELLA	RONDELLE	1
17	PAGB/T5783-M6X20	97095-06020	PERNO	STUD	BULLONE	BOULON	3
18	REC5GH-13440-60	5GH-13440-50	FILTRO ACEITE	OIL FILTER	FILTRO DELL'OLIO	FILTRE À HUILE	1
19	REC6CJ-11181-00	6CJ-11181-00	JUNTA CULATA	GASKET, CYLINDER HEAD	GUARNIZIONE TESTATA	JOINT DE CULASSE	1
20	PAF25-05050007	90430-06014	JUNTA	GASKET	GUARNIZIONE	JOINT	1
21	PAF25-05050006	90109-06M65	PERNO	STUD	BULLONE	BOULON	1
22	PAGB/T818-M4X10	98507-04010	TORNILLO	SCREW	VITE	VIS	6
23	PAF15-07050004	6G8-15363-00	TAPÓN ACEITE	PLUG, OIL	TAPPO OLIO	BOUCHON REMPLISSAGE D'HUILE	1
24	PAF4-04000008	93210-24M79	TÓRICA	O-RING	O-RING	JOINT TORIQUE	1
25	PAGB/T818-M5X25	97880-05025	TORNILLO	SCREW	VITE	VIS	3
26	CM6G8-11325-00A	6G8-11325-00	ÁNODO	ANODE	ANODO	ANODE	3
27	PAGB/T3452.1-13X2	93210-13M63	TÓRICA	O-RING	O-RING	JOINT TORIQUE	3
28	PAF20-05030009	6G8-11197-01	TAPÓN	CAP	TAPPO	BOUCHON	3
29	NGKLR7E	94702-00429	BUJÍA	SPARK PLUG	CANDELA	BOUGIE	4
30	PAF25-00000014	99530-08012	PIN CENTRADOR	HOLLOW PIN	SPINOTTO DI CENTRAGGIO	PIN DE CENTRAGE	2
31	PAF25-05020204	6C5-11654-00	TORNILLO	SCREW	VITE	VIS	2
32	PAF25-05020200	6C5-11650-10	BIELA COMPLETA	ROD, CONNECTING ASSY	BIELLA COMPLETA	BIELLE COMPLÈTE	4
33	PAF25-05020106	93450-17129	CIRCLIP	CIRCLIP	CIRCLIP	CIRCLIP	8
34	PAF25-05020105	62Y-11633-00	PIN, PISTÓN	PIN, PISTON	SPINOTTO PISTONE	AXE DE PISTON	4
35	REC67C-11603-00	67C-11603-00	KIT SEGMENTOS DE PISTÓN	PISTON RING KIT	KIT FASCIA PISTONE	KIT DE SEGMENTS	4
36	PAGB/T1099-3X5X13	90280-03M01	CHAVETA	KEY WOODRUFF	CHIAVETTA	CLAVETTE	1
37	PAF25-05050021	93102-37M40	RETÉN DE ACEITE	OIL SEAL	PARAOLIO	JOINT SPI	1
38	REC6C5-46241-00	6C5-46241-00	CORREA DISTRIBUCIÓN	BELT, TIMING	CINGHIA DISTRIBUZIONE	COURROIE DISTRIBUTION	1
39	PAPS2700.04.03	51Y-12119-00	RETÉN DE ACEITE	OIL SEAL	PARAOLIO	JOINT SPI	16
40	PAF15-07040304	62Y-12158-00	TUERCA	LOCK NUT	DADO	ÉCROU	8





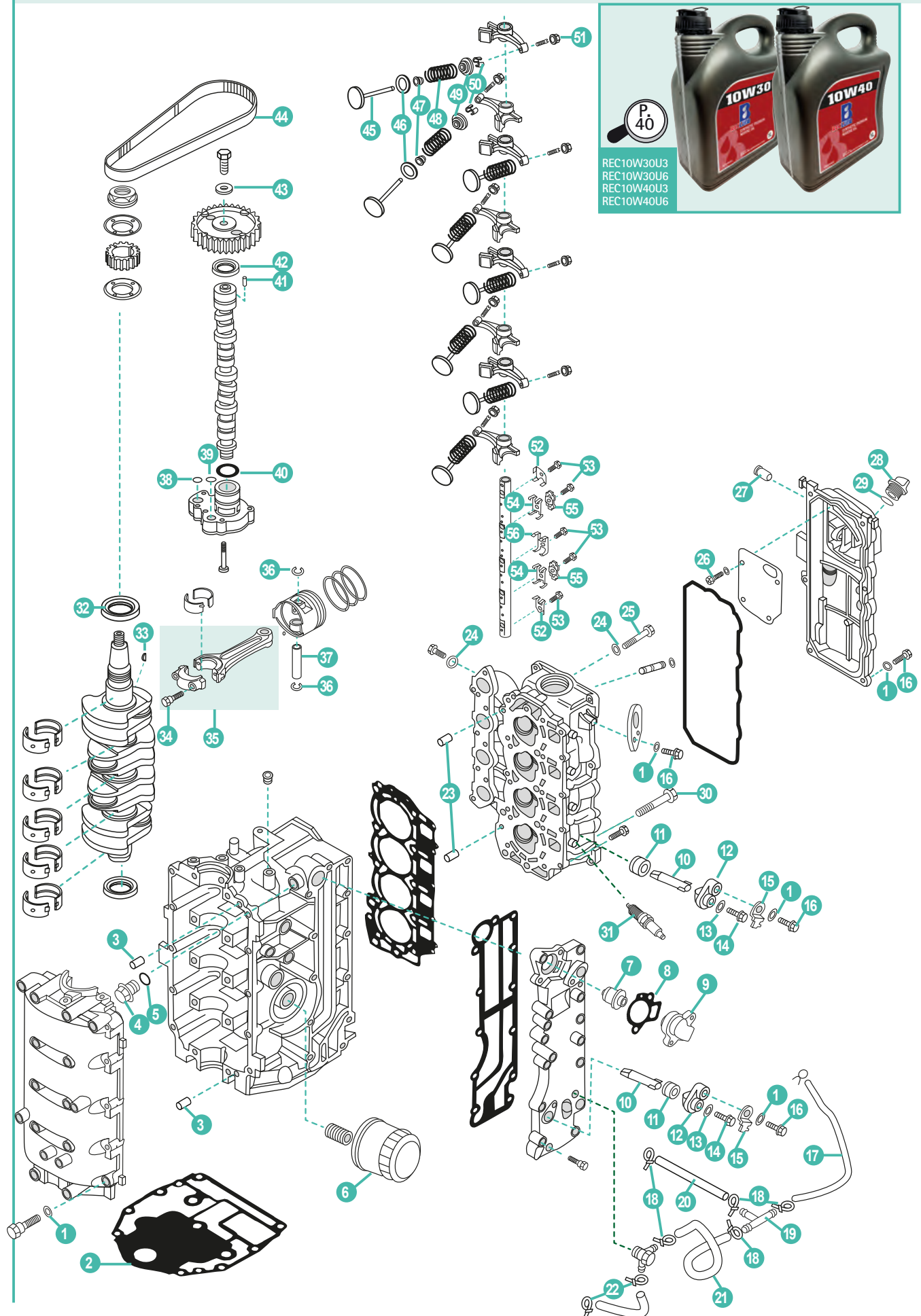

	REF	OEM					UN.
1	PAGB/T97.1-6	92903-06600	ARANDELA	WASHER	RONDELLA	RONDELLE	22
2	REC67C-11351-00	67C-11351-01	JUNTA BASE MOTOR	GASKET ENGINE	GUARNIZIONE BASE MOTORE	JOINT MOTEUR	1
3	REC93606-12019	93606-12019	PIN CENTRADOR	HOLLOW PIN	SPINOTTO DI CENTRAGGIO	PIN DE CENTRAGE	4
4	PAF15-04000002	90340-14M06	TORNILLO DRENAJE	BOLT, DISCHARGING OIL	VITE DRENAGGIO	VIS DE VIDANGE	1
5	PAF15-04000003	90430-14115	TÓRICA	O-RING	O-RING	JOINT TORIQUE	1
6	REC5GH-13440-00	5GH-13440-10	FILTRO ACEITE	OIL FILTER	FILTRO DELL'OLIO	FILTRE À HUILE	1
7	PAF15-07000031	6G8-12411-03	TÓRICA	O-RING	O-RING	JOINT TORIQUE	1
8	REC6H3-12414-A1	62Y-12414-00	JUNTA TAPA TERMOSTATO	GASKET, THERMOSTAT COVER	GUARNIZIONE COPERCHIO TERMOSTATO	JOINT COUVERCLE DE THERMOSTAT	1
9	PAF15-07010021	6H3-12413-00-1S	TAPA TERMOSTATO	COVER, THERMOSTAT	COPERCHIO TERMOSTATO	COUVERCLE DE THERMOSTAT	1
10	CM62Y-11325-00A	62Y-11325-00	ÁNODO	ANODE	ANODO	ANODE	2
11	PAF15-07010009	66M-11328-00	TAPÓN	CAP	TAPPO	BOUCHON	2
12	PAF15-07010011	66M-11327-00-94	TAPA ÁNODO	COVER, ANODE	COPERTURA ANODO	COUVERCLE DU ANODE	2
13	PAGB/T97.1-5	92995-05600	ARANDELA	WASHER	RONDELLA	RONDELLE	1
14	PAGB/T818-M5X12	97095-05012	PERNO	STUD	BULLONE	BOULON	1
15	PAF15-07010012	66M-12535-00	EMPAQUETADORA DE ÁNODO	PLATE, ANODE	PIASTRA ANODO	PLAQUE D'ANODE	1
16	PAGB/T5783-M6X20	97095-06020	PERNO	STUD	BULLONE	BOULON	12
17	PAF15-05000014	90445-09104	TUBO DE AGUA	WATER TUBE	TUBO DELL'ACQUA	DURITE D'EAU	1
18	PAHT-2.5X60	90465-11M10	BRIDA	CLAMP	FLANGIA	COLLIER	5
19	PAF15-05000011	688-24378-00	CONECTOR DE 3 VÍAS	THREE-WAY PIPE	CONNETTORE T	TE	1
20	PAF25-03000009	90445-09095	TUBO DE AGUA	WATER TUBE	TUBO DELL'ACQUA	DURITE D'EAU	1
21	PAF25-03000008	90445-09068	TUBO DE AGUA	WATER TUBE	TUBO DELL'ACQUA	DURITE D'EAU	1
22	PAHT-2.5X60	90465-11M10	BRIDA	CLAMP	FLANGIA	COLLIER	2
23	PAF25-00000014	99530-08012	PIN CENTRADOR	HOLLOW PIN	SPINOTTO DI CENTRAGGIO	PIN DE CENTRAGE	2
24	PAF25-05050007	90430-06014	JUNTA	GASKET	GUARNIZIONE	JOINT	5
25	PAF25-05050006	90109-06M65	TORNILLO	SCREW	VITE	VIS	1
26	PAGB/T818-M4X10	98507-04010	TORNILLO	SCREW	VITE	VIS	4
27	PAF40-05070002	62Y-14485-00	PIPA DE AGUA	PIPE, WATER	TUBO	RACCORD TUYAU D'EAU	1
28	PAF15-07050004	6G8-15363-00	TAPÓN ACEITE	PLUG, OIL	TAPPO OLIO	BOUCHON REMPLISSAGE D'HUILE	1
29	PAJASOF40431-025	93210-24M79	TÓRICA	O-RING	O-RING	JOINT TORIQUE	1
30	PAF25-05000002	90119-09M00	TORNILLO CON ARANDELA	BOLT, FLANGE	VITE CON RONDELLA	VIS DE BRIDE	10
31	NGKDPR6EA-9	94701-00375	BUJÍA	SPARK PLUG	CANDELA	BOUGIE	4
32	PAF25-05020003	93102-43M42	RETÉN DE ACEITE	OIL SEAL	PARAOLIO	JOINT SPI	1
33	PAF4-04000019	90280-04M06	CUÑA	KEY WOODRUFF	CHIAVETTA	CLAVETTE	1
34	PAF25-05020204	6C5-11654-00	TORNILLO	SCREW	VITE	VIS	2
35	PAF25-05020200	6C5-11650-00	BIELA COMPLETA	ROD, CONNECTING ASSY	BIELLA COMPLETA	BIELLE COMPLÈTE	4
36	PAF25-05020106	93450-17129	CIRCLIP	CIRCLIP	CIRCLIP	CIRCLIP	8
37	PAF25-05020105	62Y-11633-00	PIN, PISTÓN	PIN, PISTON	SPINOTTO PISTONE	AXE DE PISTON	4
38	PAF25-05050014	93210-14515	PISTÓN, CONTRA	PISTON, BALANCE	PISTONE, CONTRO	PISTON D'EQUILIBRAGE	1
39	PAF25-05050013	93210-12MG9	TÓRICA	O-RING	O-RING	JOINT TORIQUE	1
40	PAF25-05050015	93210-33MH2	TÓRICA	O-RING	O-RING	JOINT TORIQUE	1
41	PAF25-05050016	93605-14143	PIN CENTRADOR	HOLLOW PIN	SPINOTTO DI CENTRAGGIO	PIN DE CENTRAGE	1
42	PAF25-05050021	93102-37M40	RETÉN DE ACEITE	OIL SEAL	PARAOLIO	JOINT SPI	1
43	PAF25-05050018	90201-10M06	ARANDELA	WASHER	RONDELLA	RONDELLE	1
44	REC62Y-46241-00	62Y-46241-00	CORREA DISTRIBUCIÓN	BELT, TIMING	CINGHIA DISTRIBUZIONE	COURROIE DISTRIBUTION	1
45	PAF25-05050002	62Y-12121-00	VÁLVULA ESCAPE	VALVE, EXHAUST	VALVOLA SCARICO	SOUPAPE D'ÉCHAPPEMENT	4
46	PAF25-05050003	62Y-12116-00	ARANDELA ASIENTO	SEAT, VALVE SPRING	RONDELLA BASAMENTO	SIEGE RESSORT DE SOUPAPE	8
47	PAPS2700.04.03	51Y-12119-00	RETÉN DE ACEITE	OIL SEAL	PARAOLIO	JOINT SPI	8
48	PAF25-05050005	51Y-12114-00	MUELLE DE VÁLVULA	SPRING, VALVE STEM	MOLLA DI VALVOLA	RESSORT DE SOUPAPE	8
49	PAF15-07040006	30X-12117-00	RETÉN RESORTE	SPRING, VALVE RETAINER	VALVOLA DI RITEGNO	JOINT DE RESSORT	8
50	PAF15-07040007	30X-12118-00	SEGURO DE VÁLVULA	CLAMP, VALVE	BLOCCAGGIO DI VALVOLA	CLAVETTE DE SOUPAPE	16
51	PAF15-07040304	62Y-12158-00	TUERCA	LOCK NUT	DADO	ÉCROU	8
52	PAF25-05050009	62Y-12238-00	PLACA TOPE DE PERNO	PLATE, BOLT STOPPER	PIASTRA DE VITE	PLAQUE DE FIXATION	2
53	PAF25-05050019	90109-08M63	TORNILLO	SCREW	VITE	VIS	5
54	PAF25-05050011	62Y-12216-00	RESORTE	SPRING	MOLLA	RESSORT	14
55	PAF25-05050012	62Y-12231-00	TOPE DE GUÍA	PLATE, BOLT STOPPER	PIASTRA DE GUIDA	PLAQUE DE FIXATION	2
56	PAF40-05040003	62Y-12279-00	PLACA EJE DE BALANCINES	FIXED PLATE B, ROCKER SHAFT	PIASTRA, ASSE BILANCERE	PLAQUE ARBRE DE CULBUTEUR	1

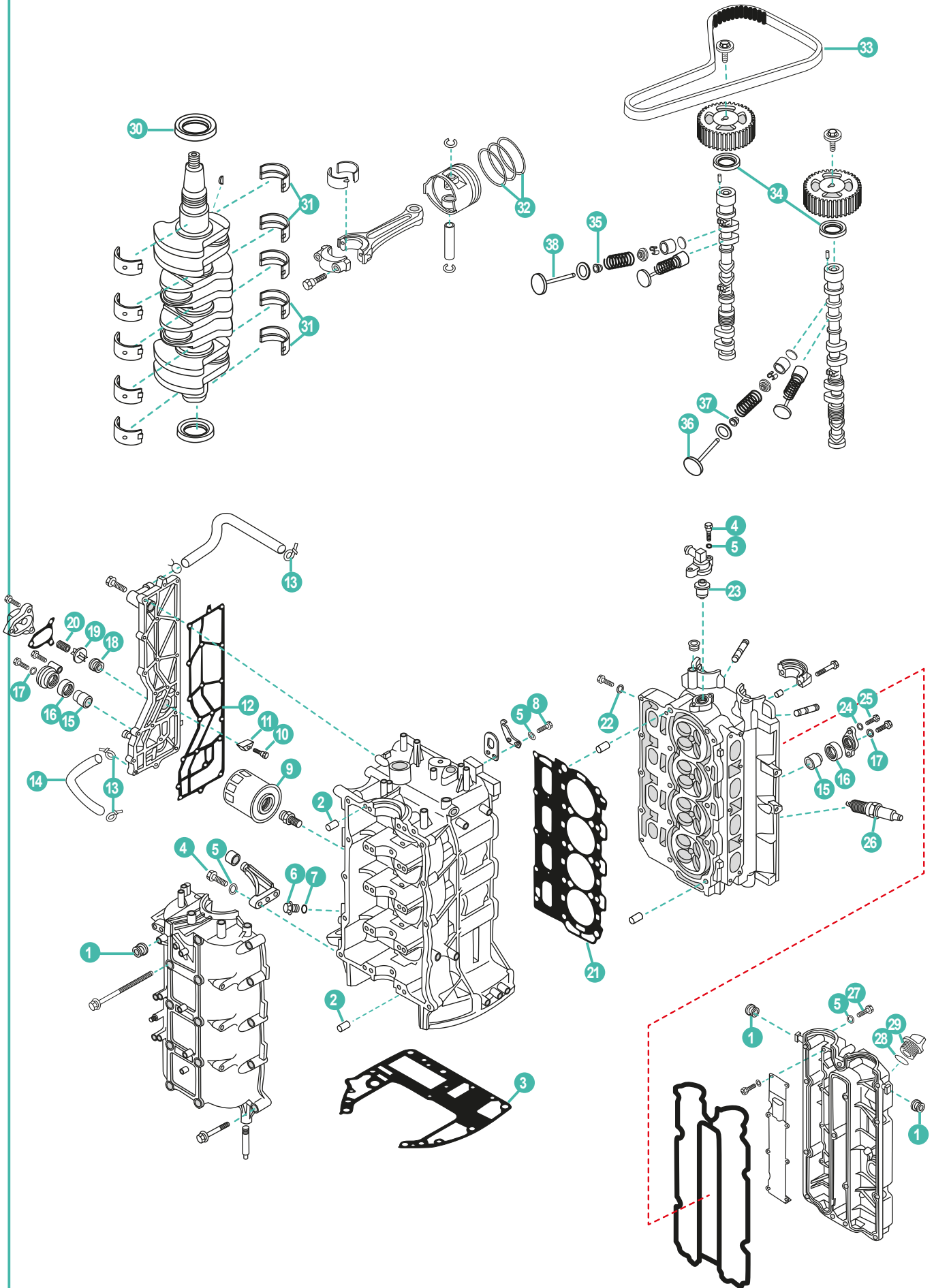

	REF	OEM				UN.	
1	PAF15-07010027	90480-12072	TAPÓN	CAP	TAPPO	BOUCHON	3
2	REC93606-12019	93606-12019	PIN CENTRADOR	HOLLOW PIN	SPINOTTO DI CENTRAGGIO	PIN DE CENTRAGE	24
3	REC68V-11351-00	68V-11351-00	JUNTA BASE MOTOR	GASKET ENGINE	GUARNIZIONE BASE MOTORE	JOINT MOTEUR	1
4	PAGB/T5782-M6X25	97095-06025	TORNILLO	SCREW	VITE	VIS	6
5	PAGB/T97.1-6	92995-06600	ARANDELA	WASHER	RONDELLA	RONDELLE	24
6	PAF15-04000002	90340-14M06	TORNILLO DRENAJE	BOLT, DISCHARGING OIL	VITE DRENAGGIO	VIS DE VIDANGE	1
7	PAF15-04000003	90430-14115	TÓRICA	O-RING	O-RING	JOINT TORIQUE	1
8	PAGB/T5783-M6X20	97095-06020	TORNILLO	SCREW	VITE	VIS	4
9	REC5GH-13440-00	5GH-13440-00	FILTRO ACEITE	OIL FILTER	FILTRO DELL'OLIO	FILTRE À HUILE	1
10	PAGB/T820-M4X12	98780-04016	TORNILLO	SCREW	VITE	VIS	3
11	CM15026A	6E5-11325-00	ÁNODO	ANODE	ANODO	ANODE	3
12	REC67F-41114-A2	6D8-41114-A0	JUNTA	GASKET	GUARNIZIONE	JOINT	1
13	PAHT-2.5X60	90465-11M10	BRIDA	CLAMP	FLANGIA	COLLIER	3
14	PAF40-05000053	90445-10M40	TUBO	TUBE	TUBO	DURITE	1
15	CM68V-11325-01A	68V-11325-02	ÁNODO	ANODE	ANODO	ANODE	2
16	REC67F-11328-00	67F-11328-00	TAPÓN	CAP	TAPPO	BOUCHON	2
17	REC90430-06M03	90430-06M03	JUNTA	GASKET	GUARNIZIONE	JOINT	2
18	REC90480-20M05	90480-20M05	TAPÓN	CAP	TAPPO	BOUCHON	1
19	REC60H-12416-00	6G5-12416-00	VÁLVULA CONTROL DE PRESIÓN	VALVE, PRESSURE CONTROL	VALVOLA ANTIPRESSIONE	SOUPAPE DE DEPRESSION	1
20	REC90501-16M11	90501-16M11	RESORTE	SPRING	MOLLA	RESSORT	1
21	REC67F-11181-03	67F-11181-02	JUNTA CULATA	GASKET, CYLINDER HEAD	GUARNIZIONE TESTATA	JOINT DE CULASSE	1
22	PAF4-04000006	90430-08143	JUNTA	GASKET	GUARNIZIONE	JOINT	4
23	REC67F-12411-01	67F-12411-01	TERMOSTATO	THERMOSTAT	TERMOSTATO	THERMOSTAT	1
24	PAGB/T97.1-8	92995-08600	ARANDELA	WASHER	RONDELLA	RONDELLE	4
25	PAGB/T5783-M8X25	97075-08025	PERNO	STUD	BULLONE	BOULON	4
26	NGKLF5A-11	94702-00391	BUJÍA	SPARK PLUG	CANDELA	BOUGIE	4
27	REC90101-06M56	97095-06030	TORNILLO	SCREW	VITE	VIS	14
28	PAJASOF40431-025	93210-24M79	TÓRICA	O-RING	O-RING	JOINT TORIQUE	1
29	PAF15-07050004	6G8-15363-00	TAPÓN ACEITE	PLUG, OIL	TAPPO OLIO	BOUCHON REMPLISSAGE D'HUILE	1
30	REC93102-48009	93102-48009	RETÉN DE ACEITE	OIL SEAL	PARAOLIO	JOINT SPI	1
31	REC67F-11416-00	67F11416-00	COJINETE PLANO 1 VERDE	MAIN BEARING 1 GREEN	CUSCINETTO 1 VERDE	PALIER 1 VERT	4
	REC67F-11416-10	67F11416-10	COJINETE PLANO 1 AZUL	MAIN BEARING 1 BLUE	CUSCINETTO 1 BLUE	PALIER 1 BLEU	4
	REC67F-11416-20	67F11416-20	COJINETE PLANO 1 ROJO	MAIN BEARING 1 RED	CUSCINETTO 1 ROSSO	PALIER 1 ROUGE	4
32	REC6D8-11603-10	6D8-11603-01	KIT SEGMENTOS DE PISTÓN 200-300	PISTON RING KIT 200-300	KIT FASCIA PISTONE 200-300	KIT DE SEGMENTS 200-300	4
	REC6D8-11604-10	6D8-11604-01	KIT SEGMENTOS DE PISTÓN 0.25mm O/S	PISTON RING KIT 0.25mm O/S	KIT FASCIA PISTONE 0.25mm O/S	KIT DE SEGMENTS 0.25 mm O/S	4
33	REC67F-46241-00	67F-46241-00	CORREA	BELT	CINGHIA	COURROIE DISTRIBUTION	1
34	REC93102-38008	93102-38M59	RETÉN DE ACEITE	OIL SEAL	PARAOLIO	JOINT SPI	2
35	RECK0A-A3722-00	K0A-A3722-00	RETÉN DE ACEITE	OIL SEAL	PARAOLIO	JOINT SPI	8
36	REC68V-12111-00	68V-12111-00	VÁLVULA ADMISIÓN	VALVE, INTAKE	VALVOLA ASPIRAZIONE	SOUPAPE D ADMISSION	8
37	RECK0A-A3721-00	K0A-A3721-00	RETÉN DE ACEITE	OIL SEAL	PARAOLIO	JOINT SPI	8

**4T** F80B/C, F100/B/D, F115A  
STROKES

	REF	OEM				UN.	
36	REC6D8-12111-00	6D8-12111-00	VÁLVULA DE ADMISIÓN Ø96,75mm	VALVE, INTAKE Ø96,75mm	VALVOLA ASPIRAZIONE Ø96,75mm	SOUPAPE D ADMISSION Ø96,75mm	8
38	REC6D8-12121-10	6D8-12121-10	VÁLVULA DE ESCAPE Ø98,95 mm	VALVE, EXHAUST Ø98,95 mm	VALVOLA SCARICO Ø98,95 mm	SOUPAPE D'ECHAPPEMENT Ø98,95 mm	8

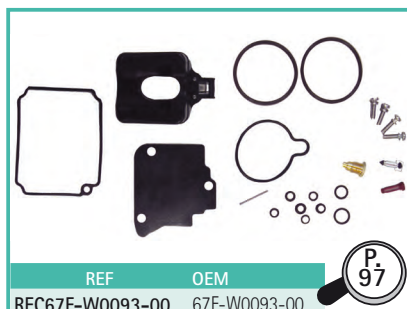
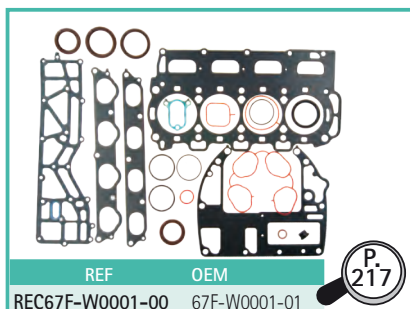



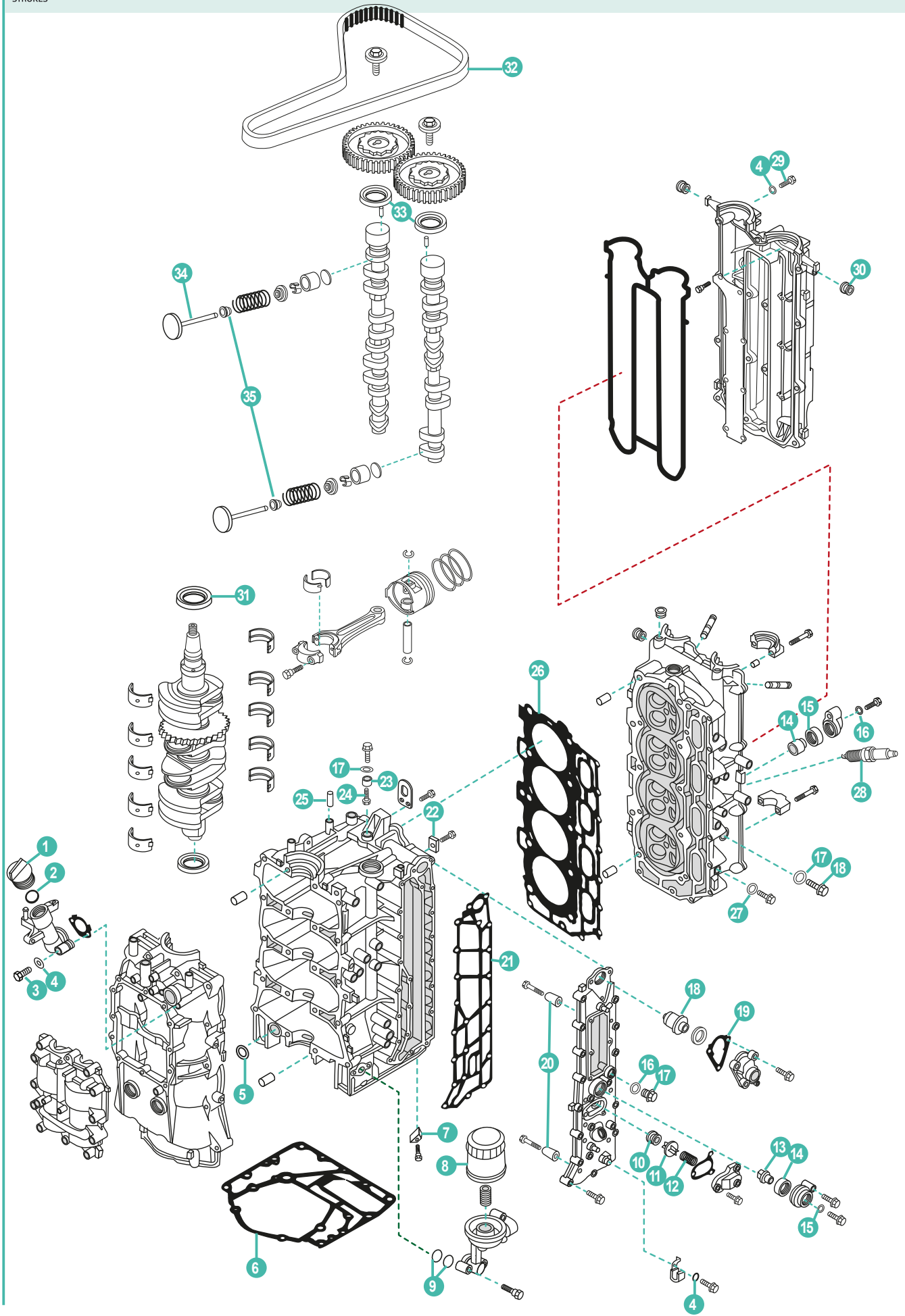

	REF	OEM					UN.
1	PAF15-07050004	6G8-15363-00	TAPÓN ACEITE	PLUG, OIL	TAPPO OLIO	BOUCHON REMPLISSAGE D'HUILE	1
2	PAJASOF40431-025	93210-24M79	TÓRICA	O-RING	O-RING	JOINT TORIQUE	1
3	REC97095-06045	97095-06045	TORNILLO	SCREW	VITE	VIS	2
4	PAGB/T97.1-6	92995-06600	ARNADELA	WASHER	RONDELLA	RONDELLE	15
5	REC93210-25552	93210-25552	TÓRICA	O-RING	O-RING	JOINT TORIQUE	1
6	REC63P-11351-01	63P-11351-00	JUNTA BASE MOTOR	GASKET ENGINE	GUARNIZIONE BASE MOTORE	JOINT MOTEUR	1
7	CM63P-11325-01A	63P-11325-01	ÁNODO	ANODE	ANODO	ANODE	1
8	REC35-822626Q15	69J-13440-01	FILTRO ACEITE	OIL FILTER	FILTRO DELL'OLIO	FILTRE À HUILE	1
9	REC93210-19MJ1	93210-19MJ1	TÓRICA	O-RING	O-RING	JOINT TORIQUE	2
10	REC90480-20M05	90480-20M05	TAPÓN	CAP	TAPPO	BOUCHON	1
11	REC60H-12416-00	6G5-12416-00	VÁLVULA DE PRESIÓN	VALVE, PRESSURE CONTROL	VALVOLA ANTIPRESSIONE	SOUPAPE DE DEPRESSION	1
12	REC90501-16M11	90501-16M11	RESORTE	SPRING	MOLLA	RESSORT	1
13	CM67F-11325-01A	67F-11325-01	ÁNODO	ANODE	ANODO	ANODE	2
14	REC67F-11328-00	67F-11328-00	TAPÓN	CAP	TAPPO	BOUCHON	2
15	REC90430-06M03	90430-06M03	JUNTA	GASKET	GUARNIZIONE	JOINT	2
16	PAF15-04000003	90430-14115	JUNTA	GASKET	GUARNIZIONE	JOINT	1
17	PAF15-04000002	90340-14M06	TORNILLO DRENAJE	BOLT, DISCHARGING OIL	VITE DRENAGGIO	VIS DE VIDANGE	1
18	REC67F-12411-01	67F-12411-01	TERMOSTATO	THERMOSTAT	TERMOSTATO	THERMOSTAT	1
19	REC63P-12414-00	63P-12414-00	JUNTA TAPA TERMOSTATO	GASKET, THERMOSTAT COVER	GUARNIZIONE COPERCHIO TERMOSTATO	JOINT COUVERCLE DE THERMOSTAT	1
20	CM68T-11325-00A	68T-11325-00	ÁNODO	ANODE	ANODO	ANODE	8
21	REC63P-41114-A3	63P-41114-A1	JUNTA	GASKET	GUARNIZIONE	JOINT	1
22	CM63P-11325-11A	63P-11325-11	ÁNODO	ANODE	ANODO	ANODE	4
23	TEN01165	63P-11325-21	ÁNODO	ANODE	ANODO	ANODE	1
24	PAGB/T818-M5X16	98780-05016	TORNILLO	SCREW	VITE	VIS	1
25	REC93606-12019	93606-12019	PIN CENTRADOR	HOLLOW PIN	SPINOTTO DI CENTRAGGIO	PIN DE CENTRAGE	1
26	REC63P-11181-00	63P-11181-00	JUNTA CULATA	GASKET, CYLINDER HEAD	GUARNIZIONE TESTATA	JOINT DE CULASSE	1
27	PAF4-04000006	90430-08143	JUNTA	GASKET	GUARNIZIONE	JOINT	4
28	NGKFR5A-11	94702-00391	BUJÍA	SPARK PLUG	CANDELA	BOUGIE	4
29	PAGB/T5783-M6X30	97095-06030	TORNILLO	SCREW	VITE	VIS	13
30	PAF15-07010027	90480-12072	TAPÓN	CAP	TAPPO	BOUCHON	5
31	REC93102-60004	93102-60004	RETÉN DE ACEITE	OIL SEAL	PARAOLIO	JOINT SPI	1
32	REC63P-46241-00	63P-46241-00	CORREA DISTRIBUCIÓN	BELT, TIMING	CINGHIA DISTRIBUZIONE	COURROIE DISTRIBUTION	1
33	REC93102-38008	93102-38008	RETÉN DE ACEITE	OIL SEAL	PARAOLIO	JOINT SPI	2
34	REC69J-12111-00	69J-12111-00	VÁLVULA ADMISIÓN Ø92.5 mm	VALVE, INTAKE Ø92.5 mm	VALVOLA ASPIRAZIONE Ø92.5 mm	SOUPAPE D ADMISSION Ø92.5 mm	8
35	REC69J-12119-00	69J-12119-00	RETÉN DE ACEITE	OIL SEAL	PARAOLIO	JOINT SPI	16



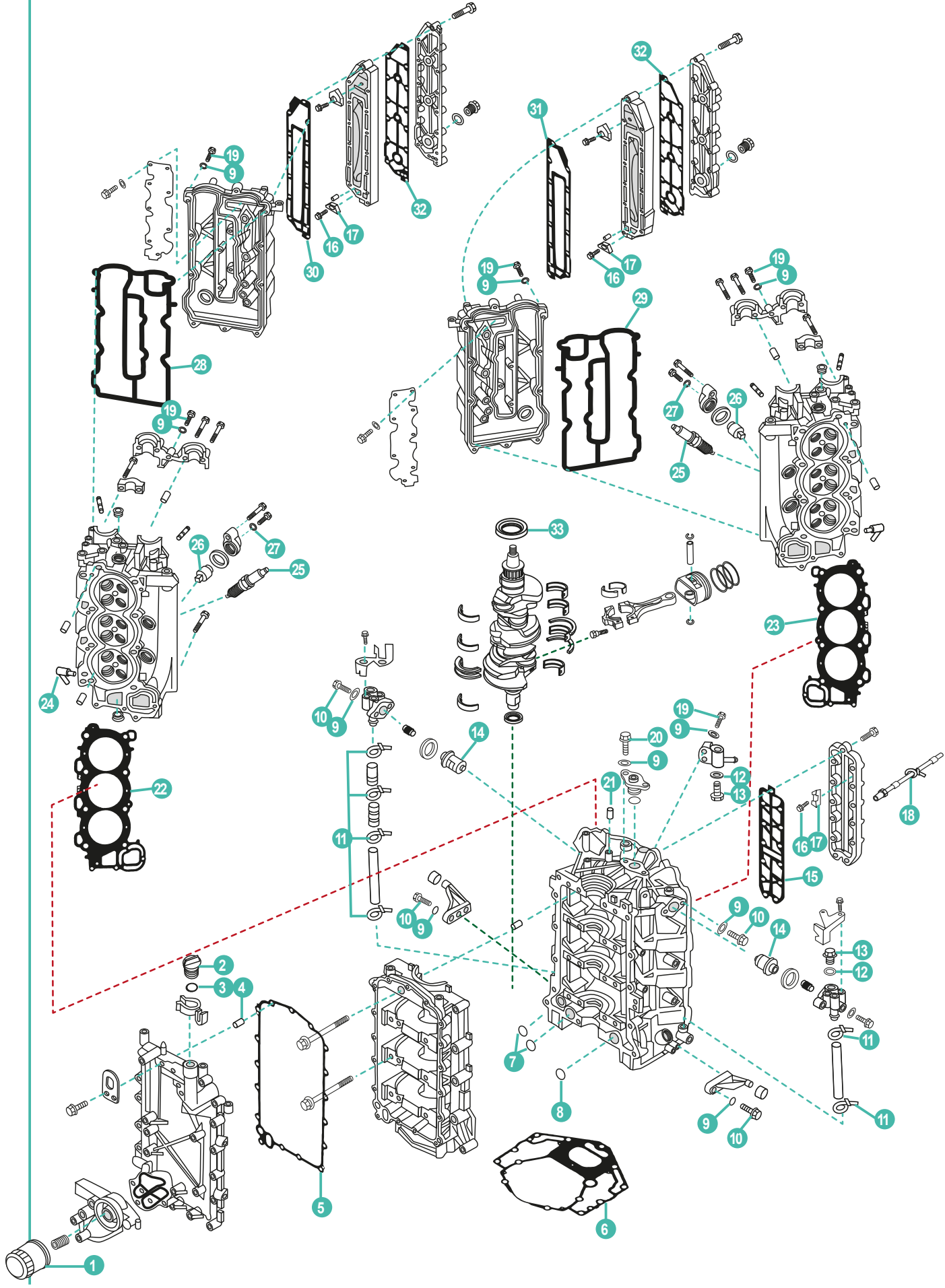

	REF	OEM					UN.
1	REC35-822626Q15	69J-13440-01	FILTRO ACEITE	OIL FILTER	FILTRO DELL'OLIO	FILTRE À HUILE	1
2	PAF15-07050004	6G8-15363-00	TAPÓN ACEITE	PLUG, OIL	TAPPO OLIO	BOUCHON REMPLISSAGE D'HUILE	1
3	PAJASOF40431-025	93210-24M79	TÓRICA	O-RING	O-RING	JOINT TORIQUE	1
4	REC93606-12019	93606-12019	PIN CENTRADOR	HOLLOW PIN	SPINOTTO DI CENTRAGGIO	PIN DE CENTRAGE	2
5	REC69J-15451-00	69J-15451-00	JUNTA	GASKET	GUANIZIONE	JOINT	1
6	REC69J-11351-11	69J-11351-11	JUNTA BASE MOTOR	GASKET ENGINE	GUARNIZIONE BASE MOTORE	JOINT MOTEUR	1
7	REC93210-19MJ1	93210-19MJ1	TÓRICA	O-RING	O-RING	JOINT TORIQUE	2
8	REC93210-25552	93210-25552	TÓRICA	O-RING	O-RING	JOINT TORIQUE	1
9	PAGB/T97.1-6	92995-06600	ARANDELA	WASHER	RONDELLA	RONDELLE	28
10	PAGB/T5782-M6X25	97095-06025	TORNILLO	SCREW	VITE	VIS	8
11	REC09401-11425	90465-11M59	BRIDA	CLAMP	FLANGIA	COLLIER	6
12	PAF15-04000003	90430-14115	JUNTA	GASKET	GUARNIZIONE	JOINT	2
13	PAF15-04000002	90340-14M06	TORNILLO DRENAJE	BOLT, DISCHARGING OIL	VITE DRENAGGIO	VIS DE VIDANGE	2
14	REC67F-12411-01	67F-12411-01	TERMOSTATO	THERMOSTAT	TERMOSTATO	THERMOSTAT	2
15	REC6P2-1131B-00	6P2-1131B-00	JUNTA (NO SERIE A)	GASKET (NO SERIAL A)	GUARNIZIONE (NO SERIE A)	JOINT (NO SÉRIE A)	1
16	PAGB/T820-M4X12	98780-04015	TORNILLO	SCREW	VITE	VIS	6
17	CM15026A	6E5-11325-00	ÁNODO	ANODE	ANODO	ANODE	6
18	PAHT-2.5X60	90465-11M10	BRIDA	CLAMP	FLANGIA	COLLIER	1
19	PAGB/T5783-M6X30	97095-06030	TORNILLO	SCREW	VITE	VIS	18
20	PAGB/T5783-M6X20	97095-06020	TORNILLO	SCREW	VITE	VIS	2
21	REC93606-12019	93606-12019	PIN CENTRADOR	HOLLOW PIN	SPINOTTO DI CENTRAGGIO	PIN DE CENTRAGE	1
22	REC6P2-11181-00	6P2-11181-00	JUNTA CULATA 1	GASKET, CYLINDER HEAD 1	GUARNIZIONE TESTATA 1	JOINT DE CULASSE 1	1
23	REC6P2-11182-00	6P2-11182-00	JUNTA CULATA 2	GASKET, CYLINDER HEAD 2	GUARNIZIONE TESTATA 2	JOINT DE CULASSE 2	1
24	PAF15-04000005	676-11372-00	NIPLE DE MANGUERA	NIPPLE	TUBO	RACCORD D'EAU	1
25	NGKLF6A-11	94702-00400	BUJÍA	SPARK PLUG	CANDELA	BOUGIE	6
26	CM67F-11325-01A	67F-11325-01	ÁNODO	ANODE	ANODO	ANODE	2
27	REC90430-06M03	90430-06M03	JUNTA	GASKET	GUARNIZIONE	JOINT	2
28	REC6P2-11193-00	6P2-11193-00	JUNTA TAPA DE CULATA 1	GASKET, CYLINDER HEAD COVER 1	GUARNIZIONE, COPERCHIO TESTATA 1	JOINT DE CACHE CULBUTEUR 1	1
29	REC6P2-11194-00	6P2-11194-00	JUNTA TAPA DE CULATA 2	GASKET, CYLINDER HEAD COVER 2	GUARNIZIONE, COPERCHIO TESTATA 2	JOINT DE CACHE CULBUTEUR 2	1
30	REC6P2-41122-00	6P2-41122-00	JUNTA	GASKET	GUARNIZIONE	JOINT	1
31	REC6P2-41112-00	6P2-41112-00	JUNTA	GASKET	GUARNIZIONE	JOINT	1
32	REC6P2-41114-00	6P2-41114-00	JUNTA	GASKET	GUARNIZIONE	JOINT	2
33	REC93102-63004	93102-63008	RETÉN DE ACEITE	OIL SEAL	PARAOLIO	JOINT SPI	1
34	PAPS2700.04.03	51Y-12119-00	RETÉN DE ACEITE	OIL SEAL	PARAOLIO	JOINT SPI	24
35	REC93102-38008	93102-38008	RETÉN DE ACEITE	OIL SEAL	PARAOLIO	JOINT SPI	4
36	REC6P2-46241-02	6P2-46241-01	CORREA DISTRIBUCIÓN	BELT, TIMING	CINGHIA DISTRIBUZIONE	COURROIE DISTRIBUTION	1

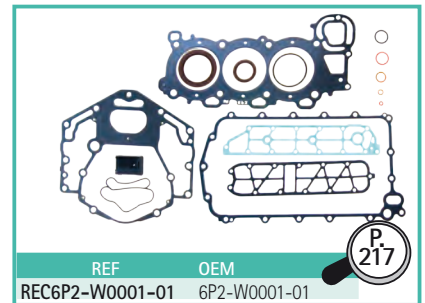
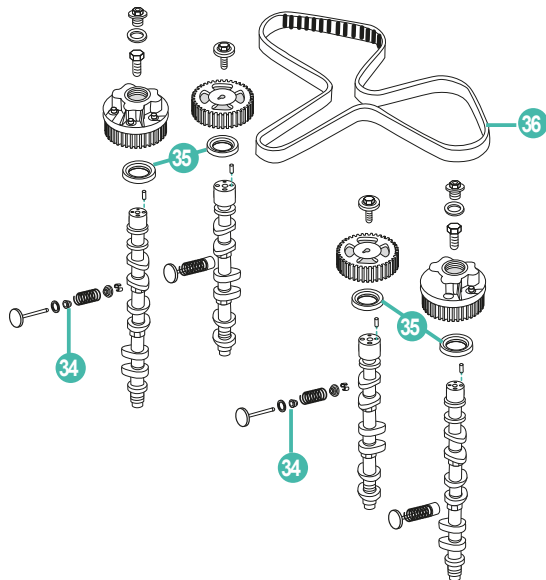



4T F300A • F350A  
STROKES



REC10W30U3  
REC10W30U6  
REC10W40U3  
REC10W40U6

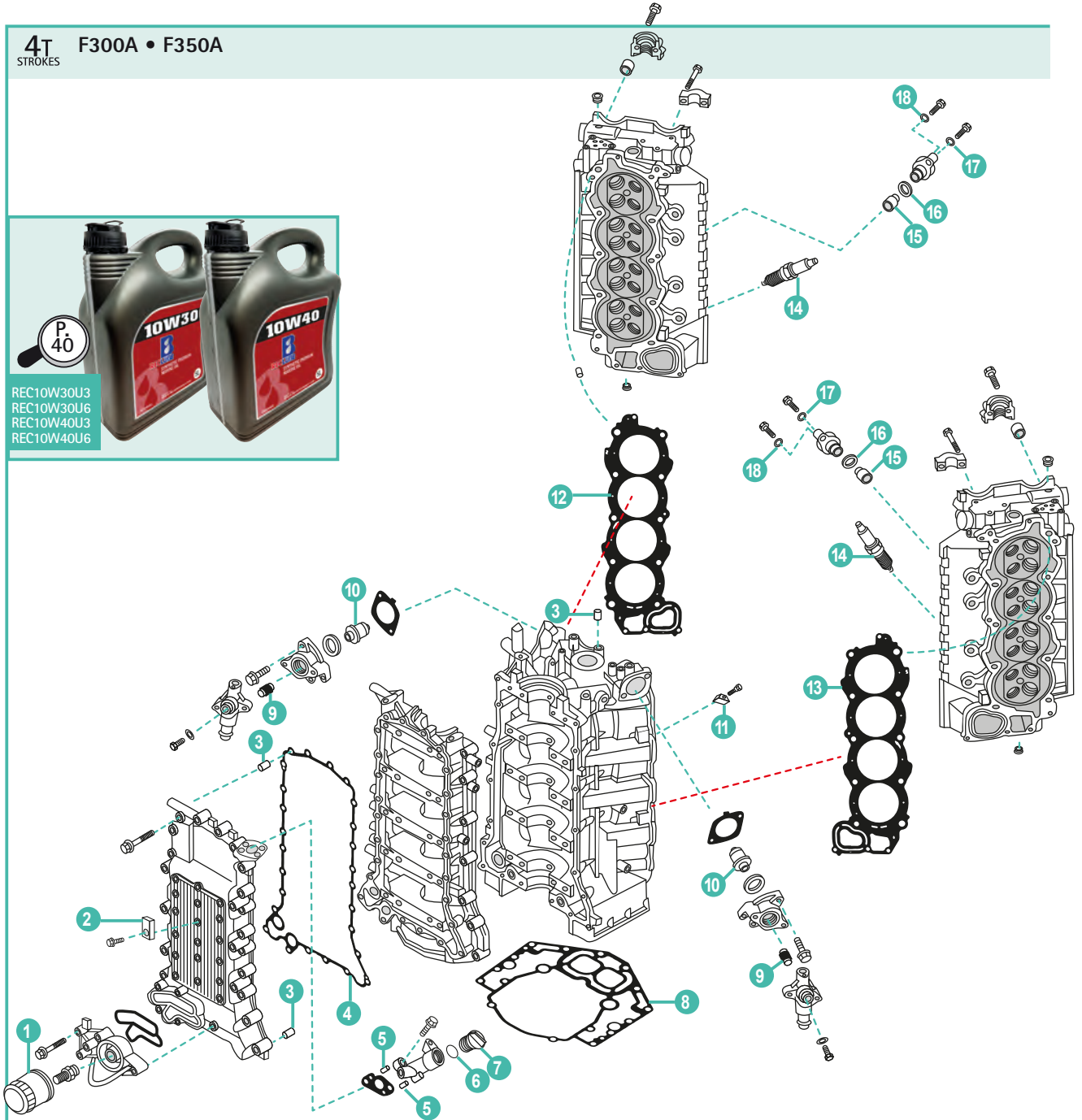

	REF	OEM				UN.	
1	REC26-13440-00	N26-13440-00	FILTRO ACEITE	OIL FILTER	FILTRO DELL'OLIO	FILTRE À HUILE	1
2	CM63P-11325-01A	63P-11325-01	ÁNODO	ANODE	ANODO	ANODE	3
3	REC93606-12019	93606-12019	PIN CENTRADOR	HOLLOW PIN	SPINOTTO DI CENTRAGGIO	PIN DE CENTRAGE	5
4	REC6AW-15451-00	6AW-15451-00	JUNTA CÁRTER	CRANK CASE COMPLEX GASKET	GUARNIZIONE COPPA L'OLLIO	JOINT DE CACHE CULBUTEUR	1
5	PAF25-04000007	93604-08062	PIN CENTRADOR	HOLLOW PIN	SPINOTTO DI CENTRAGGIO	PIN DE CENTRAGE	2
6	PAJASOF40431-025	93210-24M79	TÓRICA	O-RING	O-RING	JOINT TORIQUE	1
7	PAF15-07050004	6G8-15363-00	TAPÓN ACEITE	PLUG, OIL	TAPPO OLIO	BOUCHON REMPLISSAGE D'HUILE	1
8	REC6AW-11351-00	6AW-11351-00	JUNTA BASE MOTOR	GASKET ENGINE	GUARNIZIONE BASE MOTORE	JOINT DE TETE MOTRICE	1
9	TEN01172	6AW-1132R-00	ÁNODO	ANODE	ANODO	ANODE	2
10	REC6AW-12411-00	6AW-12411-00	TERMOSTATO	THERMOSTAT	TERMOSTATO	THERMOSTAT	2
11	TEN01177	6AW-1132P-00	ÁNODO	ANODE	ANODO	ANODE	8
12	REC6AW-11182-00	6AW-11182-00	JUNTA DE CULATA 2	HEAD GASKET 2	GUARNIZIONE TESTATA 2	JOINT DE CULASSE 2	1
13	REC6AW-11181-00	6AW-11181-00	JUNTA DE CULATA 1	HEAD GASKET 1	GUARNIZIONE TESTATA 1	JOINT DE CULASSE 1	1
14	NGKLF6A-11	94702-00400	BUJÍA	SPARK PLUG	CANDELE	BOUGIE	8
15	TEN01170	6AW-11325-00	ÁNODO	ANODE	ANODO	ANODE	2
16	REC67F-11328-00	67F-11328-00	TAPÓN	CAP	TAPPO	BOUCHON	2
17	REC90430-06M03	90430-06M03	JUNTA	GASKET	GUARNIZIONE	JOINT	2
18	PAGB/T97.1-8	92995-08600	ARANDELA	WASHER	RONDELLA	RONDELLE	2

4T  
STROKES

JUNTAS DE MOTOR  
4 TIEMPOS

ENGINE GASKET  
4 STROKES

GUARNIZIONI DE  
MOTORE 4 TEMPI

JOINTS DE MOTEUR  
4 TEMPS

JUNTAS DE CULATA

CYLINDER HEAD GASKET

GUARNIZIONE DE TESTATA

JOINTS DE CULASSE

REF	OEM
PAF2.6-04000001	69M-11181-00

F2.5 (2003+)



P. 173

REF	OEM
PAF4-04000014	67D-11181-A0

F4 (1998-2009)



P. 175

REF	OEM
PAF6-04000002	6BX-11181-00

F4B/M (2010+)  
F5A/M (2010+)  
F6C/M (2010+)



new

P. 176

REF	OEM
REC6G8-11181-A1	6G8-11181-A1

F8/9.9 (1985-05)



P. 181

REF	OEM
PAF15-07000100	66M-11181-10

F9.9/13.5/15 (1998-08)

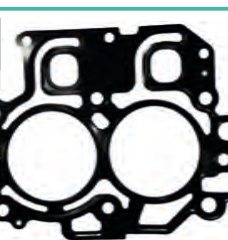

P. 185

REF	OEM
REC6AG-11181-00	6AG-11181-00

F9.9/15/20 (2007+)



P. 187

REF	OEM
REC6BL-11181-00	6BL-11181-00

F20/25  
FT25  
T25 (2009+)

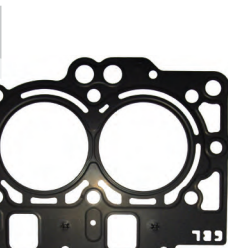

P. 195

REF	OEM
PAF25-05040000	65W-11181-30

F20/25  
T25  
F45/50 (1998-09)

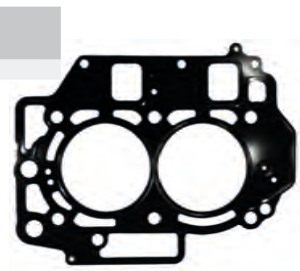

P. 191

REF	OEM
REC67C-11181-01	67C-11181-01

F30/40 (2000-09)

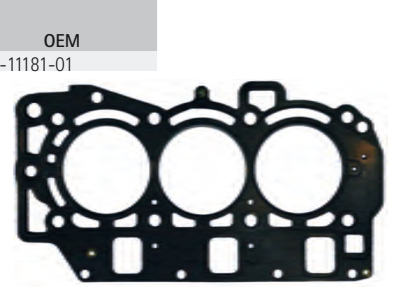

P. 197

REF	OEM
REC6BG-11181-00	6BG-11181-00

F30/40 (2009+)

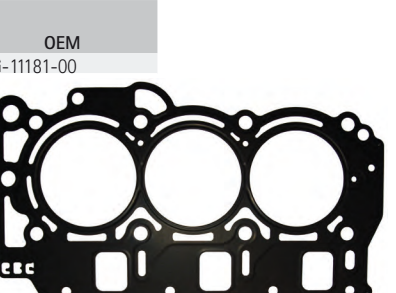

P. 201

REF	OEM
REC6CJ-11181-00	6CJ-11181-00

F40GE/70 (2011+)

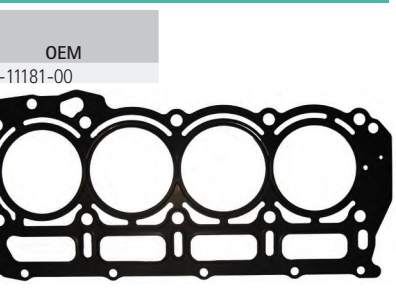

P. 205

REF	OEM
REC67F-11181-03	67F-11181-03

F75/80/100/115 (1999+)

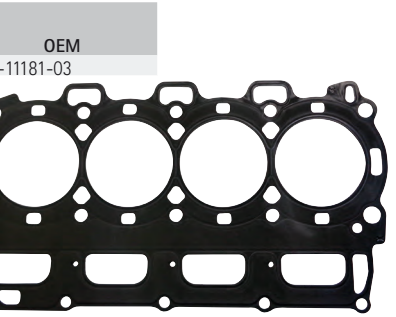

P. 209

REF	OEM
REC63P-11181-00	63P-11181-00

F150  
FL150 (2004+)

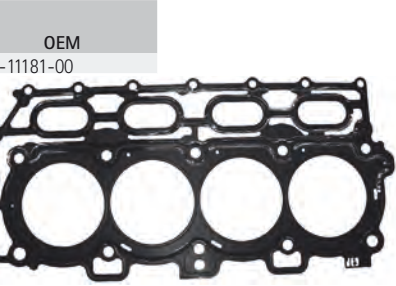

P. 211

YAMAHA

RECAMBIOS  
MARINOS

REF	OEM
REC6DA-11181-00	6DA-11181-00

F175/200  
FL200 (2013+)

REF	OEM
REC6CB-11181-00	6CB-11181-00

F225/250/300  
LF-FL225/250/300 (2011+)

REF	OEM
REC6P2-11182-00	6P2-11182-00
REC6P2-11181-00	6P2-11181-00

F200/225/250  
FL-LF 200/225/250 (2006-13)

P. 213

REC6P2-11182-00

REC6P2-11181-00

REF	OEM
REC6AW-11181-00	6AW-11181-00
REC6AW-11182-00	6AW-11182-00

F300/FL300  
(2008+)

P. 214

BABOR | PORT | BABORDO | GAUCHE  
ESTRIBOR | STD | TRIBORDO | DROIT

REC6AW-11181-00

REC6AW-11182-00

REF	OEM
REC69J-11182-03	69J-11182-03
REC69J-11181-03	69J-11181-03

F200/225  
FL200/225 (2002-07)

BABOR | PORT | BABORDO | GAUCHE  
ESTRIBOR | STD | TRIBORDO | DROIT

REC69J-11182-03

REC69J-11181-03

4T  
STROKES

**KITS JUNTAS DE CULATA** **CYLINDER HEAD GASKET KIT**

REF	OEM
REC6G8-W0001-A3	6G8-W0001-A3

F9.9 (1996-06)  
F8BM (1996-99)

**KIT GUARNIZIONE TESTATA** **KITS JOINTS DE CULASSE**

REF	OEM
REC66M-W0001-01	66M-W0001-01

F15 (2001-04)  
F13.5 (2002-04)  
FT 9.9/T9.9 (2001-04)  
F9.9 (2001-04)



REF	OEM
REC65W-W0001-00	65W-W0001-00

F20/25 (1998-01)  
T25/FT25 (2000-01)

REF	OEM
REC6P2-W0001-01	6P2-W0001-00 6P2-W0001-01

FL/LF/F250 AET/TX  
6P22 / 6P32 (2006)  
FL/F200C 6AL1-6AM6 (2006-11)  
FL/F225B/C 6AS1-6BBA (2007-11)  
LF/FL/F250A/B/T 6BR2-6P36 (2007-11)

REF	OEM
REC67C-W0001-01	67C-W0001-00 67C-W0001-01

F30 ALL  
F40ALL (2000-09)

REF	OEM
REC67F-W0001-00	67F-W0001-00

F75 (2003-17)  
F80 (1999-03)  
F100 (1999-03)  
F90 (2003-17)  
F115 (2000-15)

4T  
STROKES

JUNTAS BASE DE MOTOR CYLINDER GASKET

REF	OEM
PAF2.6-00000003	69M-45113-A0

F2.5

REF	OEM
PAF6-00000001	6BX-45113-A0

F4/F5/F6

REF	OEM
PAF4-00000006	67D-45113-A0

F4

GUARNIZIONE BASE MOTORE JOINTS DE TÊTE MOTRICE

REF	OEM
PAF15-00000014	66M-11351-10

T/FT9.9  
F9.9  
F15  
F13.5

REF	OEM
REC6G8-11351-A0	6G8-11351-A0

T/FT 9.9  
F9.9  
F8

REF	OEM
PAF25-00000013	65W-11351-10

F20  
F25  
T/FT25

YAMAHA

RECAMBIOS  
MARINOS



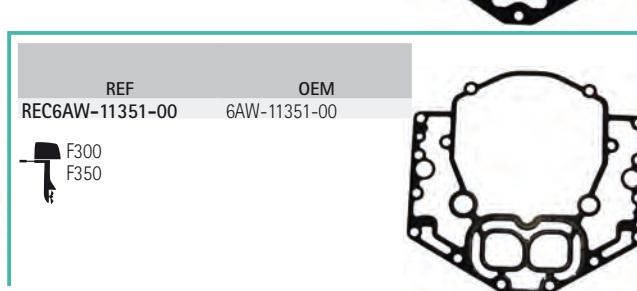
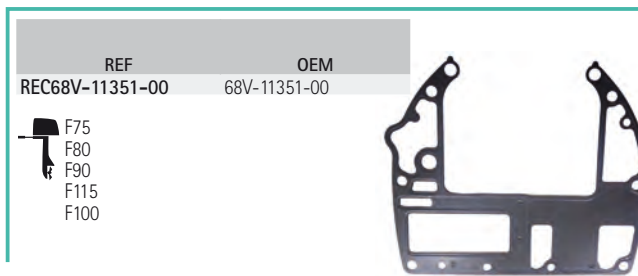
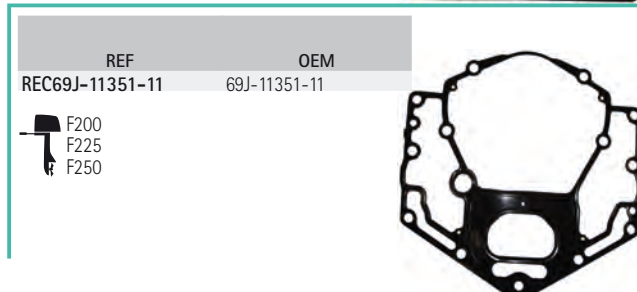
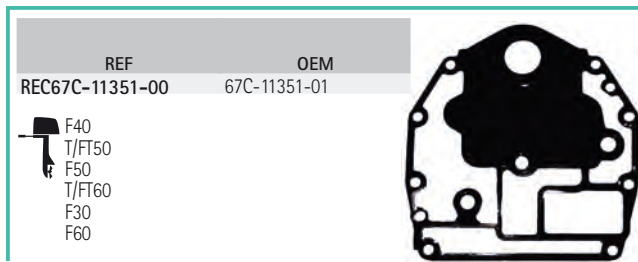
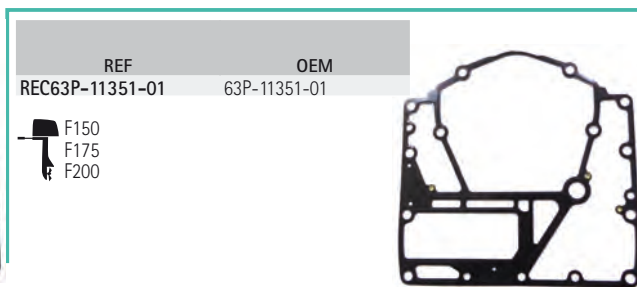
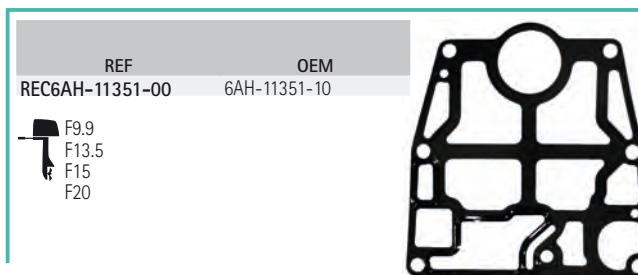

4T  
STROKES

GUÍA JUNTAS DE MOTOR		ENGINE GASKET GUIDE		GUIDA GUARNIZIONE MOTORE		GUIDE JOINTS DE MOTEURS	
REF	OEM	CYL	JUNTA CULATA CYLINDER HEAD GASKET GUARNIZIONE TESTATA JOINT DE CULASSE		KIT	JUNTA BASE MOTOR CYLINDER GASKET GUARNIZIONE BASE MOTORE JOINT DE TETE MOTRICE	
			REF	OEM		REF	OEM
F2.6A/M	2003	1	PAF2.6-04000001			PAF2.6-00000003	
F4A/M	1998	1	PAF4-04000014			PAF4-00000006	
F8A/B	1985-99	2	REC6G8-11181-A1	REC6G8-W0001-A3		REC6G8-11351-A0	
F9.9A/B	1985-99	2	REC6G8-11181-A1	REC6G8-W0001-A3		REC6G8-11351-A0	
F9.9C	2001-07	2	PAF15-07000100	REC66M-W0001-01		PAF15-00000014	
F9.9H	2008	2	REC6AG-11181-00			REC6AH-11351-00	
FT9.9D, F13.5 A	2001-07	2	PAF15-07000100	REC66M-W0001-01		PAF15-00000014	
F13.5B, F15C/E/M	2008	2	REC6AG-11181-00			REC6AH-11351-00	
F15A/E/M/P	2001-07	2	PAF15-07000100	REC66M-W0001-01		PAF15-00000014	
F20B/E/M	2008	2	REC6AG-11181-00			REC6AH-11351-00	
F20D	2011	2	REC6BL-11181-00				
F20A	1998	2	PAF25-05040000	REC65W-W0001-00		PAF25-00000013	
T25/F25A/A/E/M	1998-09	2	PAF25-05040000	REC65W-W0001-00		PAF25-00000013	
T25/F25D/M/F	2009	2	REC6BL-11181-00				
F30A/E/TR, F40B/E/TR	2000-09	3	REC67C-11181-01	REC67C-W0001-01		REC67C-11351-00	
F30B, F40F	2009	3	REC6BG-11181-00				
F40G, F70A	2011	4	REC6CJ-11181-00				
F80A/B/C/TLR	1999	4	REC67F-11181-03	REC67F-W0001-00		REC68V-11351-00	
F100A/B/D/TLR	1999	4	REC67F-11181-03	REC67F-W0001-00		REC68V-11351-00	
F115A/TX/TLR	2000	4	REC67F-11181-03	REC67F-W0001-00		REC68V-11351-00	
F150A/T/B	2004	4	REC63P-11181-00			REC63P-11351-01	
F17A	2014	4	REC6DA-11181-00			REC63P-11351-01	
F200A/TX/TR	2002-07	6	REC69J-11181-03 REC69J-11182-03			REC69J-11351-11	
F200A/C, F225A/B/C	2007	6	REC6P2-11181-00 REC6P2-11182-00	REC6P2-W0001-01		REC69J-11351-11	
F200B/F/G/CA	2013	4	REC6DA-11181-00			REC63P-11351-01	
F225A/TR/TX/TUR	2002-07	6	REC69J-11181-03 REC69J-11182-03			REC69J-11351-11	
F225CA/F, F250CA/D	2011	6	REC6CB-11181-00				
F250A/B/T	2009	6	REC6P2-11181-00 REC6P2-11182-00	REC6P2-W0001-01		REC69J-11351-11	
F300A/TR, F350A/C/T	2008	8	REC6AW-11181-00 REC6AW-11182-00			REC6AW-11351-00	
F300B/CA	2011	6	REC6CB-11181-00				

# CIGÜEÑAL

# CRANKSHAFT

# ALBERO MOTORE

# VILEBREQUIN

4T  
STROKES

## GUÍA CIGÜEÑAL COMPLETO

## GUIDE CRANKSHAFT ASSY

## GUIDA ALBERO MOTORE COMPLETO

## GUIDE VILEBREQUIN COMPLET

4T STROKES			4T STROKES		
	REF			REF	
F2.5	2003-13	PAF2.6-04030000	F15	2007-19	PAF20-05020004
F4	1998-09	PAF4-04030000	F20/AE/S/TL	2003-06	PAF25-05020001
F9.9	1998-09	PAF15-07030000	F20	2007-19	PAF20-05020004
F9.9	2009-19	PAF20-05020004	T25E/TL/R/B	2000-09	PAF25-05020001
F13.5	1999-07	PAF15-07030000	F25	1999-09	PAF25-05020001
F13.5	2007-09	PAF20-05020004	F45AET	1999	PAF25-05020001
F15	1998-07	PAF15-07030000	F50TJR	1999	PAF25-05020001

# PISTONES

# PISTONS

# PISTONI

# PISTONS





4T  
STROKES

## KITS DE PISTONES





## PISTON KITS

## KIT PISTONE





## KIT PISTON

	STD	
	REF	OEM
	PAF2.6-04020001	69M-E1631-01-96
	REC69M-E1603-01	69M-E1 603-01
	PAF2.6-04020005	69M-E1633-00
	F2.5AMH/MLH/MH/MSH (2004+)	

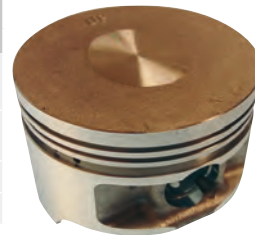





	STD	
	REF	OEM
	PAF20-05020001	6AH-11631-00
	PAF20-05020100	6AH-11603-00
	PAF20-05020003	137-11633-10
	PAF20-05020002	93450-17129
	F9.9 HMH, HE (2009+) F13.5 B, BMH (2007-09) F15 CMH, MH, ELH, CWH, CE (2007+) F20 BMH, ELH, BE, MH (2007+)	







	STD	
	REF	OEM
	PAF4-04020200	68D-E1631-00-96
	REC68D-E1603-00	68D-E1603-00
	PAF4-04020005	68D-E1633-00
	PAF4-04020006	93450-14088
	F4A/MSHA/AMH/MLHB-D/MH (2002-09)	



	STD	
	REF	OEM
	PAF25-05020100	65W-11631-00-96
	REC67C-11603-00	67C-11603-00
	PAF25-05020105	62Y-11633-00
	PAF25-05020106	93450-17129
	F20AES/AET/AE-S (2003-06) F25ELH/AE/AW/A/AET/MHZ/MHA/AM/AEH/A-ES/ T25ELRZ-T/FT25B (1998-09) F30A/ERZ/MLH/AET/ELHB/AMH/TR/AWH/ETL (2001-09) F40B/ELH/BE/ERZ/ERA/BMH/BWH (2000-09)	



	STD	
	REF	OEM
	PAF15-07020001	66M-11631-00-96
	REC66N-11603-00	66N-11603-00
	PAF15-07020006	634-11633-00
	PAF15-07020005	93450-15023
	F9.9C/CE/CMH/CWH/D (1998-08) F13.5AMH/AEH/AEP (2000-07) FT/F15A/PR/PLR/AEP/ELH/MH/AE/AM (2000-07)	



YAMAHA

RECAMBIOS MARINOS

DESPIECE MOTOR  
DE 2 TIEMPOS

ENGINE PARTS  
2 STROKES

PARTI DEL MOTORE  
2 TEMPI

PIECES MOTEUR  
2 TEMPS

2T  
STROKES 2B • 2MSH

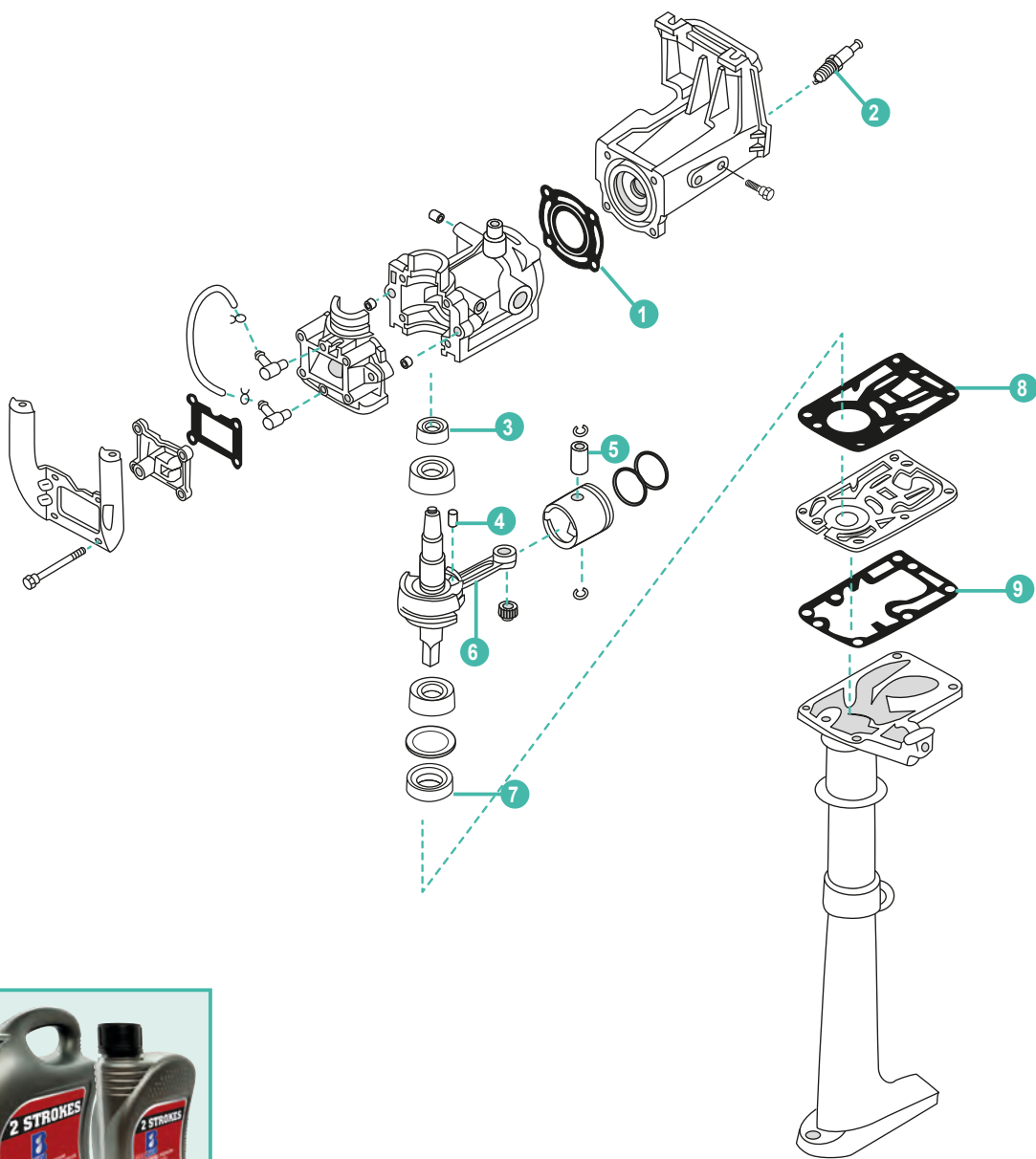

YAMAHA



	REF	OEM				UN.	
1	REC6F8-11181-A0	6F8-11181-A1	JUNTA CULATA	GASKET, CYLINDER HEAD	GUARNIZIONE TESTATA	JOINT DE CULASSE	1
2	NGKB7HS	94702-00040	BUJÍA	SPARK PLUG	CANDELA	BOUGIE	1
3	PAF2.6-04010001	93102-20070	RETÉN DE ACEITE	OIL SEAL	PARAOLIO	JOINT SPI	1
4	REC646-11681-00	646-11681-00	PIN DE BIELA	PIN, CRANK	SPINOTTO BIELLA	PIN DE BIELLE	1
5	REC646-11633-00	646-11633-00	PIN, PISTÓN	PIN, PISTON	SPINOTTO PISTONE	AXE DE PISTON	1
6	REC646-11651-02	646-11651-02	BIELA	CONNECTING ROD	BIELLA	BIELLE	1
7	REC93102-15M32	93102-15M32	RETÉN DE ACEITE	OIL SEAL	PARAOLIO	JOINT SPI	1
8	REC6A1-14613-A0	6A1-14613-A0	JUNTA TUBO DE ESCAPE	GASKET, EXHAUST PIPE	GUARNIZIONE, TUBO SCARICO	JOINT, PIPE D'ECHAPPEMENT	1
9	REC646-14623-A1	646-14623-A1	JUNTA	GASKET	GUARNIZIONE	JOINT	1

2T  
STROKES

4ACMH • 4A • 4AS • 4MSH • 4KZ • 4AC • 5C • 5CS • 5ACMH

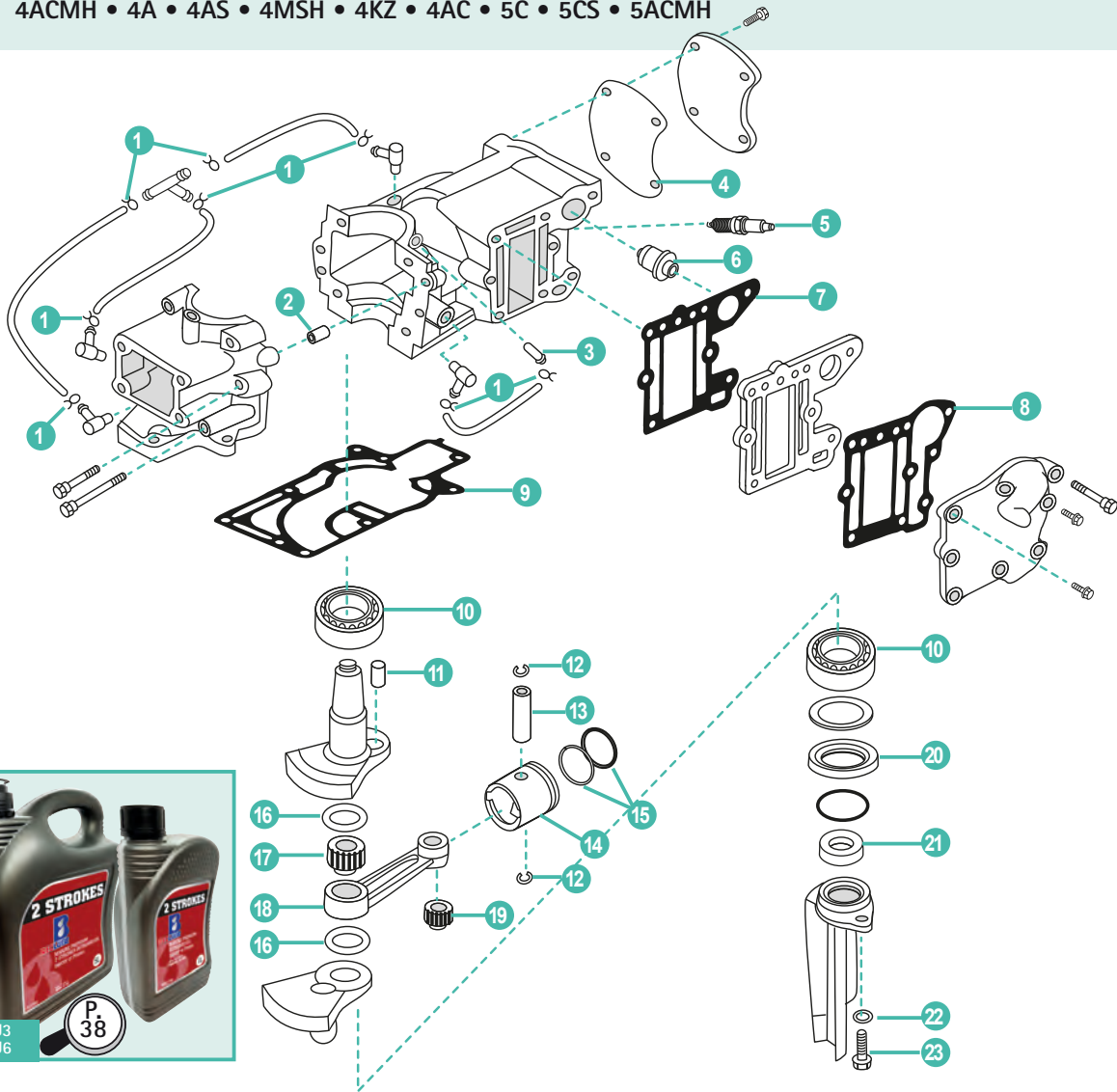

REC2TU3  
REC2TU6

REF	OEM					UN.	
1	PAHT-2.5X60	90467-06016	CLIP ABRAZADERA	CLIP	CLIP FASCETTA	COLLIER	8
2	REC93606-12019	93606-12019	PIN CENTRADOR	HOLLOW PIN	SPINOTTO DI CENTRAGGIO	PIN DE CENTRAGE	2
3	REC624-14485-00	624-14485-00	PIPA DE AGUA	PIPE, WATER	TUBO	RACCORD TUYAU D'EAU	1
4	REC6E0-11193-A1	6E0-11193-A1	JUNTA TAPA	GASKET, COVER	GAURNIZIONE COPERCHIO	JOINT COUVERCLE	1
5	NGKBR7HS	94702-00272	BUJÍA	SPARK PLUG	CANDELA	BOUGIE	1
6	REC6E5-12411-02	6E5-12411-01	TERMOSTATO	THERMOSTAT	TERMOSTATO	THERMOSTAT	1
7	REC6E0-41112-A1	6E0-41112-A1	JUNTA DE ESCAPE	EXHAUST GASKET	GUARNIZIONE DI SCARICO	JOINT D'ÉCHAPPEMENT	1
8	REC6E0-41114-A1	6E0-41114-A1	JUNTA EXTERIOR, TAPA DE ESCAPE	GASKET, EXHAUST OUTER COVER	GUARNIZIONE ESTERIORE, COPERCHIO SCARICO	JOINT DE COUVERCLE EXT ÉCHAPPEMENT	1
9	REC6E0-45113-A1	6E0-45113-A1	JUNTA BASE MOTOR	GASKET ENGINE	GUARNIZIONE BASE MOTORE	JOINT MOTEUR	1
10	REC93306-204U0	93306-204U0	RODAMIENTO	BEARING	CUSCINETTO	PALIER DE VILEBREQUIN	2
11	REC6G1-11681-00	6G1-11681-00	PIN DE CIGÜEÑAL	PIN, CRANK	SPINOTTO AALBERO MOTORE	PIN DE VILEBREQUIN	1
12	REC93450-13022	93450-13022	CIRCLIP	CIRCLIP	CIRCLIP	CIRCLIP	2
13	REC6G1-11633-00	6G1-11633-00	PIN, PISTÓN	PIN, PISTON	SPINOTTO PISTONE	AXE DE PISTON	1
14	REC6E0-11631-00-98K	6E0-11631-00-98	PISTON	PISTON STD	PISTONE	PISTON	1
15	REC6G1-11610-00	6G1-11610-00	KIT SEGMENTOS DE PISTÓN	PISTON RING KIT	KIT FASCIA PISTONE	KIT SEGMENTS	1
	REC6J1-11610-00	6J1-11610-00	KIT SEGMENTOS DE PISTÓN 5C	PISTON RING KIT 5C	KIT FASCIA PISTONE 5C	KIT SEGMENTS 5C	
16	REC90209-18112	90209-18112	ARANDELA	WASHER	RONDELLA	RONDELLE	2
17	REC93310-418V1	93310-418V1	COJINETE DE BIELA	BEARING, CONNECTING ROD	CUSCINETTO BIELLA	PALIER DE BIELLE	1
18	REC6E0-11651-01	6E0-11651-01	COJINETE DE BIELA	BEARING, CONNECTING ROD	CUSCINETTO BIELLA	PALIER DE BIELLE	1
19	REC93310-112V0	93310-112V0	RODAMIENTO	BEARING	CUSINETTO	PALIER	1
20	REC93101-20M29	93101-20M29	RETÉN DE ACEITE	OIL SEAL	PARAOLIO	JOINT SPI	1
21	REC93101-10M25	93101-10M25	RETÉN DE ACEITE	OIL SEAL	PARAOLIO	JOINT SPI	1
22	PAGB/T97.1-6	92995-06600	ARANDELA	WASHER	RONDELLA	RONDELLE	1
23	PAGB/T5783-M6X16	97095-06016	TORNILLO	BOLT	VITE	VIS	1

YAMAHA

RECAMBIOS  
MARINOS



2T  
STROKES

6CMH • 6CWH • 6MSH • 6DMH • 6MH • 6D  
8CMH • 8CWH • 8MSH • 8MH • 8D

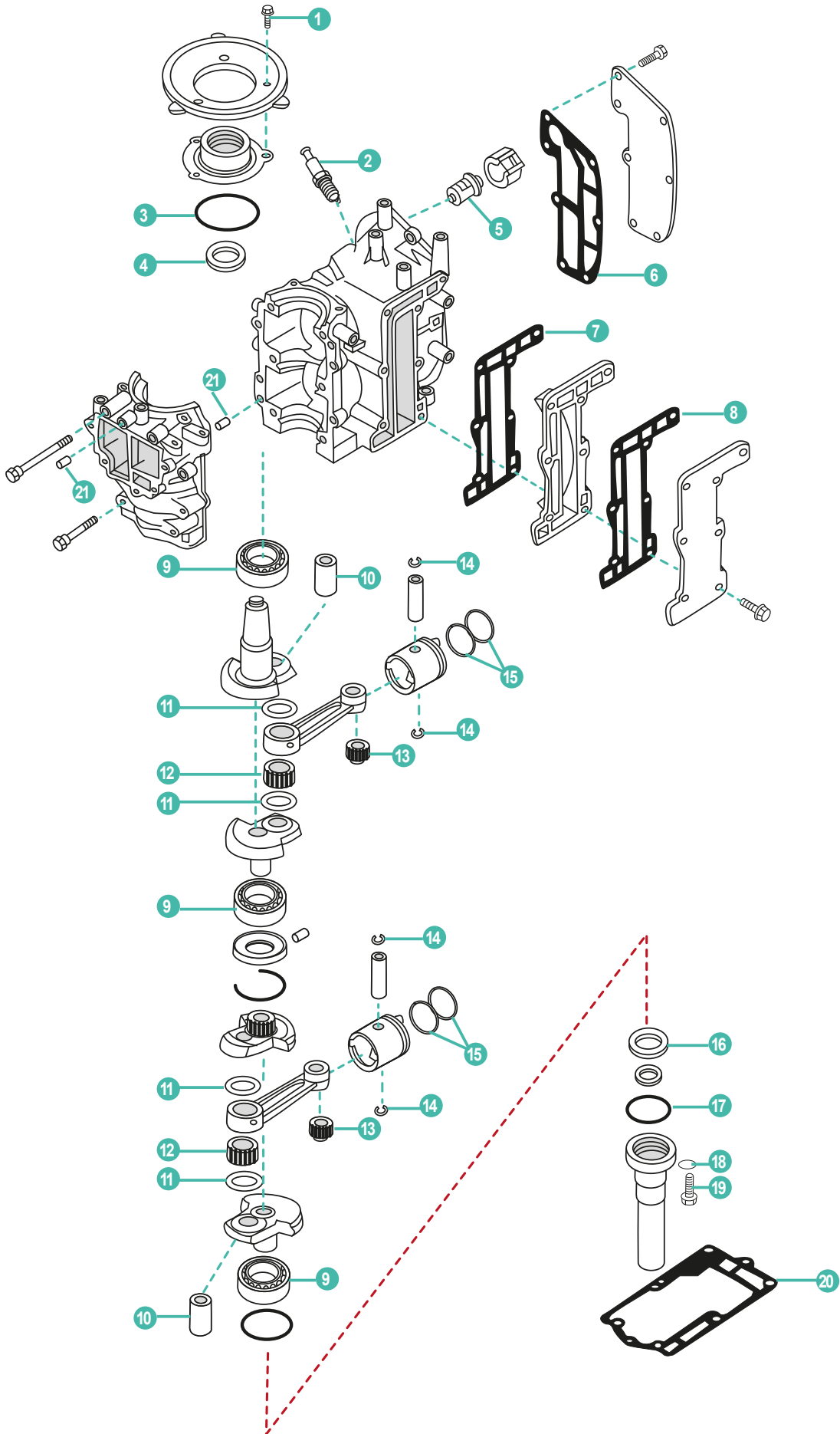

YAMAHA

RECAMBIOS  
MARINOS

	REF	OEM					UN.
1	PAGB/T5783-M5x12	97013-06016	TORNILLO	BOLT	VITE	VIS	3
2	NGKBR7HS-10	94702-00271	BUJÍA	SPARK PLUG	CANDELA	BOUGIE	2
2	NGKBR6HS-10	94702-00274	BUJÍA	SPARK PLUG	CANDELA	BOUGIE	2
3	REC93210-54M54	93210-54M54	TÓRICA	O-RING	O-RING	JOINT TORIQUE	1
4	REC93102-20M25	93102-20M25	RETÉN DE ACEITE	OIL SEAL	PARAOLIO	JOINT SPI	1
5	REC6E5-12411-02	6E5-12411-01	TERMOSTATO	THERMOSTAT	TERMOSTATO	THERMOSTAT	1
6	REC6G1-11193-A1	6G1-11193-A1	JUNTA TAPA TERMOSTATO	GASKET, THERMOSTAT COVER	GUARNIZIONE COPERCHIO TERMOSTATO	JOINT COUVERCLE DE THERMOSTAT	1
7	REC6G1-41112-A1	6G1-41112-A1	JUNTA EXTERIOR, TAPA DE ESCAPE	GASKET, EXHAUST OUTER COVER	GUARNIZIONE ESTERIORE, COPERCHIO SCARICO	JOINT DE COUVERCLE EXT ECHAPPEMENT	1
8	REC6G1-41114-A0	6G1-41114-A0	JUNTA DE ESCAPE	EXHAUST GASKET	GUARNIZIONE DI SCARICO	JOINT D'ECHAPPEMENT	1
9	REC93306-204U0	93306-204U0	RODAMIENTO	BALL BEARING	CUSCINETTO	ROULEMENT À BILLE	3
10	REC6G1-11681-00	6G1-11681-00	PIN	PIN	SPINOTTO	LEVIER D'ENTRAINEMENT	2
11	REC90209-18112	90209-18112	ARANDELA	WASHER	RONDELLA	RONDELLE	4
12	REC93310-418V1	93310-418V1	COJINETE DE BIELA	BEARING, CONNECTING ROD	CUSCINETTO BIELLA	PALIER DE BIELLE	2
13	REC93310-112V0	93310-112V0	COJINETE DE BIELA	BEARING, CONNECTING ROD	CUSCINETTO BIELLA	PALIER DE BIELLE	2
14	REC93450-13022	93450-13022	CIRCLIP	CIRCLIP	CIRCLIP	CIRCLIP	4
15	REC6G1-11610-00	6N0-E1603-00	KIT SEGMENTOS DE PISTÓN	PISTON RING SET	KIT FASCIA PISTONE	KIT SEGMENTS	2
16	REC93101-20M34	93101-20M34	RETÉN DE ACEITE	OIL SEAL	PARAOLIO	JOINT SPI	1
17	REC93210-42159	93210-42159	TÓRICA	O-RING	O-RING	JOINT TORIQUE	1
18	PAGB/T97.1-6	92995-06600	ARANDELA	WASHER	RONDELLA	RONDELLE	1
19	PAGB/T5783-M6X16	97095-06016	TORNILLO	BOLT	VITE	VIS	1
20	REC6G1-45113-A1	6G1-45113-A1	JUNTA BASE MOTOR	GASKET ENGINE	GUARNIZIONE BASE MOTORE	JOINT MOTEUR	1
21	PAF25-04000007	93604-08062	PIN CENTRADOR	HOLLOW PIN	SPINOTTO DI CENTRAGGIO	PIN DE CENTRAGE	6

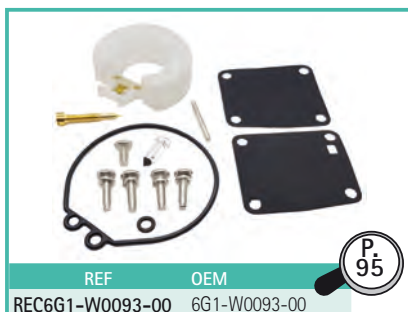
REC2TU3  
REC2TU6P  
38REF OEM  
REC6G1-W0093-00 6G1-W0093-00P  
95

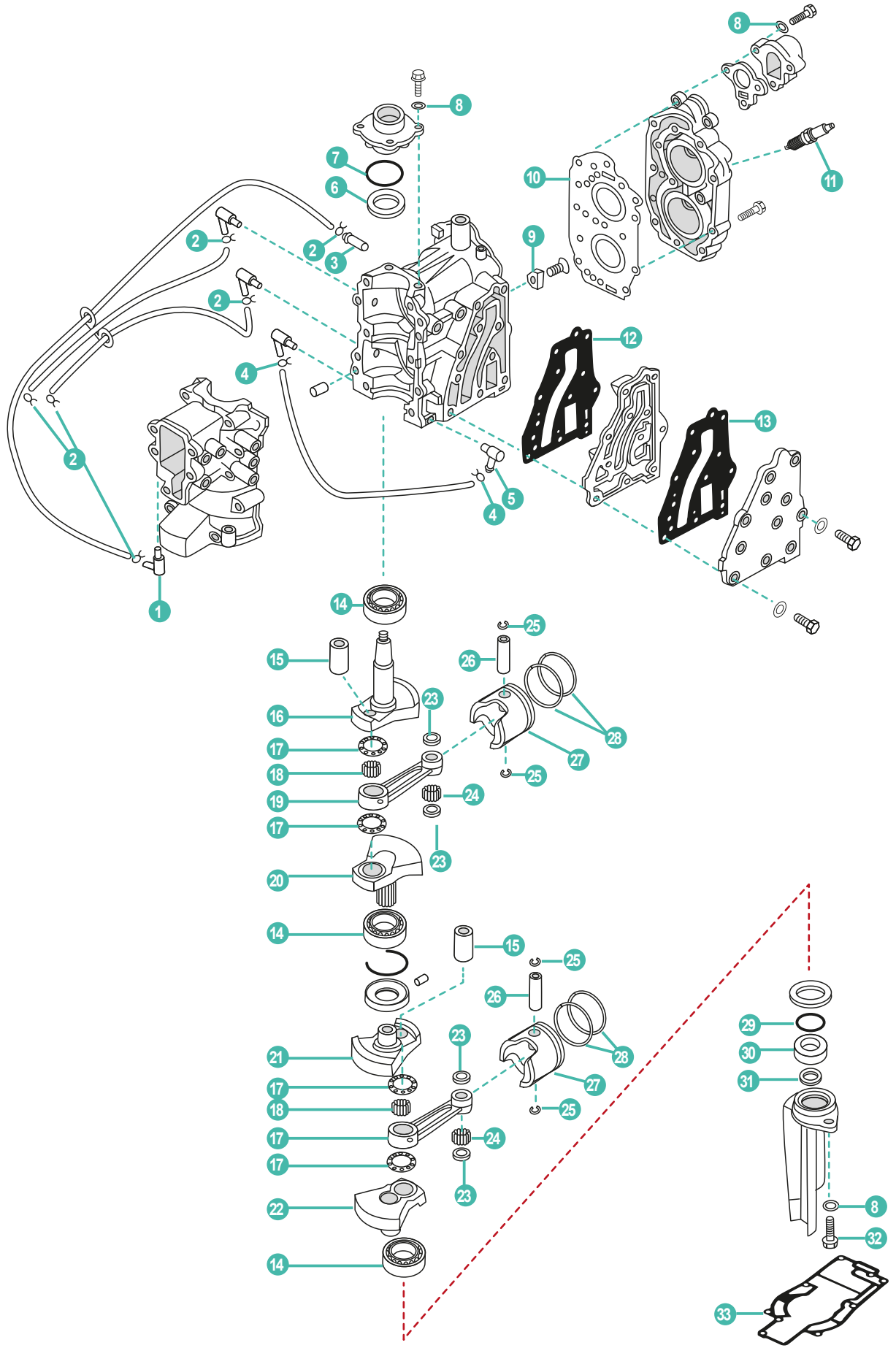

	REF	OEM				UN.	
1	REC650-11370-00	650-11370-01	NIPLE DE MANGUERA	NIPPLE	TUBO	RACCORD D'EAU	1
2	PAHT-2.5X60	90467-06016	PRESILLA	CLIP	CLIP	CLIP	6
3	REC624-14485-00	624-14485-00	PIPA DE AGUA	PIPE, WATER	TUBO	RACCORD TUYAU D'EAU	1
4	PAF4-04000030	90467-09M09	PRESILLA	CLIP	CLIP	CLIP	2
5	PAF15-04000005	676-11372-00	NIPLE DE MANGUERA	NIPPLE	TUBO	RACCORD D'EAU	1
6	REC93102-20M25	93102-20M25	RETÉN DE ACEITE	OIL SEAL	PARAOLIO	JOINT SPI	1
7	REC93210-42159	93210-42159	TÓRICA	O-RING	O-RING	JOINT TORIQUE	1
8	PAGB/T97.1-6	92995-06600	ARANDELA	WASHER	RONDELLA	RONDELLE	6
9	TEN01166	664-11325-00	ÁNODO	ANODE	ANODO	ANODE	1
10	REC677-11181-A0	677-11181-A1	JUNTA CULATA	GASKET, CYLINDER HEAD	GUARNIZIONE TESTATA	JOINT DE CULASSE	1
11	NGKB7HS-10	94702-00217	BUJÍA	SPARK PLUG	CANDELA	BOUGIE	2
12	REC677-41112-A0	677-41112-A1	JUNTA DE ESCAPE	EXHAUST GASKET	GUARNIZIONE DI SCARICO	JOINT D'ECHAPPEMENT	1
13	REC677-41112-A0	677-41114-A1	JUNTA EXTERIOR, TAPA DE ESCAPE	GASKET, EXHAUST OUTER COVER	GUARNIZIONE ESTERIORE, COPERCHIO SCARICO	JOINT DE COUVERCLE EXT ECHAPPEMENT	1
14	REC93306-204U0	93306-240U0	RODAMIENTO	BALL BEARING	CUSCINETTO	ROULEMENT À BILLE	3
15	REC6G1-11681-00	6G1-11681-00	PIN	PIN	SPINOTTO	LEVIER D'ENTRAINEMENT	2
16	REC677-11412-02	677-11412-02	CIGÜEÑAL 1	CRANK 1	ALBERO MOTORE 1	VILEBREQUIN 1	1
17	REC90209-18112	90209-18112	ARANDELA	WASHER	RONDELLA	RONDELLE	4
18	REC93310-418U0	93310-418U0	COJINETE DE BIELA	BEARING, CONNECTING ROD	CUSCINETTO BIELLA	PALIER DE BIELLE	2
19	REC6E0-11651-01	6E0-11651-01	BIELA	CONNECTING ROD	BIELLA	BIELLE	2
20	REC677-11422-02	677-11422-02	CIGÜEÑAL 2	CRANK 2	ALBERO MOTORE 2	VILEBREQUIN 2	1
21	REC677-11432-02	677-11432-02	CIGÜEÑAL 3	CRANK 3	ALBERO MOTORE 3	VILEBREQUIN 3	1
22	REC677-11442-02	677-11442-02	CIGÜEÑAL 4	CRANK 4	ALBERO MOTORE 4	VILEBREQUIN 4	1
23	REC90201-12565	90201-12565	ARANDELA PLANA	WASHER PLATE	RONDELLA PIANA	RONDELLE	4
24	REC93602-14118	93602-14118	COJINETE DE BIELA	BEARING, CONNECTING ROD	CUSCINETTO BIELLA	PALIER DE BIELLE	56
25	REC93450-13022	93450-13022	CIRCLIP	CIRCLIP	CIRCLIP	CIRCLIP	4
26	REC6G1-11633-00	6G1-11633-00	PIN, PISTÓN	PIN, PISTON	SPINOTTO PISTONE	AXE DE PISTON	2
	REC677-11631-00K	677-11631-00-97	PISTÓN STD	PISTON STD	PISTONE STD	PISTON STD	
27	REC677-11635-00K	677-11635-00	PISTÓN 0.25mm O/S	PISTON 0.25mm O/S	PISTONE 0.25mm O/S	PISTON 0.25mm O/S	2
	REC677-11636-00K	677-11636-00	PISTÓN 0.50mm O/S	PISTON 0.50mm O/S	PISTONE 0.50mm O/S	PISTON 0.50mm O/S	
	REC647-11610-00	647-11610-00	KIT SEGMENTOS STD	PISTON RING SET STD	KIT FASCE STD	KIT SEGMENTS STD	
28	REC647-11610-10	647-11610-10	KIT SEGMENTOS 0.25mm O/S	PISTON RING SET 0.25mm O/S	KIT FASCE 0.25mm O/S	KIT SEGMENTS 0.25mm O/S	2
	REC647-11610-20	647-11610-20	KIT SEGMENTOS 0.50mm O/S	PISTON RING SET 0.50mm O/S	KIT FASCE 0.50mm O/S	KIT SEGMENTS 0.50mm O/S	
29	REC93210-42M70	93210-42M70	TÓRICA	O-RING	O-RING	JOINT TORIQUE	1
30	REC93101-20M29	93101-20M29	RETÉN DE ACEITE	OIL SEAL	PARAOLIO	JOINT SPI	1
31	REC93101-14M01	93101-14M01	RETÉN DE ACEITE	OIL SEAL	PARAOLIO	JOINT SPI	1
32	PAGB/T5783-M6X16	97095-06016	PERNO	STUD	BULLONE	BOULON	2
33	REC677-45113-A0	677-45113-A0	JUNTA BASE MOTOR	GASKET ENGINE	GUARNIZIONE BASE MOTORE	JOINT MOTEUR	1



REC2TU3  
REC2TU6



REF OEM  
REC677-W0093-00 677-W0093-00



2T  
STROKES

9.9F/FM/FEM/MHV • 9.9FMH/MSH • 13.5AMH • 15F/FEM/FM/MH/MSH • 15FW/MHH



REC2TU3  
REC2TU6

P  
38

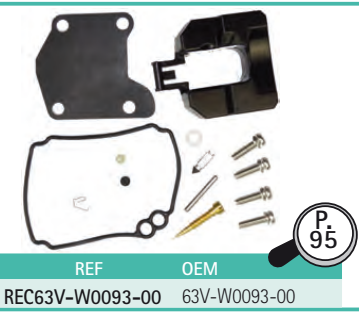
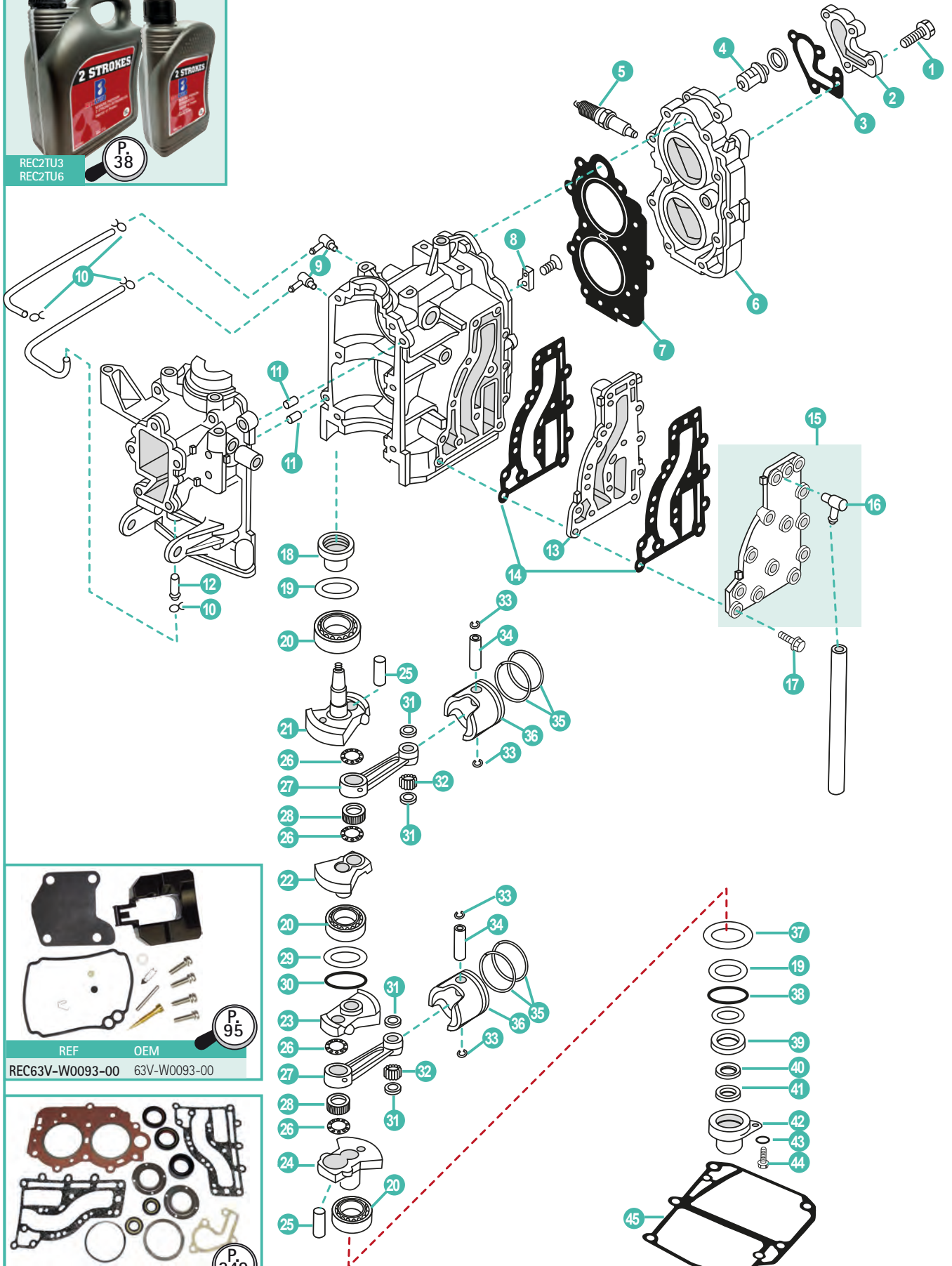

REF OEM  
REC63V-W0093-00 63V-W0093-00

P  
95

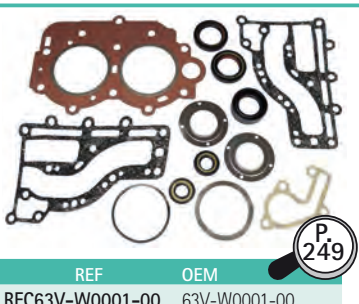

REF OEM  
REC63V-W0001-00 63V-W0001-00

P  
249

YAMAHA

RECAMBIOS  
MARINOS

	REF	OEM				UN.	
1	PAGB/T5783-M6X20	90119-06MA2	TORNILLO	BOLT	VITE	VIS	4
2	REC682-12413-00-1S	682-12413-00-1S	TAPA TERMOSTATO	COVER, THERMOSTAT	COPERCHIO TERMOSTATO	COUVERCLE DE THERMOSTAT	1
3	REC682-12414-A1	682-12414-A1	JUNTA TAPA TERMOSTATO	GASKET, THERMOSTAT COVER	GUARNIZIONE COPERCHIO TERMOSTATO	JOINT COUVERCLE DE THERMOSTAT	1
4	REC6E5-12411-30	6E5-12411-30	TERMOSTATO	THERMOSTAT	TERMOSTATO	THERMOSTAT	1
5	NGKB7HS-10	94702-00271	BUJÍA	SPARK PLUG	CANDELA	BOUGIE	2
6	REC6E7-11111-01-1S	6E7-11111-01-1S	CULATA	HEAD CYLINDER	TESTATA	CULASSE	1
7	REC63V-11181-A1	63V-11181-A2	JUNTA CULATA	GASKET, CYLINDER HEAD	GUARNIZIONE TESTATA	JOINT DE CULASSE	1
8	TEN01162	682-11325-00	ÁNODO DE ZINC	ZINC ANODE	ANODO ZINCO	ANODE ZINC	1
9	REC650-14485-03	650-14485-03	NIPLE DE MANGUERA	NIPPLE	TUBO	RACCORD D'EAU	2
10	PAHT-2.5X60	90467-06016	BRIDA	CLAMP	FLANGIA	COLLIER	4
11	REC93606-12019	93606-12019	PIN CENTRADOR	HOLLOW PIN	SPINOTTO DI CENTRAGGIO	PIN DE CENTRAGE	2
12	REC624-14485-00	624-14485-00	PIPA DE AGUA	PIPE, WATER	TUBO	RACCORD TUYAU D'EAU	1
13	REC63V-41111-00-1S	63V-41111-00-1S	PLACA ESCAPE	INNER COVER, EXHAUST	PIASTRA SCARICO	PLAQUE D'ÉCHAPPEMENT	1
14	REC63V-41112-A0	63V-41112-A0	JUNTA TAPA	GASKET, COVER	GAURNIZIONE COPERCHIO	JOINT COUVERCLE	2
15	REC63V-41113-00-1S	63V-41113-00-1S	CUBIERTA DE ESCAPE	EXHAUST COVER	COPERCHIO SCARICO	COUVERCLE D'ÉCHAPPEMENT	1
16	PAF15-04000005	676-11372-00	NIPLE DE MANGUERA	NIPPLE	TUBO	RACCORD D'EAU	1
17	PAGB/T5783-M6X30	90119-06M04	TORNILLO	BOLT	VITE	VIS	13
18	REC93110-23M00	93110-23M00	RETÉN DE ACEITE	OIL SEAL	PARAOLIO	JOINT SPI	1
19	REC63V-11445-00	63V-11445-00	ESPACIADOR	COLLAR	DISTANZIALE	ENTRETOISE	2
20	REC93306-205U7	93306-205U7	RODAMIENTO	BALL BEARING	CUSCINETTO	ROULEMENT À BILLE	3
21	REC63V-11412-00	63V-11412-00	CIGÜEÑAL 1	CRANK 1	ALBERO MOTORE 1	VILEBREQUIN 1	1
22	REC63V-11422-00	63V-11422-00	CIGÜEÑAL 2	CRANK 2	ALBERO MOTORE 2	VILEBREQUIN 2	1
23	REC63V-11432-00	63V-11432-00	CIGÜEÑAL 3	CRANK 3	ALBERO MOTORE 3	VILEBREQUIN 3	1
24	REC63V-11442-00	63V-11442-00	CIGÜEÑAL 4	CRANK 4	ALBERO MOTORE 4	VILEBREQUIN 4	1
25	REC682-11681-00	682-11681-00	PIN	PIN	SPINOTTO	PIN	2
26	REC90209-20159	90209-20M23	ARANDELA	WASHER	RONDELLA	RONDELLE	4
27	REC650-11651-04	650-11651-00	BIELA	CONNECTING ROD	BIELLA	BIELLE	2
28	REC93310-620V5	93310-620V5	COJINETE DE BIELA	BEARING, CONNECTING ROD	CUSCINETTO BIELLA	PALIER DE BIELLE	2
29	REC63V-11515-02	63V-11515-02	ARILLO	SEAL LABYRINTH	GUARNIZIONE	JOINT	1
30	REC93440-52009	93440-52008	CLIP	CLIP	CLIP	CLIP	1
31	REC90201-14377	9020-14377	ARANDELA	WASHER	RONDELLA	RONDELLE	4
32	REC93602-14104	93602-14104	AGUJAS DE RODAMIENTO	PIN DOWEL	SPILLO CUSCINETTO	AIGUILLE DE PALIER	50
33	REC93450-15023	93450-15023	CIRCLIP	CIRCLIP	CIRCLIP	CIRCLIP	4
34	REC634-11633-00	634-11633-00	PIN, PISTÓN	PIN, PISTON	SPINOTTO PISTONE	AXE DE PISTON	2
	REC682-11610-01	682-11610-01	KIT SEGMENTOS STD	PISTON RING SET STD	KIT FASCE STD	KIT SEGMENTS STD	
35	REC682-11610-11	682-11610-11	KIT SEGMENTOS 0.25mm O/S	PISTON RING SET 0.25mm O/S	KIT FASCE 0.25mm O/S	KIT SEGMENTS 0.25mm O/S	2
	REC682-11610-21	682-11610-21	KIT SEGMENTOS 0.50mm O/S	PISTON RING SET 0.50mm O/S	KIT FASCE 0.50mm O/S	KIT SEGMENTS 0.50mm O/S	
	REC6E7-11631-00K	6E7-11631-00-97	PISTÓN STD	PISTON STD	PISTONE STD	PISTON STD	
36	REC6E7-11635-00K	6E7-11635-00	PISTÓN 0.25mm O/S	PISTON 0.25mm O/S	PISTONE 0.25mm O/S	PISTON 0.25mm O/S	2
	REC6E7-11636-00K	6E7-11636-00	PISTÓN 0.50mm O/S	PISTON 0.50mm O/S	PISTONE 0.50mm O/S	PISTON 0.50mm O/S	
37	REC90201-46M29	90201-46M29	ARANDELA	WASHER	RONDELLA	RONDELLE	1
38	REC93210-46M16	93210-46M16	TÓRICA	O-RING	O-RING	JOINT TORIQUE	1
39	REC93102-25M48	93102-25M48	RETÉN DE ACEITE	OIL SEAL	PARAOLIO	JOINT D'HUILE	1
40	REC93101-25018	93101-250-18	RETÉN DE ACEITE	OIL SEAL	PARAOLIO	JOINT D'HUILE	1
41	REC93101-13018	93101-13018	RETÉN DE ACEITE	OIL SEAL	PARAOLIO	JOINT D'HUILE	2
42	REC63V-15396-01-CA	63V-15396-01-CA	CUERPO DEL RETÉN	SHELL, OIL SEAL	GUARNIZIONE CORPO	LOGEMENT JOINT SPI	1
43	PAGB/T97.1-8	92995-06600	ARANDELA	WASHER	RONDELLA	RONDELLE	1
44	PAGB/T5783-M6X16	97095-06016	TORNILLO	BOLT	VITE	VIS	1
45	REC63V-45113-A1	63V-45113-A1	JUNTA BASE MOTOR	GASKET ENGINE	GUARNIZIONE BASE MOTORE	JOINT DE TETE MOTRICE	1

2T  
STROKES

25B/BMH/BWH/VE/B07 • E25BMH/HMH • 30G/HMH/W/HWL/HWC • E30HMH

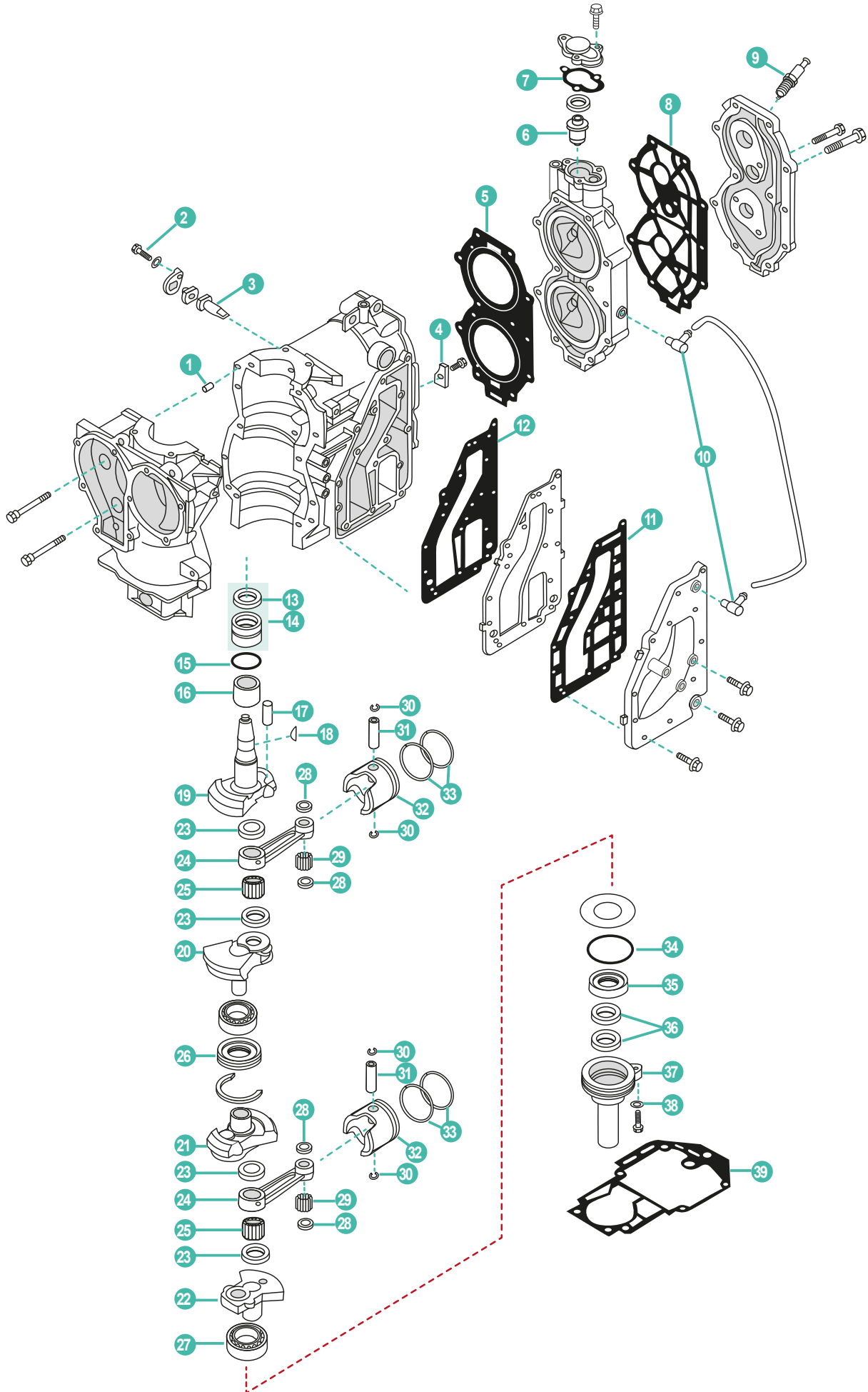

YAMAHA

RECAMBIOS  
MARINOS

	REF	OEM					UN.
1	REC93606-12019	93606-12019	PIN CENTRADOR	HOLLOW PIN	SPINOTTO DI CENTRAGGIO	PIN DE CENTRAGE	2
2	PAGB/T5783-M5X12	97013-06016	TORNILLO	BOLT	VITE	VIS	1
3	TEN01150	6J8-11325-00	ÁNODO DE ZINC	ZINC ANODE	ANODO DI ZINCO	ANODE ZINC	1
4	TEN01121	689-11325-00	ÁNODO DE ZINC	ZINC ANODE	ANODO DI ZINCO	ANODE ZINC	1
5	REC61N-11181-00	61N-11181-A1	JUNTA CULATA	GASKET, CYLINDER HEAD	GUARNIZIONE TESTATA	JOINT DE CULASSE	1
6	REC6E5-12411-02	6E5-12411-01	TERMOSTATO	THERMOSTAT	TERMOSTATO	THERMOSTAT	1
7	REC655-12414-A1	655-12414-A1	JUNTA TAPA TERMOSTATO	GASKET, THERMOSTAT COVER	GUARNIZIONE COPERCHIO TERMOSTATO	JOINT COUVERCLE DE THERMOSTAT	1
8	REC61T-11193-A0	61T-11193-A1	JUNTA TAPA DE CULATA	GASKET, CYLINDER HEAD COVER	GUARNIZIONE COPERCHIO TESTATA	JOINT COUVERCLE DE CULASSE	1
9	NGKBR7HS-10	94702-00271	BUJÍA	SPARK PLUG	CANDELA	BOUGIE	2
	NGKB7HS-10	94702-00217	BUJÍA	SPARK PLUG	CANDELA	BOUGIE	2
10	PAF15-04000005	676-11372-00	NIPLE DE MANGUERA	NIPPLE	TUBO	RACCORD D'EAU	2
11	REC6K8-41124-A1	6K8-41124-A1	JUNTA EXTERIOR, TAPA DE ESCAPE	GASKET, EXHAUST OUTER COVER	GUARNIZIONE ESTERIORE, COPERCHIO SCARICO	JOINT DE COUVERCLE EXT ECHAPPEMENT	1
12	REC6K8-41122-A1	6K8-41122-A1	JUNTA DE ESCAPE	EXHAUST GASKET	GUARNIZIONE DI SCARICO	JOINT D'ECHAPPEMENT	1
13	REC93102-32M07	93102-32M07	RETÉN DE ACEITE	OIL SEAL	PARAOILIO	JOINT SPI	1
14	REC93399-99951	93399-99951	RODAMIENTO	BEARING	CUSCINETTO	ROULEMENT À BILLE	1
15	REC93210-46M16	93210-46M16	TÓRICA	O-RING	O-RING	JOINT TORIQUE	1
16	REC90387-32002	90387-32002	COLLAR	COLLAR	COLLARE	COLLIER	1
17	REC689-11681-00	689-11681-01	PIN	PIN	SPINOTTO	PIN	2
18	REC90280-05049	90280-05049	CHAVETA	KEY WOODRUFF	CHIAVETTA	CLAVETTE	1
19	REC6G0-11412-00	69P-11412-00	CIGÜEÑAL 1	CRANK 1	ALBERO MOTORE 1	VILEBREQUIN 1	1
20	REC6G0-11422-00	69P-11422-00	CIGÜEÑAL 2	CRANK 2	ALBERO MOTORE 2	VILEBREQUIN 2	1
21	REC6G0-11432-00	69P-11432-00	CIGÜEÑAL 3	CRANK 3	ALBERO MOTORE 3	VILEBREQUIN 3	1
22	REC6G0-11442-00	69P-11442-00	CIGÜEÑAL 4	CRANK 4	ALBERO MOTORE 4	VILEBREQUIN 4	1
23	REC90209-24M03	90209-24M03	ARANDELA	WASHER	RONDELLA	RONDELLE	4
24	REC689-11651-00	689-11651-00	BIELA	ROD CONNECTING	BIELLA	BIELLE	2
25	REC93310-624U5	93310-62406	COJINETE DE BIELA	BEARING, CONNECTING ROD	CUSCINETTO BIELLA	PALIER DE BIELLE	2
26	REC61N-11515-00	61N-11515-00	ARO	SEAL, LABYRINTH	O-RING	JOINT	1
27	REC93306-305U3	93306-305U3	RODAMIENTO	BEARING	CUSCINETTO	PALIER	1
28	REC90201-20M27	90201-20M27	ARANDELA PLANA	WASHER, PLATE	RONDELLA PIANA	RONDELLE	4
29	REC93602-20M02	93602-20M02	AGUJA PASADOR	NEEDLE PIN	SPILLO	AIGUILLE	68
	REC93602-18M12	93602-18M12	AGUJAS PASADOR 25N/M & 20D/M	NEEDLE PIN 25N/M & 20D/M	SPILLO 25N/M & 20D/M	AIGUILLE 25N/M & 20D/M	
30	REC688-11634-00	688-11634-00	CIRCLIP	CIRCLIP	CIRCLIP	CIRCLIP	4
31	REC689-11633-00	689-11633-00	PIN, PISTÓN	PIN, PISTON	SPINOTTO PISTONE	AXE DE PISTON	2
	REC61N-11631-00K	61N-11631-00-95	PISTÓN STD	PISTON STD	PISTONE STD	PISTON STD	2
32	REC61N-11635-00K	61N-11635-00	PISTÓN 0.25mm O/S	PISTON 0.25mm O/S	PISTONE 0.25mm O/S	PISTON 0.25mm O/S	2
	REC61N-11636-00K	61N-11636-00	PISTÓN 0.50mm O/S	PISTON 0.50mm O/S	PISTONE 0.50mm O/S	PISTON 0.50mm O/S	2
	REC61N-11603-00	61N-11603-00	KIT SEGMENTOS STD	PISTON RING SET STD	KIT FASCE STD	KIT SEGMENTS STD	2
33	REC61N-11604-00	61N-11604-00	KIT SEGMENTOS 0.25mm O/S	PISTON RING SET 0.25mm O/S	KIT FASCE 0.25mm O/S	KIT SEGMENTS 0.25mm O/S	
	REC61N-11605-00	61N-11605-00	KIT SEGMENTOS 0.50mm O/S	PISTON RING SET 0.50mm O/S	KIT FASCE 0.50mm O/S	KIT SEGMENTS 0.50mm O/S	
34	REC93210-58M21	93210-58M21	TÓRICA	O-RING	O-RING	JOINT TORIQUE	1
35	REC93102-25008	93102-25008	RETÉN DE ACEITE	OIL SEAL	PARAOILIO	JOINT SPI	1
36	REC93101-16001	93101-16001	RETÉN DE ACEITE	OIL SEAL	PARAOILIO	JOINT SPI	2
37	REC689-15396-01-CA	689-15396-01-5B	CUERPO DEL RETÉN	SHELL, OIL SEAL	GUARNIZIONE CORPO	LOGEMENT JOINT SPI	1
38	PAGB/T97.1-8	92995-06600	ARANDELA	WASHER	RONDELLA	RONDELLE	1
39	REC61T-45113-A0	689-45113-A1	JUNTA BASE MOTOR	GASKET ENGINE	GUARNIZIONE BASE MOTORE	JOINT DE TETE MOTRICE	1

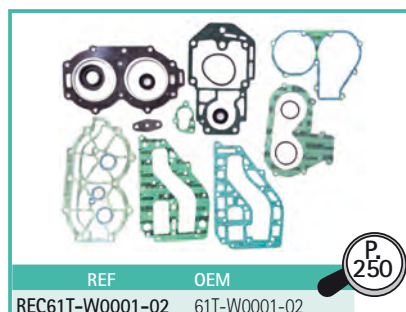



2T  
STROKES

25HP J/JEO/ESH • 30HP D/DEO/DETO • 30ELH/ELA • 30DMHO/DMSH • 30ERZ/DEL • 30MLH (1986-13)

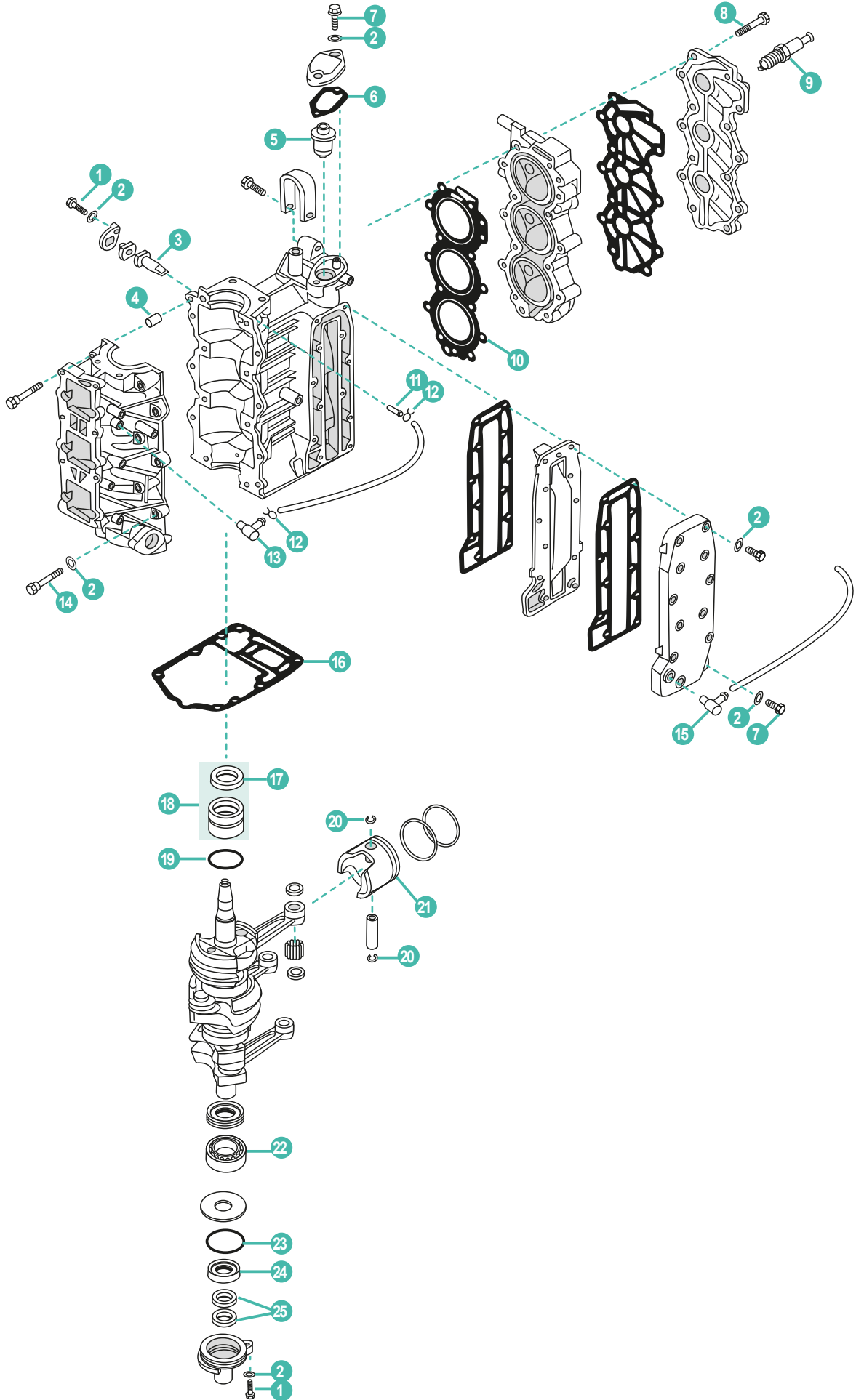

YAMAHA

RECAMBIOS  
MARINOS

	REF	OEM					UN.
1	PAGB/T5783-M6X16	97095-06016	TORNILLO	BOLT	VITE	VIS	4
2	PAGB/T97.1-6	92990-06600	ARANDELA PLANA	FLAT WASHER	RONDELLA PIANA	RONDELLE PLANE	24
3	TEN01150	6J8-11325-00	ÁNODO	ANODE	ANODO	ANODE	2
4	REC93606-12019	93606-12019	PIN CENTRADOR	HOLLOW PIN	SPINOTTO DI CENTRAGGIO	PIN DE CENTRAGE	2
5	REC6E5-12411-02	6E5-12411-01	TERMOSTATO	THERMOSTAT	TERMOSTATO	THERMOSTAT	1
6	REC61A-12414-A0	61A-12414-A0	JUNTA TAPA TERMOSTATO	GASKET, THERMOSTAT COVER	GUARNIZIONE COPERCHIO TERMOSTATO	JOINT COUVERCLE DE THERMOSTAT	1
7	PAGB/T5782-M6X25	97095-06025	TORNILLO	BOLT	VITE	VIS	3
8	REC90119-08M21	90119-08M21	TORNILLO CON ARANDELA	BOLT, FLANGE	VITE CON RONDELLA	VIS DE BRIDE	14
9	NGKBR7HS-10	94702-00271	BUJÍA	SPARK PLUG	CANDELA	BOUGIE	3
10	REC6J8-11181-A2	6J8-11181-A1	JUNTA CULATA	GASKET, CYLINDER HEAD	GUARNIZIONE TESTATA	JOINT DE CULASSE	1
11	REC624-14485-00	624-14485-00	PIPA DE AGUA	PIPE, WATER	TUBO	RACCORD TUYAU D'EAU	1
12	PAHT-2.5X60	90467-06016	PRESILLA	CLAMP	CLIP	COLLIER	2
13	REC650-11370-00	650-11370-00	NIPLA DE MANGUERA	NIPPLE	TUBO	RACCORD D'EAU	1
14	PAGB/T5783-M6X30	970-95-06030	TORNILLO	BOLT	VITE	VIS	6
15	PAF15-04000005	676-11372-00	NIPLA DE MANGUERA	NIPPLE	TUBO	RACCORD D'EAU	1
16	REC6J8-45113-00	6J8-45113-A0	JUNTA BASE MOTOR	GASKET ENGINE	GUARNIZIONE BASE MOTORE	JOINT DE TETE MOTRICE	1
17	REC93102-26M27	93102-26M27	RETÉN DE ACEITE	OIL SEAL	PARAOLIO	JOINT SPI	1
18	REC93311-632U7	93311-632U7	COJINETE DE RODILLOS	BEARING CYL	CUSCINETTO CILINDRO	ROULEMENT	1
19	REC93210-42159	93210-42159	TÓRICA	O-RING	O-RING	JOINT TORIQUE	1
20	PAF25-05020106	93450-17129	CIRCLIP	CIRCLIP	CIRCLIP	CIRCLIP	6
21	REC6J8-11631-02	6J8-11631-02-97	PISTÓN STD	PISTO STD	PISTONE STD	PISTON STD	3
22	REC93306-305U3	93306-305U3	RODAMIENTO	BALL BEARING	CUSCINETTO	ROULEMENT À BILLE	1
23	PAF15-06080003	93210-56M80	TÓRICA	O-RING	O-RING	JOINT TORIQUE	1
24	REC93101-25M35	93101-25M28	RETÉN DE ACEITE	OIL SEAL	PARAOLIO	JOINT SPI	1
25	REC93104-16M01	93104-16M04	RETÉN DE ACEITE	OIL SEAL	PARAOLIO	JOINT SPI	2



2T  
STROKES

E40X • 40XMH • E40XMH/XW/XWT

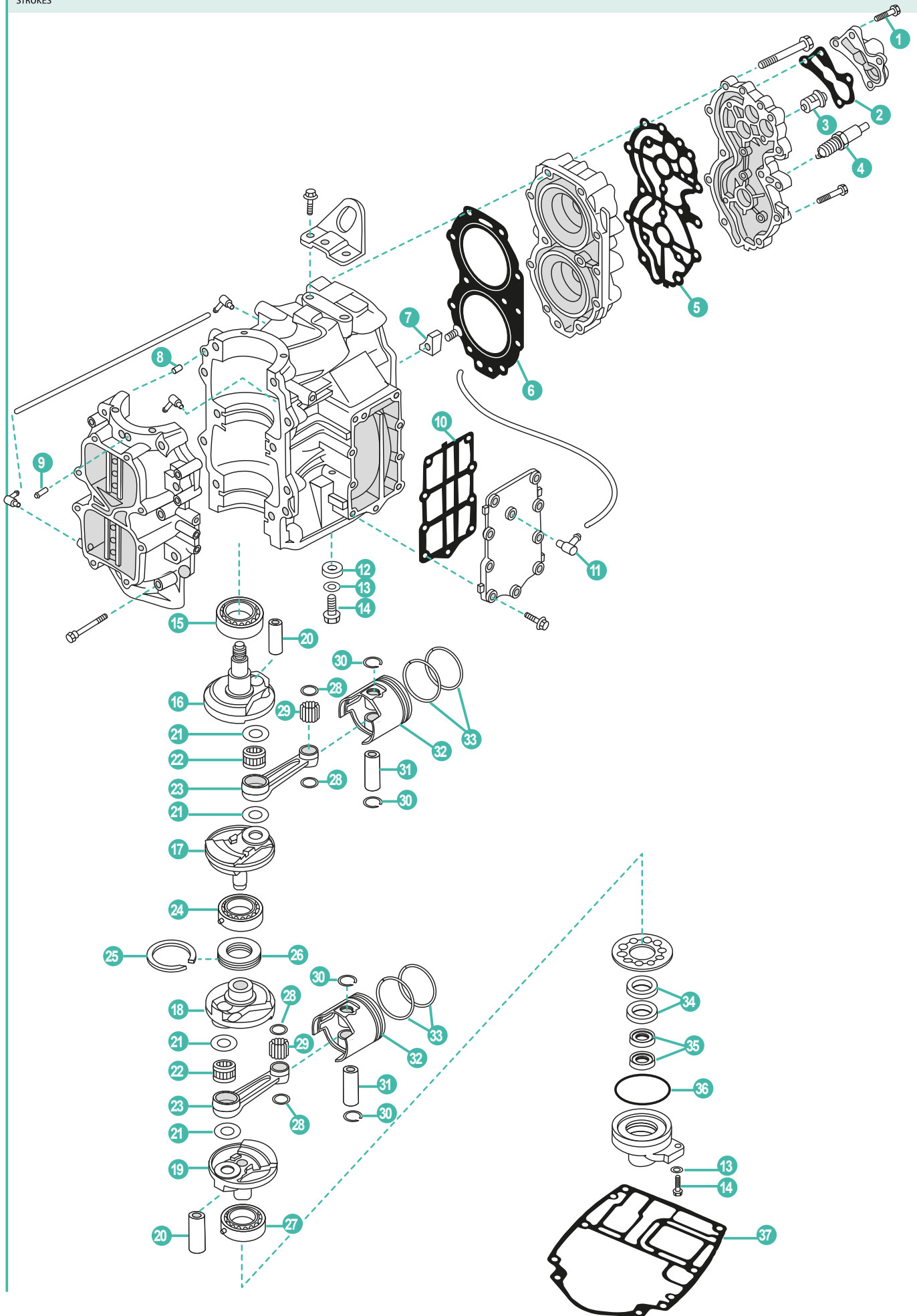

YAMAHA

RECAMBIOS  
MARINOS

	REF	OEM				UN.	
1	PAGB/T5782-M6X35	90119-06MA5	TORNILLO	BOLT WITH WASHER	VITE	VIS	4
2	REC676-12414-A0	676-12414-A0	JUNTA TAPA TERMOSTATO	GASKET, THERMOSTAT COVER	GUARNIZIONE COPERCHIO TERMOSTATO	JOINT COUVERCLE DE THERMOSTAT	1
3	REC6E5-12411-02	6E5-12411-01	TERMOSTATO	THERMOSTAT	TERMOSTATO	THERMOSTAT	1
4	NGKBR7HS	B7H-S0000-00-00	BUJÍA	SPARK PLUG	CANDELA	BOUGIE	2
5	REC66T-11193-A0	66T-11193-A0	JUNTA DE CULATÍN	HEAD VOER GASKET	GUARNIZIONE TESTATA	JOIN DE COUVRE CULASSE	1
6	REC66T-11181-00	66T-11181-A2	JUNTA CULATA	GASKET, CYLINDER HEAD	GUARNIZIONE TESTATA	JOINT DE CULASSE	1
7	TEN01166	676-11325-00	ÁNODO	ANODE	ANODO	ANODE	1
8	PAF15-00000014	93608-12063	PIN CENTRADOR	HOLLOW PIN	SPINOTTO DI CENTRAGGIO	PIN DE CENTRAGE	2
9	REC624-14485-00	624-14485-00	PIPA DE AGUA	PIPE, WATER	TUBO	RACCORD TUYAU D'EAU	1
10	REC66T-41114-A0	66T-41114-A0	JUNTA TAPA	GASKET, COVER	GUARNIZIONE COPERCHIO	JOINT COUVERCLE	1
11	PAF15-04000005	676-11372-00	NIPLE DE MANGUERA	NIPPLE	TUBO	RACCORD D'EAU	1
12	TEN01127	676-45251-00	ÁNODO	ANODE	ANODO	ANODE	1
13	PAGB/T97.1-8	92995-06600	ARANDELA	WASHER	RONDELLA	RONDELLE	2
14	PAGB/T5783-M6X20	97095-06020	TORNILLO	BOLT	VITE	VIS	2
15	REC93306-307U0	93306-307U0	RODAMIENTO	BEARING	CUSCINETTO	ROULEMENT À BILLE	1
16	REC66T-11412-00	66T-11412-00	CIGÜEÑAL 1	CRANK 1	ALBERO MOTORE 1	VILEBREQUIN 1	1
17	REC66T-11422-00	66T-11422-00	CIGÜEÑAL 2	CRANK 2	ALBERO MOTORE 2	VILEBREQUIN 2	1
18	REC66T-11432-00	66T-11432-00	CIGÜEÑAL 3	CRANK 3	ALBERO MOTORE 3	VILEBREQUIN 3	1
19	REC66T-11442-00	66T-11442-00	CIGÜEÑAL 4	CRANK 4	ALBERO MOTORE 4	VILEBREQUIN 4	1
20	REC66T-11681-00	66T-11681-00	PIN	PIN	SPINOTTO	PIN D'ENTRAÎNEMENT	2
21	REC90209-27M07	90209-27M07	ARANDELA	WASHER	RONDELLA	RONDELLE	4
22	REC93310-727U0	93310-727U0	RODAMIENTO	BEARING	CUSCINETTO	ROULEMENT	2
23	REC6F5-11651-00	6F5-11651-00	BIELA	ROD CONNECTING	BIELLA	BIELLE	2
24	REC93332-000UE	93332-000UE	RODAMIENTO	BEARING	CUSCINETTO	ROULEMENT À BILLE	1
25	REC93440-68M03	93440-68M03	CIRCLIP	CIRCLIP	CIRCLIP	CIRCLIP	1
26	REC6F5-11515-00	6F5-11515-00	ARILLO	SEAL, LABERYNTH	GUARNIZIONE TONDA	JOINT	1
27	REC93306-306V5	9306-306V5	RODAMIENTO	BEARING	CUSCINETTO	ROULEMENT	1
28	REC90201-20417	90201-20417	ARANDELA	WASHER PLATE	RONDELLA	RONDELLE	4
29	REC93603-21111	93603-21111	AGUJAS DE RODAMIENTO	PIN, DOWEL	SPINOTTO CENTRAGGIO	AIGUILLE	56
30	REC663-11634-00	633-11634-00	JUNTA	CLIP	GUARNIZIONE	JOINT	4
31	REC6F5-11633-00	6F5-11633-00	PIN, PISTÓN	PIN, PISTON	SPINOTTO PISTONE	AXE DE PISTON	2
	REC66T-11631-01K	66T-11631-01-93	PISTÓN STD	PISTON STD	PISTONE STD	PISTON STD	
32	REC66T-11635-01K	66T-11635-01	PISTÓN 0.25mm O/S	PISTON 0.25mm O/S	PISTONE 0.25mm O/S	PISTON 0.25mm O/S	2
	REC66T-11636-01K	66T-11636-01	PISTÓN 0.50mm O/S	PISTON 0.50mm O/S	PISTONE 0.50mm O/S	PISTON 0.50mm O/S	
	REC66T-11603-00	66T-11603-00	KIT SEGMENTOS STD	PISTON RING SET STD	KIT FASCE STD	KIT SEGMENTS STD	
33	REC66T-11604-00	66T-11604-00	KIT SEGMENTOS 0.25mm O/S	PISTON RING SET 0.25mm O/S	KIT FASCE 0.25mm O/S	KIT SEGMENTS 0.25mm O/S	2
	REC66T-11605-00	66T-11605-00	KIT SEGMENTOS 0.50mm O/S	PISTON RING SET 0.50mm O/S	KIT FASCE 0.50mm O/S	KIT SEGMENTS 0.50mm O/S	
34	REC93102-30M56	93102-30M56	RETÉN DE ACEITE	OIL SEAL	PARAOILIO	JOINT SPI	2
35	REC93101-16001	93101-16001	RETÉN DE ACEITE	OIL SEAL	PARAOILIO	JOINT SPI	2
36	REC93210-65M50	93210-65M50	TÓRICA	O-RING	O-RING	JOINT TORIQUE	1
37	REC66T-45113-A0	66T-45113-A00	JUNTA BASE MOTOR	GASKET ENGINE	GUARNIZIONE BASE MOTORE	JOINT DE TETE MOTRICE	1

REC2TU3  
REC2TU6

P. 38

REF OEM  
REC66T-W0093-01 66T-W0093-01

P. 96

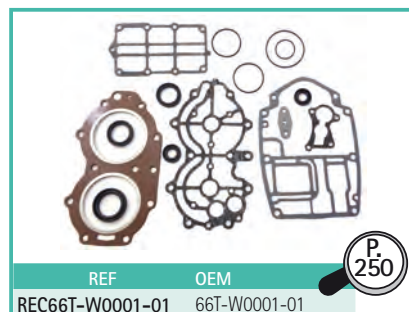
REF OEM  
REC66T-W0001-01 66T-W0001-01

P. 250



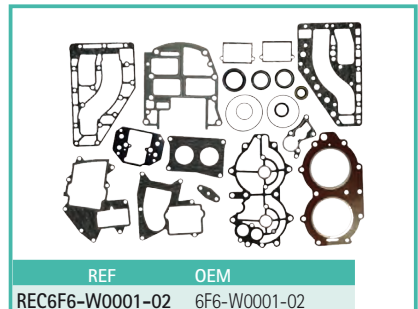
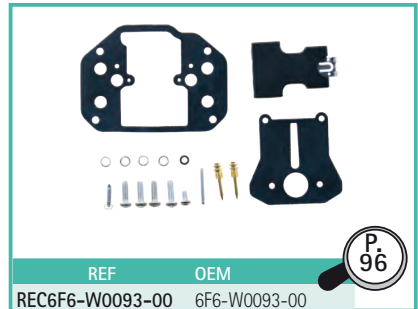
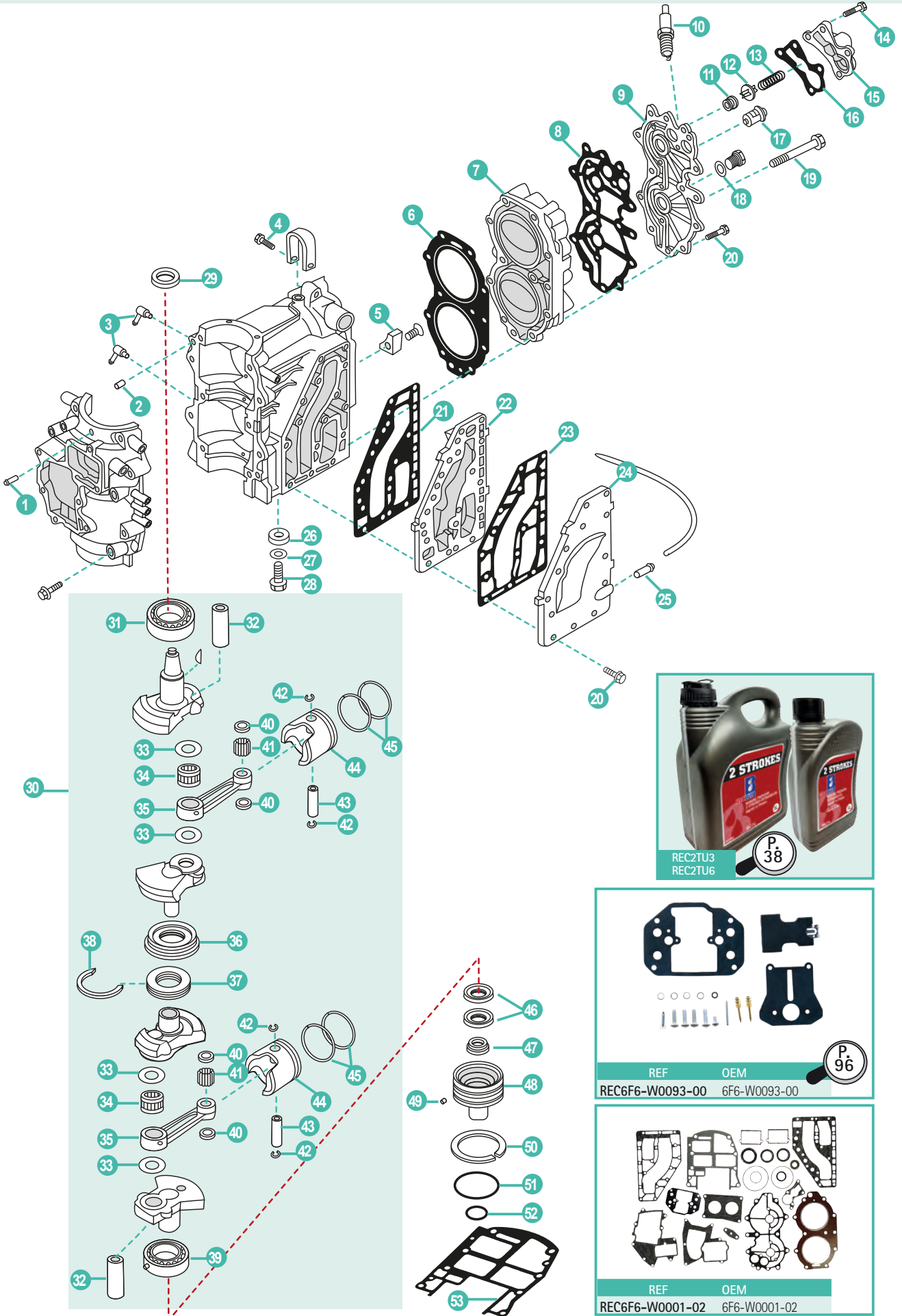

	REF	OEM					UN.
1	PAT15-04010202	624-14485-00	PIPA DE AGUA	PIPE, WATER	TUBO	RACCORD TUYAU D'EAU	1
2	PAF25-00000014	93608-12063	PIN CENTRADOR	HOLLOW PIN	SPINOTTO DI CENTRAGGIO	PIN DE CENTRAGE	2
3	REC650-11370-00	650-11370-01	NIPLE DE MANGUERA	NIPPLE	TUBO	RACCORD D'EAU	2
4	PAGB/T5783-M8X35	90101-08001	TORNILLO	BOLT	VITE	VIS	1
5	TEN01166	676-11325-00	ÁNODO	ANODO	ANODO	ANODE	1
6	REC6F5-11181-A2	6F5-11181-A1	JUNTA CULATA	GASKET, CYLINDER HEAD	GUARNIZIONE TESTATA	JOINT DE CULASSE	1
7	REC6F6-11111-00-1S	6F6-11111-00-1S	CULATA DE CILINDRO	CYLINDER HEAD	TESTA CILINDRO	CULASSE	1
8	REC6F6-11193-A1	6F6-11193-A1	JUNTA TAPA	GASKET, COVER	GUARNIZIONE COPERCHIO	JOINT DE COUVRE CULASSE	1
9	REC6F6-11191-00-1S	6F6-11191-00-1S	TAPA CULATA DE CILINDRO	HEAD CYLINDER COVER	COPERCHIO TESTATA CILINDRO	CUVERCLE DE CULASSE	1
10	NGKB7HS	94702-00040	BUJÍA	SPARK PLUG	CANDELA	BOUGIE	2
11	REC90480-18065	90480-18065	TAPÓN	PLUG	TAPPO	BOUCHON	1
12	REC663-12416-00	663-12416-00	VÁLVULA DE PRESIÓN	VALVE, PRESS CONTROL	VALVOLA DI PRESSIONE	SOUPAPE DE PRESSION	1
13	REC90501-14M02	90501-14M02	RESORTE DE COMPRESIÓN	SPRING COMPRESSION	MOLLA DI COMPRESIONE	RESSORT	1
14	PAGB/T5783-M6X30	90119-06MA4	TORNILLO CON ARANDELA	BOLT, FLANGE	VITE CON RONDELLA	VIS DE BRIDE	4
15	REC6E9-12413-00-1S	6E9-12413-00-1S	TAPA TERMOSTATO	COVER, THERMOSTAT	COPERCHIO TERMOSTATO	COUVERCLE THERMOSTAT	1
16	REC6E9-12414-A1	6E9-12414-A1	JUNTA TAPA TERMOSTATO	GASKET, THERMOSTAT COVER	GUARNIZIONE COPERCHIO TERMOSTATO	JOINT COUVERCLE DE THERMOSTAT	1
17	REC6F5-12411-03	6F5-12411-02	TERMOSTATO	THERMOSTAT	TERMOSTATO	THERMOSTAT	1
18	PAF15-04000003	90430-14115	JUNTA	GASKET	GUARNIZIONE	JOINT	1
19	PAGB/T5783-M6X25	90119-08MA5	TORNILLO	BOLT	VITE	VIS	11
20	PAGB/T5783-M6X25	90119-06MA3	TORNILLO CON ARANDELA	BOLT, FLANGE	VITE CON RONDELLA	VIS DE BRIDE	20
21	REC6F5-41112-A0	6F5-41112-A0	JUNTA DE ESCAPE	EXHAUST GASKET	GUARNIZIONE DI SCARICO	JOINT D'ECHAPPEMENT	1
22	REC6F5-41111-01-1S	6F5-41111-01-1S	CUBIERTA INTERIOR DE ESCAPE	INNER EXHAUST COVER	COPERCHIO INTERIORE SCARICO	COUVERCLE INTERIEUR D'ECHAPPEMENT	1
23	REC6F5-41114-A0	6F5-41114-A0	JUNTA EXTERIOR, TAPA DE ESCAPE	GASKET, EXHAUST OUTER COVER	GUARNIZIONE ESTERIORE, COPERCHIO SCARICO	JOINT DE COUVERCLE EXT ECHAPPEMENT	1
24	REC6F5-41113-A0-1S	6F5-41113-01-1S	CUBIERTA EXTERIOR DE ESCAPE	OUTTER EXHAUST COVER	COPERCHIO ESTERNO SCARICO	COUVERCLE EXTERIEUR D'ECHAPPEMENT	1
25	PAF4-04010102	650-24378-00	PIPA DE AGUA	PIPE, WATER	TUBO	RACCORD TUYAU D'EAU	1
26	TEN01127	676-45251-00	ÁNODO	ANODE	ANODO	ANODE	1
27	PAGB/T97.1-6	92995-06600	ARANDELA	WASHER	RONDELLA	RONDELLE	1
28	PAGB/T5783-M6X16	97095-06016	TORNILLO	BOLT	VITE	VIS	1
29	REC93102-35M18	93102-35M18	RETÉN DE ACEITE	OIL SEAL	PARAOILIO	JOINT SPI	1
30	REC6F6-11400-02	6F6-11400-01	CIGÜEÑAL COMPLETO	CRANK ASSY	ALBERO MOTORE COMPLETO	VILEBREQUIN COMPLET	1
31	REC93306-307U0	93306-307U0	RODAMIENTO	BALL BEARING	CUSCINETTO	ROULEMENT À BILLE	1
32	REC6F5-11681-00	6F5-11681-00	PIN	PIN	SPINOTTO	PIN D'ENTRAINEMENT	2
33	REC90209-27M07	90209-27M07	ARANDELA DE SEPARACIÓN	WASHER	RONDELLA DISTANZIALE	RONDELLE	14
34	REC93310-727V7	93310-727V7	COJINETE DE BIELA	BEARING, CONNECTING ROD	CUSCINETTO BIELLA	PALIER DE BIELLE	2
35	REC6F5-11651-00	6F5-11651-00	BIELA	ROD, CONNECTING	BIELLA	BIELLE	2
36	REC93332-000UE	93332-000UE	COJINETE	BEARING	CUSCINETTO	PALIER	1
37	REC6F5-11515-00	6F5-11515-00	SELLO LABERINTO	LABERINTH SEAL	GUARNIZIONE SIGILLATA	JOINT	1
38	REC93440-68M03	93440-68M03	CIRCLIP	CIRCLIP	CIRCLIP	CIRCLIP	1
39	REC93306-306V1	93306-303V1	COJINETE	BEARING	CUSCINETTO	PALIER	1
40	REC90201-20417	90201-20417	ARANDELA PLANA	FLAT WASHER	RONDELLA PIANA	RONDELLE	4
41	REC93603-21111	93603-21111	AGUJA PASADOR	NEEDLE PIN	SPILLO	CLAVETTE	56
42	REC663-11634-00	663-11634-00	CIRCLIP	CIRCLIP	CIRCLIP	CIRCLIP	4
43	REC6F5-11633-00	6F5-11633-00	PIN, PISTÓN	PIN, PISTON	SPINOTTO PISTONE	AXE DE PISTON	2
	REC6F6-11631-00K	6F6-11631-00-95	PISTÓN STD	PISTON STD	PISTONE STD	PISTON STD	
44	REC6F6-11635-00K	6F6-11635-00	PISTÓN 0.25mm O/S	PISTON 0.25mm O/S	PISTONE 0.25mm O/S	PISTON 0.25mm O/S	2
	REC6F6-11636-00K	6F6-11636-00	PISTÓN 0.50mm O/S	PISTON 0.50mm O/S	PISTONE 0.50mm O/S	PISTON 0.50mm O/S	
	REC6F5-11610-00	6F6-11610-00	KIT SEGMENTOS STD	PISTON RING SET STD	KIT FASCE STD	KIT SEGMENTS STD	
45	REC6F5-11610-10	6F6-11610-010	KIT SEGMENTOS 0.25mm O/S	PISTON RING SET 0.25mm O/S	KIT FASCE 0.25mm O/S	KIT SEGMENTS 0.25mm O/S	2
	REC6F5-11610-20	6F6-11610-20	KIT SEGMENTOS 0.50mm O/S	PISTON RING SET 0.50mm O/S	KIT FASCE 0.50mm O/S	KIT SEGMENTS 0.50mm O/S	
46	REC93101-30M33	93101-30M33	RETÉN DE ACEITE	OIL SEAL	PARAOILIO	JOINT SPI	2
47	REC93104-16M01	93104-16M01	RETÉN DE ACEITE	OIL SEAL	PARAOILIO	JOINT SPI	1
48	REC6F5-15396-01-5B	6F5-15396-01-5B	CUERPO DEL RETÉN	SHELL, OIL SEAL	GUARNIZIONE CORPO	LOGEMENT JOINT SPI	1
49	PAGB/T879.4-3X20	91690-30010	PASADOR DE RESORTE	PIN, SPRING	SPINOTO DI RITORNO	GOUPILLE FENDUE	1
50	REC93440-68M03	93440-68M03	CIRCLIP	CIRCLIP	CIRCLIP	CIRCLIP	1
51	REC93210-65M50	93210-65M50	TÓRICA	O-RING	O-RING	JOINT TORIQUE	1
52	REC93210-22M02	93210-22M02	TÓRICA	O-RING	O-RING	JOINT TORIQUE	1
53	REC6F5-45113-A0	6F5-45113-A0	JUNTA BASE MOTOR	GASKET ENGINE	GUARNIZIONE BASE MOTORE	JOINT DE TETE MOTRICE	1

2T  
STROKES

25Q/QEO · 40A/C · 40ELR · 40H/HE · 40MLHZ · 40O/OS · 40TLR · 40V/VE/VEO/VETO/VMHO · 40YETO/Z  
50D/DE · 50H/HEDO/HETO/HMHD/HWHDLO/HRDO · 50MTO

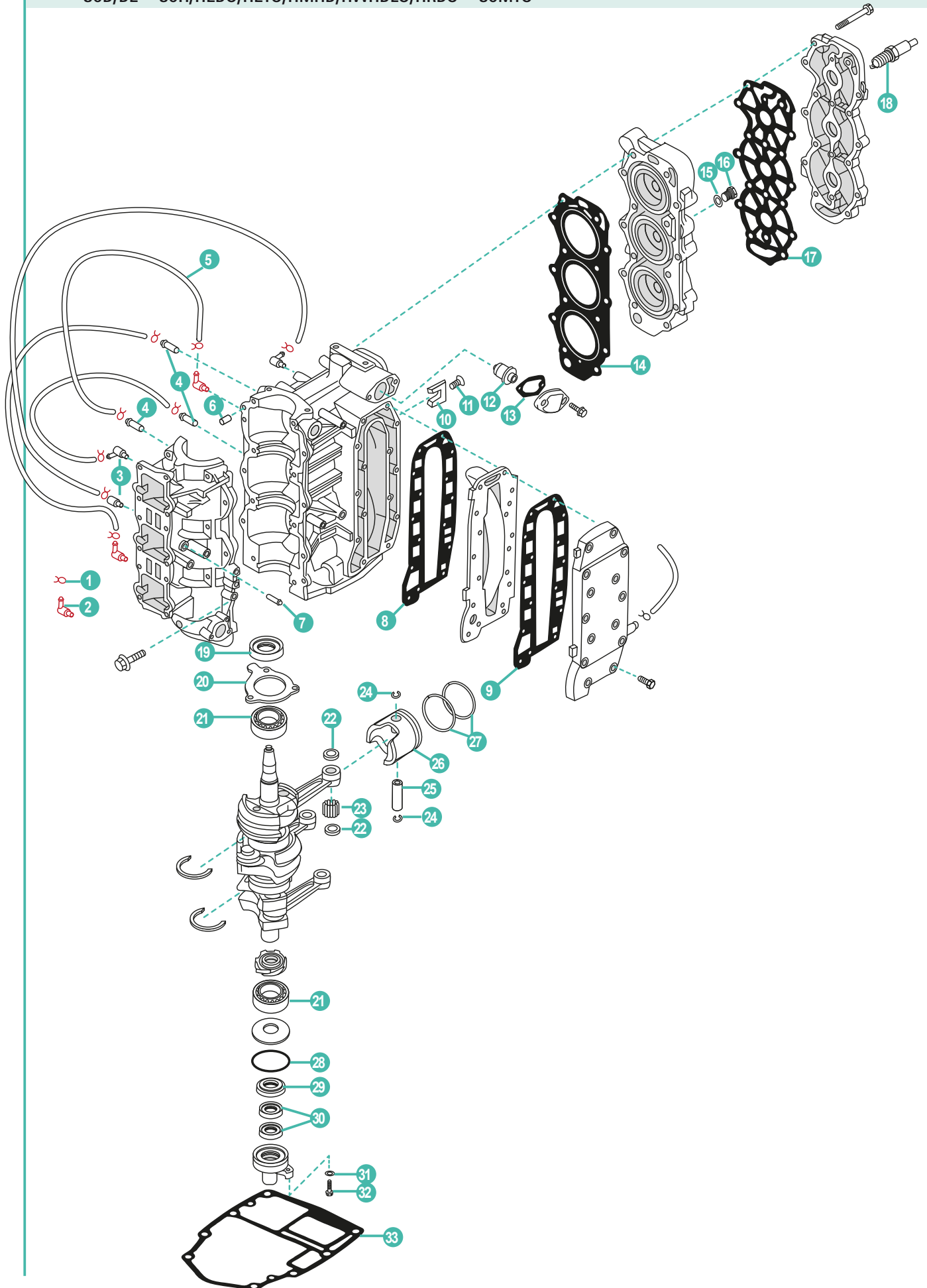

YAMAHA

RECAMBIOS  
MARINOS

	REF	OEM				UN.	
1	PAHT-2.5X60	90467-06016	CLIP	CLIP	CLIP	CLIP	8
2	REC688-11370-00	688-11370-01	NIPL DE MANGUERA	NIPPLE	TUBO	RACCORD D'EAU	2
3	REC650-11370-00	650-11370-01	NIPL DE MANGUERA	NIPPLE	TUBO	RACCORD D'EAU	2
4	REC624-14485-00	624-14485-00	PIPA DE AGUA	PIPE, WATER	TUBO	RACCORD TUYAU D'EAU	3
5	PAF2.6-04000015	90445-07MA3	TUBO L200	HOSE L200	TUBO L200	TUYAU L200	1
6	REC93606-12019	93606-12019	PIN CENTRADOR	HOLLOW PIN	SPINOTTO DI CENTRAGGIO	PIN DE CENTRAGE	2
7	PAF4-04010102	650-24378-00	PIPA DE AGUA	PIPE, WATER	TUBO	RACCORD TUYAU D'EAU	1
8	REC6H4-41112-A0	6H4-41112-A0	JUNTA DE ESCAPE	EXHAUST GASKET	GUARNIZIONE DI SCARICO	JOINT D'ECHAPPEMENT	1
9	REC6H4-41114-A0	6H4-41114-A0	JUNTA EXTERIOR, TAPA DE ESCAPE	GASKET, EXHAUST OUTER COVER	GUARNIZIONE ESTERIORE, COPERCHIO SCARICO	JOINT DE COUVERCLE EXT ECHAPPEMENT	1
10	TEN01147	688-11325-00	ÁNODO	ANODE	ANODO	ANODE	2
11	PAGB/T820-M4X12	98780-04016	TORNILLO	SCREW	VITE	VIS	2
12	REC6E5-12411-30	6E5-12411-30	TERMOSTATO	THERMOSTAT	TERMOSTATO	THERMOSTAT	1
13	REC61A-12414-A0	6J8-12414-A0	JUNTA TAPA TERMOSTATO	GASKET, THERMOSTAT COVER	GUARNIZIONE COPERCHIO TERMOSTATO	JOINT COUVERCLE DE THERMOSTAT	1
14	REC63D-11181-A1	63D-11181-A2	JUNTA CULATA	GASKET, CYLINDER HEAD	GUARNIZIONE TESTATA	JOINT DE CULASSE	1
15	PAF15-04000003	90430-14115	JUNTA	GASKET	GAURNIZIONE	JOINT	1
16	PAF15-04000002	90340-14M00	TAPÓN	PLUG	TAPPO	BOUCHON	1
17	REC63D-11193-A0	63D-11193-A0	JUNTA TAPA	GASKET, COVER	GUARNIZIONE COPERCHIO	JOINT COUVERCLE	1
18	NGKBR8HS-10	94702-00247	BUJÍA	SPARK PLUG	CANDELA	BOUGIE	3
18	NGKBR7HS-10	94702-00271	BUJÍA	SPARK PLUG	CANDELA	BOUGIE	
19	REC93102-23096	93102-23096	RETÉN DE ACEITE	OIL SEAL	PARAOLIO	JOINT SPI	1
20	REC6H4-15369-A1	6H4-15369-A1	JUNTA DE CUERPO	GASKET, OIL SEAL HOUSING	GUARNIZIONE CORPO	JOINT	1
21	REC93306-305U8	93306-305-U8	RODAMIENTO	BEARING	CUSCINETTO	PALIER	2
22	REC6H4-11641-00	6H4-11641-00	ARANDELA	WASHER	RONDELLA	RONDELLE	6
23	REC93602-20M02	93602-20M02	AGUJA DE RODAMIENTO	BEARING NEEDLE	SPILLO DE CUSCINETTO	CLAVETTE DE PALIER	93
24	REC6H4-11634-01	6H4-11634-01	CIRCLIP	CIRCLIP	CIRCLIP	CIRCLIP	6
25	REC648-11633-00	648-11633-00	PIN, PISTÓN	PIN, PISTON	SPINOTTO PISTONE	AXE DE PISTON	3
	REC6H4-11631-01K	6H4-11631-01-95	PISTÓN STD	PISTON STD	PISTONE STD	PISTON STD	
26	REC6H4-11635-01K	6H4-11635-01	PISTÓN 0.25mm O/S	PISTON 0.25mm O/S	PISTONE 0.25mm O/S	PISTON 0.25mm O/S	3
	REC6H4-11636-01K	6H4-11636-01	PISTÓN 0.50mm O/S	PISTON 0.50mm O/S	PISTONE 0.50mm O/S	PISTON 0.50mm O/S	
27	REC63D-11603-00	63D-11603-00	KIT SEGMENTOS STD	PISTON RING SET STD	KIT FASCE STD	KIT SEGMENTS STD	3
	REC63D-11605-00	63D-11605-00	KIT SEGMENTOS DE PISTÓN 0.50mm O/S	PISTON RING SET 0.50mm O/S	KIT FASCE 0.50mm O/S	KIT SEGMENTS 0.50mm O/S	
28	REC93210-58M21	93210-58M21	TÓRICA	O-RING	O-RING	JOINT TORIQUE	1
29	REC93102-25M28	93102-25M28	RETÉN DE ACEITE	OIL SEAL	PARAOLIO	JOINT SPI	1
30	REC93104-16M01	93104-16M01	RETÉN DE ACEITE	OIL SEAL	PARAOLIO	JOINT SPI	2
31	PAGB/T5783-M5X12	92995-06600	ARANDELA	WASHER	RONDELLA	RONDELLE	1
32	PAGB/T5783-M6X20	97095-06020	TORNILLO	BOLT	VITE	VIS	1
33	REC6H4-45113-00	6H4-45113-00	JUNTA BASE MOTOR	GASKET ENGINE	GUARNIZIONE BASE MOTORE	JOINT DE TETE MOTRICE	1

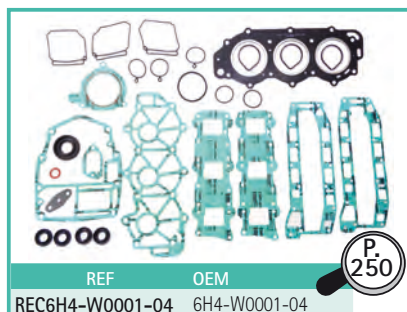
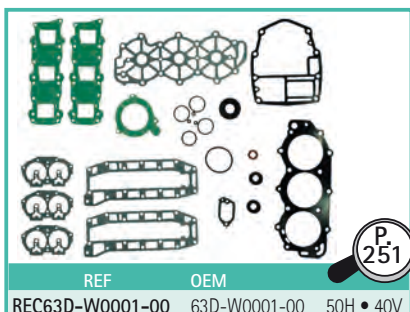



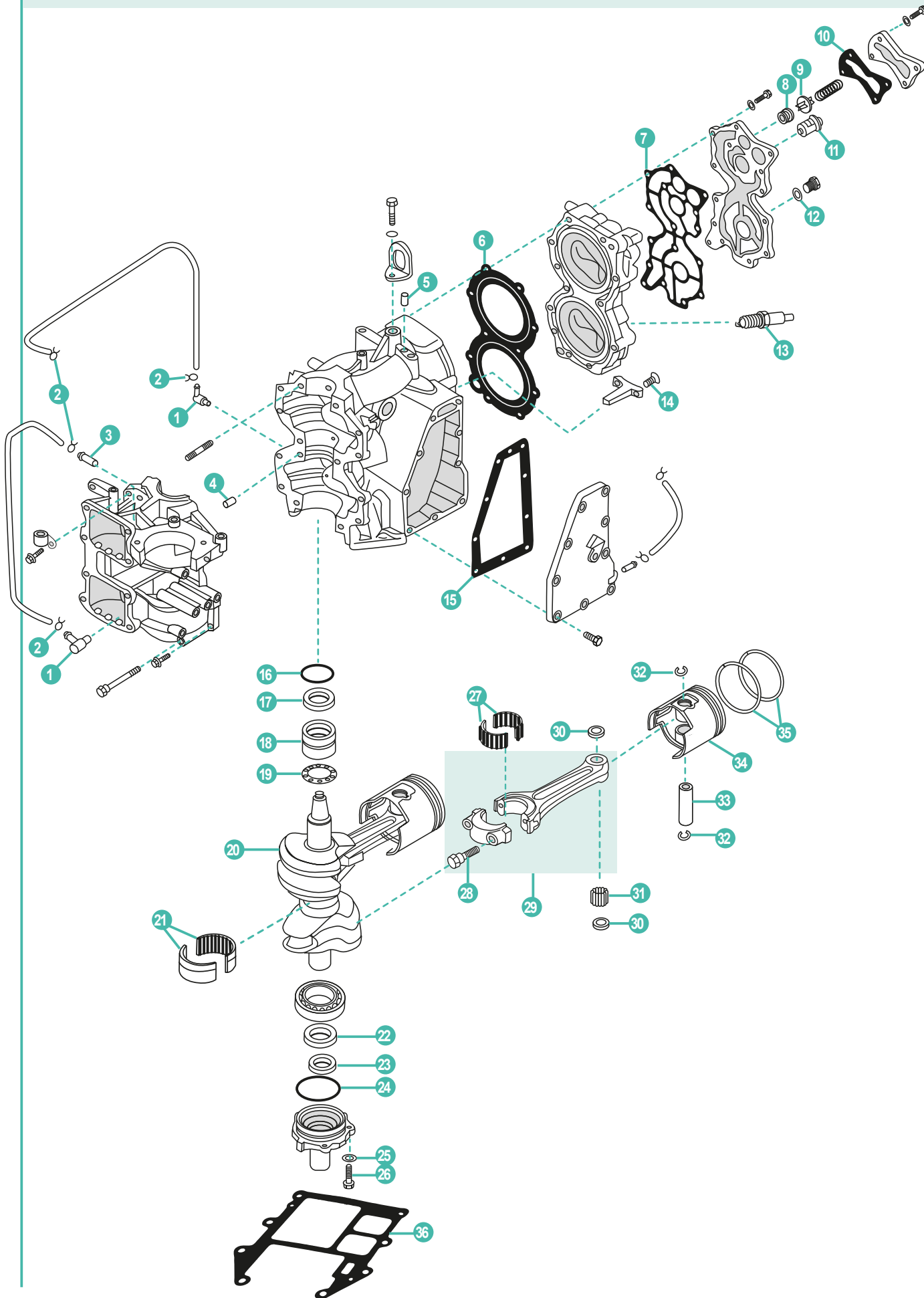

	REF	OEM				UN.	
1	REC650-11370-00	650-11370-01	NIPLE DE MANGUERA	NIPPLE	TUBO	RACCORD D'EAU	2
2	PAHT-2.5X60	90467-06016	PRESILLA	CLIP	CLIP	CLIP	4
3	REC624-14485-00	624-14485-00	PIPA DE AGUA	PIPE, WATER	TUBO	RACCORD TUYAU D'EAU	1
4	PAF25-00000014	93608-12063	PIN CENTRADOR	HOLLOW PIN	SPINOTTO DI CENTRAGGIO	PIN DE CENTRAGE	1
5	PAF25-04000007	93604-08062	PIN CENTRADOR	HOLLOW PIN	SPINOTTO DI CENTRAGGIO	PIN DE CENTRAGE	1
6	REC697-11181-A1	697-11181-A2	JUNTA CULATA	GASKET, CYLINDER HEAD	GUARNIZIONE TESTATA	JOINT DE CULASSE	1
7	REC663-11193-00	663-11193-A0	JUNTA TAPA	GASKET, COVER	GUARNIZIONE COPERCHIO	JOINT DE COUVRE CULASSE	1
8	REC90480-18065	90480-18065	TAPÓN	GROMMET	TAPPO	BOUCHON	1
9	REC663-12416-00	663-12416-00	VÁLVULA DE PRESIÓN	VALVE, PRESSURE CONTROL	VALVOLA DI PRESSIONE	SOUPAPE DE PRESION	1
10	REC663-12414-00	663-12414-A0	JUNTA TAPA TERMOSTATO	GASKET, THERMOSTAT COVER	GUARNIZIONE COPERCHIO TERMOSTATO	JOINT COUVERCLE DE THERMOSTAT	1
11	REC6F5-12411-03	6F5-12411-02	TERMOSTATO	THERMOSTAT	TERMOSTATO	THERMOSTAT	1
12	PAF15-04000003	90430-14115	JUNTA	GASKET	GUARNIZIONE	JOINT	1
	NGKB8HS-10	94702-00160	BUJÍA 55E	SPARK PLUG 55E	CANDELA 55E	BOUGIE 55E	
13	NGKB7HS	94702-00040	BUJÍA E48	SPARK PLUG E48	CANDELA E48	BOUGIE E48	2
	NGKB8HS	94702-00041	BUJÍA E55C	SPARK PLUG E55C	CANDELA E55C	BOUGIE E55C	
14	PAGB/T820-M4X12	98780-04015	TORNILLO CABEZA PLANA	SCREW, FLAT HEAD	VITE TESTA PLANA	VIS	2
15	REC663-41114-00	663-41114-A0	JUNTA DE ESCAPE	EXHAUST GASKET	GUARNIZIONE DI SCARICO	JOINT D'ECHAPPEMENT	1
16	REC93210-42159	93210-42159	TÓRICA	O-RING	O-RING	JOINT TORIQUE	1
17	REC93102-32M07	93102-32M07	RETÉN DE ACEITE	OIL SEAL	PARAOLIO	JOINT SPI	1
18	REC93311-632U1	93311-632U1	COJINETE DE RODILLOS	BEARING	CUSCINETTO A RULLI	ROULEMENT À BILLE	1
19	REC663-11561-00	663-11561-00	ARANDELA PLANA	CHIM, RANK	SPESSORE		1
20	REC663-11411-00	663-11411-01	CIGÜEÑAL	CRANK SHAFT	ALBERO MOTORE	VILEBREQUIN	1
21	REC93311-832U4	93311-832U4	COJINETE DE RODILLOS	BEARING	CUSCINETTO A RULLI	ROULEMENT À BILLE	1
22	REC93102-28135	93102-28135	RETÉN DE ACEITE	OIL SEAL	PARAOLIO	JOINT SPI	1
23	REC93104-18049	93104-18049	RETÉN DE ACEITE	OIL SEAL	PARAOLIO	JOINT SPI	1
24	REC93210-62269	93210-62269	TÓRICA	O-RING	O-RING	JOINT TORIQUE	1
25	PAGB/T97.1-6	92995-06600	ARANDELA	WASHER	RONDELLA	RONDELLE	3
26	PAGB/T5783-M6X16	97095-06016	PERNO	BOLT	PERNO	BOULON	3
27	REC93310-730V8	93310-730V8	COJINETE DE RODILLOS	BEARING	CUSCINETTO A RULLI	ROULEMENT À BILLE	2
28	REC90109-08022	90109-08022	PERNO	BOLT	PERNO	BOULON	2
29	REC688-11650-03	688-11650-03	BIELA COMPLETA	CONNECTING ROD ASSY	BIELLA COMPLETA	BIELLE COMPLÈTE	2
30	REC90201-20417	90201-20417	ARANDELA PLANA	WASHER	RONDELLA PIANA	RONDELLE	4
31	REC93603-21111	93603-21111	AGUJA DE RODAMIENTO	BEARING NEEDLE	SPILLO DE CUSCINETTO	CLAVETTE DE PALIER	56
32	REC688-11634-00	688-11634-00	CIRCLIP	CIRCLIP	CIRCLIP	CIRCLIP	4
33	REC663-11633-00	663-11633-00	PIN, PISTÓN	PIN, PISTON	SPINOTTO PISTONE	AXE DE PISTON	2
	REC688-11631-03K	688-11631-03-94	PISTÓN STD	PISTON STD	PISTONE STD	PISTON STD	
34	REC688-11635-03K	688-11635-03	PISTÓN 0.25mm O/S	PISTON 0.25mm O/S	PISTONE 0.25mm O/S	PISTON 0.25mm O/S	2
	REC688-11636-03K	688-11636-03	PISTÓN 0.50mm O/S	PISTON 0.50mm O/S	PISTONE 0.50mm O/S	PISTON 0.50mm O/S	
	REC688-11603-A0	688-11603-A0	KIT SEGMENTOS STD	PISTON RING SET STD	KIT FASCE STD	KIT SEGMENTS STD	
35	REC688-11605-A0	688-11605-A0	KIT SEGMENTOS DE PISTÓN 0.50mm O/S	PISTON RING SET 0.50mm O/S	KIT FASCE 0.50mm O/S	KIT SEGMENTS 0.50mm O/S	2
36	REC696-45113-00	696-45113-00	JUNTA BASE MOTOR	GASKET ENGINE	GUARNIZIONE BASE MOTORE	JOINT DE TETE MOTRICE	1

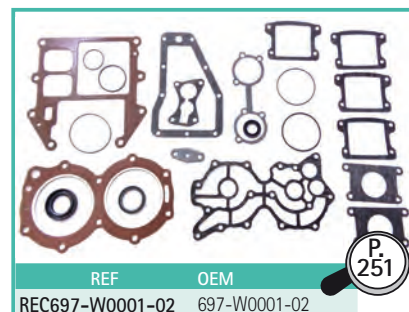
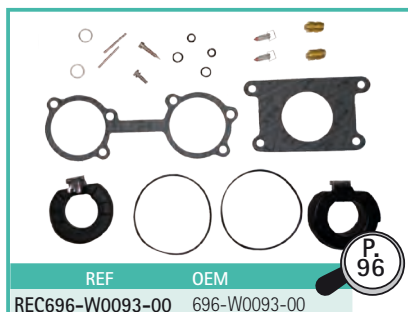

2T  
STROKES

50G/GEO/GETO • 60F/FEDO/FEHT/FEO/FET/FETO • 60TDR/TLR-B/TR-Z • 70B/BEHDO/BEMO/BEO/BETO • 70TDR/TR

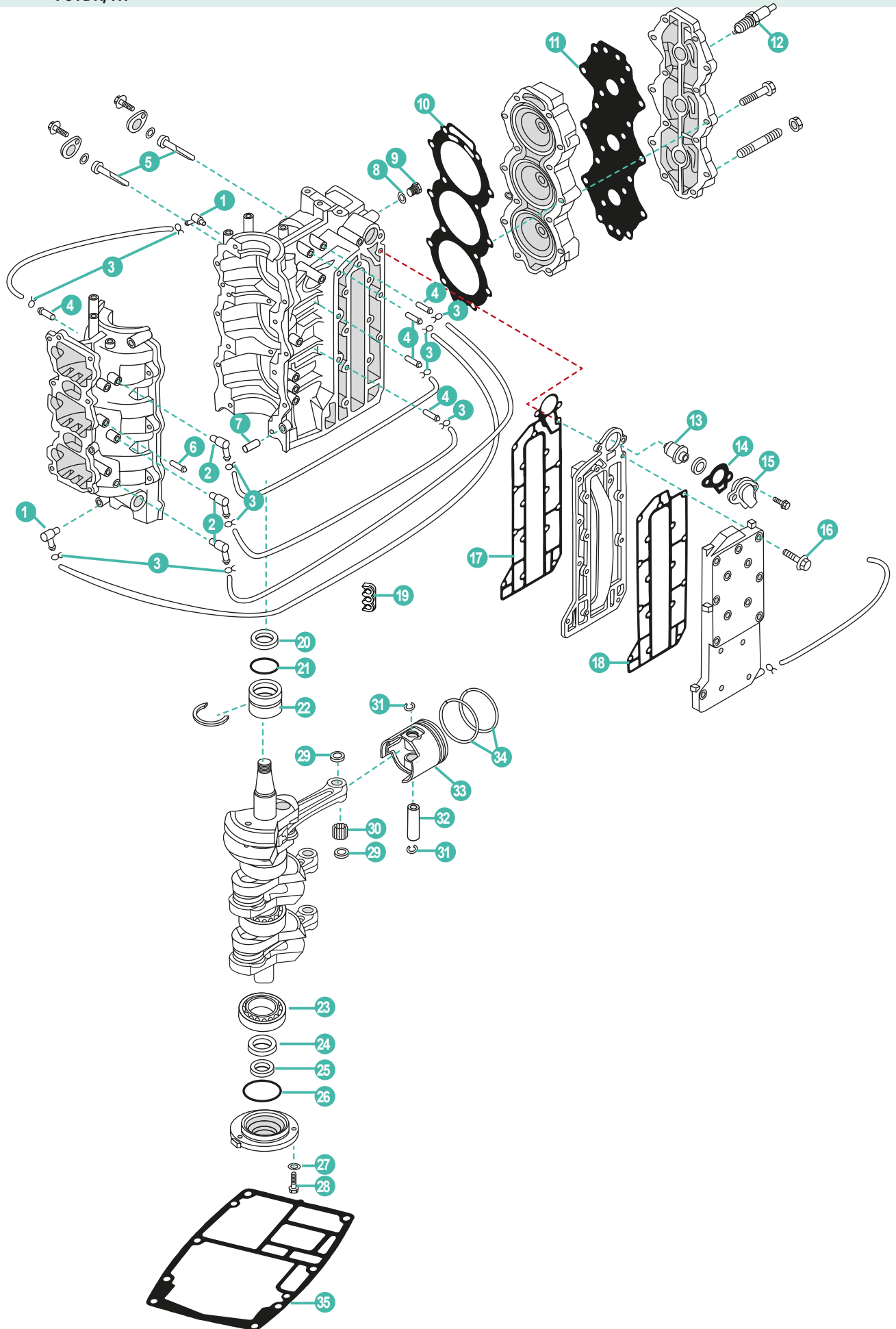

YAMAHA

RECAMBIOS  
MARINOS

	REF	OEM				UN.	
1	REC688-11370-00	688-11370-01	NIPLE DE MANGUERA	NIPPLE	TUBO	RACCORD D'EAU	2
2	REC650-11370-00	650-11370-01	NIPLE DE MANGUERA	NIPPLE	TUBO	RACCORD D'EAU	3
3	PAHT-2.5X60	90467-06016	CLIP	CLIP	CLIP	CLIP	10
4	REC624-14485-00	624-14485-00	PIPA DE AGUA	PIPE, WATER	TUBO	RACCORD TUYAU D'EAU	5
5	CM6H3-11325-01A	6H3-11325-01	ÁNODO	ANODE	ANODO	ANODE	2
6	PAF4-04010102	650-24378-00	PIPA DE AGUA	PIPE, WATER	TUBO	RACCORD TUYAU D'EAU	4
7	PAF25-00000014	93608-12063	PIN CENTRADOR	HOLLOW PIN	SPINOTTO DI CENTRAGGIO	PIN DE CENTRAGE	2
8	PAF15-04000003	90430-14115	JUNTA	GASKET	GUARNIZIONE	JOINT	1
9	PAF15-04000002	90340-14M00	TAPÓN	PLUG STRAIGHT SREW	TAPPO	BOUCHON	1
10	REC6H3-11181-A0	6H3-11181-A2	JUNTA CULATA	GASKET, CYLINDER HEAD	GUARNIZIONE TESTATA	JOINT DE CULASSE	1
11	REC6H3-11193-A1	6H3-11193-A1	JUNTA CULATÍN	GASKET COVER	GUARNIZIONE COPERCHIO	JOINT DE COUVRE CULASSE	1
12	NGKBR8HS-10	94702-00247	BUJÍA	SPARK PLUG	CANDELA	BOUGIE	3
13	REC6H3-12411-10	6H3-12411-10	TERMOSTATO	THERMOSTAT	TERMOSTATO	THERMOSTAT	1
14	REC6H3-12414-A1	6H3-12414-A1	JUNTA TAPA TERMOSTATO	GASKET, THERMOSTAT COVER	GUARNIZIONE COPERCHIO TERMOSTATO	JOINT COUVERCLE DE THERMOSTAT	1
15	PAF15-07010021	6H3-12413-00-1S	TAPA TERMOSTATO	COVER, THERMOSTAT	COPERCHIO TERMOSTATO	COUVERCLE DE THERMOSTAT	1
16	PAGB/T5782-M6X35	90119-06MA5	TORNILLO	BOLT	VITE	VIS	16
17	REC6H3-41112-A0	6H3-41112-A0	JUNTA DE ESCAPE	EXHAUST GASKET	GUARNIZIONE DI SCARICO	JOINT D'ECHAPPEMENT	1
18	REC6H3-41114-A0	6H3-41114-A0	JUNTA EXTERIOR, TAPA DE ESCAPE	GASKET, EXHAUST OUTER COVER	GUARNIZIONE ESTERIORE, COPERCHIO SCARICO	JOINT DE COUVERCLE EXT ECHAPPEMENT	1
19	PAF25-05000016	90464-07M05	ABRAZADERA	CLAMP	FASCETTA	COLLIER	1
20	REC93102-36M24	93102-36M24	RETÉN DE ACEITE	OIL SEAL	PARAOLIO	JOINT SPI	1
21	REC93210-46M16	93210-46M16	TÓRICA	O-RING	O-RING	JOINT TORIQUE	1
22	REC93311-636U6	93311-636U6	RODAMIENTO	BEARING	CUSCINETTO	ROULEMENT À BILLE	1
23	REC93306-306V1	93306-306V1	RODAMIENTO	BEARING	CUSCINETTO	ROULEMENT À BILLE	1
24	REC93102-30M23	93102-30M23	RETÉN DE ACEITE	OIL SEAL	PARAOLIO	JOINT SPI	1
25	REC93106-18M01	93106-18M01	RETÉN DE ACEITE	OIL SEAL	PARAOLIO	JOINT SPI	1
26	REC93210-65M50	93210-65M50	TÓRICA	O-RING	O-RING	JOINT TORIQUE	1
27	PAGB/T97.1-8	92995-06600	ARANDELA	WASHER	RONDELLA	RONDELLE	3
28	PAGB/T5783-M6X20	97095-06020	TORNILLO	BOLT	VITE	VIS	3
29	REC90201-20417	90201-20417	ARANDELA	WASHER	RONDELLA	RONDELLE	6
30	REC93603-18M09	93603-18M09	AGUJA DE RODAMIENTO	BEARING NEEDLE	SPILLO DE CUSCINETTO	CLAVETTE DE PALIER	84
31	REC688-11634-00	688-11634-10	CIRCLIP	CIRCLIP	CIRCLIP	CIRCLIP	6
32	REC6H3-11633-00	6H3-11633-00	PIN, PISTÓN	PIN, PISTON	SPINOTTO PISTONE	AXE DE PISTON	3
	REC6H3-11631-01K	6H3-11631-01-96	PISTÓN STD	PISTON STD	PISTONE STD	PISTON STD	
33	REC6H3-11635-01K	6H3-11635-01	PISTÓN 0.25mm O/S	PISTON 0.25mm O/S	PISTONE 0.25mm O/S	PISTON 0.25mm O/S	3
	REC6H3-11636-01K	6H3-11636-01	PISTÓN 0.50mm O/S	PISTON 0.50mm O/S	PISTONE 0.50mm O/S	PISTON 0.50mm O/S	
	REC6K5-11601-02	6K5-11601-02	KIT SEGMENTOS STD	PISTON RING SET STD	KIT FASCE STD	KIT SEGMENTS STD	
34	REC6K5-11601-12	6K5-11601-12	KIT SEGMENTOS DE PISTÓN 0.25mm O/S	PISTON RING SET 0.25mm O/S	KIT FASCE 0.25mm O/S	KIT SEGMENTS 0.25mm O/S	3
	REC6K5-11601-22	6K5-11601-22	KIT SEGMENTOS DE PISTÓN 0.50mm O/S	PISTON RING SET 0.50mm O/S	KIT FASCE 0.50mm O/S	KIT SEGMENTS 0.50mm O/S	
35	REC6H3-45113-00	6H3-45113-00	JUNTA BASE MOTOR	GASKET ENGINE	GUARNIZIONE BASE MOTORE	JOINT DE TETE MOTRICE	1

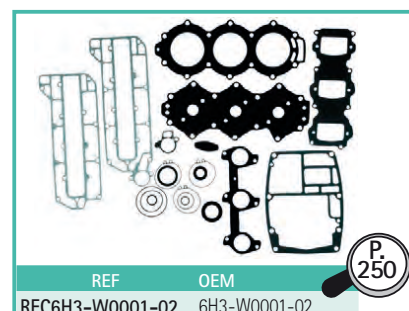
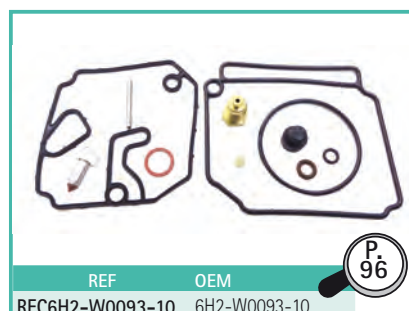



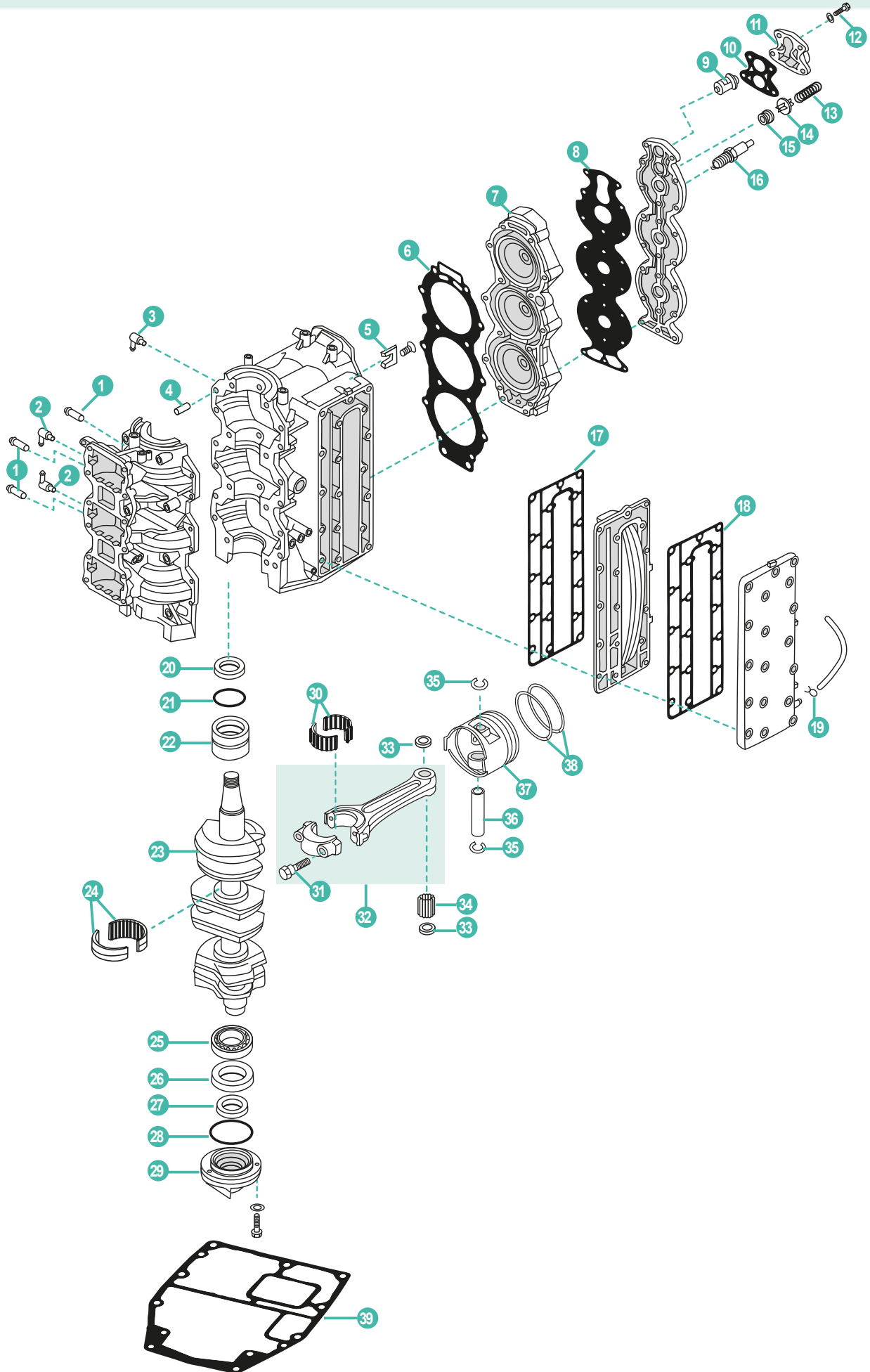

	REF	OEM				UN.	
1	REC624-14485-00	624-14485-00	PIPA DE AGUA	PIPE, WATER	TUBO	RACCORD TUYAU D'EAU	4
2	REC688-11370-00	688-11370-01	NIPLE DE MANGUERA	NIPPLE	TUBO	RACCORD D'EAU	2
3	REC650-11370-00	650-11370-01	NIPLE DE MANGUERA	NIPPLE	TUBO	RACCORD D'EAU	1
4	PAF25-00000014	93608-12063	PIN CENTRADOR	HOLLOW PIN	SPINOTTO DI CENTRAGGIO	PIN DE CENTRAGE	2
5	TEN01147	688-11325-00	ÁNODO	ANODE	ANODO	ANODE	2
6	REC688-11181-A1	688-11181-A1	JUNTA CULATA	GASKET, CYLINDER HEAD	GUARNIZIONE TESTATA	JOINT DE CULASSE	1
7	REC688-11111-02-1S	688-11111-02-1S	CULATA	CYLINDER HEAD	TESTATA	CULASSE	1
8	REC688-11193-A1	688-11193-A1	JUNTA TAPA	GASKET, COVER	GUARNIZIONE COPERCHIO	JOINT DE COUVRE CULASSE	1
9	REC6E5-12411-30	688-12411-10	TERMOSTATO	THERMOSTAT	TERMOSTATO	THERMOSTAT	1
10	REC688-12414-A1	688-12414-A1	JUNTA TAPA TERMOSTATO	GASKET, THERMOSTAT COVER	GUARNIZIONE COPERCHIO TERMOSTATO	JOINT COUVERCLE DE THERMOSTAT	1
11	REC688-12413-00-1S	688-12413-00-1S	TAPA TERMOSTATO	COVER, THERMOSTAT	COPERCHIO TERMOSTATO	COUVERCLE DE THERMOSTAT	1
12	PAGB/T5783-M6X35	90119-06MA5	TORNILLO	BOLT, WITH WASHER	VITE	VIS	4
13	REC90501-16M11	90501-16M11	MUELLE	SPRING COMPRESSION	MOLLA	RESSORT	1
14	REC688-12416-00	688-12416-00	VÁLVULA CONTROL DE PRESIÓN	VALVE, PRESSURE CONTROL	VALVOLA ANTIPRESSIONE	SOUPAPE DE DEPRESSION	1
15	REC90480-20M05	90480-20M05	JUNTA GOMA	GROMMET	GUARNIZIONE GOMMA	JOINT	1
16	NGKB8HS-10	90472-00247	BUJÍA	SPARK PLUG	CANDELA	BOUGIE	3
17	REC688-41112-A0	688-41112-A0	JUNTA DE ESCAPE	EXHAUST GASKET	GUARNIZIONE DI SCARICO	JOINT D'ECHAPPEMENT	1
18	REC688-41114-A0	688-41114-A0	JUNTA EXTERIOR, TAPA DE ESCAPE	GASKET, EXHAUST OUTER COVER	GUARNIZIONE ESTERIORE, COPERCHIO SCARICO	JOINT DE COUVERCLE EXT ECHAPPEMENT	1
19	PAF4-04000030	90467-08004	PRESILLA	CLAMP	CLIP	CLIP	1
20	REC93102-36M02	93102-36M02	RETÉN DE ACEITE	OIL SEAL	PARAOLIO	JOINT SPI	1
21	REC93210-46M16	93210-46M16	TÓRICA	O-RING	O-RING	JOINT TORIQUE	1
22	REC93310-636U4	93310-636U4	RODAMIENTO	BEARING	CUSCINETTO	PALIER	1
23	REC688-11411-00	688-11411-01	CIGÜEÑAL	CRANK ASSY	ALBERO MOTORE	VILEBREQUIN	1
24	REC93310-835U8	93310-835U8	RODAMIENTO	BEARING	CUSCINETTO	ROULEMENT À BILLE	2
25	REC93306-206U5	93306-206U5	RODAMIENTO	BEARING	CUSCINETTO	ROULEMENT À BILLE	1
26	REC93102-30M05	93102-30M05	RETÉN DE ACEITE	OIL SEAL	PARAOLIO	JOINT SPI	1
27	REC93104-20M02	93104-20M02	RETÉN DE ACEITE	OIL SEAL	PARAOLIO	JOINT SPI	1
28	REC93210-62269	93210-62269	TÓRICA	O-RING	O-RING	JOINT TORIQUE	1
29	REC6H1-15359-01-94	6H1-15359-01-94	CUERPO DEL RETÉN	SHELL, OIL SEAL	GUARNIZIONE CORPO	LOGEMENT JOINT D'HUILE	1
30	REC93310-730V8	93310-730V8	COJINETE DE BIELA	BEARING, CONNECTING ROD	CUSCINETTO BIELLA	PALIER DE BIELLE	3
31	REC90109-08022	90109-08022	TORNILLO	BOLT	VITE	VIS	2
32	REC688-11650-03	688-11650-03	BIELA	CONNECTING ROD ASSY	BEILLA	BIELLE	3
33	REC90201-20417	90201-20417	ARANDELA	WASHER PLATE	RONDELLA	RONDELLE	6
34	REC93603-21111	93603-21111	AGUJA DE RODAMIENTO	BEARING NEEDLE	SPILLO DE CUSCINETTO	CLAVETTE DE PALIER	84
35	REC688-11634-00	688-11634-00	CIRCLIP	CIRCLIP	CIRCLIP	CIRCLIP	6
36	REC663-11633-00	663-11633-00	PIN, PISTÓN	PIN, PISTON	SPINOTTO PISTONE	AXE DE PISTON	3
37	REC688-11631-03K	688-11631-03-94	PISTÓN STD	PISTON STD	PISTONE STD	PISTON STD	3
38	REC688-11603-A0	688-11603-A0	KIT SEGMENTOS STD	PISTON RING SET STD	KIT FASCE STD	KIT SEGMENTS STD	3
38	REC688-11605-A0	688-11605-A0	KIT SEGMENTOS DE PISTÓN 0.50mm O/S	PISTON RING SET 0.50mm O/S	KIT FASCE 0.50mm O/S	KIT SEGMENTS 0.50mm O/S	3
39	REC688-45113-A0	688-45113-A0	JUNTA BASE MOTOR	GASKET ENGINE	GUARNIZIONE BASE MOTORE	JOINT DE TETE MOTRICE	1

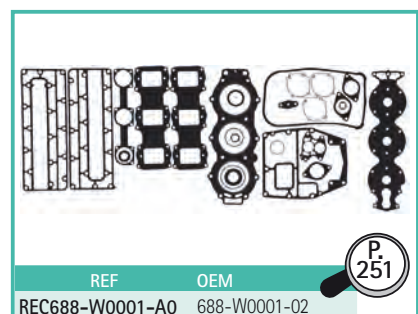

2T  
STROKES

100A/AETO • 100TLR • 115AEL/B/BETO/BE-TR/C/CEO/CETO • C115TLR • 130B/BETO • 130TLR/TLRZ • 140A • 140B

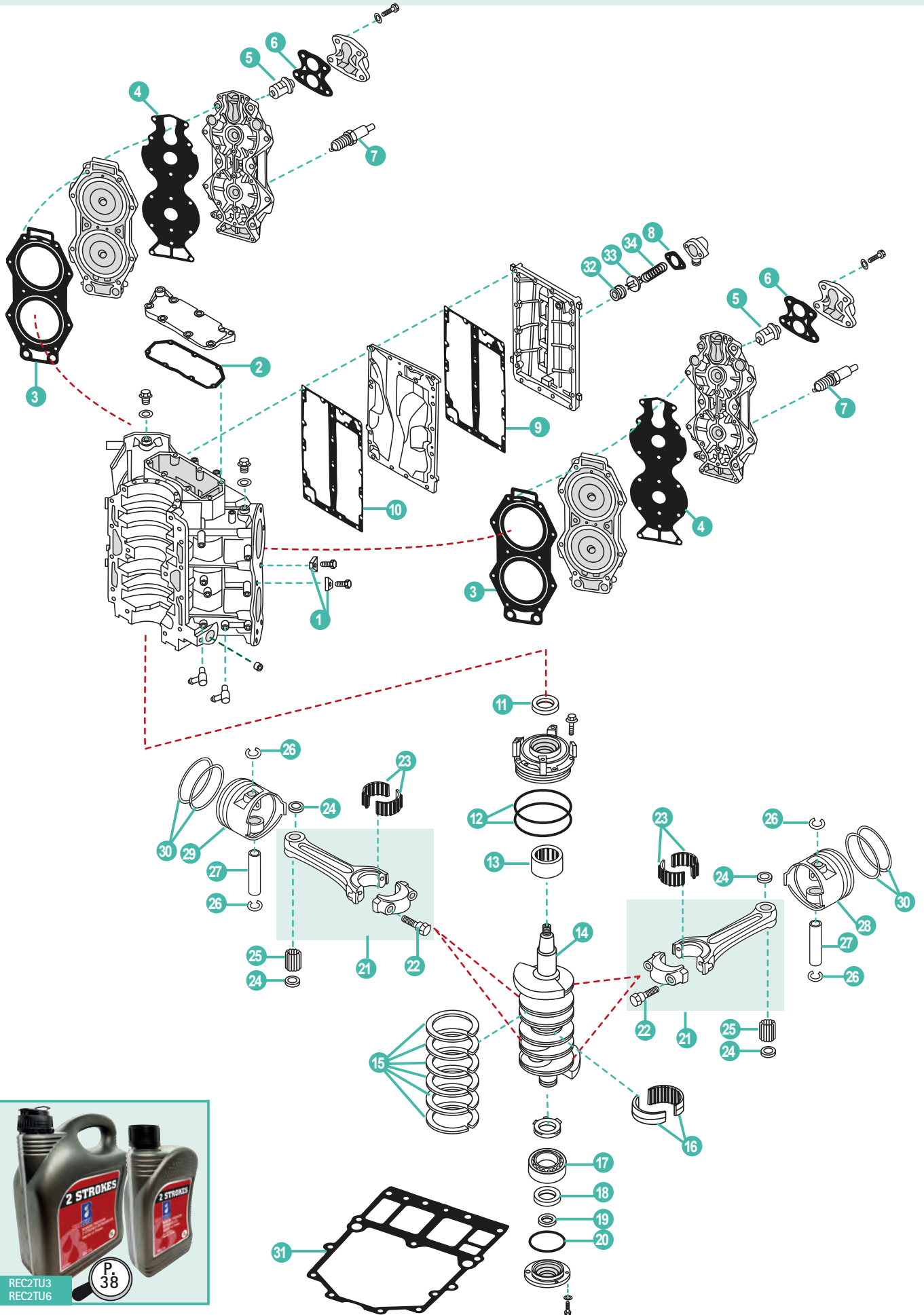

YAMAHA

RECAMBIOS  
MARINOS

	REF	OEM				UN.	
1	TEN01152	6E5-11325-00	ÁNODO	ANODE	ANODO	ANODE	4
2	REC6E5-11381-A1	6E5-11381-A2	JUNTA	GASKET	GUARNIZIONE	JOINT	1
3	REC6E5-11181-A0	6E5-11181-A2	JUNTA CULATA	GASKET, CYLINDER HEAD	GUARNIZIONE TESTATA	JOINT DE CULASSE	2
4	REC6E5-11193-A0	6E5-11193-A0	JUNTA CULATÍN	GASKET, HEAD COVER	GUARNIZIONE COPERCHIO TESTA	JOINT DE COUVRE CULASSE	2
5	REC6E5-12411-30	6E5-12411-30	TERMOSTATO	THERMOSTAT	TERMOSTATO	THERMOSTAT	2
6	REC688-12414-A1	688-12414-A1	JUNTA TAPA TERMOSTATO	GASKET, THERMOSTAT COVER	GUARNIZIONE COPERCHIO TERMOSTATO	JOINT COUVERCLE DE THERMOSTAT	2
7	NGKBR8HS-10	94702-00247	BUJÍA 100, 115	SPARK PLUG 100, 115	CANDELA 100, 115	BOUGIE 100, 115	4
	NGKBR9HS-10	94702-00309	BUJÍA 130	SPARK PLUG 130	CANDELA 130	BOUGIE 130	
8	REC6G5-11382-A1	6G5-11382-A1	JUNTA	GASKET	GUARNIZIONE	JOINT	1
9	REC6E5-41112-A1	6E5-41112-A1	JUNTA EXTERIOR, TAPA DE ESCAPE	GASKET, EXHAUST OUTER COVER	GUARNIZIONE ESTERIORE, COPERCHIO SCARICO	JOINT DE COUVERCLE EXT ECHAPPEMENT	1
10	REC6E5-41112-A1	6E5-41112-A1	JUNTA DE ESCAPE	EXHAUST GASKET	GUARNIZIONE DI SCARICO	JOINT D'ECHAPPEMENT	1
11	REC93102-40M14	93102-40M14	RETÉN DE ACEITE	OIL SEAL	PARAOLIO	JOINT SPI	1
12	REC93211-04001	93211-04001	TÓRICA	O-RING	O-RING	JOINT TORIQUE	2
13	REC93311-940U3	93311-940U3	RODAMIENTO	BALL BEARING	CUSCINETTO	ROULEMENT À BILLE	1
14	REC6N7-11411-00	6N7-11411-00	CIGÜEÑAL	CRANKSHAFT	ALBERO MOTORE	VILEBREQUIN	1
15	REC6E5-11447-00	6E5-11447-00	ARO	SEAL, CRANK	O-RING	JOINT TORIQUE	6
16	REC93310-954U1	93310-954U1	RODAMIENTO	BALL BEARING	CUSCINETTO	ROULEMENT À BILLE	1
17	REC93306-208U0	93306-208U0	RODAMIENTO	BALL BEARING	CUSCINETTO	ROULEMENT À BILLE	1
18	REC93102-35M13	93102-35M13	RETÉN DE ACEITE	OIL SEAL	PARAOLIO	JOINT SPI	1
19	REC93101-22M15	93101-22M15	RETÉN DE ACEITE	OIL SEAL	PARAOLIO	JOINT SPI	1
20	REC93210-74M35	93210-74M35	TÓRICA	O-RING	O-RING	JOINT TORIQUE	1
21	REC6R5-11650-10	6R5-116950-0	BIELA	CONNECTING ROD ASSY	BIELLA	BIELLE	4
22	REC90109-08M71	90109-08M71	TORNILLO	BOLT	VITE	VIS	8
23	REC93310-836V2	93310-836V2	COJINETE DE BIELA	BEARING, CONNECTING ROD	CUSCINETTO BIELLA	PALIER DE BIELLE	4
24	REC90201-23M01	90201-23M01	ARANDELA	WASHER	RONDELLA	RONDELLE	8
24	REC90201-21M75	90201-21M75	ARANDELA	WASHER	RONDELLA	RONDELLE	8
25	REC93310-32337	93310-323V6	AGUJA DE RODAMIENTO	BEARING NEEDLE	SPILLO DE CUSCINETTO	CLAVETTE DE PALIER	4
26	REC6R5-11634-00	6R5-11634-10	CIRCLIP	CIRCLIP	CIRCLIP	CIRCLIP	8
27	REC6R5-11633-00	6R5-11633-10	PIN, PISTÓN	PIN, PISTON	SPINOTTO PISTONE	AXE DE PISTON	4
28	REC6R5-11642-01K	6R5-11642-11-93	PISTÓN STD 2	PISTON STD 2	PISTONE STD 2	PISTON STD 2	2
29	REC6R5-11631-11K	6R5-11361-11-93	PISTÓN STD 1	PISTON STD 1	PISTONE STD 1	PISTON STD 1	2
	REC64D-11603-01	64D-11603-01	KIT SEGMENTOS DE PISTÓN STD	PISTON RING SET STD	KIT FASCE STD	KIT SEGMENTS STD	
30	REC64D-11604-01	64D-11604-01	KIT SEGMENTOS DE PISTÓN 0.25mm O/S	PISTON RING SET 0.25mm O/S	KIT FASCE 0.25mm O/S	KIT SEGMENTS 0.25mm O/S	4
	REC64D-11605-01	64D-11605-01	KIT SEGMENTOS DE PISTÓN 0.50mm O/S	PISTON RING SET 0.50mm O/S	KIT FASCE 0.50mm O/S	KIT SEGMENTS 0.50mm O/S	
31	REC6G5-45113-A1	6G5-45113-A1	JUNTA BASE MOTOR	GASKET ENGINE	GUARNIZIONE BASE MOTORE	JOINT DE TETE MOTRICE	1
32	REC90480-20M05	90480-20M05	JUNTA GOMA	GROMMET	GUARNIZIONE GOMMA	JOINT	1
33	REC60H-12416-00	60H-12416-00	VÁLVULA CONTROL DE PRESIÓN	VALVE, PRESSURE CONTROL	VALVOLA ANTIPRESSIONE	SOUPAPE DE DEPRESSION	1
34	REC90501-16M11	90501-16M11	MUELLE	SPRING COMPRESSION	MOLLA	RESSORT	1

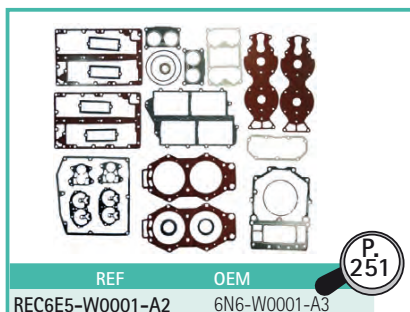



2T  
STROKES

150AET • 150F/FETO • 150L/SL150 • 150TR/150TXRA • D150H • 175D/DETO • S175 • L175 • 175D/DETO  
• S175 -L175 • 200AET • 200G/GETO • 200F/FETO • L200 • 200TLR • 225D/DET/DETO • L225A • L225B

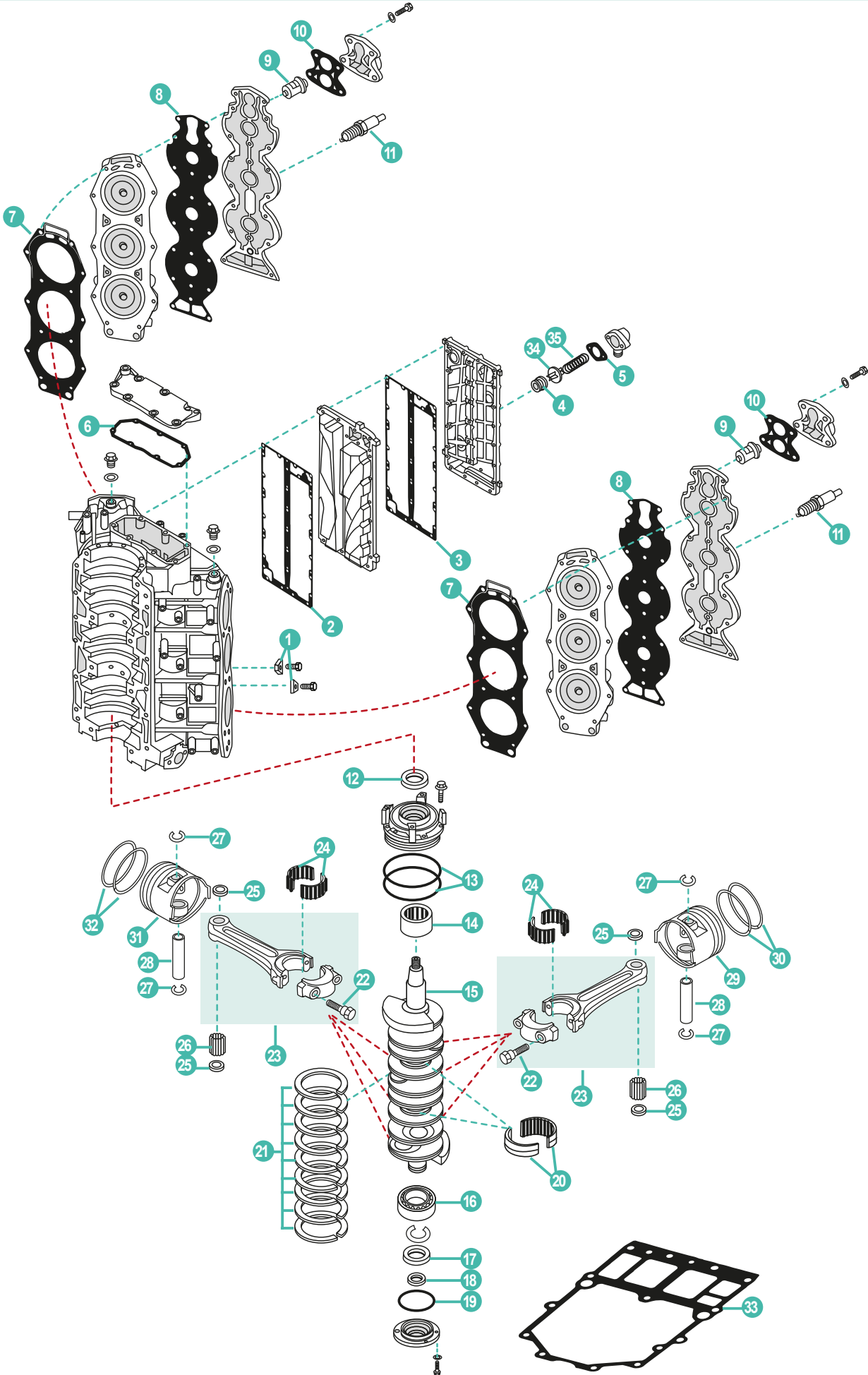

YAMAHA

RECAMBIOS  
MARINOS

	REF	OEM				UN.	
1	TEN01152	6E5-11325-00	ÁNODO	ANODE	ANODO	ANODE	8
2	REC6G5-41112-A1	6G5-41112-A1	JUNTA DE ESCAPE	EXHAUST GASKET	GUARNIZIONE DI SCARICO	JOINT D'ECHAPPEMENT	1
3	REC6G5-41114-A0	6G5-41114-A0	JUNTA EXTERIOR, TAPA DE ESCAPE	GASKET, EXHAUST OUTER COVER	GUARNIZIONE ESTERIORE, COPERCHIO SCARICO	JOINT DE COUVERCLE EXT ECHAPPEMENT	1
4	REC90480-20M05	90480-20M05	JUNTA DE GOMA	GROMMET	GUARNIZIONE GOMMA	JOINT	1
5	REC6G5-11382-A1	6G5-11382-A1	JUNTA	GASKET	GUARNIZIONE	JOINT	1
6	REC6E5-11381-A1	6E5-11381-A2	JUNTA	GASKET	GUARNIZIONE	JOINT	1
7	REC6G5-11181-A2	6G5-11181-A3	JUNTA CULATA	GASKET, CYLINDER HEAD	GUARNIZIONE TESTATA	JOINT DE CULASSE	2
8	REC6G5-11193-A0	6F5-11193-A0	JUNTA TAPA	GASKET, COVER	GUARNIZIONE COPERCHIO	JOINT DE COUVRE CULASSE	2
9	REC6E5-12411-30	6E5-12411-30	TERMOSTATO	THERMOSTAT	TERMOSTATO	THERMOSTAT	2
10	REC688-12414-A1	688-12414-A1	JUNTA TAPA TERMOSTATO	GASKET, THERMOSTAT COVER	GUARNIZIONE COPERCHIO TERMOSTATO	JOINT COUVERCLE DE THERMOSTAT	2
11	NGKBR8HS-10	94702-00271	BUJÍA	SPARK PLUG	CANDELA	BOUGIE	6
12	REC93102-40M14	93102-40M14	RETÉN DE ACEITE	OIL SEAL	PARAOLIO	JOINT SPI	1
13	REC93211-04001	93211-04001	TÓRICA	O-RING	O-RING	JOINT TORIQUE	2
14	REC93311-940U3	93311-940U3	RODAMIENTO	BEARING	CUSCINETTO	ROULEMENT À BILLE	1
	REC93311-940V0	93311-940V0	RODAMIENTO CIGÜEÑAL (6Do)	CRANKSHAFT BEARING (6Do)	CUSCINETTO ALBERO MOTORE (6Do)	ROULEMENT DE VILEBREQUIN (6Do)	1
15	REC6G5-11411-02	6G5-11411-02	CIGÜEÑAL	CRANKSHAFT	ALBERO MOTORE	VILEBREQUIN	1
16	REC93306-208U0	93306-208U0	RODAMIENTO	BEARING	CUSCINETTO	ROULEMENT	1
17	REC93102-35M13	93102-35M13	RETÉN DE ACEITE	OIL SEAL	PARAOLIO	JOINT SPI	1
18	REC93101-22M15	93101-22M15	RETÉN DE ACEITE	OIL SEAL	PARAOLIO	JOINT SPI	1
19	REC93210-74M35	93210-74M35	TÓRICA	O-RING	O-RING	JOINT TORIQUE	1
20	REC93310-954U1	93310-954U1	RODAMIENTO	BEARING	CUSCINETTO	ROULEMENT À BILLE	1
	REC93310-959U0	93310-959U0	RODAMIENTO CIGÜEÑAL (6Do)	CRANKSHAFT BEARING (6Do)	CUSCINETTO ALBERO MOTORE (6Do)	ROULEMENT DE VILEBREQUIN (6Do)	1
21	REC6E5-11447-00	6E5-11447-00	ARILLO	SEAL, CRANK	O-RING	JOINT	9
22	REC90109-08022	90109-08022	TORNILLO	BOLT	VITE	VIS	2
23	REC6R5-11650-10	6F5-11650-11	BIELA	CONNECTING ROD ASSY	BIELLA	BIELLE	6
24	REC93310-836V2	93310-836V2	COJINETE DE BIELA	BEARING, CONNECTING ROD	CUSCINETTO BIELLA	PALIER DE BIELLE	6
25	REC90201-23M01	90201-23M01	ARANDELA	WASHER PLATE	RONDELLA	RONDELLE	12
	REC90201-21M75	90201-21M75	ARANDELA (61A)	WASHER (61A)	RONDELLA (61A)	RONDELLE (61A)	12
26	REC93310-32337	93310-32337	AGUJA DE RODAMIENTO	BEARING NEEDLE	SPILLO DE CUSCINETTO	CLAVETTE DE PALIER	6
	REC93310-32668	93310-32668	AGUJA DE RODAMIENTO (250G)	BEARING NEEDLE (250G)	SPILLO DE CUSCINETTO (250G)	CLAVETTE DE PALIER (250G)	6
27	REC6R5-11634-00	6R5-11634-10	CIRCLIP	CIRCLIP	CIRCLIP	CIRCLIP	12
28	REC6R5-11633-00	6R5-11633-10	PIN, PISTÓN	PIN, PISTON	SPINOTTO PISTONE	AXE DE PISTON	6
29	REC64D-11642-00K	64D-11642-02-90	PISTON STD 2	PISTON STD 2	PISTONE STD 2	PISTON STD 2	3
	REC64D-11603-01	64D-11603-02	KIT SEGMENTOS DE PISTÓN STD	PISTON RING SET STD	KIT FASCE STD	KIT SEGMENTS STD	3
30	REC64D-11604-01	64D-11604-01	KIT SEGMENTOS DE PISTÓN 0.25mm O/S	PISTON RING SET 0.25mm O/S	KIT FASCE 0.25mm O/S	KIT SEGMENTS 0.25mm O/S	3
	REC64D-11605-01	64D-11605-02	KIT SEGMENTOS DE PISTÓN 0.50mm O/S	PISTON RING SET 0.50mm O/S	KIT FASCE 0.50mm O/S	KIT SEGMENTS 0.50mm O/S	3
31	REC64D-11631-00K	64D-11631-02-90	PISTON STD 1	PISTON STD 1	PISTONE STD 1	PISTON STD 1	3
	REC64D-11603-01	64D-11603-02	KIT SEGMENTOS DE PISTÓN STD	PISTON RING SET STD	KIT FASCE STD	KIT SEGMENTS STD	3
32	REC64D-11604-01	64D-11604-02	KIT SEGMENTOS DE PISTÓN 0.25mm O/S	PISTON RING SET 0.25mm O/S	KIT FASCE 0.25mm O/S	KIT SEGMENTS 0.25mm O/S	3
	REC64D-11605-01	64D-11605-02	KIT SEGMENTOS DE PISTÓN 0.50mm O/S	PISTON RING SET 0.50mm O/S	KIT FASCE 0.50mm O/S	KIT SEGMENTS 0.50mm O/S	3
33	REC6G5-45113-A1	6G5-45113-A1	JUNTA BASE MOTOR	GASKET ENGINE	GUARNIZIONE BASE MOTORE	JOINT DE TETE MOTRICE	1
34	REC60H-12416-00	60H-12416-00	VÁLVULA CONTROL DE PRESIÓN	VALVE, PRESSURE CONTROL	VALVOLA ANTIPRESSIONE	SOUPAPE DE DEPRESSION	1
35	REC90501-16M11	90501-16M11	MUELLE	SPRING COMPRESSION	MOLLA	RESSORT	1

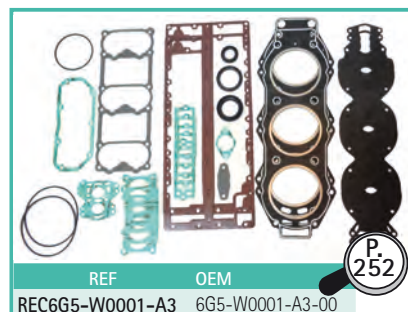

JUNTAS DE MOTOR  
2 TIEMPOS

ENGINE GASKET  
2 STROKES

GUARNIZIONI  
MOTORE 2 TEMPI

JOINTS DE MOTEUR  
2 TEMPS

2T  
STROKES

JUNTAS DE CULATA

CYLINDER HEAD GASKET

GUARNIZIONE DE TESTATA

JOINT DE CULASSE

REF	OEM
REC6F8-11181-A0	6F8-11181-A1

2CMH (2003+)

**P. 220**



REF	OEM
REC6H4-11181-00	6H4-11181-A2

25Q  
40N/H  
50E/D (1984-94)



REF	OEM
REC677-11181-A0	677-11181-A1

E8D/DMH (1997-03)

**P. 225**



REF	OEM
REC61N-11181-00	61N-11181-A2

25VE/VM  
E25A/BMH  
30G  
E30HMH/H (1996-12)



REF	OEM
REC63V-11181-A1	63V-11181-A1

9.9F/MH/MSH  
E9.9D  
15F/FMH/MSH  
E15D  
13.5 AWH/AMH (1995+)

**P. 227**



REF	OEM
REC689-11181-00	689-11181-A2

30A (1990-92)



REF	OEM
REC6E7-11181-00	6E7-11181-A2

9.9D  
15D (1988-96)



REF	OEM
REC6J8-11181-A2	6J8-11181-A2

30D  
25J (1986+)

**P. 231**



REF	OEM
REC6L2-11181-A1	6L2-11181-A3

20D/M  
25D/M/N (1988+)



REF	OEM
REC6F5-11181-A2	6F5-11181-A2

40GWH/JWH  
E40GMH/JMH (2003)

**P. 235**



REF	OEM
REC695-11181-00	695-11181-A1

20C  
25D (1986-02)



REF	OEM
REC63D-11181-A1	63D-11181-A2

40V  
C40/EL/TLR/Y  
50H/TLR/TR  
(1995+)

**P. 237**

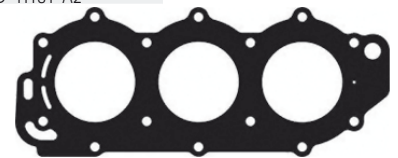

REF	OEM
REC6H3-11181-A0	6H3-11181-A2

25B  
50G  
60T  
E60  
60FE  
70B/ET/CE (1984+)

**P. 241**



REF	OEM
REC6R7-11181-A0	6R7-11181-A1

40G (1993)





REF	OEM
REC676-11181-01	676-11181-A2

40QE/QM/QWC (1990-98)

REF	OEM
REC6G5-11181-A2	6G5-11181-A3

150A/E/C/AET  
175AET/B/D  
200AET/B/C/FETGE  
225AET/BETO/D

REF	OEM
REC66T-11181-00	66T-11181-A0

40X  
E40X/M (1998-09)

REF	OEM
REC60V-11181-00	60V-11181-00

Z250  
VZ250  
LZ250 (2003-07)

REF	OEM
REC697-11181-A1	697-11181-A2

E55CMH  
E48CMH  
55BET  
55B/BE/BM (1990-05)

REF	OEM
REC68F-11181-00	68F-11181-00

Z/VZ/LZ200 (2001-07)  
Z/VZ/LZ150 (2000-07)  
Z/VZ175 (2001-07)

REF	OEM
REC688-11181-A1	688-11181-A2

75A/AE/CET  
80A/AE  
85A/AE  
90A/AE/TR (1986-14)

REF	OEM
REC6D0-11181-00	6D0-11181-00

VZ/LZ/Z300 (2004-07)

REF	OEM
REC6E5-11181-A0	6E5-11181-A2

100A  
115A/E/B/C  
C115T 130B  
140A (1984+)

REF	OEM
REC61A-11181-A0	69L-11181-00

225G/F (1194-03)  
250A/B/F (1992-06)

2T  
STROKES

**KITS**  
**JUNTAS DE CULATA**

**CYLINDER HEAD GASKET  
KIT**

REF	OEM
REC63V-W0001-00	63V-W0001-01

9.9-15F/FMH/FEMH/MSH (1995-00)  
13.5AWH (1998)

**KIT**  
**GUARNIZIONE TESTATA**

**KITS**  
**JOINT DE CULASSE**

REF	OEM
REC6E7-W0001-A1	6E7-W0001-00 6E7-W0001-A1

9.9D  
15D



REF	OEM
REC61T-W0001-02	61T-W0001-02

 E25A, 25VM, 30G/GE/A

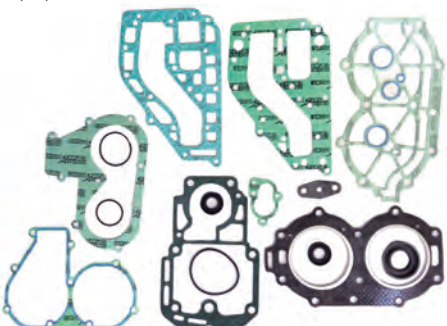

REF	OEM
REC695-W0001-A2	695-W0001-01

 25D/DE (1985-92)  
20CM/C (1985-92)

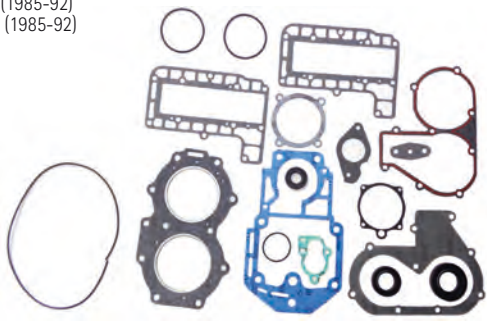

REF	OEM
REC6H3-W0001-02	6H3-W0001-02

 25B/BETO (1994-95)  
50G/GEO/GETOL (1994-98)  
60FEO/FETO/FEDO/TLR/FEHTO/TR (1994-2007)

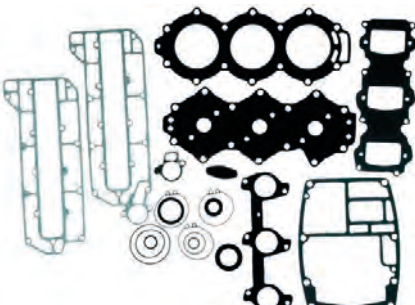

REF	OEM
REC6R6-W0001-02-00	6R6-W0001-02

 40QE-2 (1995-97)  
40QM (1996)  
40QWC (1998)

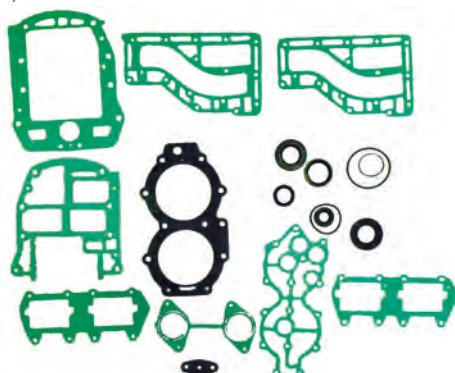

REF	OEM
REC6H4-W0001-04	6H4-W0001-04

 25QEO (1992-94)  
40HE (1992-94)  
50DE/DEMTO (1992-94)

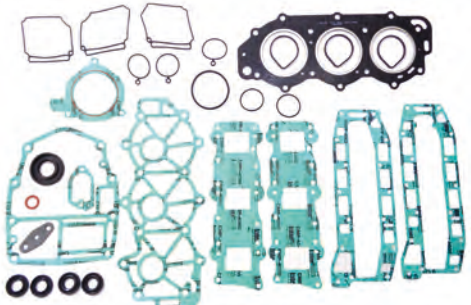

REF	OEM
REC66T-W0001-01	66T-W0001-01

 E40X/XMH/XW/  
MLHZ (2001-13)

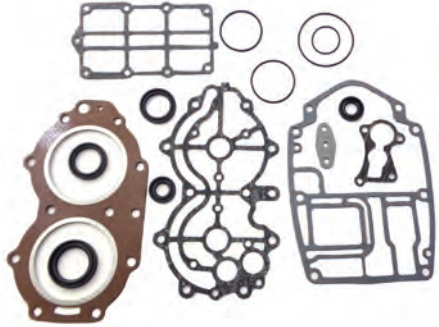

REF	OEM
REC6L2-W0001-03	6L2-W0001-A2

 25NE (1988-93)  
20DM (1988-93)  
25NEMO (1991-92)  
20D/DEO (1989-92)

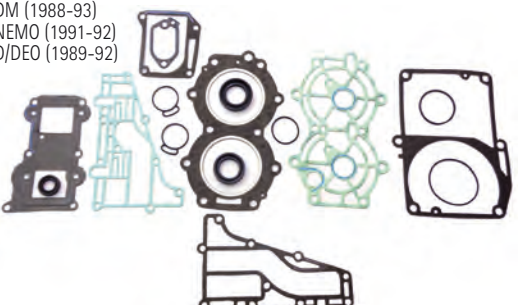

REF	OEM
REC6H4-W0001-A1	6H4-W0001-01

 40N (1984)  
40H (1985-98)  
50D (1985-98)  
50ETN (1984)

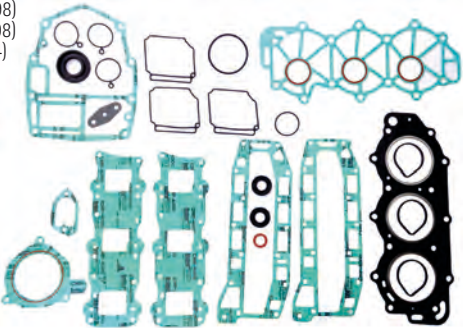

REF	OEM
REC6F6-W0001-02	6F6-W0001-02

**new**

 E40GMH/S/L  
 E40JMH  
 E40JWH  
 40GWH  
 40JWH

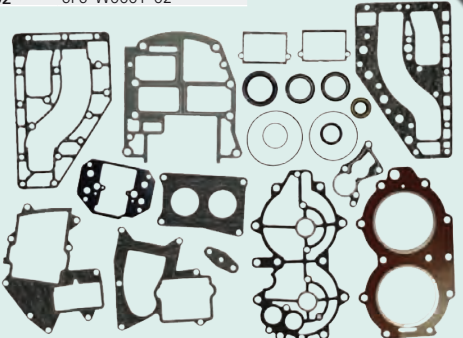

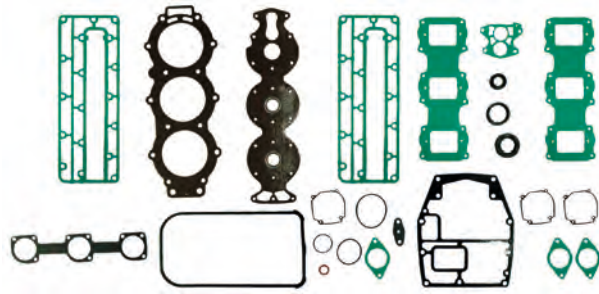

REF	OEM
REC688-W0001-A0	688-W0001-A0

 75A/AE (1990-91)  
 85A/AE (1990-91)



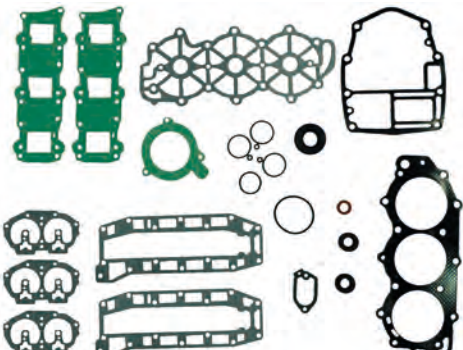

REF	OEM
REC63D-W0001-00	63D-W0001-00

 50H/HRDO/HMDH/HETO (1995-03)  
 40V/MMH/VETO/MLH/MHO/VE/VEO (1995-13)  
 40VEMHD/TLRZ/YETO (1997-07)  
 C40T/TLR (1995-02)



REF	OEM
REC6H1-W0001-00-00	6H1-W0001-A1

 80A/AE (1984-91)  
 80AEO (1992-93)  
 90A/AEO/AETO/ETN (1984-91)  
 90AEO (1992)

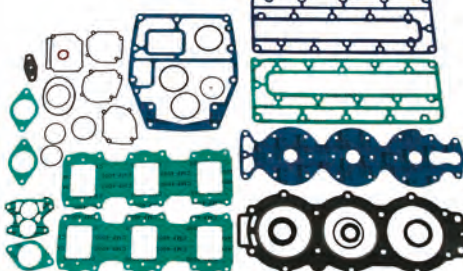

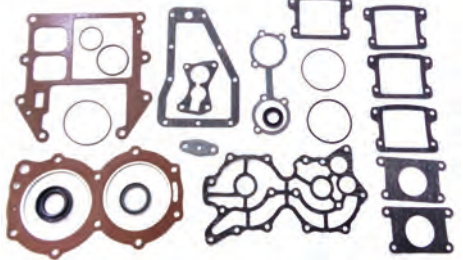

REF	OEM
REC697-W0001-02	697-W0001-A0

 55BET (1990)



REF	OEM
REC6E5-W0001-A2	6E5-W0001-A2

 L130BETO (1991-99)  
 115CEO/CETO (1991-96)  
 100A/AETO/TLR (1996-00)

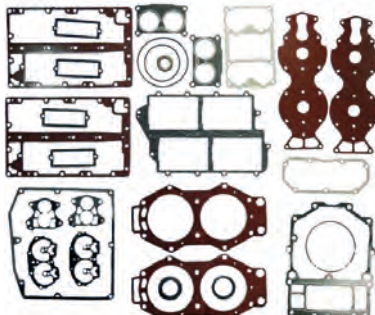

REF	OEM
REC6K5-W0001-02	6K5-W0001-02

 E60H/MHZ/HE/HM (1996-02)

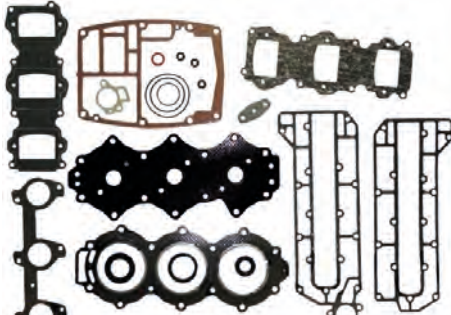

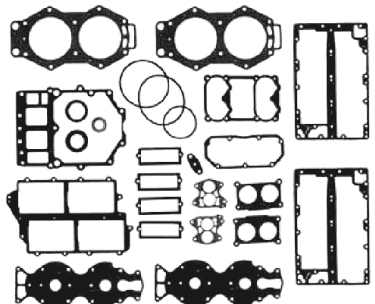

REF	OEM
REC6F3-W0001-04-00	6F3-W0001-A4

 115BETO (1991-93)  
 115B (1988-00)  
 115ETN (1984)  
 115A (1987)  
 140AETO/BETO (1984-89)  
 115BE (1992)





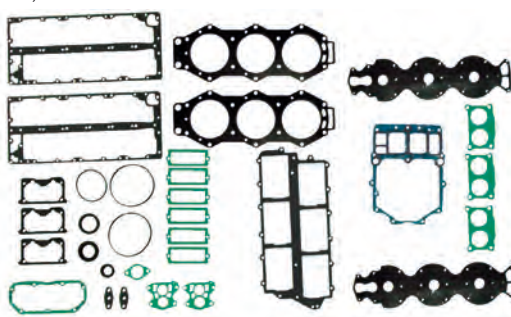

REF	OEM
REC6R3-W0001-03	6R3-W0001-A3

 L/150 CETO (1990-95)  
 L/200 BETO (1993-95)  
 175BETO/ET (1990-95)  
 L200ETD (1990)  
 150CED/ETD (1990)  
 200ET (1990)



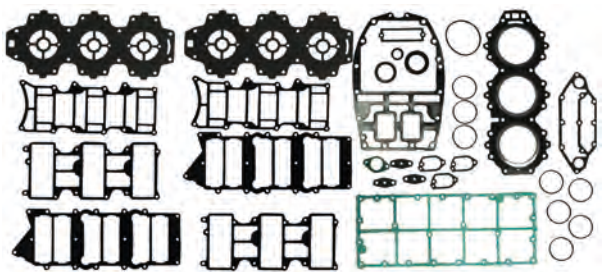

REF	OEM
REC61A-W0001-01	61A-W0001-A1

 250ETD (1990)  
 250AETO/AET/B (1990-96)  
 L250A/AET/AETO (1992-96)  
 225C (1994-95)  
 L225CETO (1994)



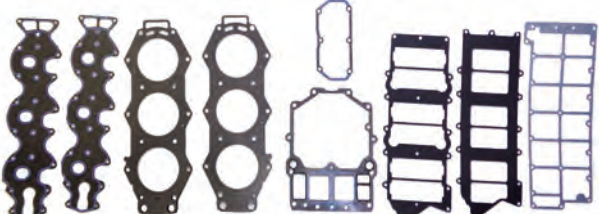

REF	OEM
REC68F-W0001-01	68F-W0001-01

 LZ200 (2004-10)  
 VZ200 (2004)  
 Z200 (2004-10)  
 Z  
 VZ200TLRC/PETO/TLR2D/PETOL/TXRC/  
 NETO-L/TR/NETOX/Z175GETO/GETOX/TR/TXR (2004-07)



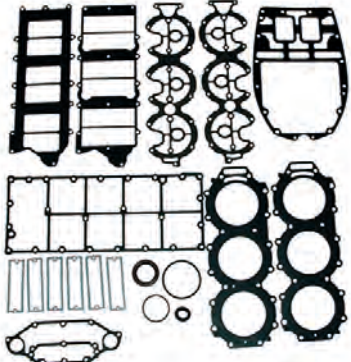

REF	OEM
REC6D0-W0001-00	6D0-W0001-00

 Z300AETO/TR  
 LZ300AETO/TR (2004-07)



REF	OEM
REC6G5-W0001-A3	6G5-W0001-03

 200CETO (1992-93)  
 PROV200 (1991-94)  
 225BET/BETO (1991-95)  
 150A/AETO/AETL/AETX (1998-02)

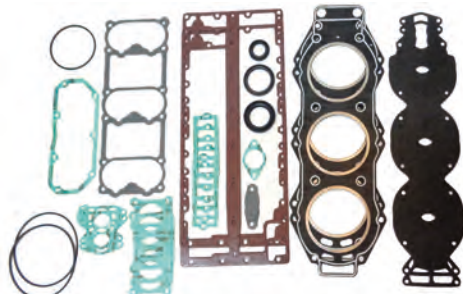

2T  
STROKES

JUNTAS BASE DE MOTOR    CYLINDER GASKET

GUARNIZIONE BASE MOTORE    JOINTS DE TETE MOTRICE

REF	OEM
REC6E0-45113-A1	6E0-45113-A1

 4A/AC/AS/MSH  
 5C/CS/CMH

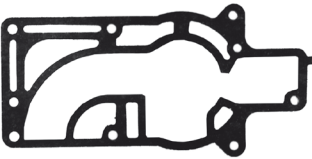

REF	OEM
REC6G1-45113-A1	6G1-45113-A1

 8N/C/J/T/M  
 6C/J/D/T/M



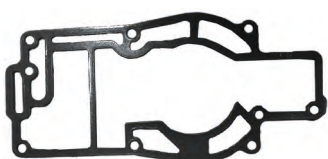

REF	OEM
REC677-45113-A0	677-45113-A0

 E8D/DMH





REF	OEM
REC6B4-11351-A1	6B4-11351-A1

 9.9/15 HP D 6B3-6B4 (2003)





new

REF	OEM
REC63V-45113-A1	63V-45113-A1
	9.9FEM/F/MSH/FMH/MH 13.5 AW/AMH 15F/FEM/MSH/FMH/MH

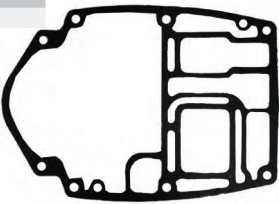

REF	OEM
REC66T-45113-A0	66T-45113-A0
	40X/E40X



REF	OEM
REC682-11351-A0	682-11351-A0
	9.9D 15D

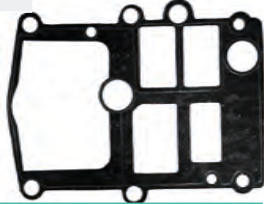

REF	OEM
REC696-45113-00	696-45113-A0
	55B/E55 E48

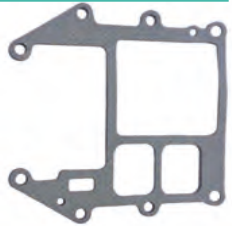

REF	OEM
REC6L2-45113-A2	6L2-45113-A1
	20D 25D/N/M

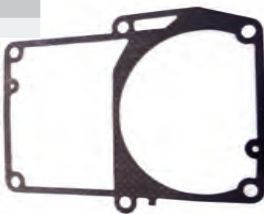

REF	OEM
REC6H3-45113-00	6H3-45113-A0
	60FE/TLR/F, 50G/GE E60H 70B/BE/CE/TR

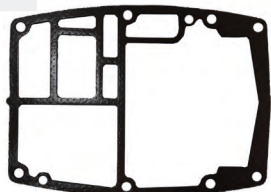

REF	OEM
REC61T-45113-A0	61T-45113-A0
	25VE/BMH 30G/HW

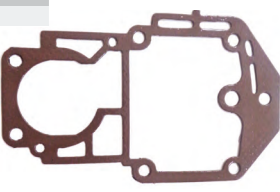

REF	OEM
REC688-45113-A0	688-45113-A0
	75A/AE/CE/TL 85A/AE 80A/AE 90A/AE/ETN

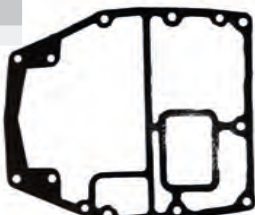

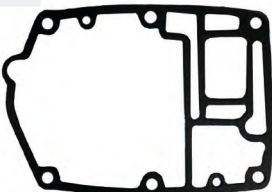

REF	OEM
REC6J8-45113-00	6J8-45113-A0
	25J 30D/DMH/DE/E/M

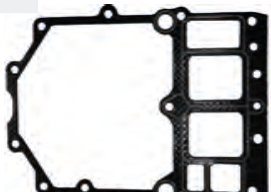

REF	OEM
REC6G5-45113-A1	6G5-45113-A2
	115ETN/A/B 130BE 150ETN/AET/CET/F/TXR/G 140AET/BET 175AET/BET/DE 150BET 200ETN/AET/CET/BET/AF/G 220AET 225AET/BET/D



REF	OEM
REC6H4-45113-00	6H4-45113-A0
	25Q 40N/H/E/M/T/Y 50D/H/T



REF	OEM
REC6E5-45113-A2	6E5-45113-A0
	115B/ET 140AE/BE

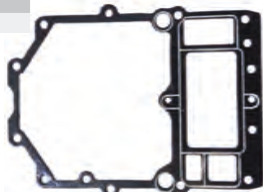

REF	OEM
REC6F5-45113-A0	6F5-45113-A0
	E40G/E40J/40G/40J/40Q

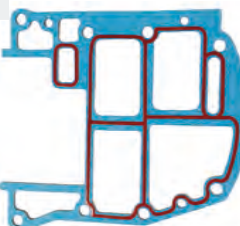

REF	OEM
REC68F-45113-01	68F-45113-01
	Z/VZ150 Z/VZ175 VZ-Z200/200A/F/J 150F/A Z200

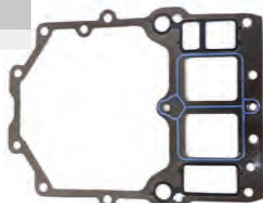



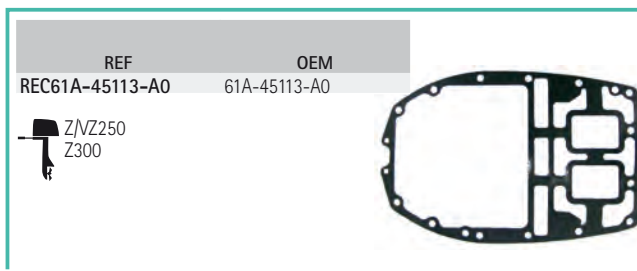
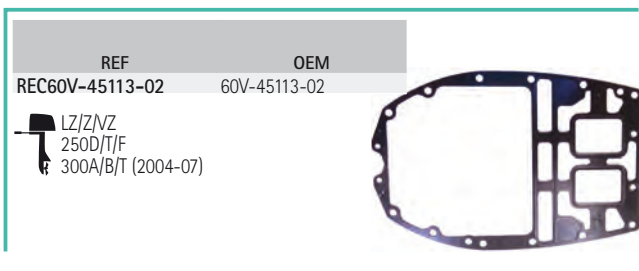

2T  
STROKES

GUÍA JUNTAS DE MOTOR		ENGINE GASKET GUIDE	GUIDA GUARNIZIONE MOTORE	GUIDE JOINTS DE MOTEURS
🔧	CYL	JUNTA CULATA CYLINDER HEAD GASKET GUARNIZIONE TESTAT JOINT DE CULASSE		KIT JOINTS
		JUNTA BASE MOTOR CYLINDER GASKET GUARNIZIONE BASE MOTORE JOINT DE TETE MOTRICE		
2CMH	2010	1	REC6F8-11181-A0	REC646-14623-A1
E8D/DMH	1997-03	2	REC677-11181-A0	REC677-45113-A0
9.9D	1988-96	2	REC6E7-11181-00	REC682-45113-A0
9.9F/FM/MSH/E9.9D	1995	2	REC63V-11181-A1	REC63V-45113-A1
13.5AWH/AMH	1995	2	REC63V-11181-A1	REC63V-45113-A1
15D	1988-95	2	REC6E7-11181-00	REC682-45113-A0
15F/FMH/MSH/E15D	1995	2	REC63V-11181-A1	REC63V-45113-A1
20C	1986-02	2	REC695-11181-00	REC61T-45113-A0
20D/20DM	1988	2	REC6L2-11181-A1	REC6L2-45113-A2
25DE/M/N	1998	2	REC6L2-11181-A1	REC6L2-45113-A2
25DE/M/N	1986-02	2	REC695-11181-00	REC61T-45113-A0
25VE/VM/BMH/E25A	1996-12	2	REC61N-11181-00	REC61T-45113-A0
25Q/QEO	1990-94	3	REC6H4-11181-00	REC6H4-45113-00
25J/JEO/JETO	1987-99	3	REC6J8-11181-A2	REC6J8-45113-00
25B/BETO	1994-95	3	REC6H3-11181-A0	REC6H3-45113-00
25B/BMH	1996-10	2	REC61N-11181-00	REC61T-45113-A0
30A	1990-92	2	REC689-11181-00	REC61T-45113-A0
30G/E30HMH/H	1996-12	2	REC61N-11181-00	REC61T-45113-A0
30D	1986	3	REC6J8-11181-A2	REC6J8-45113-00
40QE/QM/QWC	1990-98	2	REC676-11181-01	REC6R6-W0001-02-00
40N/H	1984-94	3	REC6H4-11181-00	REC6H4-W0001-A1
40G	1993	2	REC6R7-11181-A0	REC6R6-W0001-02-00
40X/E40/M/X	1998	2	REC66T-11181-00	REC66T-W0001-01
40/E40GMH/JMH	2003	2	REC6F5-11181-A2	REC6F5-45113-A0
40V/C40/EL/TLR/Y-YE	1995	3	REC63D-11181-A1	REC63D-W0001-00
E48	2003	2	REC697-11181-A1	REC697-W0001-02
50H/TLR/TR	1995	3	REC63D-11181-A1	REC63D-W0001-00
50G/GEO/GETO	1993-02	3	REC6H3-11181-A0	REC6H3-W0001-02
50E/D	1984-94	3	REC6H4-11181-00	REC6H4-W0001-A1
55B/E55	1990-05	2	REC697-11181-A1	REC697-W0001-02
60FE/T/E60	1984	3	REC6H3-11181-A0	REC6H3-W0001-02
70B/ET/CE	1984	3	REC6H3-11181-A0	REC6H3-W0001-02
70A/AE/CET	1986	3	REC688-11181-A1	REC688-W0001-A0
80A/AE	1986	3	REC688-11181-A1	REC688-W0001-A0
85A/AE	1986	3	REC688-11181-A1	REC688-W0001-A0
90A/AE/TR	1986	3	REC688-11181-A1	REC688-W0001-A0
100A	1984	4	REC6E5-11181-A0	REC6E5-W0001-A2
115A/B/E/C/C115T	1984	4	REC6E5-11181-A0	REC6E5-W0001-A2
130B	1984	4	REC6E5-11181-A0	REC6E5-W0001-A2
140A	1984	4	REC6E5-11181-A0	REC6E5-W0001-A2
LZ150/NZ150/Z150	2004-05	6	REC68F-11181-00	REC68F-W0001-01
150A/E/C/FET	1984-10	6	REC6G5-11181-A2	REC6G5-W0001-A3
VZ175/Z175	2004-10	6	REC68F-11181-00	REC68F-W0001-01
175D/B/AET	1984-10	6	REC6G5-11181-A2	REC6G5-W0001-A3
LZ200/NZ200/Z200	2004-10	6	REC68F-11181-00	REC68F-W0001-01
200B/C/AET/GE/FET	1984	6	REC6G5-11181-A2	REC6G5-W0001-A3
225D/BET/AET	1984	6	REC6G5-11181-A2	REC6G5-W0001-A3
225C/G	1990	6	REC61A-11181-A0	REC61A-W0001-01
250A/E/B	1990-06	6	REC61A-11181-A0	REC61A-W0001-01
Z-LZ250DET/TUR/TR	2003-07	6	REC60V-11181-00	REC60V-45113-02
250TR/FET/HETO	2003-07	6	REC60V-11181-00	REC60V-45113-02
V250TLR/TR	2003	6	REC60V-11181-00	REC60V-45113-02
Z-LZ300	2004-07	6	REC6D0-11181-00	REC6D0-W0001-00

JUNTAS DE CULATÍN

GASKET, HEAD COVER

GUARNIZIONI COPERCHIO  
TESTATA

JOINT DE COUVRE CULASSE

REF	OEM
REC6L2-11193-A1	6L2-11193-A1
	20D/DM/DEO 25NE/NEMO/NWC/ MSH



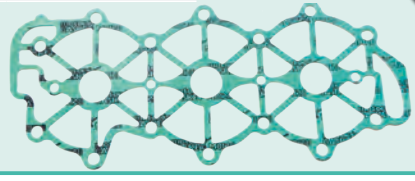

REF	OEM
REC63D-11193-A0	63D-11193-A0
	50H/T (1995+) 40V/M/Y (1995+)





**new**

REF	OEM
REC6H3-11193-A1	6H3-11193-A1
	25B/BETO 50G/GEO/GETO 60FEO/FETO/FEDO/TLR E60H/ HMH/MLH 70B//BEO/BEMO/BETO/TR





REF	OEM
REC688-11193-A1	688-11193-A1
	75CETO/TLR/AE E75B 80AEO/AETO/A 85A/AE 90AEO/TLR/A/AETO

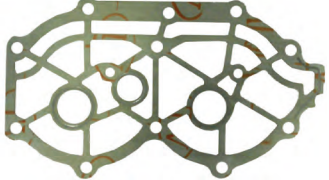

REF	OEM
REC61T-11193-A0	61T-11193-A1
	25VE/VM/BMH/B E25A/BMH 30G/GE/HMH/HW MSH



REF	OEM
REC6E5-11193-A0	6E5-11193-A0
	100A/AETO/TLR 115B/BETO/BE C115TLR/CEO/CETO/TXR E115AEL 130BETO



REF	OEM
REC66T-11193-A0	66T-11193-A0
	40X/E40X E40 MLH/X/XW

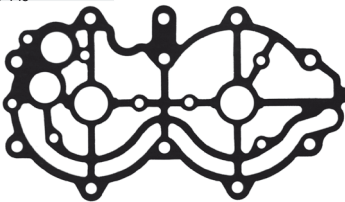



REF	OEM
REC68F-11193-02	68F-11193-02
	Z150P/TXR/PETO/TR/Q/QETO Z175G/GETO/TR/TXR/H Z200N/TXR/PETO/TLR/NETO

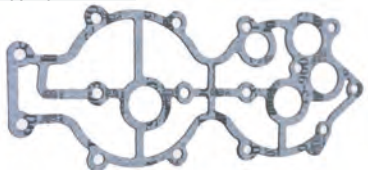

REF	OEM
REC6E9-11193-A0	6E9-11193-A0
	40QE/QE-Z/QM/QWC





REF	OEM
REC6G5-11193-A0	6G5-11193-A1
	150A/AET/CETO/F/FETO/TXR D150H 175D/DETO/BETO 200AET/CETO/FETO/G/GETO/BETO/TXR/F/TLR, 225D/DET/BET

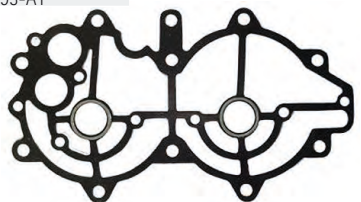

REF	OEM
REC6F6-11193-A1	6F6-11193-A1
	40GWH/JWH E40GMH/JMH



REF	OEM
REC61A-11193-A2	61A-11193-A2
	225C/CETO/G/GETO 250AET/B/TXR



REF	OEM
REC663-11193-00	663-11193-A0
	E48CMH 55BET/B/BE/BM/BET E55CMH

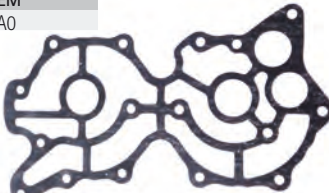

REF	OEM
REC6H4-11193-A1	6H4-11193-00
	25Q (1990-94) 40N/H (1984-91) 50E/D (1984-94)

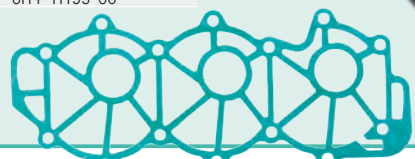

**new**

CIGÜEÑAL

CRANKSHAFT

ALBERO MOTORE

VILEBREQUIN

2T STROKES			2T STROKES			2T STROKES			2T STROKES		
GUÍA CIGÜEÑAL COMPLETO			GUIDE CRANKSHAFT ASSY			GUIDA ALBERO MOTORE COMPLETO			GUIDE VILEBREQUIN COMPLET		
2T STROKES			REF	2T STROKES			REF	2T STROKES			REF
E48CMHS	2003	REC663-11411-00	140A	1984-87	REC6E5-11411-00	175D ETO	2000	REC6G5-11411-02			
E55CMH/L/S	2003-05	REC663-11411-00	140B	1988-89	REC6E5-11411-00	175D ETOX	2001-02	REC6G5-11411-02			
55B	1993-02	REC663-11411-00	L140B	1989	REC6E5-11411-00	200A	1984-89	REC6G5-11411-02			
55B E	1990-92	REC663-11411-00	150A	1984-89	REC6G5-11411-02	200AET-L-X	2003	REC6G5-11411-02			
55B EHD	2000	REC663-11411-00	150A ET	1998-00	REC6G5-11411-02	200BETO/ETD	1990-95	REC6R3-11411-00			
55B ET	1990-98	REC663-11411-00	150A ETL/ETX	2001	REC6G5-11411-02	200CETO	1992-93	REC6R3-11411-00			
55B ETL	2001-02	REC663-11411-00	150D ETOL	2001-03	REC6G5-11411-02	200F	1997-98	REC6G5-11411-02			
80A/90AETO	1988	REC688-11411-00	150F	1997-98	REC6G5-11411-02	200F ETO	2000	REC6G5-11411-02			
100A	1996-01	REC6N7-11411-00	150F ETO	2000	REC6G5-11411-02	200F ETOL	2001	REC6G5-11411-02			
100A A ETO	2000	REC6N7-11411-00	150FETOL-X	2002-07	REC6G5-11411-02	200FETOL-X	2002-10	REC6G5-11411-02			
100A ETOL	2001	REC6N7-11411-00	150F ETOL	2001-06	REC6G5-11411-02	200F ETOX	2001	REC6G5-11411-02			
115A	1984-87	REC6E5-11411-00	150F ETOX	2001-06	REC6G5-11411-02	200G	1999	REC6G5-11411-02			
115B	1985-01	REC6E5-11411-00	D150H	1999	REC6G5-11411-02	200G ETO	2000	REC6G5-11411-02			
115B ETO	1997-00	REC6N7-11411-00	DX150TLRA	2002	REC67H-11411-00	200G ETOL	2001	REC6G5-11411-02			
115B ETOL	2001-02	REC6N7-11411-00	L150A	1988-89	REC6G5-11411-02	L200A	1988-91	REC6G5-11411-02			
115CEO	1990-98	REC6N7-11411-00	L150CETO	1990-95	REC6R3-11411-00	L200BETO/ET	1990-95	REC6R3-11411-00			
115C ETO	1995-01	REC6N7-11411-00	L150F	1997-98	REC6G5-11411-02	L200F	1997-98	REC6G5-11411-02			
115CETOL/CETOX	2001	REC6N7-11411-00	L150F ETO	2000	REC6G5-11411-02	L200F ETO	2000	REC6G5-11411-02			
130BETO	1990-01	REC6N7-11411-00	L150 FETOL/FETOX	2001	REC6G5-11411-02	PROV200	1991-95	REC6R3-11411-00			
130BETOL/BETOX	2001	REC6N7-11411-00	SX150TXRA	2002	REC67H-11411-00	220AET	1984-96	REC6G5-11411-02			
L130B	1991-98	REC6N7-11411-00	175A	1984-89	REC6G5-11411-02	225AETO	1987-89	REC6G5-11411-02			
L130B ETO	2000	REC6N7-11411-00	175BETO/ET	1990-95	REC6R3-11411-00	225D-DET	1997-01	REC6G5-11411-02			
L130B ETOX	2001	REC6N7-11411-00	175D	1997-98	REC6G5-11411-02						

2T STROKES		2T STROKES		2T STROKES		2T STROKES	
GUÍA PARTES DE CIGÜEÑAL		GUIDE CRANKSHAFT PARTS		GUIDA PARTE ALBERO MOTORE		GUIDE PARTS DE VILEBREQUIN	
2T STROKES		1	2	3	4	2T STROKES	
6B/8B	1980-81	REC677-11412-02	REC677-11422-02	REC677-11432-02	REC677-11442-02		1
E8D	1996-99	REC677-11412-02	REC677-11422-02	REC677-11432-02	REC677-11442-02		
E8D MH	1998-99	REC677-11412-02	REC677-11422-02	REC677-11432-02	REC677-11442-02		
9.9D	1985-97	REC682-11412-00	REC682-11422-00	REC682-11432-00	REC682-11442-00		
9.9D	1988-95	REC63V-11412-00	REC6K4-11422-00	REC6K4-11432-00	REC682-11442-00		
9.9F/MH	1995-14	REC63V-11412-00	REC63V-11422-00	REC63V-11432-00	REC63V-11442-00		
9.9F WH	2000	REC63V-11412-00	REC63V-11422-00	REC63V-11432-00	REC63V-11442-00		
9.9F WHL/S	2001	REC63V-11412-00	REC63V-11422-00	REC63V-11432-00	REC63V-11442-00		
13.5A	1999-06	REC63V-11412-00	REC63V-11422-00	REC63V-11432-00	REC63V-11442-00		
15D	1985-87	REC682-11412-00	REC682-11422-00	REC63V-11432-00	REC682-11442-00		
15D	1988-95	REC682-11412-00	REC6K4-11422-00	REC6K4-11432-00	REC682-11442-00		
15F/MH	1995-14	REC63V-11412-00	REC63V-11412-00	REC63V-11432-00	REC63V-11442-00		
E15D	2003	REC63V-11412-00	REC63V-11422-00	REC63V-11432-00	REC63V-11442-00		
15F WCL	2001-03	REC63V-11412-00	REC63V-11422-00	REC63V-11432-00	REC63V-11442-00		
15 WCS	2001-02	REC63V-11412-00	REC63V-11422-00	REC63V-11432-00	REC63V-11442-00		
20C	1981-86	REC6G0-11412-00	REC6G0-11422-00	REC6G0-11432-00			
20C	1996-02		REC6G0-11422-00	REC6G0-11432-00			
20C M	1990-02	REC6G0-11412-00	REC6G0-11422-00	REC6G0-11432-00			
25D	1985-87	REC6G0-11412-00	REC6G0-11422-00	REC6G0-11432-00			
25D M	1990-97	REC6G0-11412-00	REC6G0-11422-00	REC6G0-11432-00	REC6G0-11442-00		
25D MH	1998	REC6G0-11412-00	REC6G0-11422-00	REC6G0-11432-00	REC6G0-11442-00		
25D MHL/MHS	2001	REC6G0-11412-00	REC6G0-11422-00	REC6G0-11432-00	REC6G0-11442-00		
40X/E40X/MH	1998-02	REC66T-11412-00	REC66T-11422-00	REC66T-11432-00	REC66T-11442-00		
40X MHL	2001-13	REC66T-11412-00	REC66T-11422-00	REC66T-11432-00	REC66T-11442-00		
40X MHS	2001-13	REC66T-11412-00	REC66T-11422-00	REC66T-11432-00	REC66T-11442-00		
40X W	2000	REC66T-11412-00	REC66T-11422-00	REC66T-11432-00	REC66T-11442-00		
40X WL/WS	2001-03	REC66T-11412-00	REC66T-11422-00	REC66T-11432-00	REC66T-11442-00		
40X WT	2000	REC66T-11412-00	REC66T-11422-00	REC66T-11432-00	REC66T-11442-00		
40X WTL	2001-03	REC66T-11412-00	REC66T-11422-00	REC66T-11432-00	REC66T-11442-00		

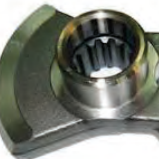



GUÍA  
RODAMIENTOS DE MOTOR

GUIDE  
ENGINE BEARING

GUIDA  
CUSCINETTI MOTORE

GUIDE  
ROULEMENTS DE MOTEUR

		1	2	3	4	5
4A	1985-87	REC93306-304U0		REC93306-304U0	REC93310-112V0	REC93310-418V1
4AC	1987-99	REC93306-304U0		REC93306-304U0	REC93310-112V0	REC93310-418V1
4AC	1999	REC93306-304U0		REC93306-304U0	REC93310-112V0	REC93310-418V1
4AC MHL/MHS	2001-03	REC93306-304U0		REC93306-304U0	REC93310-112V0	REC93310-418V1
4AS	1987-96	REC93306-304U0		REC93306-304U0	REC93310-112V0	REC93310-418V1
4BC	1998-99	REC93306-304U0		REC93306-304U0	REC93310-112V0	REC93310-418V1
4BC	1999	REC93306-304U0		REC93306-304U0	REC93310-112V0	REC93310-418V1
4BC MHL/MHS	2001-03	REC93306-304U0		REC93306-304U0	REC93310-112V0	REC93310-418V1
5C	1985-99	REC93306-304U0		REC93306-304U0	REC93310-112V0	REC93310-418V1
5C MHL/MHS	2001-13	REC93306-304U0		REC93306-304U0	REC93310-112V0	REC93310-418V1
5CS	1987-96	REC93306-304U0		REC93306-304U0	REC93310-112V0	REC93310-418V1
6C	1990	REC93306-204U0	REC93306-204U0	REC93306-204U0	REC93310-112V0	REC93310-418V1
6C	1990-02	REC93306-204U0	REC93306-204U0	REC93306-204U0	REC93310-112V0	REC93310-418V1
6C MHL/MHS	2001-06	REC93306-204U0	REC93306-204U0	REC93306-204U0	REC93310-112V0	REC93310-418V1
6C WHL/WHS	2001	REC93306-204U0	REC93306-204U0	REC93306-204U0	REC93310-112V0	REC93310-418V1
6C	1990	REC93306-204U0	REC93306-204U0	REC93306-204U0	REC93310-112V0	REC93310-418V1
6D	1990-98	REC93306-204U0	REC93306-204U0	REC93306-204U0	REC93310-112V0	REC93310-418V1
6D MHL/MHS	2001-06	REC93306-204U0	REC93306-204U0	REC93306-204U0	REC93310-112V0	REC93310-418V1
6D WHS	2001	REC93306-204U0	REC93306-204U0	REC93306-204U0	REC93310-112V0	REC93310-418V1
8C	1987-02	REC93306-204U0	REC93306-204U0	REC93306-204U0	REC93310-112V0	REC93310-418V1
8C MHL/MHS	2001-12	REC93306-204U0	REC93306-204U0	REC93306-204U0	REC93310-112V0	REC93310-418V1
8C MHX/WHL	2001-03	REC93306-204U0	REC93306-204U0	REC93306-204U0	REC93310-112V0	REC93310-418V1
E8D/MH	1996-99	REC93306-204U0	REC93306-204U0	REC93306-204U0	REC93302-14118	REC93310-418U0
9.9D	1985-89	REC93306-205U2	REC93304-205U0	REC93306-304U0	REC93602-14104	REC93310-620V5
9.9D	1985-95	REC93306-205U2	REC93304-205U0	REC93306-304U0	REC93602-14104	REC93310-620V5
9.9D	1990-95	REC93306-205U2	REC93304-205U0	REC93306-304U0	REC93602-14104	REC93310-620V5
9.9F	1995-99	REC93306-205U7	REC93306-205U7	REC93306-205U7	REC93602-14104	REC93310-620V5
9.9F MH	2000	REC93306-205U7	REC93306-205U7	REC93306-205U7	REC93602-14104	REC93310-620V5
9.9F MHL/MHS	2001-06	REC93306-205U7	REC93306-205U7	REC93306-205U7	REC93602-14104	REC93310-620V5
9.9F WC/WH	2000	REC93306-205U7	REC93306-205U7	REC93306-205U7	REC93602-14104	REC93310-620V5
9.9F WHL/WHS	2001	REC93306-205U7	REC93306-205U7	REC93306-205U7	REC93602-14104	REC93310-620V5
13.5A	1999	REC93306-205U7	REC93306-205U7	REC93306-205U7	REC93602-14104	REC93310-620V5
13.5A MH	2000	REC93306-205U7	REC93306-205U7	REC93306-205U7	REC93602-14104	REC93310-620V5
13.5A MHL/MHS	2001-04	REC93306-205U7	REC93306-205U7	REC93306-205U7	REC93602-14104	REC93310-620V5
13.5A WH	2000	REC93306-205U7	REC93306-205U7	REC93306-205U7	REC93602-14104	REC93310-620V5
15D	1985-89	REC93306-205U2	REC93304-205U0	REC93306-304U0	REC93602-14104	REC93310-620V5
15D	1985	REC93306-205U2	REC93304-205U0	REC93306-304U0	REC93602-14104	REC93310-620V5
15D	1990-95	REC93306-205U2	REC93304-205U0	REC93306-304U0	REC93602-14104	REC93310-620V5
15F	1995-99	REC93306-205U7	REC93306-205U7	REC93306-205U7	REC93602-14104	REC93310-620V5
15F MH	2000	REC93306-205U7	REC93306-205U7	REC93306-205U7	REC93602-14104	REC93310-620V5
15F MHL/MHS	2001-06	REC93306-205U7	REC93306-205U7	REC93306-205U7	REC93602-14104	REC93310-620V5
15F WC	2000	REC93306-205U7	REC93306-205U7	REC93306-205U7	REC93602-14104	REC93310-620V5
15F WCL/WCS	2001-03	REC93306-205U7	REC93306-205U7	REC93306-205U7	REC93602-14104	REC93310-620V5
20C	1985	REC93306-305I0		REC93306-305I0	REC93602-20M02	REC93310-522W0
20C	1986-93	REC93306-305I0		REC93306-305I0	REC93602-20M02	REC93310-522W0
20C	1993	REC93306-305U3		REC93306-305U3	REC93602-20M02	REC93310-522W0
20C M	1990-97	REC93306-305U3		REC93306-305U3	REC93602-20M02	REC93310-522W0
20C MH	1998	REC93306-305U3		REC93306-305U3	REC93602-20M02	REC93310-522W0
20C MHL/MHS	2001-02	REC93306-305U3		REC93306-305U3	REC93602-20M02	REC93310-522W0
20DEM	1994-98	REC93311-632U7	REC93306-305U3	REC93306-305U3		
20D MHOL/MHOS	2001-06	REC93311-632U7	REC93306-305U3	REC93306-305U3		
20D WOL/WOS	2006	REC93311-632U7	REC93306-305U3	REC93306-305U3		
25B	1994-95	REC93311-636U6		REC93306-306V1	REC93603-18M09	REC93603-18M09
25B MHL/MHS	2001-06	REC93399-99951		REC93306-305U3	REC93602-20M02	
25B WCS	2001-02	REC93399-99951		REC93306-305U3	REC93602-20M02	
25D	1985	REC93306-305I0		REC93306-305I0	REC93602-20M02	REC93310-522W0
25D	1986-87	REC93306-305I0		REC93306-305I0	REC93602-20M02	REC93310-522W0
25D M	1990-97	REC93311-632U7	REC93306-305U3	REC93306-305U3	REC93602-20M02	REC93310-522W0
25D MH	1998	REC93311-632U7	REC93306-305U3	REC93306-305U3	REC93602-20M02	REC93310-522W0
25D MHL/MHS	2001	REC93311-632U7	REC93306-305U3	REC93306-305U3	REC93602-20M02	REC93310-522W0
25J	1987-2000			REC93306-305U3		
25J	1992-2000	REC93311-632U7		REC93306-305U3		
25N	1994-98	REC93311-632U7	REC93306-305U3	REC93306-305U3		
25N MHOL/MHOS	2001-06	REC93311-632U7	REC93306-305U3	REC93306-305U3		
25N WOL/WOS	2001-03	REC93311-632U7	REC93306-305U3	REC93306-305U3		
25V	1996	REC93311-632U7	REC93306-305U3	REC93306-305U3	REC93602-20M02	
25V	1997-98	REC93311-632V4	REC93306-305U3	REC93306-305U3	REC93602-20M02	REC93310-624U5
25V MHL/MHS	2001	REC93311-632V4	REC93306-305U3	REC93306-305U3	REC93602-20M02	REC93310-624U5
25V WCS	2001	REC93311-632V4	REC93306-305U3	REC93306-305U3	REC93602-20M02	REC93310-624U5
30A	1985			REC93306-305I0	REC93602-20M02	REC93310-624U5
30A M	1990-92			REC93306-305U3	REC93602-20M02	REC93310-624U5
30D	1986-99			REC93306-305U3		
30D	1992-00	REC93311-632U7		REC93306-305U3		
30D EOL/ETOL	2001-06	REC93311-632U7		REC93306-305U3		
30D MHOL/MHOS	2001-06	REC93311-632U7		REC93306-305U3		
30D OL	2001-03	REC93311-632U7		REC93306-305U3		
30D EOS	2001-06	REC93311-632U7		REC93306-305U3		
30G	1996	REC93311-632U7		REC93306-305U3	REC93602-20M02	REC93310-624U5

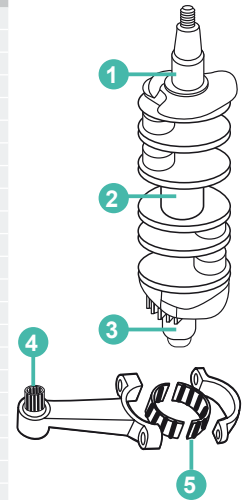





1 2 3 4 5

30G	1996-98	REC93311-632V4		REC93306-305U3	REC93602-20M02	REC93310-624U5
30G MHS/WCS	2001	REC93311-632V4		REC93306-305U3	REC93602-20M02	REC93310-624U5
30H MHS	2001-03	REC93311-632V4		REC93306-305U3	REC93602-20M02	REC93310-624U5
30H WCS	2001-02	REC93311-632V4		REC93306-305U3	REC93602-20M02	
40H	1984-87	REC93306-305U8		REC93306-30510	REC93602-20M02	
40Q	1993-98		REC93311-832U4		REC93603-21111	REC93310-730V6
40Q E/M	1992		REC93311-832U4		REC93603-21111	REC93310-730V6
40R MHO	2000				REC93602-20M02	
40R ROS	2001				REC93602-20M02	
40V	1994-99	REC93306-305U8		REC93306-305U8	REC93602-20M02	
40V EO	2000	REC93306-305U8		REC93306-305U8	REC93602-20M02	
40V EOL/EOS	2001-06	REC93306-305U8		REC93306-305U8	REC93602-20M02	
40V ETO	2000	REC93306-305U8		REC93306-305U8	REC93602-20M02	
40V ETOL/ETOS	2001-03	REC93306-305U8		REC93306-305U8	REC93602-20M02	
40V MHOL/MHOS	2001-06	REC93306-305U8		REC93306-305U8	REC93602-20M02	
40V MO	2000	REC93306-305U8		REC93306-305U8	REC93602-20M02	
40V MOS	2002-05	REC93306-305U8		REC93306-305U8	REC93602-20M02	
40X	1998	REC93306-307U0	REC93332-000UE	REC93306-306V5	REC93603-21111	REC93310-727U0
40X MH	2000	REC93306-307U0	REC93332-000UE	REC93306-306V5	REC93603-21111	REC93310-727U0
40X MHL	2001-06	REC93306-307U0	REC93332-000UE	REC93306-306V5	REC93603-21111	REC93310-727U0
40X WL/WS	2001	REC93306-307U0	REC93332-000UE	REC93306-306V5	REC93603-21111	REC93310-727U0
40X WT	2000	REC93306-307U0	REC93332-000UE	REC93306-306V5	REC93603-21111	REC93310-727U0
40X WTL	2001-03	REC93306-307U0	REC93332-000UE	REC93306-306V5	REC93603-21111	REC93310-727U0
40Y ETOL	2001-06	REC93306-305U8		REC93306-305U8	REC93602-20M02	
40Y MHOS	2001-06	REC93306-305U8		REC93306-305U8	REC93602-20M02	
E40G	2003	REC93306-307U0	REC93332-000UE	REC93306-306V1	REC93603-21111	REC93310-727V7
E40J	2003	REC93306-307U0	REC93332-000UE	REC93306-306V1	REC93603-21111	REC93310-727V7
50D	1984-90	REC93306-305U8		REC93306-30510	REC93602-20M02	
50G	1993-98	REC93311-636U6		REC93306-306V1	REC93603-18M09	REC93310-522W0
50G ETO	2000	REC93311-636U6		REC93306-306V1	REC93603-18M09	REC93310-522W0
50G ETOL	2001-06	REC93311-636U6		REC93306-306V1	REC93603-18M09	REC93310-522W0
50H	1994-99	REC93306-305U8		REC93306-305U8	REC93602-20M02	REC93310-522W0
50H EDO	2000	REC93306-305U8		REC93306-305U8	REC93602-20M02	REC93310-522W0
50H EDOL/EDOS	2001-02	REC93306-305U8		REC93306-305U8	REC93602-20M02	REC93310-522W0
50H MDO/MO	2000	REC93306-305U8		REC93306-305U8	REC93602-20M02	REC93310-522W0
55B	1993-98	REC93311-632U1			REC93603-21111	REC93311-832U4
55B E	1990-00	REC93311-632U1	REC93311-832U4		REC93603-21111	REC93311-832U4
55B EHD/ET	2000	REC93311-632U1	REC93311-832U4		REC93603-21111	REC93311-832U4
55B ETL	2001-02	REC93311-632U1	REC93311-832U4		REC93603-21111	REC93311-832U4
60F	1984-98	REC93311-636U6		REC93306-306V1	REC93603-18M09	
60F EO/ETO	2000	REC93311-636U6		REC93306-306V1	REC93603-18M09	
60F ETOL	2001-06	REC93311-636U6		REC93306-306V1	REC93603-18M09	
E60HMHD	2003	REC93311-636U6		REC93306-306V1		REC93310-527W1
E60 ELHB	2003	REC93311-636U6		REC93306-306V1		REC93310-527W1
E60H MHDL	2001-06	REC93311-636U6		REC93306-306V1	REC93603-18M09	
70B	1984-98	REC93311-636U6		REC93306-306V1	REC93603-18M09	
70B EDOL	2001	REC93311-636U6		REC93306-306V1	REC93603-18M09	
70B EO/ETO	2000	REC93311-636U6		REC93306-306V1	REC93603-18M09	
70B ETOL	2001-06	REC93311-636U6		REC93306-306V1	REC93603-18M09	
75A	1993-98	REC93310-636U4	REC93310-835U8	REC93306-206U5	REC93603-21111	REC93310-730V8
75A E	1990-00	REC93310-636U4	REC93310-835U8	REC93306-206U5	REC93603-21111	REC93310-730V8
75A EDL	2001-06	REC93310-636U4	REC93310-835U8	REC93306-206U5	REC93603-21111	REC93310-730V8
75A EM	1992	REC93310-636U4	REC93310-835U8	REC93306-206U5	REC93603-21111	REC93310-730V8
75A ET/ETL	2000	REC93310-636U4	REC93310-835U8	REC93306-206U5	REC93603-21111	REC93310-730V8
75A MHD	2000	REC93310-636U4	REC93310-835U8	REC93306-206U5	REC93603-21111	REC93310-730V8
75C	1998	REC93310-636U4	REC93310-835U8	REC93306-206U5	REC93603-21111	REC93310-730V8
75C ETO	2000	REC93310-636U4	REC93310-835U8	REC93306-206U5	REC93603-21111	REC93310-730V8
75C ETOL	2001-06	REC93310-636U4	REC93310-835U8	REC93306-206U5	REC93603-21111	REC93310-730V8
80A	1985-95	REC93310-636U4	REC93310-835U8	REC93306-206U5	REC93603-21111	REC93310-730V8
85A	1996-98	REC93310-636U4	REC93310-835U8	REC93306-206U5	REC93603-21111	REC93310-730V8
85A E	1990-2000	REC93310-636U4	REC93310-835U8	REC93306-206U5	REC93603-21111	REC93310-730V8
85A ET/ETL	2000	REC93310-636U4	REC93310-835U8	REC93306-206U5	REC93603-21111	REC93310-730V8
90A	1984-98	REC93310-636U4	REC93310-835U8	REC93306-206U5	REC93603-21111	REC93310-730V8
90A ETO/ETOL	2000	REC93310-636U4	REC93310-835U8	REC93306-206U5	REC93603-21111	REC93310-730V8
100A	1998	REC93311-940U3	REC93310-954U1	REC93306-208U0	REC93310-32337	REC93310-836V2
100A ETO	2000	REC93311-940U3	REC93310-954U1	REC93306-208U0	REC93310-32337	REC93310-836V2
100A ETOL	2001	REC93311-940U3	REC93310-954U1	REC93306-208U0	REC93310-32337	REC93310-836V2
115A	1984-87	REC93311-940U3	REC93310-954V3	REC93306-208U0	REC93603-21111	REC93310-836V2
115B	1988-92	REC93311-940U3	REC93310-954V3	REC93306-208U0	REC93603-21111	REC93310-836V2
115B	1993-96	REC93311-940U3	REC93310-954V3	REC93306-208U0	REC93310-32337	REC93310-836V2
115B ETOL	2001-02	REC93311-940U3	REC93310-954U1	REC93306-208U0	REC93310-32337	REC93310-836U0
115C	1988-91	REC93311-940U3	REC93310-954V3	REC93306-208U0	REC93603-21111	REC93310-836V2
115C	1992-98	REC93311-940U3	REC93310-954V3	REC93306-208U0	REC93310-32337	REC93310-836V2
115C ETO	2000	REC93311-940U3	REC93310-954U1	REC93306-208U0	REC93310-32337	REC93310-836V2
115C ETOL	2001	REC93311-940U3	REC93310-954U1	REC93306-208U0	REC93310-32337	REC93310-836U0
115C ETOX	1988-91	REC93311-940U3	REC93310-954U1	REC93306-208U0	REC93310-32337	REC93310-836V2
130B	1992-98	REC93311-940U3	REC93310-954V3	REC93306-208U0	REC93603-21111	REC93310-836V2
130B	2001-06	REC93311-940U3	REC93310-954U1	REC93306-208U0	REC93310-32337	REC93310-836V2
130B ETO	2000-2005	REC93306-307U0	REC93332-000UE	REC93306-208U0	REC93603-21111	REC93310-836V2
130B ETOL	2001-06	REC93311-940U3	REC93310-954U1	REC93306-208U0	REC93310-32337	REC93310-836V2
130B ETOX	2001	REC93311-940U3	REC93310-954U1	REC93306-208U0	REC93310-32337	REC93310-836U0
L130B	1988-91	REC93311-940U3	REC93310-954U1	REC93306-208U0	REC93310-32337	REC93310-836V2
L130B	1992-98	REC93311-940U3	REC93310-954U1	REC93306-208U0	REC93603-21111	REC93310-836V2

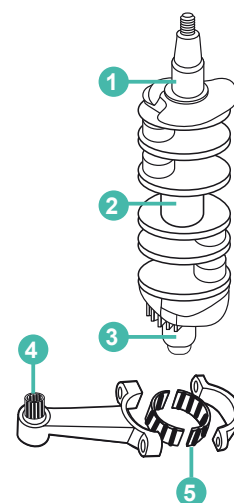



		1	2	3	4	5
L130B ETO	2000	REC93311-940U3	REC93310-954U1	REC93306-208U0	REC93310-32337	REC93310-836V2
L130B ETO	2001	REC93311-940U3	REC93310-954U1	REC93306-208U0	REC93310-32337	REC93310-836V2
140A	1984-89	REC93311-940U3	REC93310-954U1	REC93306-208U0	REC93310-32337	REC93310-836V2
140B	1988-89	REC93311-940U3	REC93310-954V3	REC93306-208U0	REC93603-21111	REC93310-836V2
L140B	1989	REC93311-940U3	REC93310-954V3	REC93306-208U0	REC93603-21111	REC93310-836V2
150A	1984-89	REC93311-940U3	REC93310-954V3	REC93306-208U0	REC93603-21111	REC93310-836V2
150A ET	1998-00	REC93311-940U3	REC93310-954V3	REC93306-208U0	REC93603-21111	REC93310-836V2
150A ETL	2001-02	REC93311-940U3	REC93310-954U1	REC93306-208U0	REC93310-32337	REC93310-836V2
150A ETX	2001-02	REC93311-940U3	REC93310-954U1	REC93306-208U0	REC93310-32337	REC93310-836V2
L150C	1988-91	REC93311-940U3	REC93310-954U1	REC93306-208U0	REC93310-32337	REC93310-836V2
150C	1988-91	REC93311-940U3	REC93310-954V3	REC93306-208U0	REC93603-21111	REC93310-836V2
150C	1992-95	REC93311-940U3	REC93310-954V3	REC93306-208U0	REC93603-21111	REC93310-836V2
150F	1996-98	REC93311-940U3	REC93310-954V3	REC93306-208U0	REC93310-32337	REC93310-836V2
150F ETO	2000	REC93311-940U3	REC93310-954U1	REC93306-208U0	REC93310-32337	REC93310-836V2
150F ETOL	2001-06	REC93311-940U3	REC93310-954U1	REC93306-208U0	REC93310-32337	REC93310-836V2
150F ETOX	2001-06	REC93311-940U3	REC93310-954U1	REC93306-208U0	REC93310-32337	REC93310-836V2
D150H	1999	REC93311-940U3	REC93310-954U1	REC93306-208U0	REC93310-32337	REC93310-836V2
D150HETO	2001-02	REC93311-940U3	REC93310-954U1	REC93306-208U0	REC93310-32337	REC93310-836V2
L150A	1988-89	REC93311-940U3	REC93310-954U1	REC93306-208U0	REC93310-32337	REC93310-836V2
L150C	1990-95	REC93311-940U3	REC93310-954V3	REC93306-208U0	REC93603-21111	REC93310-836V2
L150F	1996-98	REC93311-940U3	REC93310-954V3	REC93306-208U0	REC93310-32337	REC93310-836V2
L150F ETO	2000	REC93311-940U3	REC93310-954U1	REC93306-208U0	REC93310-32337	REC93310-836V2
L150F ETOL	2001	REC93311-940U3	REC93310-954U1	REC93306-208U0	REC93310-32337	REC93310-836V2
L150 EOTX	2001	REC93311-940U3	REC93310-954U1	REC93306-208U0	REC93310-32337	REC93310-836V2
LZ150PETO	2000-06	REC93311-940U3	REC93310-954U1	REC93306-208U0	REC93310-32337	REC93310-836V2
Z150P ETO	2000	REC93311-940U3	REC93310-954U1	REC93306-208U0	REC93310-32337	REC93310-836U0
Z150P ETO	2001-06	REC93311-940U3	REC93310-954U1	REC93306-208U0	REC93310-32337	REC93310-836U0
Z150Q ETO	2000	REC93311-940U3	REC93310-954U1	REC93306-208U0	REC93310-32337	REC93310-836U0
Z150Q ETOL	2001-06	REC93311-940U3	REC93310-954U1	REC93306-208U0	REC93310-32337	REC93310-836U0
175A	1984-89	REC93311-940U3	REC93310-954U1	REC93306-208U0	REC93310-32337	REC93310-836U0
175B	1978-95	REC93311-940U3	REC93310-954V3	REC93306-208U0	REC93603-21111	REC93310-836V2
175D	1996-98	REC93311-940U3	REC93310-954V3	REC93306-208U0	REC93310-32337	REC93310-836V2
175D ETO/ETOL	2000	REC93311-940U3	REC93310-954U1	REC93306-208U0	REC93310-32337	REC93310-836V2
175D ETOX/ETOL	2001-02	REC93311-940U3	REC93310-954U1	REC93306-208U0	REC93310-32337	REC93310-836V2
175D ETOL	2001	REC93311-940U3	REC93310-954U1	REC93306-208U0	REC93310-32337	REC93310-836V2
Z175G ETOX	2001-06	REC93311-940U3	REC93310-954U1	REC93306-208U0	REC93310-32337	REC93310-836U0
200A	1984-89	REC93311-940U3	REC93310-954U1	REC93306-208U0	REC93310-32337	REC93310-836U0
200B	1990-95	REC93311-940U3	REC93310-954V3	REC93306-208U0	REC93603-21111	REC93310-836V2
200F	1996-98	REC93311-940U3	REC93310-954V3	REC93306-208U0	REC93310-32337	REC93310-836V2
200F ETO/ETOL	2000	REC93311-940U3	REC93310-954U1	REC93306-208U0	REC93310-32337	REC93310-836V2
200F ETOX	2001-06	REC93311-940U3	REC93310-954U1	REC93306-208U0	REC93310-32337	REC93310-836V2
200G	1999-02	REC93311-940U3	REC93310-954U1	REC93306-208U0	REC93310-32337	REC93310-836V2
200G ETO/ETOL	2000	REC93311-940U3	REC93310-954U1	REC93306-208U0	REC93310-32337	REC93310-836V2
L200A	1988-91	REC93311-940U3	REC93310-954U1	REC93306-208U0	REC93310-32337	REC93310-836V2
L200B	1992-95	REC93311-940U3	REC93310-954V3	REC93306-208U0	REC93603-21111	REC93310-836V2
L200F	1996-98	REC93311-940U3	REC93310-954V3	REC93306-208U0	REC93310-32337	REC93310-836V2
L200F ETO/ETOL	2000	REC93311-940U3	REC93310-954U1	REC93306-208U0	REC93310-32337	REC93310-836V2
LZ200N ETO	2000	REC93311-940U3	REC93310-954U1	REC93306-208U0	REC93310-32337	REC93310-836V2
LZ200NETO		REC93311-940U3	REC93310-954U1	REC93306-208U0	REC93310-32337	REC93310-836U0
Z200N ETO	2001-06	REC93311-940U3	REC93310-954U1	REC93306-208U0	REC93310-32337	REC93310-836U0
Z200 N ETOL	2000	REC93311-940U3	REC93310-954U1	REC93306-208U0	REC93310-32337	REC93310-836U0
Z200N ETOX/ETOL	2001-06	REC93311-940U3	REC93310-954U1	REC93306-208U0	REC93310-32337	REC93310-836U0
220A	2003-06	REC93311-940U3	REC93310-954U1	REC93306-208U0	REC93310-32337	REC93310-836U0
225A	1984-86	REC93311-940U3	REC93310-954V3	REC93306-208U0	REC93603-21111	REC93310-836V2
225A	1987-89	REC93311-940U3	REC93310-954V3	REC93306-208U0	REC93603-21111	REC93310-836V2
225D ETO	2000	REC93311-940U3	REC93310-954U1	REC93306-208U0	REC93310-32337	REC93310-836V2
225D ETOX/ETOL	2001-03	REC93311-940U3	REC93310-954U1	REC93306-208U0	REC93310-32337	REC93310-836V2
250AET	1996-06				REC93310-326V4	
250B	95-02				REC93310-326V4	
225G	99-03				REC93310-326V4	
225A	1984-86	REC93311-940U3	REC93310-954V3	REC93306-208U0	REC93603-21111	REC93310-836V2
225A	1987-89	REC93311-940U3	REC93310-954V3	REC93306-208U0	REC93603-21111	REC93310-836V2
225D ETO	2000	REC93311-940U3	REC93310-954U1	REC93306-208U0	REC93310-32337	REC93310-836V2
225D ETOX/ETOL	2001-03	REC93311-940U3	REC93310-954U1	REC93306-208U0	REC93310-32337	REC93310-836V2
250AET	1996-06				REC93310-326V4	
250B	95-02				REC93310-326V4	
225G	99-03				REC93310-326V4	
Z, LZ						
225/250/300 HP V6	1990-10	REC93306-209U1				

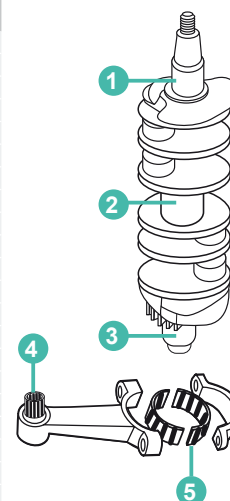

GUÍA DE BIELAS

GUIDE CONNECTING ROAD

GUIDA BIELLE

GUIDE DE BIELLES

		1	2	3	4	5
2B	1986-02	REC646-11651-02			REC646-11681-00	REC90209-18112
2MSHA/S/B	2002-03	REC646-11651-02			REC646-11681-00	
2CMHS	2010	REC646-11651-02			REC646-11681-00	
4A	1985-87	REC6E0-11651-01	REC6G1-11633-00		REC6G1-11681-00	
4AC	1987-99	REC6E0-11651-01	REC6G1-11633-00		REC6G1-11681-00	REC90209-18112
4AC MHL/HS	2001-03	REC6E0-11651-01	REC6G1-11633-00		REC6G1-11681-00	REC90209-18112
4AS	1987-96	REC6E0-11651-01	REC6G1-11633-00		REC6G1-11681-00	REC90209-18112
4BC	1998-99	REC6E0-11651-01	REC6G1-11633-00		REC6G1-11681-00	REC90209-18112
4BC	1999	REC6E0-11651-01	REC6G1-11633-00		REC6G1-11681-00	REC90209-18112
4BC MHL/HS	2001-03	REC6E0-11651-01	REC6G1-11633-00		REC6G1-11681-00	REC90209-18112
5C	1985-99	REC6E0-11651-01	REC6G1-11633-00		REC6G1-11681-00	REC90209-18112
5C MHL/MHS	2001-06	REC6E0-11651-01	REC6G1-11633-00	REC90201-12565	REC6G1-11681-00	REC90209-18112
5CS	1987-96	REC650-11651-04	REC634-11633-00	REC90201-14377	REC682-11681-00	REC90209-20159
6C	1990		REC634-11633-00	REC90201-14377	REC682-11681-00	REC90209-20159
6C	1990-98		REC634-11633-00	REC90201-14377	REC682-11681-00	REC90209-20159
6C MHL/HS	2001-06		REC634-11633-00	REC90201-14377	REC682-11681-00	REC90209-18112
6C WHL/HS	2001		REC634-11633-00	REC90201-14377	REC682-11681-00	REC90209-18112
6C	1990		REC634-11633-00	REC90201-14377	REC682-11681-00	REC90209-18112
6D	1990-98		REC634-11633-00	REC90201-14377	REC682-11681-00	REC90209-18112
6D MHL/HS	2001-06		REC634-11633-00	REC90201-14377	REC682-11681-00	REC90209-18112
6D WHS	2001		REC634-11633-00	REC90201-14377	REC682-11681-00	REC90209-18112
8C	1990-98	REC677-11651-00	REC634-11633-00	REC90201-14377	REC682-11681-00	REC90209-18112
8C	1990	REC677-11651-00	REC634-11633-00	REC90201-14377	REC682-11681-00	REC90209-18112
8C MHL/HS	2001-06	REC677-11651-00	REC634-11633-00	REC90201-14377	REC682-11681-00	REC90209-20159
8C MHX	2001-03	REC677-11651-00	REC634-11633-00	REC90201-14377	REC682-11681-00	REC90209-20159
8C WHL/HS	2001-02	REC677-11651-00	REC634-11633-00	REC90201-14377	REC682-11681-00	REC90209-20159
E8D	1997-98	REC6E0-11651-01	REC634-11633-00	REC90201-14377	REC682-11681-00	REC90209-18112
E8D MH	1999	REC6E0-11651-01	REC634-11633-00	REC90201-14377	REC682-11681-00	REC90209-18112
9.9D	1985-89	REC650-11651-04	REC634-11633-00	REC90201-14377	REC682-11681-00	
9.9D	1985-95	REC6K4-11651-00	REC634-11633-00	REC90201-14377	REC682-11681-00	
9.9D	1990-95	REC6K4-11651-00	REC634-11633-00	REC90201-14377	REC648-11681-00	REC90209-20159
9.9F	1995-99	REC648-11651-00	REC648-11633-00	REC90201-14377	REC682-11681-00	REC90209-20159
9.9F MH	2000	REC648-11651-00	REC648-11633-00	REC90201-14377	REC682-11681-00	REC90209-20159
9.9F MHL	2001-06	REC648-11651-00	REC648-11633-00	REC90201-14377	REC682-11681-00	REC90209-20159
9.9F MHS	2001-06	REC648-11651-00	REC648-11633-00	REC90201-14377	REC682-11681-00	REC90209-20159
9.9F WC	2000	REC648-11651-00	REC648-11633-00	REC90201-20M27	REC682-11681-00	
9.9F WH	2000	REC689-11651-00	REC689-11633-00	REC90201-20M27	REC689-11681-00	REC90209-24M03
9.9F WHL/HS	2001	REC689-11651-00	REC689-11633-00	REC90201-20M27	REC689-11681-00	REC90209-24M03
13.5A	1999	REC689-11651-00	REC689-11633-00	REC90201-20M27	REC689-11681-00	REC90209-24M03
13.5A MH	2000	REC689-11651-00	REC689-11633-00	REC90201-20M27	REC689-11681-00	REC90209-24M03
13.5A MHL	2001-04	REC689-11651-00	REC689-11633-00	REC90201-20M27	REC689-11681-00	REC90209-24M03
13.5A MHS	2001-04	REC689-11651-00	REC648-11633-00	REC90201-14377	REC648-11681-00	
13.5A WH	2000	REC648-11651-00	REC648-11633-00	REC90201-14377	REC648-11681-00	
15D	1985-89	REC648-11651-00	REC648-11633-00	REC90201-14377	REC648-11681-00	
15D	1985-95	REC648-11651-00	REC648-11633-00	REC90201-14377	REC648-11681-00	
15D	1990-95	REC648-11651-00	REC648-11633-00	REC90201-14377	REC648-11681-00	
15F	1995-99	REC648-11651-00	REC689-11633-00	REC90201-20M27	REC689-11681-00	REC90209-24M03
15F MH	2000	REC689-11651-00	REC689-11633-00	REC90201-20M27	REC689-11681-00	REC90209-24M03
15F MHL/HS	2001-06	REC689-11651-00	REC689-11633-00	REC90201-20M27	REC689-11681-00	REC90209-24M03
13.5A MH	2000	REC689-11651-00	REC689-11633-00	REC90201-20M27	REC689-11681-00	REC90209-24M03
13.5A MHL	2001-04	REC689-11651-00	REC689-11633-00	REC90201-20M27	REC689-11681-00	REC90209-24M03
13.5A MHS	2001-04	REC689-11651-00	REC648-11633-00	REC90201-14377	REC648-11681-00	
13.5A WH	2000	REC648-11651-00	REC648-11633-00	REC90201-14377	REC648-11681-00	
15D	1985-89	REC648-11651-00	REC648-11633-00	REC90201-14377	REC648-11681-00	
15D	1985-95	REC648-11651-00	REC648-11633-00	REC90201-14377	REC648-11681-00	
15D	1990-95	REC648-11651-00	REC648-11633-00	REC90201-14377	REC648-11681-00	
15F	1995-99	REC648-11651-00	REC689-11633-00	REC90201-20M27	REC689-11681-00	REC90209-24M03
15F MH	2000	REC689-11651-00	REC689-11633-00	REC90201-20M27	REC689-11681-00	REC90209-24M03
15F MHL/HS	2001-06	REC689-11651-00	REC689-11633-00	REC90201-20M27	REC689-11681-00	REC90209-24M03
15F WC	2000	REC689-11651-00	REC689-11633-00	REC90201-20M27	REC689-11681-00	REC90209-24M03
15F WCL	2001-03	REC689-11651-00	REC689-11633-00	REC90201-20M27	REC689-11681-00	REC90209-24M03
15F WCS	2001-02	REC689-11651-00	REC689-11633-00	REC90201-20M27	REC689-11681-00	REC90209-24M03
20C	1985-93	REC689-11651-00	REC689-11633-00	REC90201-20M27	REC689-11681-00	REC90209-24M03
20C	1986-02	REC648-11651-00	REC648-11633-00	REC90201-20417	REC648-11681-00	
20C	1993	REC6F5-11651-00	REC6F5-11633-00	REC90201-20417	REC66T-11681-00	REC90209-27M07
20C M	1990-97	REC6F5-11651-00	REC6F5-11633-00	REC90201-20417	REC66T-11681-00	REC90209-27M07
20C MH	1998	REC6F5-11651-00	REC6F5-11633-00	REC90201-20417	REC66T-11681-00	REC90209-27M07
20C MHL	2001-02	REC6F5-11651-00	REC6F5-11633-00	REC90201-20417	REC66T-11681-00	REC90209-27M07
20C MHS	2001-02	REC6F5-11651-00	REC6F5-11633-00	REC90201-20417	REC66T-11681-00	REC90209-27M07
20D	1994-98	REC6F5-11651-00	REC6F5-11633-00	REC90201-20417	REC66T-11681-00	REC90209-27M07
20D MHOL	2001-06	REC6F5-11651-00	REC6F5-11633-00	REC90201-20417	REC66T-11681-00	REC90209-27M07
20D MHOS	2001-06	REC6F5-11651-00	REC6F5-11633-00	REC90201-20417	REC66T-11681-00	REC90209-27M07
20D WOL/OS	2006	REC6F5-11651-00	REC6F5-11633-00	REC90201-20417	REC66T-11681-00	REC90209-27M07
25B	1994-02	REC689-11651-00	REC663-11633-00	REC90201-20417	REC689-11681-00	REC90209-24M03
25B MHL/HS	2001-06	REC689-11651-00	REC663-11633-00	REC90201-20417	REC689-11681-00	REC90209-24M03
25B WCS	2001-02	REC689-11651-00	REC663-11633-00	REC90201-20417	REC689-11681-00	REC90209-24M03
25D	1985-01	REC648-11651-00	REC663-11633-00	REC90201-20417	REC648-11681-00	
25D	1986-87	REC648-11651-00	REC663-11633-00	REC90201-20417	REC648-11681-00	
25D M	1990-97	REC648-11651-00	REC663-11633-00	REC90201-20417		
25D MH	1998	REC648-11651-00				
25D MHL	2001	REC648-11651-00				

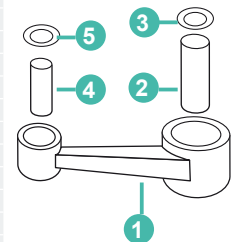

YAMAHA

RECAMBIOS MARINOS





1

2

3

4

5

25D MHS	2001	REC648-11651-00					
25N	1994-98		REC6H3-11633-00	REC90201-20417			
25N MHOL/S	2001-06	REC689-11651-00	REC663-11633-00	REC90201-20417			
25N WOL/WOS	2001-03	REC689-11651-00	REC663-11633-00	REC90201-20417			
25V	1996-98	REC689-11651-00	REC663-11633-00	REC90201-20417	REC689-11681-00	REC90209-24M03	
25V MHL/HS	2001	REC689-11651-00	REC663-11633-00	REC90201-20417	REC689-11681-00	REC90209-24M03	
25V WCS	2001	REC689-11651-00	REC663-11633-00	REC90201-20417	REC689-11681-00	REC90209-24M03	
30A	1985	REC689-11651-00	REC663-11633-00	REC90201-20417	REC689-11681-00	REC90209-24M03	
30A M	1990-92	REC689-11651-00	REC663-11633-00	REC90201-20417	REC689-11681-00	REC90209-24M03	
30D	1986-00	REC689-11651-00	REC663-11633-00	REC90201-20417			
30D EOL/EOS	2001-06	REC689-11651-00	REC663-11633-00	REC90201-20417			
30D ETOL	2001-06	REC689-11651-00	REC663-11633-00	REC90201-20417			
30D MHOL	2001-06	REC689-11651-00	REC663-11633-00	REC90201-20417			
30D MHOS	2001-05	REC689-11651-00	REC663-11633-00	REC90201-20417			
30D OL	2001-03	REC689-11651-00	REC663-11633-00	REC90201-20417			
30D EOS	2001-06		REC6R5-11633-00	REC90201-23M01			
40G/J	1986-89	REC6F5-11651-00	REC6F5-11633-00		REC6F5-11681-00	REC90209-27M11	
40R ROS	2001		REC6R5-11633-00	REC90201-23M01			
40V	1994-99	REC6H4-11651-00	REC6R5-11633-00	REC90201-23M01			
40V EO	2000	REC6E5-11651-00	REC6R5-11633-00	REC90201-23M01			
40V EOL/EOS	2001-06		REC6R5-11633-00	REC90201-23M01			
40V ETO	2000	REC6E5-11651-00	REC6E5-11633-00				
40V ETOL	2001-03	REC6E5-11651-00					
40V ETOS	2001-03	REC6E5-11651-00					
40V MHOL	2001-06	REC6E5-11651-00					
40V MHOS	2001-06		REC6E5-11633-00				
40V MO	2000		REC6R5-11633-00	REC90201-23M01			
40V MOS	2002-05		REC6R5-11633-00	REC90201-23M01			
40X	1998	REC6F5-11651-00	REC6F5-11633-00	REC90201-23M01	REC66T-11681-00	REC90209-27M07	
40X MH	2000	REC6F5-11651-00	REC6F5-11633-00	REC90201-23M01	REC66T-11681-00	REC90209-27M07	
40X MHL	2001-06	REC6F5-11651-00	REC6F5-11633-00	REC90201-23M01	REC66T-11681-00	REC90209-27M07	
40 MHS	2001-02	REC6F5-11651-00	REC6F5-11633-00	REC90201-23M01	REC66T-11681-00	REC90209-27M07	
40X W	2000	REC6F5-11651-00	REC6F5-11633-00	REC90201-23M01	REC66T-11681-00	REC90209-27M07	
40X WL	2001	REC6F5-11651-00	REC6F5-11633-00	REC90201-23M01	REC66T-11681-00	REC90209-27M07	
40X WS	2001	REC6E5-11651-00	REC6F5-11633-00		REC66T-11681-00	REC90209-27M07	
40X WT	2000	REC6E5-11651-00	REC6F5-11633-00	REC90201-23M01	REC66T-11681-00	REC90209-27M07	
40X WTL	2001-03		REC6F5-11633-00	REC90201-23M01	REC66T-11681-00	REC90209-27M07	
40Y ETOL	2001-06		REC6R5-11633-00	REC90201-23M01			
40Y MHOS	2001-06		REC6R5-11633-00	REC90201-23M01			
40GM,W,J	2003-04	REC6F5-11651-00	REC6F5-11633-00	REC90209-27M07	REC6F5-11681-00	REC90209-27M07	
50D	1984-87		REC6R5-11633-00	REC90201-23M01			
50G	1993-98	REC6H4-11651-00	REC648-11633-00		REC6G0-11681-00	REC90209-24M03	
50G ETO	2000	REC6E5-11651-00	REC648-11633-00	REC90201-23M01	REC6G0-11681-00	REC90209-24M03	
50G ETOL	2001-06		REC648-11633-00	REC90201-23M01	REC6G0-11681-00	REC90209-24M03	
50H	1994-99	REC6H4-11651-00	REC648-11633-00	REC90201-23M01	REC6G0-11681-00	REC90209-24M03	
50H EDO	2000	REC6H4-11651-00	REC648-11633-00	REC90201-23M01	REC6G0-11681-00	REC90209-24M03	
50H EDOL	2001-02	REC6H4-11651-00	REC648-11633-00	REC90201-23M01	REC6G0-11681-00	REC90209-24M03	
50H EDOS	2001-02	REC6E5-11651-00	REC648-11633-00		REC6G0-11681-00	REC90209-24M03	
50H MDO	2000	REC6E5-11651-00	REC648-11633-00	REC90201-23M01	REC6G0-11681-00	REC90209-24M03	
50H MO	2000		REC648-11633-00	REC90201-23M01	REC6G0-11681-00	REC90209-24M03	
55B	1993-98	REC688-11651-00	REC6R5-11633-00	REC90201-23M01			
70B ETOL	2001-06	REC6E5-11651-00	REC6R5-11633-00	REC90201-23M01			
75A	1993-98	REC688-11651-00	REC6R5-11633-00	REC90201-23M01			
75A E	1990-00	REC688-11651-00	REC6R5-11633-00	REC90201-23M01			
75A EDL	2001-06	REC688-11651-00	REC6R5-11633-00	REC90201-23M01			
75A EM	1992	REC688-11651-00	REC6R5-11633-00	REC90201-23M01			
75A ET	2000	REC688-11651-00					
75A ETL	2001-02	REC688-11651-00					
75A MHD	2000	REC688-11651-00					
75C	1998	REC688-11651-00					
75C ETO	2000	REC688-11651-00					
75C ETOL	2001-06	REC688-11651-00					
80A	1985-96	REC688-11651-00					
85A	1996-98	REC688-11651-00					
85A E	1990-00	REC688-11651-00					
85A ET	2000	REC688-11651-00					
85A ETL	2001-02	REC688-11651-00					
90A	1984-98	REC688-11651-00					
90A ETO	2000-00	REC688-11651-00					
90A ETOL	2001-06	REC688-11651-00					
V4-V6	21.5	REC6E5-11651-00					
E60 ELHB	2003				REC6K5-11681-00		
E60HMHD	2003				REC6K5-11681-00		
225 AET	1986		REC6E5-11633-00				
115 B	1988-90	REC6E5-11650-01	REC6K7-11633-00	REC90201-21M75			
115BE-T	1991-92	REC6E5-11650-01	REC6K7-11633-00	REC90201-21M75			
140 BETO	1988-89	REC6E5-11650-01	REC6K7-11633-00	REC90201-21M75			
150 AETO	1988-89	REC6E5-11650-01	REC6K7-11633-00	REC90201-21M75			
200-225 BETO	1990-92	REC6E5-11650-01	REC6K7-11633-00	REC90201-21M75			
175 BETO	1990-92	REC6E5-11650-01	REC6K7-11633-00	REC90201-21M75			
250A,E 225C	1990-06	REC61A-11650-00					
250B							

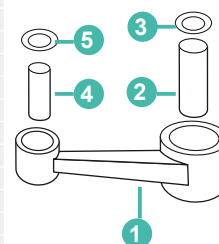

YAMAHA

RECAMBIOS  
MARINOS



# PISTONES

# PISTON

# PISTONE

# PISTONS

2T  
STROKES

## KITS DE PISTONES

La gama de pistones RECMAR®, se suministrará siempre como kit, compuesto por pistón, aros, bulón y clips. Eventualmente las referencias antiguas sufren cambios de numeración. En caso de duda contacten con nuestros técnicos comerciales.

## PISTON KITS





The RECMAR® piston assortment is always supplied as a set (piston, rings, pins and bearings). Old references may change. In case of any doubt contact our technicians.

## KIT PISTONE





La gamma dei pistoni RECMAR®, si vende sempre come kit, composto da pistoni, fasce, bulloni e clips. Le referenze vecchie avranno un cambio di numerazione. In caso di dubbi contattare i nostri tecnici commerciali.





## KIT PISTON

La gamme de pistons RECMAR® sera toujours fournie en kit, comprenant piston, segments, axe et clips. Les anciennes références subissent des modifications de numérotation. En cas de doute, contactez nos technico commerciaux



	STD Ø 50mm	
	REF	OEM
	REC6E0-11631-00-98K	6E0-11631-00-98
	REC6G1-11610-00	6G1-11610-00
	REC6G1-11633-00	6G1-11633-00
	REC93310-112V0	93310-112V0
	REC93450-13022	93450-13022







-  4AC (1985-02)
-  4AS (1987-96)
-  5C (1994-98)
-  5CS (1994-96)



	STD Ø 50mm		0.25		0.50	
	REF	OEM	REF	OEM	REF	OEM
	REC677-11631-00K	677-11631-00-97	REC677-11635-00K	677-11635-00	REC677-11636-00K	677-11636-00
	REC647-11610-00	647-11610-00				
	REC6G1-11633-00	6G1-11633-00	REC6G1-11633-00	6G1-11633-00	REC6G1-11633-00	6G1-11633-00
	REC93602-14118	93602-14118	REC93602-14118	93602-14118	REC93602-14118	93602-14118
	REC93450-13022	93450-13022	REC93450-13022	93450-13022	REC93450-13022	93450-13022







-  E8D (1997-99)
-  E8DMH (1998-03)



	STD Ø 56mm		0.25		0.50	
	REF	OEM	REF	OEM	REF	OEM
	REC6E7-11631-00K	6E7-11631-00	REC6E7-11635-00K	6E7-11635-00	REC6E7-11636-00K	6E7-11636-00
	REC682-11610-01	682-11610-00	REC682-11610-11	682-11610-11	REC682-11610-21	682-11610-21
	REC634-11633-00	634-11633-00	REC634-11633-00	634-11633-00	REC634-11633-00	634-11633-00
	REC93602-14104	93602-14104	REC93602-14104	93602-14104	REC93602-14104	93602-14104
	REC93450-15023	93450-15023	REC93450-15023	93450-15023	REC93450-15023	93450-15023

















-  9.9D/15D (1985-95)
-  9.9F/FMH/MSH (1995-14)
-  15F/FEM/MSH/FMH/MH (1995-14)

	STD Ø 72mm		0.25		0.50	
	REF	OEM	REF	OEM	REF	OEM
	REC6H3-11631-01K	6H3-11631-01-96	REC6H3-11635-01K	6H3-11635-01	REC6H3-11636-01K	6H3-11636-01
	REC6K5-11601-02	6K5-11601-02	REC6K5-11601-12	6K5-11601-12	REC6K5-11601-22	6K5-11601-22
	REC6H3-11633-00	6H3-11633-00	REC6H3-11633-00	6H3-11633-00	REC6H3-11633-00	6H3-11633-00
	REC93603-18M09	93603-18M09	REC93603-18M09	93603-18M09	REC93603-18M09	93603-18M09









-  25B/BETO (1994-95)
-  50G/GEO/GETO (1993-07)
-  60F/FE0/FEDO/FETO/FEH/TR/TLR (1990-07)
-  70BEH/BEO/B/BEM/BETO/BEDO/TR (1990-13)







	STD Ø 72mm		0.25		0.50		
	REF	OEM	REF	OEM	REF	OEM	
	REC61N-11631-00K	61N-11631-00-95	REC61N-11635-00K	61N-11635-00	REC61N-11636-00K	61N-11636-00	
	REC61N-11603-00	61N-11603-00	REC61N-11604-00	61N-11604-00	REC61N-11605-00	61N-11605-00	
	REC689-11633-00	689-11633-00	REC689-11633-00	689-11633-00	REC689-11633-00	689-11633-00	
	REC93602-20M02	93602-20M02	REC93602-20M02	93602-20M02	REC93602-20M02	93602-20M02	
	REC688-11634-00	688-11634-00	REC688-11634-00	688-11634-00	REC688-11634-00	688-11634-00	
	25VE/VM (1996-01) 25B/BMH (2001-10) 30G/GE (1996-00) E30HMH(2003) E30HMH/HW (2003-12)						







	STD Ø 67mm		0.25		0.50		
	REF	OEM	REF	OEM	REF	OEM	
	REC6H4-11631-01K	6H4-11631-01-95	REC6H4-11635-01K	6H4-11635-01	REC6H4-11636-01K	6H4-11636-01	
	REC63D-11603-00	63D-11603-00			REC63D-11605-00	63D-11605-00	
	REC648-11633-00	648-11633-00	REC648-11633-00	648-11633-00	REC648-11633-00	648-11633-00	
	REC93602-20M02	93602-20M02	REC93602-20M02	93602-20M02	REC93602-20M02	93602-20M02	
	REC6H4-11634-01	6H4-11634-01	REC6H4-11634-01	6H4-11634-01	REC6H4-11634-01	6H4-11634-01	
	25Q/QEO (1990-94) 40V/VMH/VETO/VMH/MLH/VMHO/VE/VEO/TLR/VETO/YETO/H/HE (1995-13) C40T/TLR (1995-02) 50H/HRD/HMHD/HETO/HEDO/HWM/D/DE/DEMTO (1989-03)						

	STD Ø 72mm		
	REF	OEM	
	REC689-11631-00K	689-11631-00-95	
	REC689-11610-00	689-11610-01	
	REC689-11633-00	689-11633-00	
	REC93602-20M02	93602-20M02	
	REC663-11634-00	633-11634-00	
	30A (1985-1992)		





	STD Ø 59mm		
	REF	OEM	
	REC6J8-11631-02	6J8-11631-02-97	
	25J/JEO/JETO/ESH (1990-99) 30DETO/DEO/DE/DMH/D/ELH/ DWH (1990-12)		

	STD Ø 76mm		0.25		0.50		
	REF	OEM	REF	OEM	REF	OEM	
	REC6F6-11631-00K	6F6-11631-00-95	REC6F6-11635-00K	6F6-11635-00	REC6F6-11636-00K	6F6-11636-00	
	REC6F5-11610-00	6F5-11610-00	REC6F5-11610-10	6F5-11610-10	REC6F5-11610-20	6F5-11610-20	
	REC6F5-11633-00	6F5-11633-00	REC6F5-11633-00	6F5-11633-00	REC6F5-11633-00	6F5-11633-00	
	REC93603-21111	93603-21111	REC93603-21111	93603-21111	REC93603-21111	93603-21111	
	REC663-11634-00	663-11634-00	REC663-11634-00	663-11634-00	REC663-11634-00	663-11634-00	
	E40GMH/JMH/JWH (2003) 40GWH/JWH (2003)						







	STD Ø 80mm		0.25		0.50		
	REF	OEM	REF	OEM	REF	OEM	
	REC66T-11631-01K	66T-11631-01-93	REC66T-11635-01K	66T-11635-01	REC66T-11636-01K	66T-11636-01	
	REC66T-11603-00	66T-11603-00	REC66T-11604-00	66T-11604-00	REC66T-11605-00	66T-11605-00	
	REC6F5-11633-00	6F5-11633-00	REC6F5-11633-00	6F5-11633-00	REC6F5-11633-00	6F5-11633-00	
	REC93603-21111	93603-21111	REC93603-21111	93603-21111	REC93603-21111	93603-21111	
	REC663-11634-00	663-11634-00	REC663-11634-00	663-11634-00	REC663-11634-00	663-11634-00	
	E40X/XMH/XW (2002-13) 40XMH/XW (2003-13)						

	STD Ø 67mm		0.25		0.50	
	REF	OEM	REF	OEM	REF	OEM
	REC6H4-11631-00K	6H4-11631-00-96	REC6H4-11635-00K	6H4-11635-00	REC6H4-11636-00K	6H4-11636-00
	REC6H4-11610-00-00	6H4-11610-00				
	REC648-11633-00	648-11633-00	REC648-11633-00	648-11633-00	REC648-11633-00	648-11633-00
	REC93602-20M02	93602-20M02	REC93602-20M02	93602-20M02	REC93602-20M02	93602-20M02
	REC6H4-11634-01	6H4-11634-01	REC6H4-11634-01	6H4-11634-01	REC6H4-11634-01	6H4-11634-01
	40N/E/H (1984-1988) 50D/ETN (1984-1988)					







	STD Ø 81mm		0.25		0.50	
	REF	OEM	REF	OEM	REF	OEM
	REC6H1-11631-03K	6H1-11631-03-95				
	REC688-11603-A0	688-11603-A0			REC688-11605-A0	688-11605-A0
	REC663-11633-00	663-11633-00				
	REC93603-21111	93603-21111	REC93603-21111	93603-21111	REC93603-21111	93603-21111
	55B (1996) 75 TLRB (2003) 75CETO (2004-13) 75AE/T/M/HD (1995-98) E75B (2000-02) 75AED (2003-07) 75TLR (2000-02) 80A/AETO/AEMTO (1994-02) 85A/AE (1995-02) 90A/AEO/AEMO/AETO/AET/TLR/AETO (1994-13)					









	STD Ø 82mm	
	REF	OEM
	REC688-11631-02K	688-11631-02-95
	REC688-11610-02	688-11610-02
	REC663-11633-00	663-11633-00
	REC93603-21111	93603-21111
	REC688-11634-00	688-11634-00
	55BET (1990) 55BE (1992)	







	STD	
	REF	OEM
	REC688-11631-81K	688-11631-81-96
	REC688-11610-02	688-11610-02
	REC93603-21111	93603-21111
	75A/AE (1990-93) 85A/AE (1990-93)	









	STD Ø 82mm		0.25		0.50	
	REF	OEM	REF	OEM	REF	OEM
	REC688-11631-03K	688-11631-03-94	REC688-11635-03K	688-11635-03	REC688-11636-03K	688-11635-03
	REC688-11603-A0	688-11603-A0			REC688-11605-A0	688-11605-A0
	REC663-11633-00	663-11633-00	REC663-11633-00	663-11633-00	REC663-11633-00	663-11633-00
	REC93603-21111	93603-21111	REC93603-21111	93603-21111	REC93603-21111	93603-21111
	REC688-11634-00	688-11634-00	REC688-11634-00	688-11634-00	REC688-11634-00	688-11634-00
	E48CMHS (2003) 55B/BM/BET (1993-02) E55CMH (2003-05) E75B (2000) 85A/AET/AED (2000-03)					









	STD Ø 72mm		0.25		0.50	
	REF	OEM	REF	OEM	REF	OEM
	REC6K5-11631-03K	6K5-11631-03-95	REC6K5-11635-03K	6K5-11635-03	REC6K5-11636-03K	6K5-11636-03
	REC6K5-11601-02	6K5-11601-02	REC6K5-11601-12	6K5-11601-12	REC6K5-11601-22	6K5-11601-22
	REC6H3-11633-00	6H3-11633-00	REC6H3-11633-00	6H3-11633-00	REC6H3-11633-00	6H3-11633-00
	REC93603-18M09	93603-18M09	REC93603-18M09	93603-18M09	REC93603-18M09	93603-18M09
	E60HE/HM/H/MHZ/MLHA/ELHB/HMHD -S-L (1997-13)					









	STD Ø 89mm		STD Ø 89mm	
	ESTRIBOR REF	STD   TRIBORDO   DROIT OEM	BABOR   PORT REF	BABORDO   GAUCHE OEM
	REC6R5-11631-11K	6R5-11631-11-93	REC6R5-11642-11K	6R5-11642-11-93
	REC6R5-11603-00	6R5-11603-00	REC6R5-11603-00	6R5-11603-00
	REC6R5-11633-00	6R5-11633-00		
	REC93310-32337	93310-32337	REC93310-32337	93310-32337
	REC6R5-11634-00	6R5-11634-10	REC6R5-11634-00	6R5-11634-10
	100A/AETO (1996-01) 115B (2000-02) 115CEO/CETO/TLR/TXRZ (1993-13) 130BETO/TLR (1993-07) 150 CETO/L150CETO (1993-95)		175BETO (1993-95) 200CETO (1993) 200BETO (1993-95) 225BET/BETO (1993-95)	









	STD Ø 89mm		STD Ø 89mm		0.2590		0.50	
	ESTRIBOR REF	STD   TRIBORDO   DROIT OEM	BABOR   PORT REF	BABORDO   GAUCHE OEM	REF	OEM	REF	OEM
	REC6R5-11631-01K	6R5-11631-11-93	REC6R5-11642-01K	6R5-11642-11-93				
	REC64D-11603-01	64D-11603-02	REC64D-11603-01	64D-11603-02	REC64D-11604-01	64D-11603-04	REC64D-11605-01	64D-11603-05
	REC6K7-11633-00	6K7-11633-00	REC6K7-11633-00	6K7-11633-00				
	REC93310-32337	93603-21111	REC93310-32337	93603-21111				
	REC6R5-11634-00	6R5-11634-00	REC6R5-11634-00	6R5-11634-00				
	115BE/CEO (1992) E115AEL (2003) 130BETO (1992) 150CETO (1992) 175BETO (1992) 200BETO (1992)							



	STD Ø 89mm		STD Ø 89mm	
	ESTRIBOR REF	STD   TRIBORDO   DROIT OEM	BABOR   PORT REF	BABORDO   GAUCHE OEM
	REC6G5-11631-00K	6G5-11631-00-93	REC6G5-11642-00K	6G5-11642-00-93
	REC6E5-11610-02	6E5-11610-02	REC6E5-11610-02	6E5-11610-02
	REC6E5-11633-00	6E5-11633-01	REC6E5-11633-00	6E5-11633-01
	REC93603-21111	93603-21111	REC93603-21111	93603-21111
	REC6E5-11634-00	6E5-11634-00	REC6E5-11634-00	6E5-11634-00
	115ETN (1984) 115A (1985-87) 140AETO (1984-87) 150ETN (1984) 150AETO (1985-87) 175AETO (1984-87) 200ETN (1984) 200AETO (1985-87)			



	STD Ø 89mm		STD Ø 89mm	
	ESTRIBOR REF	STD   TRIBORDO   DROIT OEM	BABOR   PORT REF	BABORDO   GAUCHE OEM
	REC64D-11631-00K	64D-11631-02-90	REC64D-11642-00K	64D-11642-02-90
	REC64D-11603-01	64D-11603-02	REC64D-11603-01	64D-11603-02
	REC6R5-11633-00	6R5-11633-10	REC6R5-11633-00	6R5-11633-10
	REC93310-32337	93310-32337	REC93310-32337	93310-32337
	REC6R5-11634-00	6R5-11634-10	REC6R5-11634-00	6R5-11634-10
	150F/FETO (1996-2007) 150TXR/TR (2002-05) 150AET (2001-02) 175D/DETO (1996-03) 200AET (2003)		200F/TLR/FETO (1996-10) 200G/GETOL (1996-02) L200F/FETO (1996-00) 225D/DET (1996-09)	







**GUÍA DE PISTONES Y SEGMENTOS**



**GUIDE PISTON & RING**



**GUIDA PISTONE E FASCE**

**GUIDE PISTONS ET SEGMENTS**

			
		ESTRIBO   STD TRIBORDO   DROIT	BABOR   PORT BABORDO   GAUCHE
4A	1985-87	REC6G1-11610-00	REC6E0-11631-00-98K
4AC	1987-99	REC6G1-11610-00	REC6E0-11631-00-98K
4ACMHL/HS	2001-03	REC6G1-11610-00	REC6E0-11631-00-98K
4AS	1987-96	REC6G1-11610-00	REC6E0-11631-00-98K
4BC	1998	REC6G1-11610-00	REC6E0-11631-00-98K
4BCMHL/HS	2001-03	REC6G1-11610-00	REC6E0-11631-00-98K
5C	1994-98	REC6G1-11610-00	REC6E0-11631-00-98K
5CMHL/HS	2001-03	REC6G1-11610-00	REC6E0-11631-00-98K
5CS	1994-96	REC6G1-11610-00	REC6E0-11631-00-98K
6C	1984-96	REC6G1-11610-00	
6CMHL/HS	2002	REC6G1-11610-00	
6D	1984-96	REC6G1-11610-00	
6DMHL/HS	2002	REC6G1-11610-00	
8C	1984-96	REC6G1-11610-00	
8CMHL/HS	2002	REC6G1-11610-00	
8CMHX	2002	REC6G1-11610-00	
8CWHL	2002	REC6G1-11610-00	
8CWHS	2002	REC6G1-11610-00	
E8D	1997-98	REC647-11610-00	REC677-11631-00K
E8DMH	1999	REC689-11610-00	REC677-11631-00K
9.9D	1985	REC682-11610-01	REC6E7-11631-00K
9.9FEMHW	1995-13	REC682-11610-01	REC6E7-11631-00K
13.5/15 FEMHW LBC	1995-13	REC682-11610-01	REC6E7-11631-00K
15D	1985-95	REC682-11610-01	REC6E7-11631-00K
25B/BETO	1994-95	REC6K5-11601-02	REC6H3-11631-01K
25BMHL/HS	2001-10	REC61N-11603-00	REC61N-11631-00K
25J	1990-00		REC6J8-11631-02
25Q	1990-94		REC6H4-11631-01K
25VE/VM	1996-01	REC61N-11603-00	REC61N-11631-00K
25BMHL/HM	2001-12	REC61N-11603-00	REC61N-11631-00K
25BMHS/WC	2001-12	REC61N-11603-00	REC61N-11631-00K
C25 MHV2	1997-98	REC61N-11603-00	REC61N-11631-00K
30A	1984-85	REC689-11610-00	REC689-11631-00K
30AM	1990-92	REC689-11610-00	REC689-11631-00K
30D	1990-02		REC6J8-11631-02
30DEOL-EL	2001-10		REC6J8-11631-02
30DEOS	2001-10		REC6J8-11631-02
30DEOT-DETOL	2001-10		REC6J8-11631-02
30DMHOL	2001-14		REC6J8-11631-02
30DMHOS	2001-10		REC6J8-11631-02
E30HMH	2003	REC61N-11603-00	REC61N-11631-00K
30G/GE	1996-97	REC61N-11603-00	REC61N-11631-00K
30 HM/WH	2003	REC61N-11603-00	REC61N-11631-00K
30 HM/W	2010-12	REC61N-11603-00	REC61N-11631-00K
C30	1993-97	REC61N-11603-00	REC61N-11631-00K
40H	1984-88	REC6H4-11610-00-00	REC6H4-11631-00K
40H	1989-94		REC6H4-11631-01K
40RMHO	2000	REC6H4-11610-00-00	REC6H4-11631-01K
40RROS	2001	REC6H4-11610-00-00	REC6H4-11631-01K
40V	1995-98	REC6H4-11610-00-00	REC6H4-11631-01K
40VEO	2000	REC6H4-11610-00-00	REC6H4-11631-01K
40VEOL/OS	2001-06	REC6H4-11610-00-00	REC6H4-11631-01K
40VETO	2000	REC6H4-11610-00-00	REC6H4-11631-01K
40VETOL	2001-06	REC6H4-11610-00-00	REC6H4-11631-01K
40VETOS	2001-3	REC6H4-11610-00-00	REC6H4-11631-01K
40VMHOL/OS	2001-06	REC6H4-11610-00-00	REC6H4-11631-01K
40VMO	2000	REC6H4-11610-00-00	REC6H4-11631-01K
40VMOS	2002	REC6H4-11610-00-00	REC6H4-11631-01K
40X	1998	REC66T-11603-00	REC66T-11631-01K
40XMH	2000	REC66T-11603-00	REC66T-11631-01K
40XMHL	2001-06	REC66T-11603-00	REC66T-11631-01K
40XMHS	2001-02	REC66T-11603-00	REC66T-11631-01K
40XW	2000	REC66T-11603-00	REC66T-11631-01K
40XWL/WS	2001	REC66T-11603-00	REC66T-11631-01K

			
		ESTRIBO   STD TRIBORDO   DROIT	BABOR   PORT BABORDO   GAUCHE
40XWT	2000	REC66T-11603-00	REC66T-11631-01K
40XWTL	2001-03	REC66T-11603-00	REC66T-11631-01K
40YETOL/YMHOS	2001-04	REC6H4-11610-00-00	REC6H4-11631-01K
50D	1984-89	REC6H4-11610-00-00	REC6H4-11631-01K
50D	1989-94		REC6H4-11631-01K
50G/EO	1993-00	REC6K5-11601-02	REC6H3-11631-01K
50GETO	2000	REC6K5-11601-02	REC6H3-11631-01K
50GETOL	2001-07	REC6K5-11601-02	REC6H3-11631-01K
50H	1995-98	REC6H4-11610-00-00	REC6H4-11631-01K
50HEDO	2000	REC6H4-11610-00-00	REC6H4-11631-01K
50HEDOL/OS	2001-02	REC6H4-11610-00-00	REC6H4-11631-01K
50HMDO	2000	REC6H4-11610-00-00	REC6H4-11631-01K
55B	1993-02	REC688-11603-A0	REC6H1-11631-03K
55BE	1990-92	REC688-11610-02	REC688-11631-02K
55BE	2000	REC688-11603-A0	REC688-11631-02K
55BEHD/BET	2000	REC688-11603-A0	REC688-11631-02K
55BETL	2001-02	REC688-11603-A0	REC688-11631-02K
60F	1990-02	REC6K5-11601-02	REC6H3-11631-01K
60FEO	1991-00	REC6K5-11601-02	REC6H3-11631-01K
60FETO	2000-06	REC6K5-11601-02	REC6H3-11631-01K
60FETOL	2001-07	REC6K5-11601-02	REC6H3-11631-01K
E60/HM/HDL	2001-06	REC6K5-11601-02	REC6K5-11631-03K
70B	1990-02	REC6K5-11601-02	REC6H3-11631-01K
70BEDOL	2001-03	REC6K5-11601-02	REC6H3-11631-01K
70BEO	1991-00	REC6K5-11601-02	REC6H3-11631-01K
70BETO	1998-13	REC6K5-11601-02	REC6H3-11631-01K
70BETOL	2001-13	REC6K5-11601-02	REC6H3-11631-01K
75A	1993-94	REC688-11610-02	REC688-11631-81K
75AET	2000	REC688-11603-A0	REC6H1-11631-03K
75AETL	2001-06	REC688-11603-A0	REC6H1-11631-03K
75AMHD	2000	REC688-11603-A0	REC6H1-11631-03K
75C	1998	REC688-11603-A0	REC6H1-11631-03K
75CETO	2000	REC688-11603-A0	REC6H1-11631-03K
75CETOL	2001-06	REC688-11603-A0	REC6H1-11631-03K
80A	1994-96	REC688-11603-A0	REC6H1-11631-03K
85A	1990-94	REC688-11610-02	REC688-11631-81K
85A	1995-98	REC688-11603-A0	REC6H1-11631-03K
85AE	1990-92	REC688-11610-02	REC688-11631-81K
85AE/AET	2000	REC688-11603-A0	REC6H1-11631-03K
85AETL	2001-02	REC688-11603-A0	REC6H1-11631-03K
90A	1994-98	REC688-11603-A0	REC6H1-11631-03K
90AETO	2000	REC688-11603-A0	REC6H1-11631-03K
90AETOL	2001-06	REC688-11603-A0	REC6H1-11631-03K
100A	1997-98	REC64D-11603-01	REC6R5-11631-11K REC6R5-11642-11K
100AETO	2000	REC64D-11603-01	REC6R5-11631-11K REC6R5-11642-11K
100AETOL	2001	REC64D-11603-01	REC6R5-11631-11K REC6R5-11642-11K
115A	1984-87	REC6E5-11610-02	REC6G5-11631-00K REC6G5-11642-00K
115B	1992	REC61U-11601-00	REC6R5-11631-01K REC6R5-11642-01K
115B	1993-96	REC6R5-11603-00	REC6R5-11631-11K REC6R5-11642-11K
115BETO	1997-00	REC64D-11603-01	REC6R5-11631-11K REC6R5-11642-11K
115BETOL	2001-02	REC64D-11603-01	REC6R5-11631-11K REC6R5-11642-11K
115C	1992	REC64D-11603-01	REC6R5-11631-11K REC6R5-11642-11K
115C	1993-96	REC6R5-11603-00	REC6R5-11631-11K REC6R5-11642-11K
115C	1997-98	REC64D-11603-01	REC6R5-11631-11K REC6R5-11642-11K
115CETO	2000	REC64D-11603-01	REC6R5-11631-11K REC6R5-11642-11K
115CETOL	2001-06	REC64D-11603-01	REC6R5-11631-11K REC6R5-11642-11K
115CETOX	2001	REC64D-11603-01	REC6R5-11631-11K REC6R5-11642-11K
E115AWEL	2003-06	REC64D-11603-01	REC6R5-11631-01K REC6R5-11642-01K
130B	1992	REC64D-11603-01	REC6R5-11631-11K REC6R5-11642-11K
130B	1993-96	REC6R5-11603-00	REC6R5-11631-11K REC6R5-11642-11K
130B	1997-98	REC64D-11603-01	REC6R5-11631-11K REC6R5-11642-11K
130BETO	2000	REC64D-11603-01	REC6R5-11631-11K REC6R5-11642-11K
130BETOL	2001-06	REC64D-11603-01	REC6R5-11631-11K REC6R5-11642-11K
130BETOX	2001	REC64D-11603-01	REC6R5-11631-11K REC6R5-11642-11K
L130B	1992	REC61U-11601-00	REC6R5-11631-01K REC6R5-11642-01K
L130B	1993	REC6R5-11603-00	REC6R5-11631-11K REC6R5-11642-11K

					
		ESTRIBOR   STD TRIBORDO   DROIT		BABOR   PORT BABORDO   GAUCHE	
L130B	1997-98	REC64D-11603-01	REC6R5-11631-11K	REC6R5-11642-11K	
L130BETOX	2000-01	REC64D-11603-01	REC6R5-11631-11K	REC6R5-11642-11K	
140A	1985-87	REC6E5-11610-02	REC6G5-11631-00K	REC6G5-11642-00K	
150A	1984-87	REC6E5-11610-02	REC6G5-11631-00K	REC6G5-11642-00K	
150AET	1998-00	REC64D-11603-01	REC64D-11631-00K		
150AETL/ AETX	2001-02	REC64D-11603-01	REC64D-11642-00K		
150C	1992	REC61U-11601-00	REC6R5-11631-01K	REC6R5-11642-01K	
150C	1993-05	REC6R5-11603-00	REC6R5-11631-11K	REC6R5-11642-11K	
150F	1996-01	REC64D-11603-01	REC6G5-11631-00K	REC6G5-11642-00K	
150FETO	1998-00	REC64D-11603-01	REC64D-11631-00K	REC64D-11642-00K	
150FETOL	2001-04	REC64D-11603-01	REC64D-11631-00K	REC64D-11642-00K	
150FETOX	2001-05	REC64D-11603-01	REC64D-11631-00K	REC64D-11642-00K	
D150H	1999-02	REC64D-11603-01	REC64D-11631-00K	REC64D-11642-00K	
L150C	1992	REC61U-11601-00	REC6R5-11631-01K	REC6R5-11642-01K	
L 150C	1993-95	REC6R5-11603-00	REC6R5-11631-11K	REC6R5-11642-11K	
L150F	1996-98	REC64D-11603-01	REC6G5-11631-00K	REC6G5-11642-00K	
L150FETO	2000	REC64D-11603-01	REC64D-11631-00K	REC64D-11642-00K	
L150FETOL/ FETOX	2001	REC64D-11603-01	REC64D-11642-00K	REC64D-11642-00K	
175A	1984-87	REC6E5-11610-02	REC6G5-11631-00K	REC6G5-11642-00K	
175B	1992	REC61U-11601-00	REC6R5-11631-01K	REC6R5-11642-01K	
175BETO/ CETO	1993-95	REC6R5-11603-00	REC6R5-11631-11K	REC6R5-11642-11K	
175D	1996-98	REC64D-11603-01	REC6G5-11631-00K	REC6G5-11642-00K	
175DETO	1996-00	REC64D-11603-01	REC64D-11631-00K		
175DETOX	2001-03	REC64D-11603-01	REC64D-11642-00K		
175DETOX	2001-02	REC64D-11603-01	REC64D-11642-00K		
200A	1984-87	REC6E5-11610-02	REC6G5-11631-00K	REC6G5-11642-00K	
200B	1992	REC64D-11603-01	REC6R5-11631-01K	REC6R5-11642-01K	
200B	1993-95	REC6R5-11603-00	REC6R5-11631-11K	REC6R5-11642-11K	
200F	1996-98	REC64D-11603-01	REC6G5-11631-00K	REC6G5-11642-00K	
200FETO	2000	REC64D-11603-01	REC64D-11631-00K	REC64D-11642-00K	
200FETOL/F	2001-04	REC64D-11603-01	REC64D-11631-00K	REC64D-11642-00K	

					
		ESTRIBOR   STD TRIBORDO   DROIT		BABOR   PORT BABORDO   GAUCHE	
200G	1999	REC64D-11603-01	REC64D-11631-00K	REC64D-11642-00K	
200GETO	2000	REC64D-11603-01	REC64D-11631-00K	REC64D-11642-00K	
200GETOL	2001-03	REC64D-11603-01	REC64D-11631-00K	REC64D-11642-00K	
L200B	1992	REC6R5-11603-00	REC6R5-11631-01K	REC6R5-11642-01K	
L 200B	1993-95	REC6R5-11603-00	REC6R5-11631-11K	REC6R5-11642-11K	
L200F	1996-01	REC64D-11603-01	REC6G5-11631-00K	REC6G5-11642-00K	
L200FETO	1996-00	REC64D-11603-01	REC64D-11631-00K	REC64D-11642-00K	
200FETOL	2001-04	REC64D-11603-01	REC64D-11631-00K	REC64D-11642-00K	
220A, ET, O	1985-87	REC6E5-11610-02			
225B	1993-95	REC6R5-11603-00	REC6R5-11631-11K	REC6R5-11642-11K	
225D	1996-01	REC64D-11603-01	REC6G5-11631-00K	REC6G5-11642-00K	
225DETO	1996-00	REC64D-11603-01	REC64D-11631-00K	REC64D-11642-00K	
225G	1999	REC64D-11603-01	REC64D-11631-00K	REC64D-11642-00K	
225GETO	1999-00	REC64D-11603-01	REC64D-11631-00K	REC64D-11642-00K	
225GETOL	2001-03	REC64D-11603-01	REC64D-11631-00K	REC64D-11642-00K	
L225C	1994-95	REC6R5-11603-00	REC6R5-11631-00K	REC6R5-11642-00K	
250A	1993-95	REC6R5-11603-00	REC6R5-11631-00K	REC6R5-11642-00K	
250AETO	2000	REC64D-11603-01	REC69L-11631-00K	REC69L-11642-00K	
250AETOX	2001-04	REC64D-11603-01	REC69L-11631-00K	REC69L-11642-00K	
250B	1997-98	REC64D-11603-01	REC69L-11631-00K	REC69L-11642-00K	
250BETO	2000	REC64D-11603-01	REC69L-11631-00K	REC69L-11642-00K	
250BETOX	2001	REC64D-11603-01	REC69L-11631-00K	REC69L-11642-00K	
L250AETO	2000-05	REC64D-11603-01	REC69L-11631-00K	REC69L-11642-00K	
L250AETOX	2001-06	REC64D-11603-01	REC69L-11631-00K	REC69L-11642-00K	
L250B	1997-02	REC64D-11603-01	REC69L-11631-00K	REC69L-11642-00K	
L250BETO	2000-03	REC64D-11603-01	REC69L-11631-00K	REC69L-11642-00K	
L250BETOX	2001-03	REC64D-11603-01	REC69L-11631-00K	REC69L-11642-00K	
L250GETOX	2006-10	REC64D-11603-01	REC69L-11631-00K	REC69L-11642-00K	
L250 A	1997-98	REC64D-11603-01	REC69L-11631-00K	REC69L-11642-00K	





## GUÍA CORREAS DE DISTRIBUCIÓN

## GUIDE TIMING BELT

## GUIDA CINGHIE DISTRIBUZIONE

## GUIDE DES COURROIES DE DISTRIBUTION

			REF	OEM
F6A-04/ F6A-05/ F8C-04/ F8C-05/ FT8D-04/ FT8D-05/ F9.9F/ F9.9J/ FT9.9G/ FT9.9L	2000+	60	REC68T-46241-00	68T-46241-00
F8B/ FT9.9A/ F9.9B	1985-06	64	REC6G8-46241-00	6G8-46241-00
F9.9C/ FT9.9D/ F15A	1998-08	68	REC66M-46241-00	66M-46241-00
F15C/ F20B	2007+	80	PAF20-05000003	6AH-46241-00
F20A/ F25A/ FT25B/ F30A/ F40B/ F45A	1998-09	80	REC65W-46241-00	65W-46241-00
F40A/ F50A/ FT50B/ FT50C/ F60A/ FT60B	1995+	106	REC62Y-46241-00	62Y-46241-00
F25D/ FT25F/ F30B/ F40F/ F50F/ FT50G/ FT50J/ F50H/ F60C/ F60F/ FT60D/ FT60G/ F70A	2005+	94	REC6C5-46241-00	6C5-46241-00
F80A/ F80B/ F100A/ F100B/ F100D/ F100F(L)/ F115A	1999+	135	REC67F-46241-00	67F-46241-00
F(L) 150A	2004+	147	REC63P-46241-00	63P-46241-00
F(L) 200A/ F(L) 225A	2002-11	159	REC69J-46241-00	69J-46241-00
F(L) 200C/ F(L) 225B/ F225C/ F(L) 250A/ F(L) 250B	2005+	225	REC6P2-46241-02	6P2-46241-02

# SISTEMA DE ESCAPE Y ADMISIÓN EXHAUST & INTAKE SYSTEM

# SISTEMA DI SCARICO E ASPIRAZIONE SYSTEME D'ÉCHAPPEMENT ET D'ADMISSION

## SISTEMA DE ESCAPE

## EXHAUST SYSTEM

## SISTEMA SCARICO

## SYSTÈME D'ÉCHAPPEMENT

### JUNTAS DEL SISTEMA DE ESCAPE

### EXHAUST GASKETS

### GUARNIZIONE SCARICO

### JOINTS D'ÉCHAPPEMENT

REF	OEM
REC6G1-41133-A0	6G1-41133-A0
	6C/CEM/D/DEM/TRV/MSH/MHS/CWH/DMH/J 8CEM/C/TRV/MSH/MH/CMH/J/N



REF	OEM
PAF25-05080004	65W-14457-10
	F20/25 T25



REF	OEM
PAF15-04010004	66M-41138-00
	F9.9/15/13.5 T9.9



REF	OEM
REC62Y-45127-00	62Y-45127-00
	F20/25/40/45/50 T50



REF	OEM
PAF15-03000003	66M-45115-00
	F9.9/13.5/15 T9.9



REF	OEM
REC62Y-41133-00	62Y-41133-00
	F20/25/40/45/50 T50



REF	OEM
REC682-41133-A0	682-41133-A0
	9.9D E9.9DMH 15D E15DMH



REF	OEM
REC67C-41133-00	67C-41133-00
	F20/25/40/50/30 T25



REF	OEM
REC63V-41133-A1	63V-41133-A1
	9.9F/FEM/FMH/MH/AW/MSH 13.5AWH

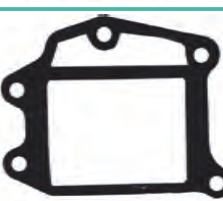

REF	OEM
REC67C-45123-00	67C-45123-00
	F20/25/40/50/30 T25



REF	OEM
REC6L2-41133-A3	6L2-41133-A3
	20D/DEM/DEO/MLH/DMH 25NE/NW/MLH/N/MSH/MH/MLH



REF	OEM	
REC663-45123-00	663-45123-00	
	25QE0 40H/N F40/45/50 50ETN	T50 55B E55CM



REF	OEM
REC6L2-41134-00	6L2-41134-00
	20D/DEM/DEO/MLH/DMH 25NE/NW/MLH/N/MSH/MH/MLH



REF	OEM
REC664-41134-A0	664-41134-A0
	20C/CM/A/G/GE E25A/25VE/VM/DE/D

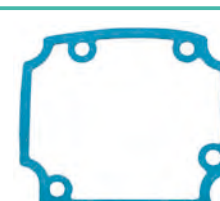

YAMAHA

RECAMBIOS MARINOS

REF	OEM
REC63D-45123-00	63D-45123-00

 25AE0/50H/40V/YE  
C40M/40TLR/50DE



REF	OEM
REC688-41134-00	688-41134-A0

 75A/AE/AED/CETO/TLR  
80A/AEO  
85A/AED-T  
90A/AET/AEO



REF	OEM
REC6H3-45127-00	6H3-45127-00

 25B/BETO  
50G/GEO/GETO  
60FE/FET/FEO/FETO/FEDO  
E60H/MHZ/MLH/HMH/HW





REF	OEM
REC688-45123-00	688-45123-00

 75CETO/TLR  
E75B/AED  
80A/AE/TLR  
85A/AE  
90A/AE/TLR/TR





REF	OEM
REC6H3-45123-00	6H3-45123-00

 25B/BETO  
50G/GEO/GETO  
60FE/FET/FEO/FETO/FEDO  
E60H/MHZ/MLH/HMH/HW  
70B/ETN/  
BEH/BE0/BEM0/BETO/CE





REF	OEM
REC67F-41138-00	67F-41138-00

 F80/100/115



REF	OEM
REC6H4-41134-A0	6H4-41134-A0

 25QEO/50H/40V/YE  
C40M/40TLR/50DE





REF	OEM
REC67F-45127-00	67F-45127-00

 F80/100/115



REF	OEM
REC66T-41133-A1	66T-41133-A0

 40X/XW/XMH  
E40X/MLN



REF	OEM
REC67F-45123-00	67F-45123-00

 F75/80/100





REF	OEM
REC676-41133-A0	676-41133-A0

 40QE/QE-Z/QM/QWC





REF	OEM
REC67F-41134-A0	67F-41134-A0

 F80/100/115





REF	OEM
REC676-45128-00	676-45128-00

 40QE/QE-Z/QM/QWC





REF	OEM
REC68V-45123-00	68V-45123-00

 F80/100/115





REF	OEM
REC676-45127-00	676-45127-00

 40QE/QE-Z/QM/QWC



REF	OEM
REC6E5-41135-A0	6E5-41135-A0

 100A/AET/TLR  
115B/BETO/CEO/CETO/TXR  
130BETO





REF	OEM
REC6E5-41134-A0	6E5-41134-A0

 100A/AET/TLR  
 115B/BETO/CEO/CETO/TXR, 130BETO



REF	OEM
REC6S1-41136-00	6S1-41136-00

 F200/225/250

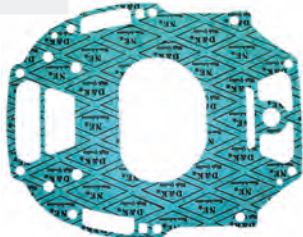

REF	OEM
REC6G5-41134-A1	6G5-41134-A1

 130BETO  
 150FETO/PETO/TR  
 175DETO/GETO/TR  
 Z200  
 200AET/ FETO/NETO/TXR  
 225DET





REF	OEM
REC6AW-41134-01	6AW-41134-00

 FL/F300-350 (2008+)



REF	OEM
REC69J-41138-00	69J-41138-00

 F200/225/250



REF	OEM
REC6A1-14613-A0	6A1-14613-A0, 00, 01

 2B/C/M (1985-10)  
 2T/strokes

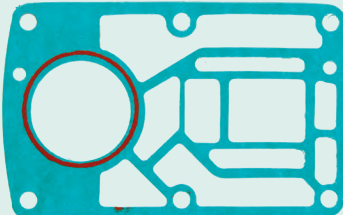

**new**

REF	OEM
REC69J-45123-00	69J-45123-00

 F200/225/250



REF	OEM
REC69J-41135-A0	69J-41135-A0

 F200/225/250

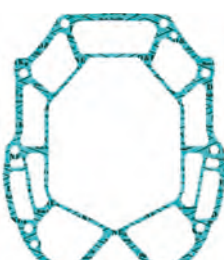

REF	OEM
REC93101-13M27	93101-13M27

 E9.9/E15  
 F9.9/F15 (modelos antiguos | old models | modello vecchio | anciens)



**new**

REF	OEM
REC69J-41134-A0	69J-41134-A0

 F200/225

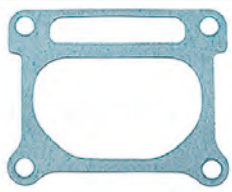

**JUNTAS DE COLECTOR Y CARTER**

**GASKET, UPPERCASING, OIL PAN, MANIFOLD**

**GUARNIZIONI COLLETTORE E CARTER**

**JOINTS DE COLLECTEUR ET CARTER D'HUILE**

REF	OEM
REC646-14623-A1	646-14623-A1

 2B

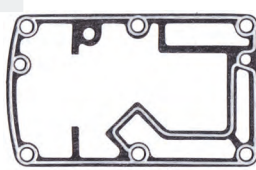

REF	OEM
PAF4-04000002	68D-11351-A0

 F4





REF	OEM
PAF2.6-04000004	69M-11351-A0

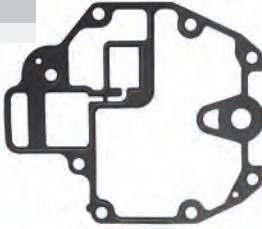

 F2.5

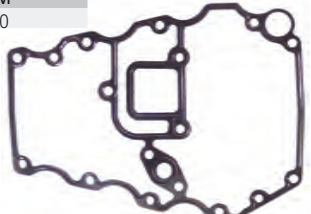



REF	OEM
REC68T-13475-00	68T-13475-00
 F6/8/9.9 T8/9.9	



REF	OEM
REC67C-15312-00	67C-15312-00
 F25/30/40 T25	

REF	OEM
REC6G8-45113-A1	6G8-45113-A1
 F8/9.9 T9.9	



REF	OEM
REC67C-45113-00	67C-45113-00
 F25/30/40 T25	



REF	OEM
REC6AH-13329-00	6AH-13329-00
 F9.9/13.5/15/20	

REF	OEM
REC6H3-45114-A1	6H3-45114-A1
 25B/BETO 50G/GEO/GETO 60FEDO/TLR/BEO E60H/MLHMHM 70B/BEO 70BETO/TR	

REF	OEM
REC682-45113-A0	682-45113-02
 9.9D 15D	



REF	OEM
PAF25-02010007	67C-15312-00
 F25/30/40 T25	

REF	OEM
REC6AH-15312-00	6AH-15312-00
 F9.9/13.5/15/20	

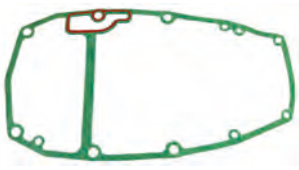
REF	OEM
REC676-45114-A1	676-45114-A1
 40QE/QE-Z/QM/QWC/GWH/JWH E40GMH/JMH	

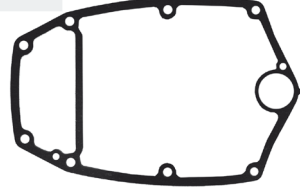
REF	OEM
PAF15-00000005	66M-45113-00
 F15/9.9/13.5 FT9.9	

REF	OEM
REC66T-45114-A0	66T-45114-A0
 40X/XMH/XW E40X/MLH/XMH	

REF	OEM
REC62Y-15312-00	62Y-15312-00
 F20/25/40/45/50 T50	

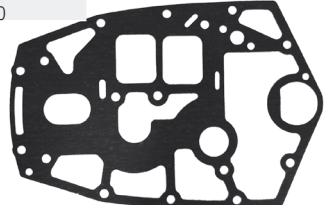
REF	OEM
REC697-45114-00	697-45114-A0
 E48CMH 55BET/B/BE/BM E55CMH	

REF	OEM
REC63D-45114-A0	63D-45114-A0

 50H/HR/HM  
 40V/VM/VETO/C40MLH  
 C40T/TLR  
 40YETO



REF	OEM
REC63P-15312-00	63P-15312-00

 F150/175/200



REF	OEM
REC688-45114-A1	688-45114-A1

 75A/AE/CETO/TLR/AED  
 E75B  
 85A/AED-M-T  
 80A/AE/AEO  
 90A/ETN/AEO/AETO

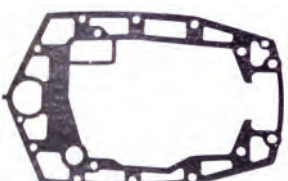

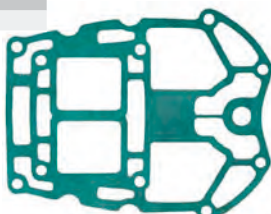

REF	OEM
REC61A-41134-A0	6D0-41134-00

 225C/FETO/G/GETO  
 Z250  
 250B/AET/BETO/TXR  
 Z300/AETO/TR



REF	OEM
REC67F-45113-00	67F-45113-00

 F75/80/100/115



REF	OEM
REC6AW-45113-00	6AW-45113-00

 F300/350

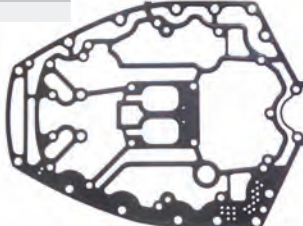

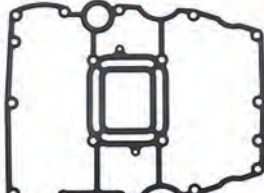

REF	OEM
REC68V-15312-00	68V-15312-00

 F80/100/115





REF	OEM
REC6AW-15312-00	6AW-15312-00

 FL/F300-350 (2008+)





REF	OEM
REC6G5-45114-A0	6G5-45114-A1

 115A/B/ETN/BETO  
 130BETO  
 140AETO/BETO  
 150ETN/AETO/CETO/FETO  
 Z150  
 Z175  
 175AETO  
 200ETN/AET-0  
 Z200  
 225AETO/DET



REF	OEM
REC6AW-15451-00	6AW-15451-00

 FL/F300-350 (2008+)



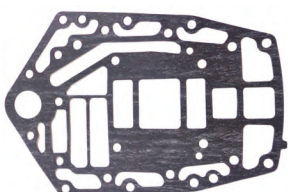

REF	OEM
REC6E5-45114-00	6E5-45114-A0

 115A/ETN  
 E115AEL  
 140AETO



REF	OEM
REC6AW-14613-00	6AW-14613-00

 FL/F300-350 (2008-11)



REF	OEM
REC6AW-14623-00	6AW-14623-00

 FL/F300-350 (2008-11)





# SISTEMA DE ADMISION

# INTAKE SYSTEM

# SISTEMA ASPIRAZIONE

# SYSTEME D'ADMISSION

## JUNTAS DEL SISTEMA DE ADMISION

## GASKETS INTAKE

## GUARNIZIONE SISTEMA ASPIRAZIONE

## JOINTS D'ADMISSION

REF	OEM
REC69J-13645-00	69J-13645-A1

 F200/FL-LF200 (2002-11)  
 F225/LF-FL225 (2002-11)



REF	OEM
REC6G8-15374-00	6G8-15374-00

 F8BE/BM/B  
 F9.9B/BE/BM/A/AM



REF	OEM
REC69J-15451-00	69J-15451-A1

 F200/FL-LF200 (2002-11)  
 F225/LF-FL225 (2002-11)

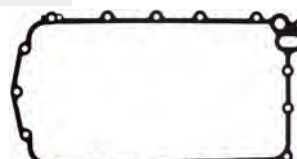

REF	OEM
REC677-24434-02	677-24434-02

 E8D/DMH  
 9.9D/15D  
 25D/NH/NMH/MH/NE/NEMO  
 20DMH/MLH/DW

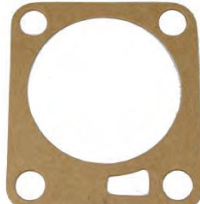

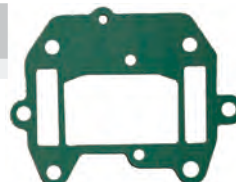

REF	OEM
REC6G1-13645-A1	6G1-13645-A1

 6D/DMH/CMH//MH/C/TRV  
 8C/CMH/MH/MSH





REF	OEM
REC677-13621-00	677-13621-A1

 20CM/C  
 25DE/BMH/B/D/V  
 30A/HM/HW/G/GE  
 E30HMH



REF	OEM
REC6G1-14198-A1	6G1-14198-A1

 6D/DMH/CMH//MH/C/TRV  
 8C/CMH/MH/MSH



REF	OEM
REC677-14198-A1	677-14198-A1

 20CM/C  
 25DE/BMH/B/D/V  
 30A/HM/HW/G/GE  
 E30HMH



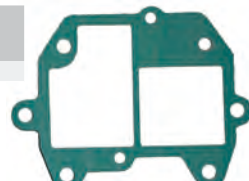

REF	OEM
REC6G1-13621-A1	6G1-13621-A1

 6D/DMH/CMH//MH/C/TRV  
 8C/CMH/MH/MSH





REF	OEM
REC682-13621-00	682-13621-A0

 9.9D  
 15D





REF	OEM
REC6G8-14198-A0	6G8-14198-00

 F8BE/BM/B  
 F9.9B/BE/BM/A/AM





REF	OEM
REC648-13645-A0	648-13645-A0

 20CM/C  
 25DE/BMH/B/D/V  
 30A/HM/HW/G/GE, E30HMH





REF	OEM
REC6G8-13645-00	6G8-13645-00

 F8BE/BM/B  
 F9.9B/BE/BM/A/AM





REF	OEM
REC6G8-13646-A0	6G8-13646-00

 F8BE/BM/B  
 F9.9B/BE/BM/A/AM



REF	OEM
REC648-13621-A0	648-13621-A1

 20CM/C  
 25DE/BMH/B/D/V  
 30A/HM/HW/G/GE  
 E30HMH





REF	OEM
REC648-14198-A0	648-14198-A0

 20C/CM  
 25D/DE  
 30A





REF	OEM
REC6H4-14198-09	6H4-14198-00

 40N/H/E  
 50D/ETN



REF	OEM
REC6H4-14198-01	6H4-14198-01

 25Q/QEO/B  
 50D/G/GEO/GET/H  
 40V/VM/TLR/H  
 C40T/40YET  
 60FEO/FET/D  
 70B/BE



REF	OEM
REC676-13646-A0	676-13646-A0

 40QE/QM/QWC



REF	OEM
REC6L2-13621-00	6L2-13621-00

 25N/M 6L2-6L29, 6L2A - 6L2D  
 (1988-13)

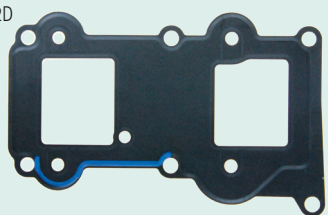



REF	OEM
REC688-14483-A0	688-14483-A0

 E40CMH  
 55B/BE/BET  
 E55CMH





REF	OEM
REC61N-14198-00	61N-14198-00

 25VE/VM/B/BMH/BWH  
 E25A/BMH  
 30G/GE/HMH/HW  
 E30HMH





REF	OEM
REC688-14416-01	688-14416-01

 75AET/AEM/AED  
 E75B  
 85A/AE/AET/AED



REF	OEM
REC6H3-13621-A1	6H3-13621-A1

 25B  
 50G/GEO/GETO,  
 60FEO/FETO/TLR/TRZ/F  
 E60H/E60M  
 70BEO/B/BE/  
 BEDO/BETO/TR



REF	OEM
REC688-13621-A1	688-13621-A1

 75AET/AEM/AED  
 E75B  
 85A/AE/AET/AED



REF	OEM
REC6H3-14198-A1	6H3-14198-A1

 25B  
 50G/GEO/GETO  
 60FEO/FETO/TLR/TRZ/F  
 E60H/E60M  
 70BEO/B/BE/  
 BEDO/BETO/TR





REF	OEM
REC688-14198-A1	688-14198-A2

 Z150P/Q/TLR  
 175G/GET  
 200NETO/N/TR/PET  
 250G/GET/B





REF	OEM
REC6H3-13622-A1	6H3-13622-A1

 25B  
 50G/GEO/GETO  
 60FEO/FETO/TLR/TRZ/F  
 E60H/E60M  
 70BEO/B/BE/BEDO/BETO/TR





REF	OEM
REC6F5-13645-A0	6F5-13645-A1

 40GWH/JWH  
 E40GMH/JMH





REF	OEM
REC6F5-13646-A2	6F5-13646-A1

 40GWH/JWH  
 E40GMH/JMH





REF	OEM
REC6F5-13621-A1	6F5-13621-A1

 40GWH/JWH  
 E40GMH/JMH



REF	OEM
REC6E5-14198-A2	6E5-14198-A2

 100A/TLR  
 115BE/B/CETO/TXR  
 130BETO/TLR  
 150F/FETO/TXR/TR/GETO/A/AETO  
 175DETO/D/FETO  
 225DET/D



REF	OEM
REC6F5-14198-A1	6F5-14198-A1

 40GWH/JWH  
 E40GMH/JMH



REF	OEM
REC6E5-14416-A1	6E5-14416-A1

 115B/BE/BET  
 C115TLR

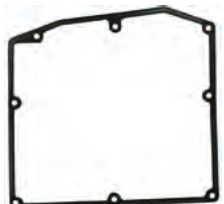



REF	OEM
REC6E9-14198-A0	6E9-14198-A0

 40QE/QM/QWC



REF	OEM
REC6E5-11381-A1	6E5-11381-A1

 115BET/CEO  
 130BET  
 150CET  
 175BET  
 200CETO  
 225BET



REF	OEM
REC663-14483-A0	663-14483-A0

 E40CMH  
 55B/BE/BET  
 E55CMH



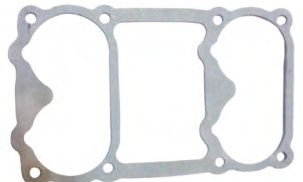

REF	OEM
REC6E5-14483-A1	6E5-14483-A1

 115B/BE/BET  
 C115TLR



REF	OEM
REC663-14198-00	663-14198-A0

 E48CMHS  
 55BET/B/BE/BM



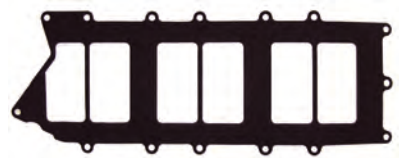

REF	OEM
REC65L-13646-00	65L-13646-00

 150PETO/QETO/TXR  
 175GETO  
 200N/NETO/PET/TLR  
 225G/GET



REF	OEM
REC663-13621-00	663-13621-A0

 E48CMHS  
 55BET/B/BE/BM



REF	OEM
REC6E5-13645-A1-00	6E5-13645-A1

 100A/TLR  
 115BE/B/CETO/TXR  
 130BETO/TLR  
 150F/FETO/TXR/TR/GETO/A/AETO  
 175DETO/D/FETO  
 225DET/D

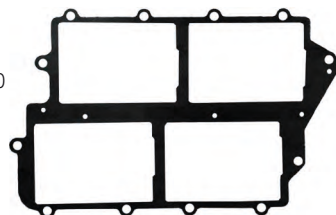

REF	OEM
REC65L-13645-00	65L-13645-00

 150PETO/QETO/TXR  
 175GETO  
 200N/NETO/PET/TLR  
 225G/GET

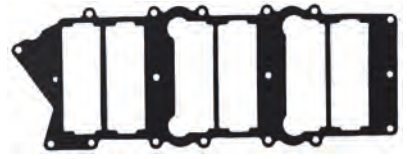

REF	OEM
REC6E5-13621-A1	6E5-13621-A1

 100A/TLR  
 115BE/B/CETO/TXR  
 130BETO/TLR  
 150F/FETO/TXR/TR/GETO/A/AETO  
 175DETO/D/FETO  
 225DET/D



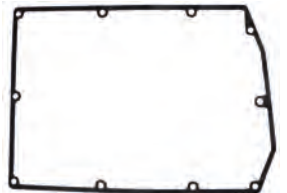

REF	OEM
REC6G5-14416-A1	6G5-14416-A1

 150A-AET





REF	OEM
REC6G5-14483-01	6G5-14483-A1

 150A/AETO  
 175AE/AETO  
 200AET/AETO



REF	OEM
REC61A-13646-00	61A-13646-00

 225C/CET  
 250AET/B/A/ETD



REF	OEM
REC6G5-13645-A1	6G5-13645-A2

 150A/AETO  
 175AE/AETO  
 200AET/AETO

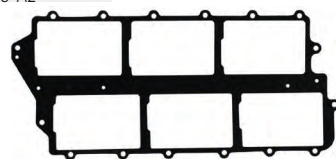

REF	OEM
REC68F-11381-00	68F-11381-00

 Z150  
 VZ150  
 LZ150  
 Z175  
 VZ175

Z200  
 VZ200  
 LZ200



REF	OEM
REC64E-13645-A0	64E-13645-A0

 150GETO  
 D150H 175DET  
 200GETO/G  
 225D/DET



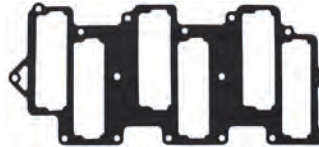

REF	OEM
REC6K7-13645-A2	6K7-13645-A2

 200CETO  
 225BET



REF	OEM
REC61A-13621-A0	61A-13621-A0

 Z150P/Q/TLR  
 175G/GET  
 200NETO/N/TR/PET  
 250G/GET/B



REF	OEM
REC6K7-13646-A2	6K7-13646-A2

 200CETO  
 225BET

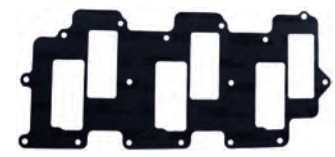

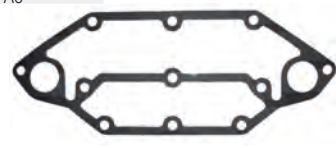

REF	OEM
REC61A-11381-A0	61A-11381-A0

 225C/CET/FET/G/GET  
 250AET/B





REF	OEM
REC60V-13621-A0	60V-13621-A0

 Z300AETO/TR  
 Z250DETO/TR/FETO  
 LZ250 (2003-07)  
 LZ300 (2004-07)  
 VZ200 (2005-09)  
 VZ225 (2003-09)  
 VZ300 (2004-09)  
 VZ250 (2003-07)  
 Z300 (2004-07)





REF	OEM
REC61A-13645-00	61A-13645-00

 225C/CET  
 250AET/B/A/ETD



REF	OEM
REC60V-13645-00	60V-13645-00

 Z300AETO/TR  
 Z250DETO/TR/FETO  
 LZ250 (2003-07)  
 LZ300 (2004-07)  
 VZ200 (2005-09)  
 VZ225 (2003-09)  
 VZ300 (2004-09)  
 VZ250 (2003-07)  
 Z300 (2004-07)



# UNIDADES DE TRANSMISIÓN UNIT DRIVES & COMPONENTS

# UNITÀ DI TRASMISSIONE EMBASES ET PIECES

## COLA COMPLETA

## COMPLETE GEARCASE ASSY

## PIEDI COMPLETI

## EMBASE COMPLETE

4T  
STROKES

### COLAS DE 4 TIEMPOS

### 4 STROKES GEARCASE

### PIEDI 4 TEMPI

### EMBASES DE MOTEUR 4T

REF	OEM		REDUCCIÓN GEAR RATIO RIDUZIONE REDUCTION
PAF2.6-03020000S	69M-65300-01-4D	17"	2.08
PAF2.6-03020000L	69M-65300-11-4D	22"	2.08

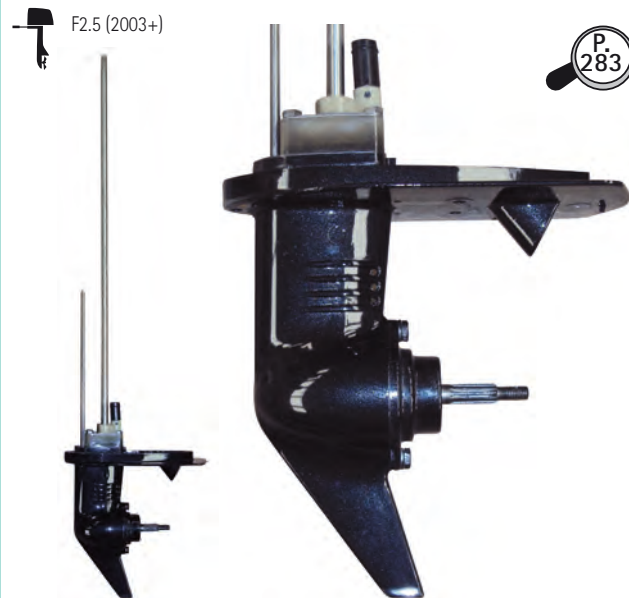

REF	OEM		REDUCCIÓN GEAR RATIO RIDUZIONE REDUCTION
PAF15-06100000S	66M-45300-02-4D	17.3"	2.08
PAF15-06100000L	66M-45300-11-4D	22.3"	2.08



REF	OEM		REDUCCIÓN GEAR RATIO RIDUZIONE REDUCTION
PAF4-03100000S	68D-65300-03-4D	17.1"	2.08
PAF4-03100000L	68D-65300-11-4D	22.1"	2.08



REF	OEM		REDUCCIÓN GEAR RATIO RIDUZIONE REDUCTION
PAF20-04000000S	6AH-45300-00-4D 6AH-45300-00-8D	17.1"	2.08
PAF20-04000000L	6AH-45300-10-4D 6AH-45300-10-8D	22.1"	2.08



YAMAHA

RECAMBIOS  
MARINOS



REF	OEM		REDUCCIÓN GEAR RATIO RIDUZIONE REDUCTION
PAF25-04090000S	65W-45300-01-4D	16.6"	2.08
PAF25-04090000L	65W-45300-01-4D	21.6"	2.08

F20 (1998-2003)  
F25 (1998+)

P. 294

new

REF	OEM		REDUCCIÓN GEAR RATIO RIDUZIONE REDUCTION
PAF60-04000000	69W-45300-00-4D 69W-45300-00-8D 69W-45300-01-8D	20"	1.85

F40D/H (2006+)  
F50F/H/T (2005+)  
F60A/B/C/T (2002+)

P. 310

STD	CONTRAROTACIÓN COUNTERROTATION CONTROROTANTE CONTRE ROTATION	OEM		REDUCCIÓN GEAR RATIO RIDUZIONE REDUCTION
REC416-B20F		63P-45300-00-8D	20" V6 90°	2.0:1
REC416-B25F		63P-45300-10-8D	25" V6 90°	2.0:1
	REC418-B25F	64P-45300-10-8D	25" V6 90°	2.0:1

20" --> F150HP  
25" --> LF150 HP  
V6

P. 326

P. 326

DUAL WATER PICKUP

STD	CONTRAROTACIÓN COUNTERROTATION CONTROROTANTE CONTRE ROTATION	OEM		REDUCCIÓN GEAR RATIO RIDUZIONE REDUCTION
REC422-B25F		6P2-45300-20-8D 6P2-45300-21-8D 6P2-45300-40-8D 6P2-45300-41-8D 6P3-45300-40-8D	25"	2.00:1
	REC429-B25F	6P3-45300-41-8D 6P3-45300-42-8D	25"	2.00:1

F200  
F250

P. 336

new

P. 336

STD	CONTRAROTACIÓN COUNTERROTATION CONTROROTANTE CONTRE ROTATION	OEM		REDUCCIÓN GEAR RATIO RIDUZIONE REDUCTION
REC421-B25F		69J-45300-21-8D	25" V6 76°	2.0:1
REC421-B30F		69J-45300-32-8D	30" V6 76°	2.0:1
	REC428-B25F	69K-45300-21-8D	25" V6 90°	2.0:1
	REC428-B30F	69K-45300-34-8D	30" V6	2.0:1

P. 330

F200 HP  
F225 HP

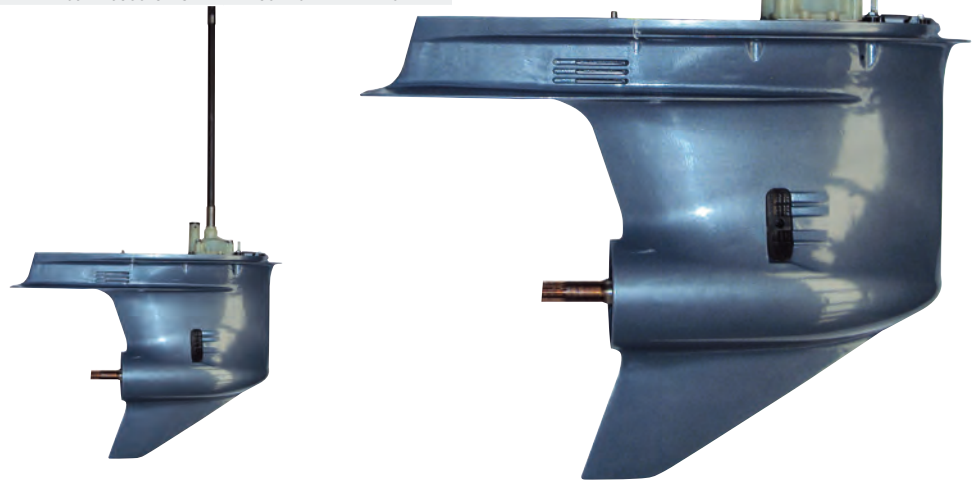

2T  
STROKES

COLAS DE 2 TIEMPOS    2 STROKES GEARCASE    PIEDI 2 TEMPI    EMBASES DE MOTEUR 2 TEMPS

REF	OEM		REDUCCIÓN GEAR RATIO RIDUZIONE REDUCTION
REC63V-45300-13-8D	63V-45300-13-8D		
	63V-45300-13-4D	L 22.3"	2.08
	63V-45300-10-4D		
REC63V-45300-03-8D	63V-45300-03-8D		
	63V-45300-03-4D	S 17.3"	2.08
	63V-45300-00-4D		

9.9 /15 HP (63V Et 63W) (1995+)  
13.5 HP (66S)

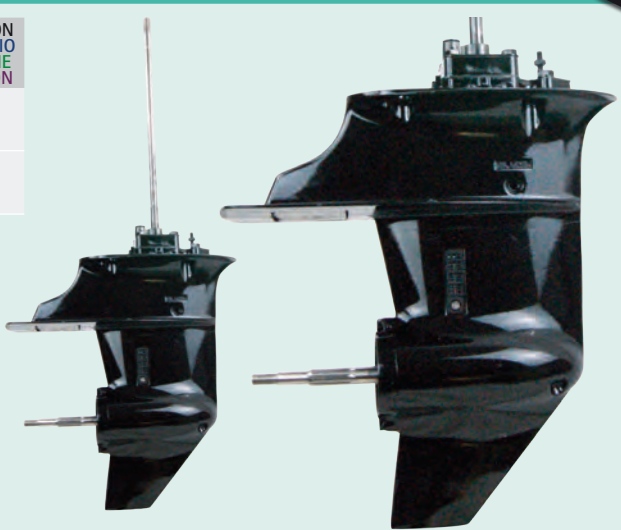

new

P. 350

REF	OEM		REDUCCIÓN GEAR RATIO RIDUZIONE REDUCTION
PAF40-04000000L	66T-45300-10-4D 66T-45311-13-8D	20"	2.08

(E)40X/M (1998-09)

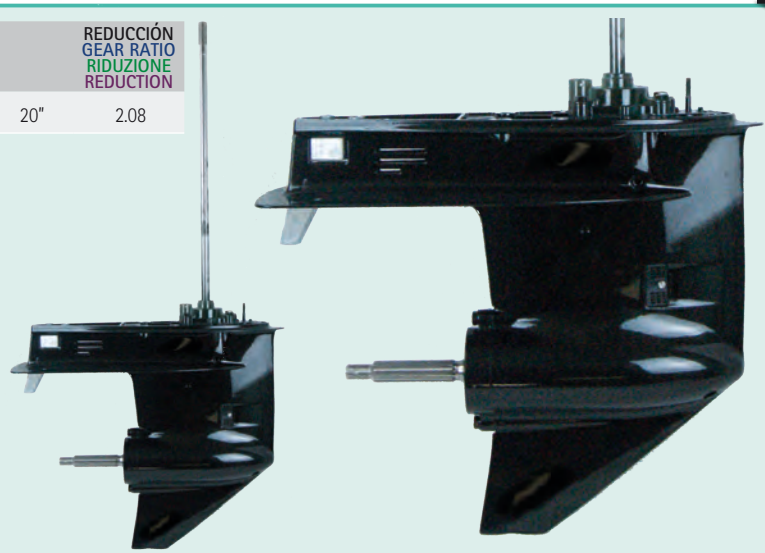

new

P. 360

YAMAHA

RECAMBIOS  
MARINOS

REF	OEM	
REC692-45300-16-8D	692-45300-16-8D	L
	692-45300-14-4D	
	692-45300-13-4D	
	692-45300-12-4D	

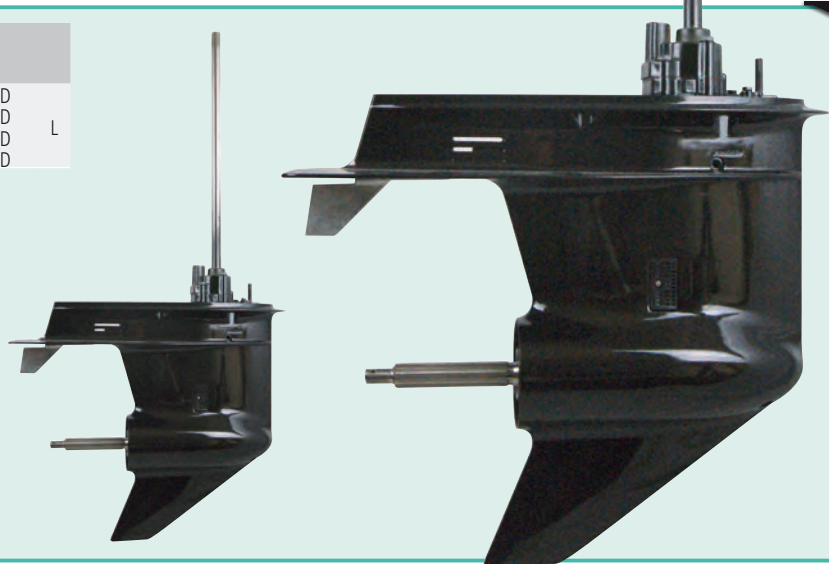

 75A (692) (1995-09)  
 85A (688) (1995-09)



**new**

**P. 370**

STD	OEM		REDUCCIÓN GEAR RATIO RIDUZIONE REDUCTION
REC405-A20	6E5-45300-17-8D	20° V4	2.0:1
REC405-A25	6E5-45300-27-8D	25° V4	2.0:1

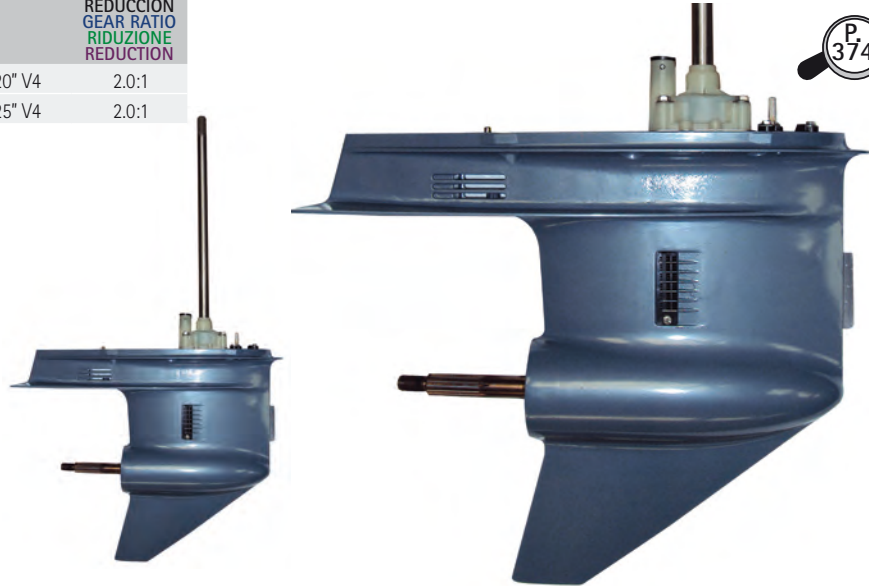

 115HP (1984+)  
 130HP (1987+)



**P. 374**

STD	CONTRAROTACIÓN COUNTERROTATION CONTROROTANTE CONTRE ROTATION	OEM		REDUCCIÓN GEAR RATIO RIDUZIONE REDUCTION	
REC416-A20		64D-45300-01-8D	20° V6 90° 2.6L	1.86:1	
REC416-A25		64D-45300-21-8D	25° V6 90° 2.6L	1.86:1	
		REC418-A25	64P-45300-10-8D	25° V6 90° 2.6L	1.86:1

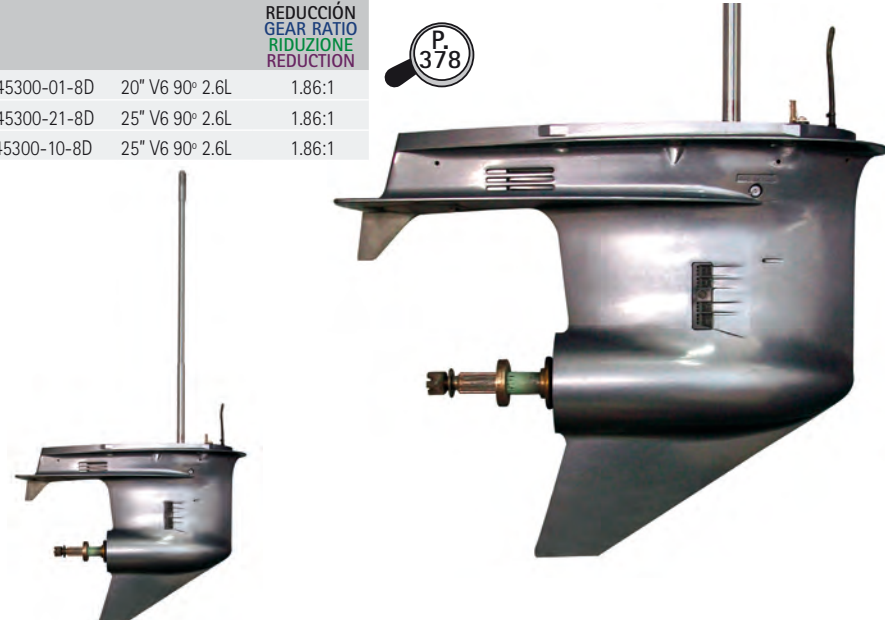

 150HP (1984+)  
 175HP (1984+)  
 200HP (1984+)  
 225HP (1990+)



**P. 378**

STD	OEM		REDUCCIÓN GEAR RATIO RIDUZIONE REDUCTION
REC416-B20	64K-45300-02-NA	20" V6 90° 2.6L	2.0:1

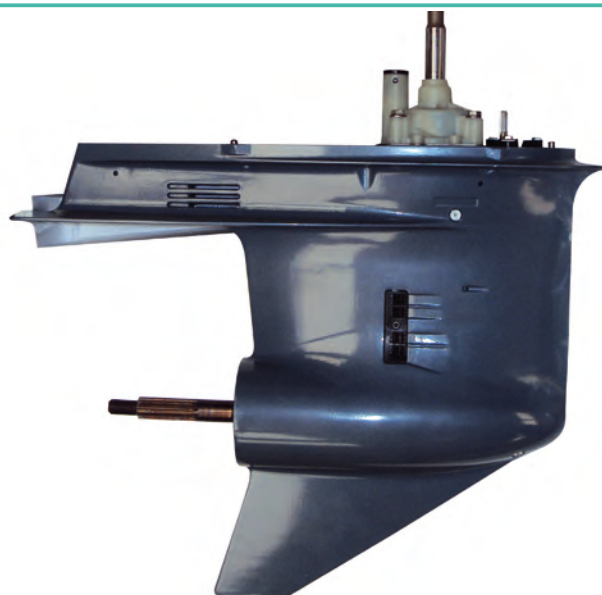
 150HP (1987+)  
 175HP (1989+)  
 200HP (1989+)  
 225HP (1992+)



STD	CONTRAROTACIÓN COUNTERROTATION CONTROROTANTE CONTRE ROTATION	OEM		REDUCCIÓN GEAR RATIO RIDUZIONE REDUCTION	
REC421-A20		66K-45300-12-NA	20" V6 76° 3.1L / 3.2 L	1.81	
REC421-A25		60V-45300-20-8D	25" V6 76°	1.81	
		REC428-A25	60W-45300-20-8D	25" V6 90° 3.1L / 3.2 L	1.81

 V6  
 250D / DETO / DETOX / TR / TXR

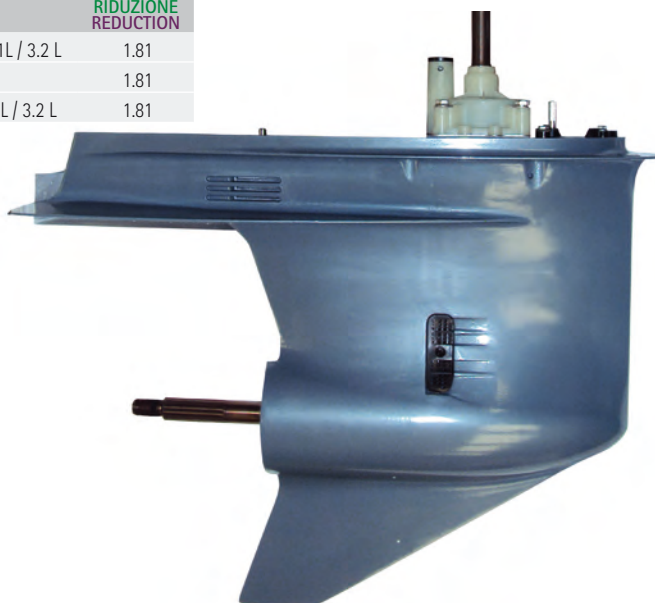



DESPIECE COLAS  
4 TIEMPOS

GEAR CASE PARTS  
4 STROKES

PARTI PIEDI  
DE 4 TEMPI

PIECES D'EMBASES  
DE 4 TEMPS

4T F2.5 (2003+)  
STROKES

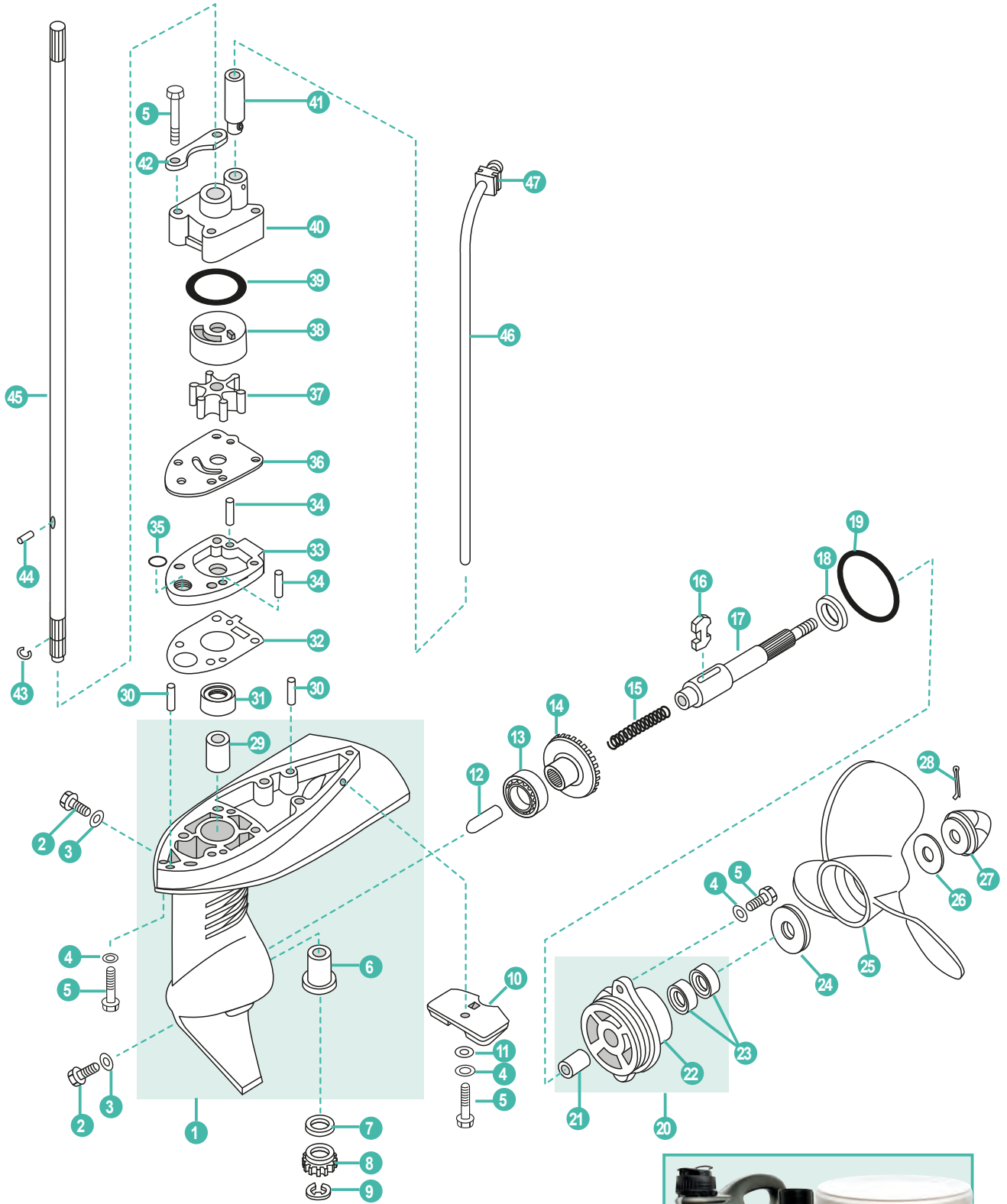

YAMAHA

RECAMBIOS  
MARINOS

	REF	OEM				
	PAF2.6-03020000L	69M-G5300-01-4D	COLA COMPLETA L	COMPLETE GEAR HOUSING L	PIEDE COMPLETO L	EMBASE COMPLETE L
	PAF2.6-03020000S	69M-G5300-00-4D	COLA COMPLETA S	COMPLETE GEAR HOUSING S	PIEDE COMPLETO S	EMBASE COMPLETE S
1	PAF2.6-03000001	69M-G5311-00-4D	CARCASA	LOWER CASING	CARASSA	CARTER D'EMBASE
2	REC90340-08002	90340-08002	TAPÓN ACEITE	PLUG, OIL	TAPPO OLIO	BOUCHON REMPLISSAGE D'HUILE
3	REC90430-08020	90430-08020	JUNTA	GASKET	GUARNIZIONE	JOINT
4	PAGB/T97.1-8	97595-06520	ARANDELA	WASHER	RONDELLA	RONDELLE
5	PAGB/T5783-M5X12	95895-06020	TORNILLO	BOLT	VITE	VIS
6	PAF2.6-03000002	6L5-45317-09	COJINETE	BEARING	CUSCINETTO	PALIER
7	PAF2.6-03000017	6L5-45533-00-20	GRUESO (2.0mm)	SHIM (2.0mm)	SPESSORE (2.0mm)	CALE (2.0mm)
8	PAF2.6-03000018	6L5-45551-00	PIÑÓN ATAQUE	INITIATIVE GEAR	PIGNONE	PIGNON D'ATTAQUE
9	PAGB/T896-86	99001-06600	CIRCLIP	CIRCLIP	CIRCLIP	CIRCLIP
10	PAF4-03000022	68D-G5251-00	ÁNODO	ANODE	ANODO	ANODE
11	PAGB/T861.1-87	92990-06300	ARANDELA	WASHER	RONDELLA	RONDELLE
12	PAF2.6-03000020	69M-G5635-00	TAPÓN CAMBIO	PLUG, SHIFT	TAPPO	BOUCHON
13	PANTN16003EY	93316-003Y0	COJINETE	BEARING	CUSCINETTO	PALIER
14	PAF2.6-03000019	6L5-45560-00	PIÑÓN MARCHA AVANTE	POSITIVE GEAR ASSY	PIGNONE MARCIA AVANTI	PIGNON DE MARCHÉ AVANT
15	PAF4-03030003	90501-10064	MUELLE	SPRING, CLUTCH BLOCK	MOLLA	RESSORT
16	PAF2.6-03000202	6L5-45631-00	SELECTOR	CLUTCH BLOCK	SELETTORE	SELECTEUR
17	PAF2.6-03000201	6L5-45631-00	EJE HÉLICE	SHAFT, PROPELLER	ASSE ELICA	ARBRE D'HELICE
18	PAF2.6-03000021	90201-13198	ARANDELA	WASHER	RONDELLA	RONDELLE
19	PAJISB2401P48	93210-48214	TÓRICA	O-RING	O-RING	JOINT TORIQUE
20	PAF2.6-03000300	69M-G5361-00-4D	TAPA CARTER COMPLETA	COVER ASSY, LOWER CASING	COPERCHIO DE CARTER COMPLETO	DIABOLO COMPLET
21	PAF2.6-03000302		COJINETE CAMISA	BEARING, SLEEVE	CUSCINETTO ASSE	BAGUE
22	PAF2.6-03000301	69M-G5361-00-4D	TAPA CARTER	COVER, LOWER CASING	COPERCHIO CARTER	DIABOLO
23	PAF4-03050002	93101-13M12	RETÉN DE ACEITE	OIL SEAL	PARAOLIO	JOINT SPI
24	PAF4-03000025	68D-G5978-00	ESPACIADOR	SPACER	SPESSORE	ENTRETOISE
25	PAF2.6-03010000	6L5-45943-00-EL	HÉLICE	PROPELLER ASSY	ELICHE	HELICE
26	PAF4-03000026	90201-08M54	ARANDELA	WASHER	RONDELLA	RONDELLE
27	PAF4-03080000	6L5-45616-00	TUERCA	LOCK NUT	DADO	ÉCROU
28	PAGB/T91-1.6X12	91490-25030	PASADOR ALETAS	PIN, COTTER	SPINOTTO	LEVIER
29	PAF2.6-03000003	6L5-45316-09	COJINETE	BEARING	CUSCINETTO	PALIER
30	PAF15-00000013	93604-12M07	PASADOR	PIN	SPINOTTO	LEVIER
31	PAF2.6-03000004	93103-09M41	RETÉN DE ACEITE	OIL SEAL	PARAOLIO	JOINT D'HUILE
32	PAF2.6-03000007	69M-G5315-A0	JUNTA	GASKET, WATER PUMP	GUARNIZIONE	JOINT
33	PAF2.6-03000008	69M-G5321-00-94	CUERPO BOMBA	HOUSING, WATER PUMP	CORPO POMPA ACQUA	CORPS DE POMPE À EAU
34	PAF4-03000013	93604-18080	PASADOR	PIN	SPINOTTO	LEVIER
35	PAF2.6-03000009	93210-05001	TÓRICA	O-RING	O-RING	JOINT TORIQUE
36	PAF2.6-03000010	69M-G4323-00	PLACA	OUT PLATE	PIASTRA	PLAQUE
37	PAF2.6-03000100	6L5-44352-00	TURBINA	IMPELLER	GIRANTE	TURBINE
38	PAF2.6-03000015	6L5-44322-00	TAPA BOMBA AGUA	COVER, INNER WATER PUMP	TAPPO	COUVERCLE DE POMPE D'EAU
39	PAJASOF404-19-033	93210-33M85	TÓRICA	O-RING	O-RING	JOINT TORIQUE
40	PAF2.6-03000014	69M-G4311-00	CUERPO BOMBA	WATER PUMP HOUSING	CORPO POMPA ACQUA	CORPS DE POMPE À EAU
41	PAF4-03000021	6R0-44366-00	TUBO BOMBA AGUA	RUBBER TUBE, WATER PUMP	TUBO POMPA ACQUA	TUBE DE POMPE À EAU
42	PAF2.6-03000016	69M-G4328-00	PLATO BOMBA DE AGUA	PLATE, WATER PUMP FIXED	PIASTRA	PLAQUE, POMPE D'EAU
43	PAF2.6-03000012	93440-08819	CIRCLIP	CIRCLIP	CIRCLIP	CIRCLIP
44	PAF2.6-03000013	93604-07M13	PASADOR	PIN	SPINOTTO	LEVIER
45	PAF2.6-03000011S	69M-G5511-00	EJE VERTICAL S	DRIVE SHAFT S	ASSE VERTICALE S	ARBRE DE COMMANDE S
	PAF2.6-03000011L	69M-G5511-10	EJE VERTICAL L	DRIVE SHAFT L	ASSE VERTICALE L	ARBRE DE COMMANDE L
46	PAF2.6-02000003S	69M-44361-00	TUBO DE AGUA S	WATER TUBE S	TUBO DELL'ACQUA S	DURITE D'EAU S
	PAF2.6-02000003L	69M-44361-10	TUBO DE AGUA L	WATER TUBE L	TUBO DELL'ACQUA L	DURITE D'EAU L
47	PAF4-02040002	68D-G4365-00	GOMA DEL TUBO DE AGUA	I-SHAPED RUBBER BAND	GOMMA TUBO ACQUA	PLOT CAOUTCHOUC DE TUBE D'EAU

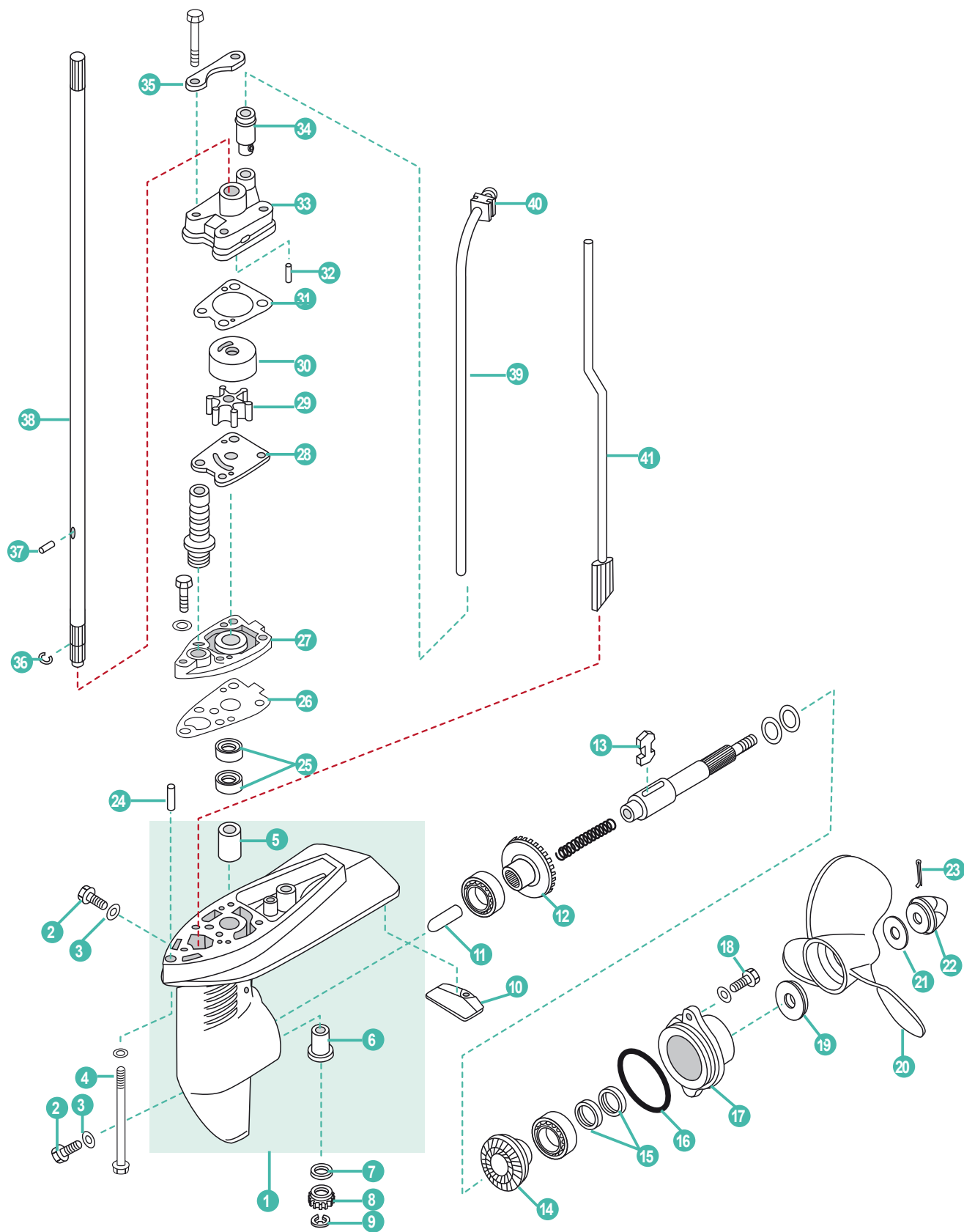

	REF	OEM				
	PAF4-0310000L	68D-G5300-10-4D	COLA COMPLETA L	COMPLETE GEAR HOUSING L	PIEDE COMPLETO L	EMBASE COMPLETE L
	PAF4-0310000S	68D-G5300-00-4D	COLA COMPLETA S	COMPLETE GEAR HOUSING S	PIEDE COMPLETO S	EMBASE COMPLETE S
1	PAF4-03000001	68D-G5300-11-4D	CARCASA MOTOR	CRANK CASE	CARCASSA	CARTER D'EMBASE
2	REC90340-08002	90340-08002	TAPÓN ACEITE	PLUG, OIL	TAPPO OLIO	BOUCHON REMPLISSAGE D'HUILE
3	REC90430-08020	90430-08020	JUNTA	GASKET	GUARNIZIONE	JOINT
4	PAGB/T5782-M6X125	97013-06035	TORNILLO HEXAGONAL L	HEXAGON BOLT L	VITE L	VIS L
	PAGB/T5782-2000S	PAGB/T5782-2000S	TORNILLO HEXAGONAL S	HEXAGON BOLT S	VITE S	VIS S
5	PAF4-03000003	6E0-45316-09	RODAMIENTO	BALL BEARING	CUSCINETTO	ROULEMENT À BILLE
6	PAF4-03000002	6E0-45317-09	COJINETE	BEARING	CUSCINETTO	PALIER
7	PAF4-03000006	90204-11M49	ARANDELA	WASHER	RONDELLA	RONDELLE
8	PAF4-03000007	6E0-45551-00	PIÑÓN ATAQUE	INITIATIVE GEAR	MARCIA INIZIATIVA	PIGNON D'ATTAQUE
9	PAGB/T896-86	99001-06600	CIRCLIP	CIRCLIP	CIRCLIP	CIRCLIP
10	PAF4-03000022	68D-G5251-00	ÁNODO	ANODE	ANODO	ANODE
11	PAF4-03000008	67D-45635-00	ÉMBOLO	PLUGER, SHIFT	BULLONE	BOUCHON
12	PAF4-03010000	67D-45560-00	PIÑÓN MARCHA AVANTE	POSITIVE GEAR ASSY	PIGNONE MARCIA AVANTI	PIGNON DE MARCHE AVANT
13	PAF4-03030002	67D-45631-01	SELECTOR	CLUTCH BLOCK	SELETTORE	SELECTEUR
14	PAF4-03040000	67D-45570-00	PIÑÓN MARCHA ATRÁS	REVERSE GEAR	PIGNONE MARCIA INDIETRO	PIGNON MARCHE ARRIÈRE
15	PAF4-03050002	93101-13M12	RETÉN DE ACEITE	OIL SEAL	PARAOLIO	JOINT SPI
16	PAJISB2401P48	93210-48214	TÓRICA	O-RING	O-RING	JOINT TORIQUE
17	PAF4-03050001	68D-G5361-00-4D	TAPA CÁRTER	COVER, LOWER CASING	TAPPO CARTER	DIABOLO
18	PAGB/T5783-M5X12	95895-06016-00	TORNILLO HEXAGONAL	HEXAGON BOLT	VITE ESSAGONALE	VIS HEXAGONAL
19	PAF4-03000025	68D-G5987-00	ESPACIADOR	SPACER	DISTANZIALE	ENTRETOISE
20	PAF4-03070000	6E0-45943-01-EL	HÉLICE	PROPELLER	ELICHE	HELICE
21	PAF4-03000026	90201-08M54	ARANDELA INOX.	WASHER, STAINLESS STEEL	RONDELLA INOX.	RONDELLE INOX
22	PAF4-03080000	6L5-45616-00	TUERCA	LOCK NUT	DADO	ÉCROU
23	PAGB/T91-1.6X12	91490-25030	PASADOR ALETAS	PIN, COTTER 2.5x30	PIN	PIN
24	PAF4-00000001	90387-06806	PASADOR VACÍO	HOLLOW PIN	SPINOTTO	GUIDE
25	PAF4-03000027	93101-10M14	RETÉN DE ACEITE	OIL SEAL	PARAOLIO	JOINT SPI
26	PAF4-03000011	68D-G5315-A0	JUNTA HERMÉTICA BASE	HERMETIC GASKET, WATER PUMP BASE	GUARNIZIONE BASE POMPA ACQUA	JOINT DE BASE DE POMPE À EAU
27	PAF4-03000012	68D-G5321-00	BASE BOMBA AGUA	BASE, WATER PUMP	BASE POMPA	BASE DE POMPE À EAU
28	PAF4-03000015	6E0-44323-00	PLACA	OUT PLATE	PIASTRA	PLAQUE
29	PAF4-03060000	6E0-44352-00	TURBINA BOMBA AGUA	IMPELLER, WATER PUMP	GIRANTE POMPA	TURBINE, POMPE D'EAU
30	PAF4-03000017	6E0-44322-02	TAPA, BOMBA AGUA	COVER, INNER WATER PUMP	COPERCHIO, POMPE D'EAU	COUVERCLE, POMPE D'EAU
31	PAF4-03000018	68D-G4315-A0	JUNTA TAPA BOMBA AGUA	GASKET, WATER PUMP COVER	GUARNIZIONE COPERCHIO	JOINT COUVERCLE
32	PAF4-03000013	93604-18080	PASADOR BOMBA AGUA	PIN, WATER PUMP	SPINOTTO POMPA ACQUA	LEVIER POMPE D'EAU
33	PAF4-03000019	68D-G4311-01	CUERPO BOMBA AGUA	HOUSING, WATER PUMP	CORPO POMPA	LOGEMENT POMPE D'EAU
34	PAF4-03000021	67D-44366-00	TUBO GOMA BOMBA AGUA	RUBBER TUBE, WATER PUMP	TUBO IN GOMMA, POMPA	DURITE DE COUTCHOU
35	PAF4-03000020	68D-G4328-00	PLCA BOMBA AGUA	PLATE, WATER PUMP FIXED	PIASTRA POMPA	PLAQUE, POMPE D'EAU
36	PAF4-03000005	90467-08M01	CLIP	CLIP	CLIP	CLIP
37	PAF4-03000016	93604-09066	PASADOR	PIN	SPINOTTO	LEVIER
38	PAF4-03000004L	6E0-45511-11	EJE VERTICAL S	DRIVE SHAFT S	ASSE VERTICALE S	ARBRE DE COMMANDE S
	PAF4-03000004S	6E0-45511-01	EJE VERTICAL L	DRIVE SHAFT L	ASSE VERTICALE L	ARBRE DE COMMANDE L
39	PAF4-02040001	68D-G4360-10	TUBO DE AGUA S	WATER TUBE S	TUBO DELL'ACQUA S	DURITE D'EAU S
	PAF4-02040001S	68D-G4360-00	TUBO DE AGUA L	WATER TUBE L	TUBO DELL'ACQUA L	DURITE D'EAU L
40	PAF4-02040002	68D-G4365-00	GOMA DEL TUBO DE AGUA	I-SHAPED RUBBER BAND	GOMMA TUBO ACQUA	PLOT CAOUTCHOU DE TUBE D'EAU
41	PAF4-03020000L	68D-G4150-10	VARILLA SELECTOR L	CAM ASSY, SHIFT ROD L	ASTICELLA CAMBIO L	LEVIER DE VITESSE L
	PAF4-03020000S	68D-G4150-00	VARILLA SELECTOR S	CAM ASSY, SHIFT ROD S	ASTICELLA CAMBIO S	LEVIER DE VITESSE S

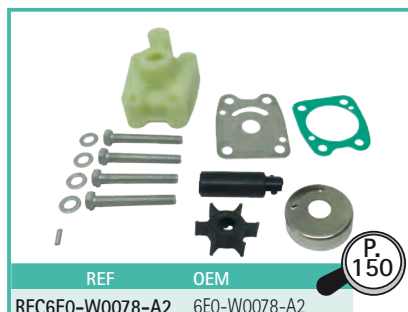



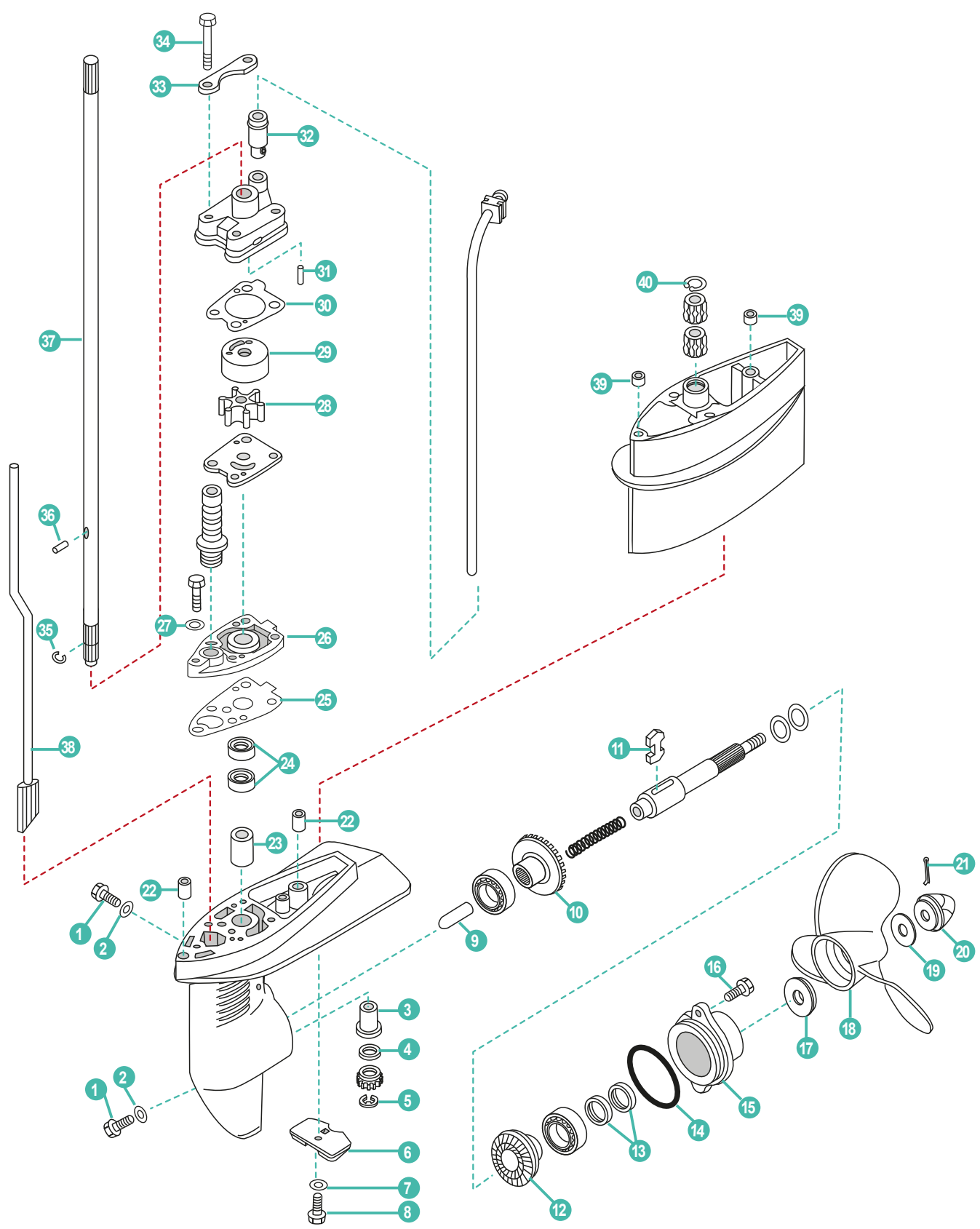

	REF	OEM				
1	REC90340-08002	90340-08002	TORNILLO DRENAJE	BOLT, DISCHARGING OIL	VITE DRENAGGIO	BOUCHON DE VIDANGE
2	REC90430-08020	90430-08020	JUNTA	GASKET	GUANIZIONE	JOINT
3	PAF4-03000002	6E0-45317-09	COJINETE	BEARING	CUSCINETTO	PALIER
4	PAF4-03000006	90201-11M49	ARANDELA	WASHER	RONDELLA	RONDELLE
5	REC99001-06600	99001-06600	CIRCLIP	CIRCLIP	CIRCLIP	CIRCLIP
6	CM6L5-45251-02A	68D-G5251-00	ÁNODO	ANODE	ANODO	ANODE
7	PAGB/T861.1-87	92990-06300	ARANDELA	WASHER	RONDELLA	RONDELLE
8	PAGB/T5783-M6X14	95895-06012	TORNILLO	SCREW	VITE	VIS
9	PAF4-03000008	67D-45635-00	ÉMBOLO	PLUGER, SHIFT	BULLONE	AXE DE VERROUILLAGE DU CRABOT
10	PAF4-03010000	67D-45560-00	PIÑÓN MARCHA AVANTE	POSITIVE GEAR ASSY	PIGNONE MARCIA AVANTI	PIGNON DE MARCHÉ AVANT
11	PAF4-03030002	67D-45631-01	SELECTOR	CLUTCH BLOCK	SELETTORE	BLOQUEUR
12	PAF4-03040000	67D-45570-00	PIÑÓN MARCHA ATRÁS	REVERSE GEAR	PIGNONE MARCIA INDIETRO	PIGNON MARCHÉ ARRIÈRE
13	REC93101-13M12	93101-13M12	RETÉN DE ACEITE	OIL SEAL	PARAOLIO	JOINT SPI
14	REC93210-48214	93210-48214	TÓRICA	O-RING	O-RING	JOINT TORIQUE
15	PAF4-03050001	68D-G5361-00-4D	TAPA CÁRTER	COVER, LOWER CASING	COPERCHIO CARTER	DIABOLO
16	PAGB/T5783-M5X12	95895-06016	TORNILLO HEXAGONAL	HEXAGON BOLT M6x18	VITE	VIS
17	PAF4-03000025	68D-G5987-00	ESPACIADOR	SPACER	DISTANZIALE	ENTRETOISE
18	PAF4-03070000	6E0-45943-01	HÉLICE	PROPELLER	ELICHE	HELICE
18	PAF2.6-03010000	6E0-45949-00	HÉLICE	PROPELLER	ELICHE	HELICE
19	PAF4-03000026	90201-08M54	ARANDELA INOX.	WASHER, STAINLESS STEEL	RONDELLA INOX.	RONDELLE INOX
20	PAF4-03080000	6L5-45646-00	TUERCA	LOCK NUT	DADO	ÉCROU
21	PAGB/T91-1.6X12	91490-25030	PASADOR ALETAS	PIN, COTTER 2.5x30	PIN	PIN
22	PAF4-00000001	90387-06806	ESPACIADOR	SPACER	DISTANZIALE	ENTRETOISE
23	PAF4-03000003	6E0-45316-09	RODAMIENTO	BALL BEARING	CUSCINETTO	ROULEMENT À BILLE
24	PAF4-03000027	93101-10M14	RETÉN DE ACEITE	OIL SEAL	PARAOLIO	JOINT SPI
25	PAF4-03000011	68D-G5315-A0	JUNTA BASE	GASKET, WATER PUMP BASE	GUARNIZIONE BASE POMPA ACQUA	JOINT DE POMPE À EAU
26	PAF4-03000012	68D-G5321-00	PLACA	OUT PLATE	PIASTRA	PLAQUE
27	PAGB/T97.1-6	92995-06600	ARANDELA	WASHER	RONDELLA	RONDELLE
28	REC6E0-44352-00	6E0-44352-00	TURBINA BOMBA AGUA	IMPELLER, WATER PUMP	GIRANTE POMPA	TURBINE DEPOMPE À EAU
29	PAF6-03000002	6BX-44322-00	TAPA, BOMBA AGUA	COVER, INNER WATER PUMP	COPERCHIO, POMPE ACQUA	INSERT DE POMPE À EAU
30	PAF4-03000018	6BX-G4315-01	JUNTA TAPA BOMBA AGUA	GASKET, WATER PUMP COVER	GUARNIZIONE COPERCHIO	JOINT COUVERCLE
31	PAF4-03000013	93604-18080	PASADOR BOMBA AGUA	PIN, WATER PUMP	SPINOTTO POMPA ACQUA	PIN DE POMPE À EAU
32	PAF4-03000021	67D-44366-00	TUBO GOMA BOMBA AGUA	RUBBER TUBE, WATER PUMP	TUBO IN GOMMA, POMPA	DURITE COUTCHOUÇ
33	PAF4-03000020	68D-G4328-00	PLCA BOMBA AGUA	PLATE, WATER PUMP FIXED	PIASTRA POMPA	PLAQUE ,POMPE À EAU
34	REC97095-06045	97095-06045	TORNILLO	SCREW	VITE	VIS
35	PAF4-03000005	90467-08M01	CLIP	CLIP	CLIP	CLIP
36	PAF4-03000016	93604-09066	PASADOR	PIN	SPINOTTO	CLAVETTE
37	PAF4-03000004S	68D-G5511-00	EJE VERTICAL S	DRIVE SHAFT S	ASSE VERTICALE S	ARBRE DE COMMANDE S
37	PAF4-03000004L	68D-G5511-10	EJE VERTICAL L	DRIVE SHAFT L	ASSE VERTICALE L	ARBRE DE COMMANDE L
38	PAF4-03020000S	6BX-G4150-00	EJE LEVA COMPLETO S	CAM ASSY, SHIFT ROD S	ASSE LEVA COMPLETO S	LEVIER DE VITESSE S
38	PAF4-03020000L	6BX-G4150-10	EJE LEVA COMPLETO L	CAM ASSY, SHIFT ROD L	ASSE LEVA COMPLETO L	LEVIER DE VITESSE L
39	PAF4-00000001	90387-06806	ESPACIADOR	SPACER	DISTANZIALE	ENTRETOISE
40	PAGB/T893.1-22	93420-22M03	SEGURO	CLAMP	BLOCCAGGIO	CLAVETTE



REC80W90U3  
REC80W90U6  
RECGREU1  
RECGREU12

P. 43

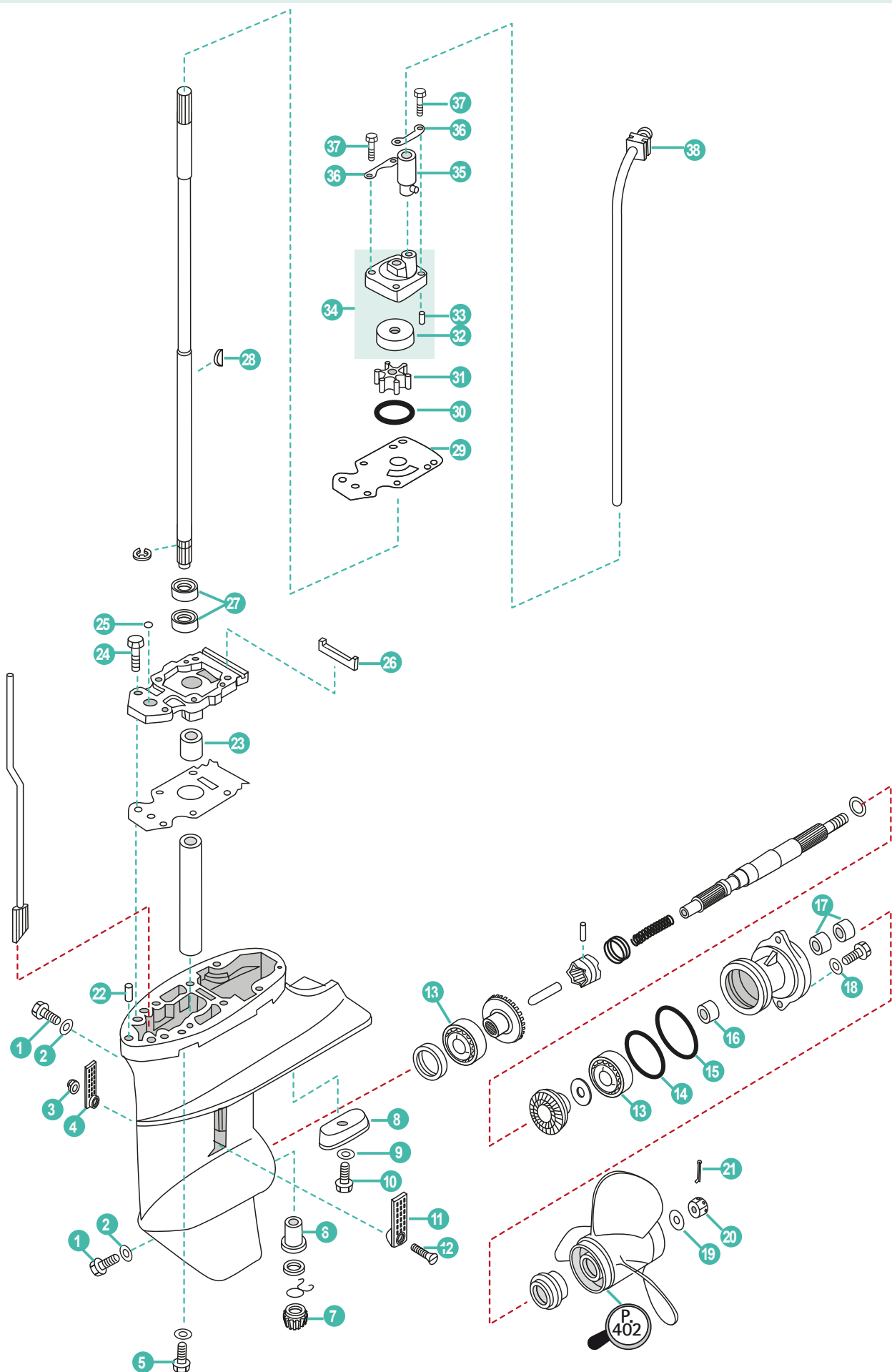

	REF	OEM				
1	REC90340-08002	90340-08002	TORNILLO DRENAJE	BOLT, DISCHARGING OIL	VITE DRENAGGIO	BOUCHON DE VIDANGE
2	REC90430-08020	90430-08020	JUNTA	GASKET	GUANIZIONE	JOINT
3	PAGB/T6182-M5	90185-05002	TUERCA AUTOBLOCANTE	NUT LOCKING M5	DADO CHIUSURA M5	ECROU FREIN M5
4	PAF15-06000002	6G1-45215-00	CUBIERTA ENTRADA DE AGUA 2	WATER INLET 2	COPERCHIO ENTRATA ACQUA 2	GRILLE D'ENTREE D'EAU 2
5	PAGB/T5783-M8X35	97075-08035	PERNO	STUD	BULLONE	BOULON
6	REC6G1-45317-09	6G1-45317-09	RODAMIENTO	BALL BEARING	CUSCINETTO	ROULEMENT À BILLE
7	REC68T-45551-00	6N0-G5551-A0	PIÑÓN ATAQUE	INITIATIVE GEAR	MARCIA INIZIATIVA	PIGNON D'ATTAQUE
8	CM68T-45251-00A	68T-45251-00	ÁNODO	ANODE	ANODO	ANODE
9	PAGB/T861.1-87	92990-06300	ARANDELA	WASHER	RONDELLA	RONDELLE
10	PAGB/T5783-M5X12	95895-06016	TORNILLO	SCREW	VITE	VIS
11	PAF15-06000003	6G1-45214-00	CUBIERTA ENTRADA DE AGUA 1	WATER INLET 1	COPERCHIO ENTRATA ACQUA 1	GRILLE D'ENTREE D'EAU 1
12	PAGB/T820-M5X25	90152-05M03	TORNILLO	SCREW	VITE	VIS
13	PAGB/T276-6004C2	93306-004YH	COJINETE	BEARING	CUSCINETTO	PALIER
14	REC93210-49046	93210-49046	TÓRICA	O-RING	O-RING	JOINT TORIQUE
15	REC93210-53M08	93210-53M08	TÓRICA	O-RING	O-RING	JOINT TORIQUE
16	REC6G1-45362-09	6G1-45362-09	RODAMIENTO	BALL BEARING	CUSCINETTO	ROULEMENT À BILLE
17	REC93101-15074	93101-15074	RETÉN DE ACEITE	OIL SEAL	PARAOLIO	JOINT SPI
18	PAGB/T97.1-6	92995-06600	ARANDELA	WASHER	RONDELLA	RONDELLE
19	REC90201-10M01	90201-10M01	ARANDELA	WASHER	RONDELLA	RONDELLE
20	REC90171-10M01	90171-10M01	TUERCA	LOCK NUT	DADO	ÉCROU
21	REC91490-30025	91490-30020	PASADOR ALETAS	PIN, COTTER	PIN	GOUILLE
22	PAF15-00000013	93604-12M07	PIN CENTRADOR	HOLLOW PIN	SPINOTTO DI CENTRAGGIO	PIN DE CENTRAGE
23	REC6G1-45316-09	6G1-45316-09	RODAMIENTO	BALL BEARING	CUSCINETTO	ROULEMENT À BILLE
24	PAGB/T5783-M8X25	97080-08025	PERNO	STUD	BULLONE	BOULON
25	REC93210-06ME6	93210-06ME6	TÓRICA	O-RING	O-RING	JOINT TORIQUE
26	PAF15-06020005	63V-45375-00	RETÉN DE GOMA	SEAL, RUBBER	TENUTA IN GOMMA	JOINT DE COUTCHOU
27	REC93101-11M23	93101-11M23	RETÉN DE ACEITE	OIL SEAL	PARAOLIO	JOINT SPI
28	REC664-44338-00	664-44338-00	CUÑA	KEY WOODRUFF	CHIAVETTA	CLAVETTE
29	REC68T-44323-00	68T-44323-00	JUNTA TAPA BOMBA AGUA	GASKET, WATER PUMP COVER	GUARNIZIONE COPERCHIO	JOINT COUVERCLE
30	REC93210-44398	93210-44398	TÓRICA	O-RING	O-RING	JOINT TORIQUE
31	REC68T-44352-00	68T-44352-00	TURBINA BOMBA AGUA	IMPELLER, WATER PUMP	GIRANTE POMPA	TURBINE DE POMPE À EAU
32	REC63V-44322-00	63V-44322-00	TAPA, BOMBA AGUA	COVER, INNER WATER PUMP	COPERCHIO, POMPE ACQUA	COUVERCLE, POMPE À EAU
33	PAF15-00000013	93604-12M07	PIN CENTRADOR	HOLLOW PIN	SPINOTTO DI CENTRAGGIO	PIN DE CENTRAGE
34	REC63V-44301-00	63V-44301-00	CUERPO BOMBA AGUA	HOUSING, WATER PUMP	CORPO POMPA	CORPS DE POMPE À EAU
35	REC68T-44366-00	68T-44366-00	TUBO GOMA BOMBA AGUA	RUBBER TUBE, WATER PUMP	TUBO IN GOMMA, POMPA	DURITE COUTCHOU
36	PAF15-06000014	63V-44328-00	PLACA	OUT PLATE	PIASTRA	PLAQUE
37	REC97080-08045	97080-08045	PERNO	STUD	BULLONE	BOULON
38	PAF15-02000006	63V-44365-10	GOMA DEL TUBO DE AGUA	I-SHAPED RUBBER BAND	GOMMA TUBO ACQUA	PLOT CAOUTCHOUC DE TUBE D'EAU



REC80W90U3  
REC80W90U6  
RECGREU1  
RECGREU12



REF OEM  
REC68T-W0001-20 68T-W0001-20



REF OEM  
REC68T-W0078-00 68T-W0078-00

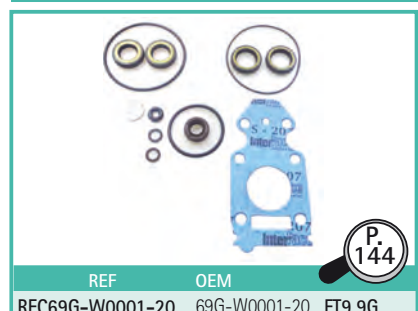

REF OEM  
REC69G-W0001-20 69G-W0001-20 FT9.9G



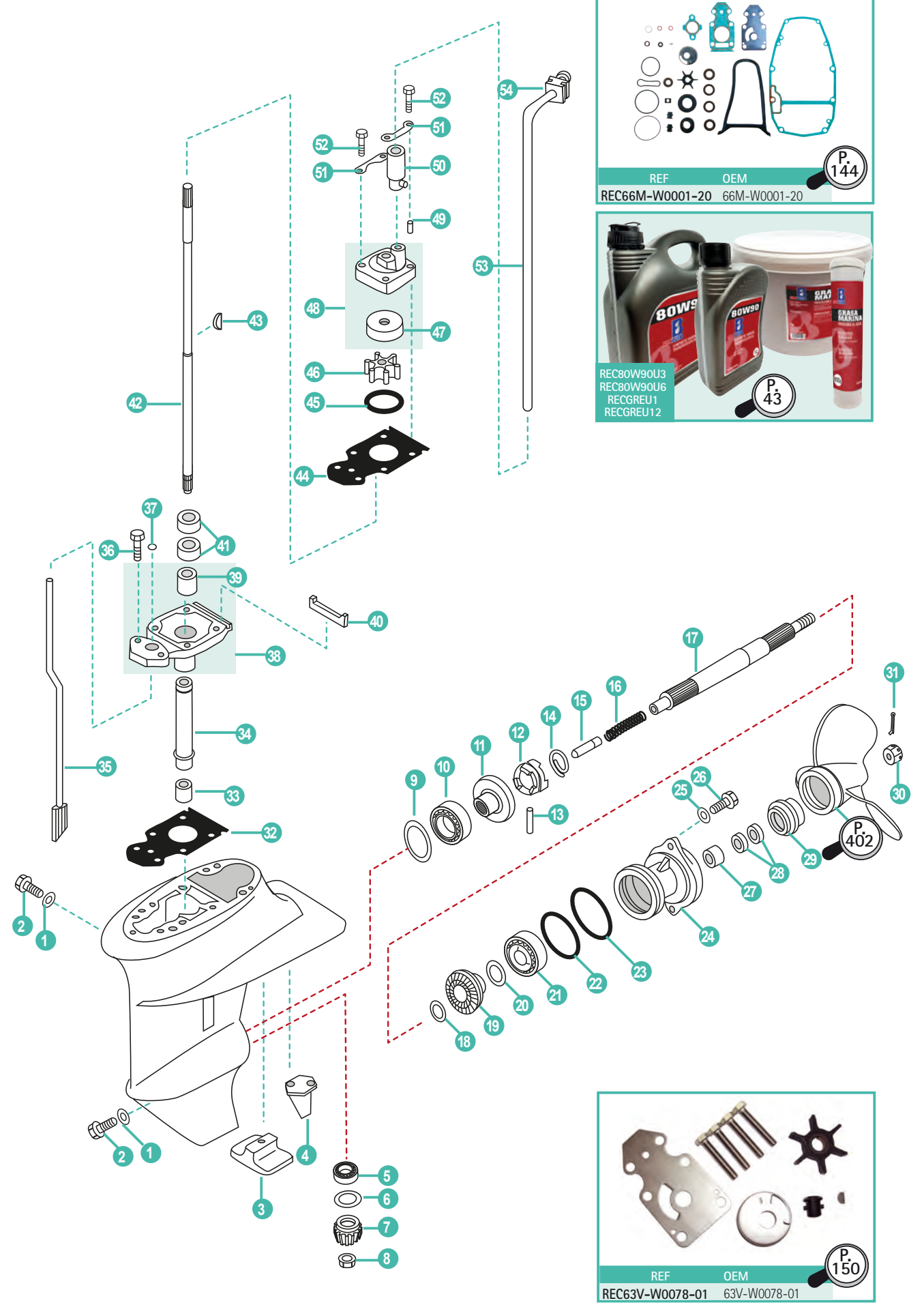

REF	OEM
REC66M-W0001-20	66M-W0001-20

P. 144

REC80W90U3  
REC80W90U6  
RECGRU1  
RECGRU12

P. 43

REF	OEM
REC63V-W0078-01	63V-W0078-01

P. 150

	REF	OEM				
	PAF15-06100000L	66M-45300-11-4D	COLA COMPLETA L	COMPLETE GEAR HOUSING L	PIEDE COMPLETO L	EMBASE COMPLETE L
	PAF15-06100000S	66M-45300-02-4D	COLA COMPLETA S	COMPLETE GEAR HOUSING S	PIEDE COMPLETO S	EMBASE COMPLETE S
1	REC90430-08020	90430-08020	ARANDELA	WASHER	RONDELLA	RONDELLE
2	REC90340-08002	90340-08002	TAPÓN ACEITE	PLUG, OIL	TAPPO OLIO	BOUCHON REMPLISSAGE D'HUILE
3	CM61N-45251-01	61N-45251-01	ÁNODO	ANODE	ANODO	ANODE
4	CM66M-45371-00	66M-45371-00	ÁNODO TIMÓN	TAB-TRIM	ANODO TIMONE	ANODE
5	REC93341-214U1	93314-314V8	COJINETE	BEARING	CUSCINETTO	PALIER
6	PAF15-06000008	6E8-45587-10-13	GRUESO	SHIM	SPESSORE	CALE
7	REC63V-45551-00	63V-45551-00	PIÑÓN ATAQUE	INITIATIVE GEAR	MARCIA INIZIATIVA	PIGNON D'ATTAQUE
8	REC90179-08M06	90179-08M06	TUERCA	LOCK NUT	DADO	ÉCROU
9	PAF15-06000010-1	664-45567-01-10	GRUESO	SHIM	SPESSORE	CALE
10	REC93332-00005	93332-00005	COJINETE	BEARING	CUSCINETTO	PALIER
11	REC6E7-45560-01	6E7-45560-01	PIÑÓN MARCHA AVANTE	POSITIVE GEAR ASSY	PIGNONE MARCIA AVANTI	PIGNON DE MARCHÉ AVANT
12	REC682-45631-00	682-45631-00	SELECTOR	CLUTCH BLOCK	SELETTORE	SELECTEUR
13	REC90250-05010	90250-05010	PASADOR	PIN	SPINOTTO	LEVIER
14	REC648-45633-00	648-45633-00	MUELLE	SPRING	MOLLA	RESSORT
15	REC650-45635-00	650-45635-00	ÉMBOLO	PLUNGER	BULLONE	BOUCHON
16	PAF15-06070002	90501-14M06	MUELLE	SPRING	MOLLA	RESSORT
17	REC683-45611-00	683-45611-00	EJE HÉLICE	PROPELLER SHAFT	ASSE ELICA	ARBRE D'HELICE
18	REC90201-17682	90201-17682	ARANDELA	WASHER	RONDELLA	RONDELLE
19	REC6E7-45570-00	6E7-45571-00	PIÑÓN MARCHA ATRÁS	REVERSE GEAR	PIGNONE MARCIA INDIETRO	PIGNON MARCHÉ ARRIÈRE
20	PAF15-06080006-1	626-45577-00-01	GRUESO	SHIM	SPESSORE	CALE
21	REC93306-00501	93306-00501	COJINETE	BEARING	CUSCINETTO	PALIER
22	REC93210-57M09	93210-57M09	TÓRICA	O-RING	O-RING	JOINT TORIQUE
23	PAF15-06080003	93210-56M80	TÓRICA	O-RING	O-RING	JOINT TORIQUE
24	REC683-45361-01-4D	683-45361-02-4D	DIÁBOLO	CAP, LOWER CASING	COPERCHIO CARTER INFERIORE	DIABOLO
25	PAGB/T97.1-1-6	92995-06600	ARANDELA	WASHER	RONDELLA	RONDELLE
26	PAGB/T5783-M6X20	97095-06020	TORNILLO	SCREW	VITE	VIS
27	REC93315-317U2	93315-317U2	COJINETE	BEARING	CUSCINETTO	PALIER
28	REC93101-17054	93101-17054	RETÉN DE ACEITE	OIL SEAL	PARAOLIO	JOINT SPI
29	REC6E7-45987-00	6E7-45987-00	ESPACIADOR	SPACER	DISTANZIALE	ENTRETOISE
30	REC90171-10M01	90171-10M01	TUERCA	LOCK NUT	DADO	ÉCROU
31	REC91490-30025	91490-30020	PASADOR ALETAS	PIN, COTTER	PIN	GOUPILLE
32	REC63V-45315-A0	63V-45315-A0	JUNTA	GASKET	GUANIZIONE	JOINT
33	REC93315-314V8	93315-314V8	COJINETE	BEARING	CUSCINETTO	PALIER
34	PAF15-06000006	63V-45536-00	CAMISA EJE	SLEEVE, DRIVE	TUBO GUIDA	TUBE GUIDE
35	PAF15-06030000S	63V-44150-00	VARILLA SELECTOR S	CAM ASSY, SHIFT ROD S	ASTICELLA CAMBIO S	LEVIER DE VITESSE S
	PAF15-06030000L	63V-44150-10	VARILLA SELECTOR L	CAM ASSY, SHIFT ROD L	ASTICELLA CAMBIO L	LEVIER DE VITESSE L
36	PAGB/T5783-M8X25	97080-08025	TORNILLO	SCREW	VITE	VIS
37	REC93210-06ME6	93210-06ME6	TÓRICA	O-RING	O-RING	JOINT TORIQUE
38	REC63V-45331-00-5B	63V-45331-00-5B	CUERPO DEL COJINETE	SHELL, BEARING	CORPO DE CUSCINETTO	LOGEMENT DE PALIER
39	REC626-45316-09	626-45316-09	CASQUILLO EJE	BUSHER, SHAFT	GOMMINO ASSE	DOUILLE
40	PAF15-06020005	63V-45375-00	RETÉN DE GOMA	SEAL, RUBBER	TENUTA IN COMMA	JOINT DE COUTCHOU
41	REC93101-20048	93101-20048	RETÉN DE ACEITE	OIL SEAL	PARAOLIO	JOINT SPI
42	PAF15-06040000S	63V-45510-00	EJE VERTICAL S	DRIVE SHAFT S	ASSE VERTICALE S	ARBRE DE COMMANDE S
	REC63V-45501-10	63V-45510-11	EJE VERTICAL L	DRIVE SHAFT L	ASSE VERTICALE L	ARBRE DE COMMANDE L
43	REC664-44338-00	664-44338-00	CUÑA	KEY WOODRUFF	CHIAVETTA	CLAVETTE
44	REC63V-44323-00	63V-44323-00	JUNTA TAPA BOMBA AGUA	GASKET, WATER PUMP COVER	GUARNIZIONE COPERCHIO	JOINT COUVERCLE
45	REC93210-44398	93210-44398	TÓRICA	O-RING	O-RING	JOINT TORIQUE
46	REC63V-44352-01	63V-44352-01	TURBINA	IMPELLER	GIRANTE	TURBINE
47	REC63V-44322-00	63V-44322-00	TAPA, BOMBA AGUA	COVER, INNER WATER PUMP	COPERCHIO, POMPE DACQUA	INSERT DE POMPE À EAU
48	REC63V-44301-00	63V-44301-00	CUERPO DE BOMBA	PUMP HOUSING	CORPO POMPA	CORPS DE POMPE À EAU
49	PAF15-00000013	93604-12M07	PASADOR	PIN	SPINOTTO	PIN
50	REC647-44366-00	647-44366-00	TUBO GOMA BOMBA AGUA	RUBBER TUBE, WATER PUMP	TUBO IN GOMMA, POMPA	DURITE COUTCHOU
51	PAF15-06000014	63V-44328-00	PLACA	OUT PLATE	PIASTRA	PLAQUE
52	REC97080-08045	97080-08045	PERNO	STUD	BULLONE	BOULON
53	PAF15-02000005S	66M-44361-00	TUBO DE AGUA S	WATER TUBE S	TUBO DELL'ACQUA S	DURITE D'EAU S
	PAF15-02000005L	66M-44361-10	TUBO DE AGUA L	WATER TUBE L	TUBO DELL'ACQUA L	DURITE D'EAU L
54	PAF15-02000006	63V-44365-10	GOMA DEL TUBO DE AGUA	I-SHAPED RUBBER BAND	GOMMA TUBO ACQUA	PLOT CAOUTCHOU DE TUBE D'EAU

4T F9.9H • F13.5B • F15C/M/E • F20B/E/M  
STROKES

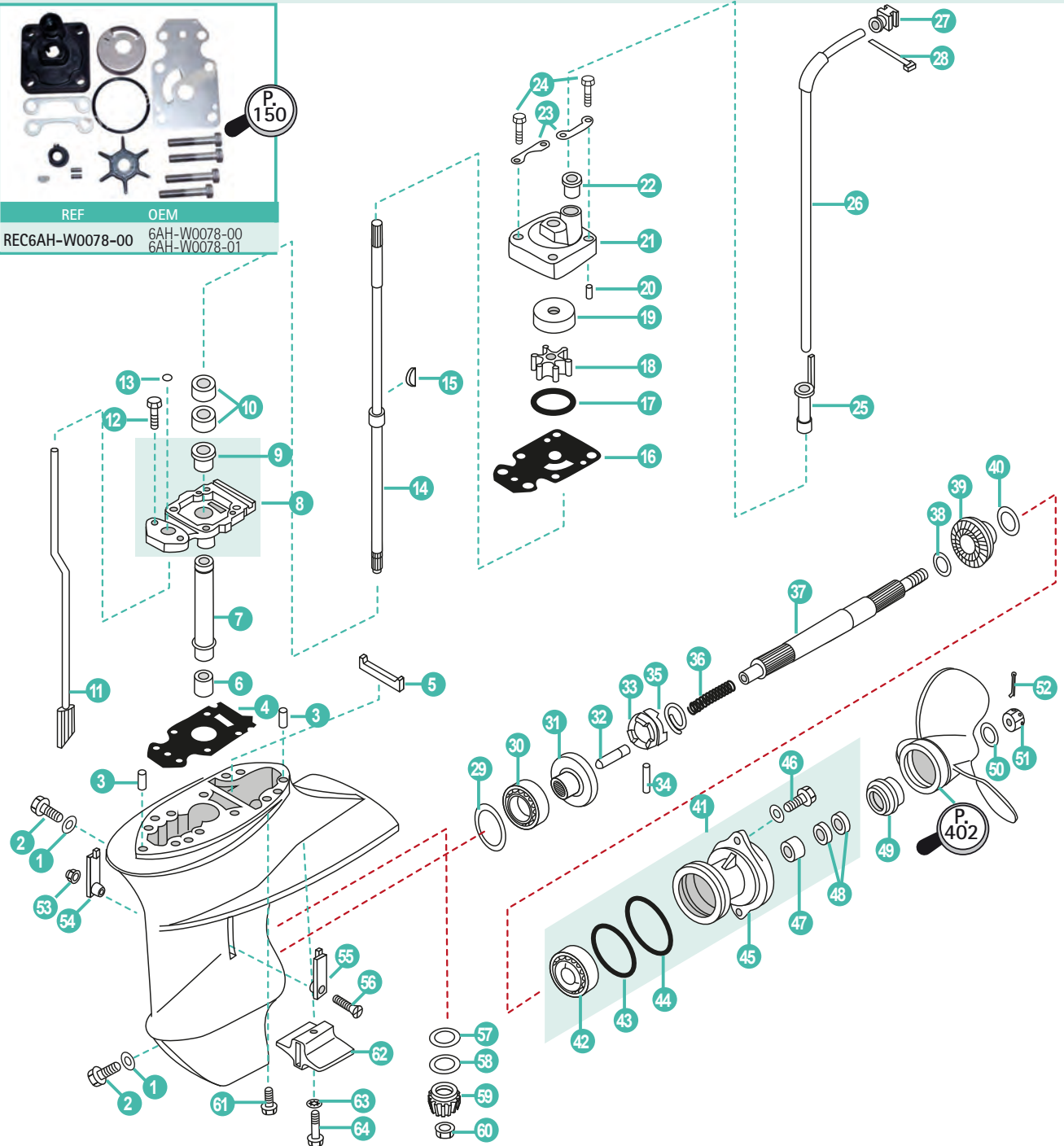

REF	OEM
REC6AH-W0078-00	6AH-W0078-00 6AH-W0078-01

REF	OEM				
PAF20-04000000L	6AH-45300-10-8D	COLA COMPLETA L	COMPLETE GEAR HOUSING L	PIEDE COMPLETO L	EMBASE COMPLETE L
PAF20-04000000S	6AH-45300-00-8D	COLA COMPLETA S	COMPLETE GEAR HOUSING S	PIEDE COMPLETO S	EMBASE COMPLETE S
1 REC90430-08020	90430-08003	ARANDELA	WASHER	RONDELLA	RONDELLE
2 REC90340-08002	90340-08002	TAPÓN ACEITE	PLUG, OIL	TAPPO OLIO	BOUCHON REMPLISSAGE D'HUILE
3 PAF15-00000013	93604-12M07	PIN CENTRADOR	HOLLOW PIN	SPINOTTO DI CENTRAGGIO	PIN DE CENTRAGE
4 PAF20-04000001	69G-45315-A0	JUNTA	GASKET	GUANIZIONE	JOINT
5 PAF15-06020005	63V-45375-00	RETÉN DE GOMA	SEAL, RUBBER	TENUTA IN COMMA	JOINT CAOUTCHOUC
6 REC93315-314V8	93315-314V8	RODAMIENTO	BALL BEARING	CUSCINETTO	ROULEMENT À BILLE
7 PAF15-06000006	63V-45536-00	CAMISA EJE	SLEEVE, DRIVE	TUBO GUIDA	TUBE GUIDE
8 PAF20-04010001	69G-45331-01-CA	CUERPO DEL COJINETE	SHELL, BEARING	CORPO DE CUSCINETTO	LOGEMENT DE PALIER
9 REC626-45316-09	626-45316-09	CASQUILLO EJE	BUSHER, SHAFT	GOMMINO ASSE	DOUILLE
10 REC93101-20048	93101-20001	RETÉN DE ACEITE	OIL SEAL	PARAOILIO	JOINT D'HUILE
11 PAF20-04020000S	6AH-44150-00	VARILLA SELECTOR S	CAM ASSY, SHIFT ROD S	ASTICELLA CAMBIO S	LEVIER DE VITESSE S
PAF20-04020000L	6AH-44150-10	VARILLA SELECTOR L	CAM ASSY, SHIFT ROD L	ASTICELLA CAMBIO L	LEVIER DE VITESSE L
12 REC93210-06ME6	93210-06ME6	TÓRICA	O-RING	O-RING	JOINT TORIQUE
13 PAGB/T5783-M8X25	97080-08025	TORNILLO	SCREW	VITE	VIS

	REF	OEM				
14	PAF20-04030000L PAF20-04030000S	6AH-45510-10 6AH-45510-00	EJE VERTICAL L EJE VERTICAL S	DRIVE SHAFT L DRIVE SHAFT S	ASSE VERTICALE L ASSE VERTICALE S	ARBRE DE COMMANDE L ARBRE DE COMMANDE S
15	REC664-44338-00	664-44338-00	CUÑA	KEY WOODRUFF	CHIAVETTA	CLAVETTE
16	REC68T-44323-00	68T-44323-00	JUNTA TAPA BOMBA AGUA	GASKET, WATER PUMP COVER	GUARNIZIONE COPERCHIO	JOINT COUVERCLE
17	REC93210-49046	93210-49046	TÓRICA	O-RING	O-RING	JOINT TORIQUE
18	REC63V-44352-01	63V-44352-01	TURBINA BOMBA AGUA	IMPELLER, WATER PUMP	GIRANTE POMPA	TURBINE DE POMPE À EAU
19	REC63V-44322-00	63V-44322-00	TAPA, BOMBA AGUA	COVER, INNER WATER PUMP	COPERCHIO, POMPE ACQUA	COUVERCLE DE POMPE À EAU
20	PAF15-00000013	93604-12M07	PASADOR BOMBA AGUA	PIN, WATER PUMP	SPINOTTO POMPA ACQUA	LEVIER POMPE D'EAU
21	PAF20-04040001	6AH-44311-00	CUERPO BOMBA AGUA	HOUSING, WATER PUMP	CORPO POMPA	CORPS DE POMPE À EAU
22	PAF25-04050004	6L2-44367-00	TUBO GOMA BOMBA AGUA	RUBBER TUBE, WATER PUMP	TUBO IN GOMMA, POMPA	DURITE DE COUTCHOU
23	PAF15-06000014	63V-44328-01	PLACA	OUT PLATE	PIASTRA	PLAQUE
24	REC97095-08045	97095-08045	PERNO	STUD	BULLONE	BOULON
25	PAF20-02000005	6AH-44368-00	TUBO DE AGUA	WATER TUBE	TUBO DELL'ACQUA	DURITE D'EAU
26	PAF20-02000101L PAF20-02000101S	6AH-44361-11 6AH-44361-01	TUBO DE AGUA L TUBO DE AGUA S	WATER TUBE L WATER TUBE S	TUBO DELL'ACQUA L TUBO DELL'ACQUA S	DURITE D'EAU L DURITE D'EAU S
27	PAF20-02000007	6AH-44365-00	GOMA DEL TUBO DE AGUA	I-SHAPED RUBBER BAND	GOMMA TUBO ACQUA	PLOT CAOUTCHOU DE TUBE D'EAU
28	PAHT-2.5X50	90465-11M10	BRIDA 2,5X50	CLAMP	FASCETTA	COLLIER RILSAN 2,5X50
29	PAF15-06000010-1	664-45567-01	GRUESO 0.10 mm	SHIM 0.10 mm	SPESSORE 0.10 mm	CALE 0.10 mm
	PAF15-06000010-2	664-45567-10	GRUESO 0.12 mm	SHIM 0.12 mm	SPESSORE 0.12 mm	CALE 0.12 mm
	PAF15-06000010-3	664-45567-20	GRUESO 0.15 mm	SHIM 0.15 mm	SPESSORE 0.15 mm	CALE 0.15 mm
	PAF15-06000010-4	664-45567-30	GRUESO 0.18 mm	SHIM 0.18 mm	SPESSORE 0.18 mm	CALE 0.18 mm
	PAF15-06000010-5	664-45567-40	GRUESO 0.30 mm	SHIM 0.30 mm	SPESSORE 0.30 mm	CALE 0.30 mm
	PAF15-06000010-6	664-45567-50	GRUESO 0.40 mm	SHIM 0.40 mm	SPESSORE 0.40 mm	CALE 0.40 mm
	PAF15-06000010-7	664-45567-60	GRUESO 0.50 mm	SHIM 0.50 mm	SPESSORE 0.50 mm	CALE 0.50 mm
30	REC93332-00005	93332-00005	RODAMIENTO	BALL BEARING	CUSCINETTO	ROULEMENT À BILLE
31	REC6E7-45560-01	6E7-45560-01	PIÑÓN MARCHA AVANTE	POSITIVE GEAR ASSY	PIGNONE MARCIA AVANTI	PIGNON DE MARCHÉ AVANT
32	REC650-45635-00	650-45635-00	ÉMBOLO	PLUNGER	BULLONE	BOUCHON
33	REC682-45631-00	682-45631-00	SELECTOR	CLUTCH BLOCK	SELETTORE	SELECTEUR
34	REC90250-05010	90250-05010	PASADOR	PIN	SPINOTTO	LEVIER
35	REC648-45633-00	648-45633-11	MUELLE	SPRING	MOLLA	RESSORT
36	PAF15-06070002	90501-150A0	MUELLE	SPRING	MOLLA	RESSORT
37	REC683-45611-00	683-45611-00	EJE HÉLICE	PROPELLER SHAFT	ASSE ELICA	ARBRE D'HELICE
38	REC90201-17682	90201-17682	ARANDELA	WASHER	RONDELLA	RONDELLE
39	REC6E7-45570-00	6E7-45570-00	PIÑÓN MARCHA ATRÁS	REVERSE GEAR	PIGNONE MARCIA INDIETRO	PIGNON MARCHE ARRIÈRE
40	PAF15-06080006-1	626-45577-00	GRUESO 0.10 mm	SHIM 0.10 mm	SPESSORE 0.10 mm	CALE 0.10 mm
	PAF15-06080006-2	626-45577-10	GRUESO 0.20 mm	SHIM 0.20 mm	SPESSORE 0.20 mm	CALE 0.20 mm
	PAF15-06080006-3	626-45577-20	GRUESO 0.30 mm	SHIM 0.30 mm	SPESSORE 0.30 mm	CALE 0.30 mm
	PAF15-06080006-4	626-45577-30	GRUESO 0.40 mm	SHIM 0.40 mm	SPESSORE 0.40 mm	CALE 0.40 mm
	PAF15-06080006-5	626-45577-40	GRUESO 0.50 mm	SHIM 0.50 mm	SPESSORE 0.50 mm	CALE 0.50 mm
41	PAF15-06080000	683-45361-02-8D	FUNDA INFERIOR COMPLETA	COVER ASSY, LOWER CASING	COVER INFERIORE COMPLETA	DIABOLO COMPLET
42	REC93306-00501	93306-00501	COJINETE	BEARING	CUSCINETTO	ROULEMENT
43	REC93210-57M09	93210-57M09	TÓRICA	O-RING	O-RING	JOINT TORIQUE
44	PAF15-06080003	93210-56M80	TÓRICA	O-RING	O-RING	JOINT TORIQUE
45	REC683-45361-01-4D	683-45361-02-8D	DIÁBOLO	CAP, LOWER CASING	COPERCHIO CARTER INFERIORE	DIABOLO
46	PAGB/T5783-M6X20	97575-06520	TORNILLO	SCREW	VITE	VIS
47	REC93315-317U2	93315-317U2	COJINETE	BEARING	CUSCINETTO	PALIER
48	REC93101-17054	93101-17054	RETÉN DE ACEITE	OIL SEAL	PARAOLIO	JOINT SPI
49	REC6E7-45987-00	6E7-45987-01	ESPACIADOR	SPACER	DISTANZIALE	ENTRETOISE
50	PAGB/T96-10	90201-10M01	ARANDELA	WASHER	RONDELLA	RONDELLE
51	REC90171-10M01	90171-10M01	TUERCA	LOCK NUT	DADO	ÉCROU
52	REC91490-30025	94190-30020	PASADOR ALETAS	PIN, COTTER	PIN	GOUPILLE
53	PAGB/T6182-M5	90185-05002	TUERCA	LOCK NUT	DADO	ÉCROU
54	PAF15-06000002	63V-45215-00	CUBIERTA, ENTRADA AGUA 2	WATER INLET A	COPERCHIO ENTRATA ACQUA A	GRILLE D'ENTREE D'EAU A
55	PAF15-06000003	6G1-45214-00	CUBIERTA, ENTRADA AGUA 1	WATER INLET B	COPERCHIO ENTRATA ACQUA B	GRILLE D'ENTREE D'EAU B
56	PAGB/T820-M5X20	90152-05011	TORNILLO	SCREW	VITE	VIS
57	PAF15-06000020-1	90201-15017	ARANDELA	WASHER	RONDELLA	RONDELLE
58	PAF15-06000008	6E8-45587-10	GRUESO 1.13 mm	SHIM 1.13 mm	SPESSORE 1.13 mm	CALE 1.13 mm
	PAF15-06000009	6E8-45587-30	GRUESO 1.20 mm	SHIM 1.20 mm	SPESSORE 1.20 mm	CALE 1.20 mm
59	REC63V-45551-00	63V-45551-00	PIÑÓN ATAQUE	INITIATIVE GEAR	MARCIA INIZIATIVA	PIGNON D'ATTAQUE
60	REC90179-08M06	90179-08M06	TUERCA	LOCK NUT	DADO	ÉCROU
61	PAGB/T5783-M8X30	97575-08530	PERNO	STUD	BULLONE	BOULON
62	TEN01154AL	6AH-45251-00	ÁNODO	ANODE	ANODO	ANODE
63	PAGB/T861.1-6	92990-06300	ARANDELA	WASHER	RONDELLA	RONDELLE
64	PAGB/T5783-M6X30	95895-06035	TORNILLO	SCREW	VITE	VIS



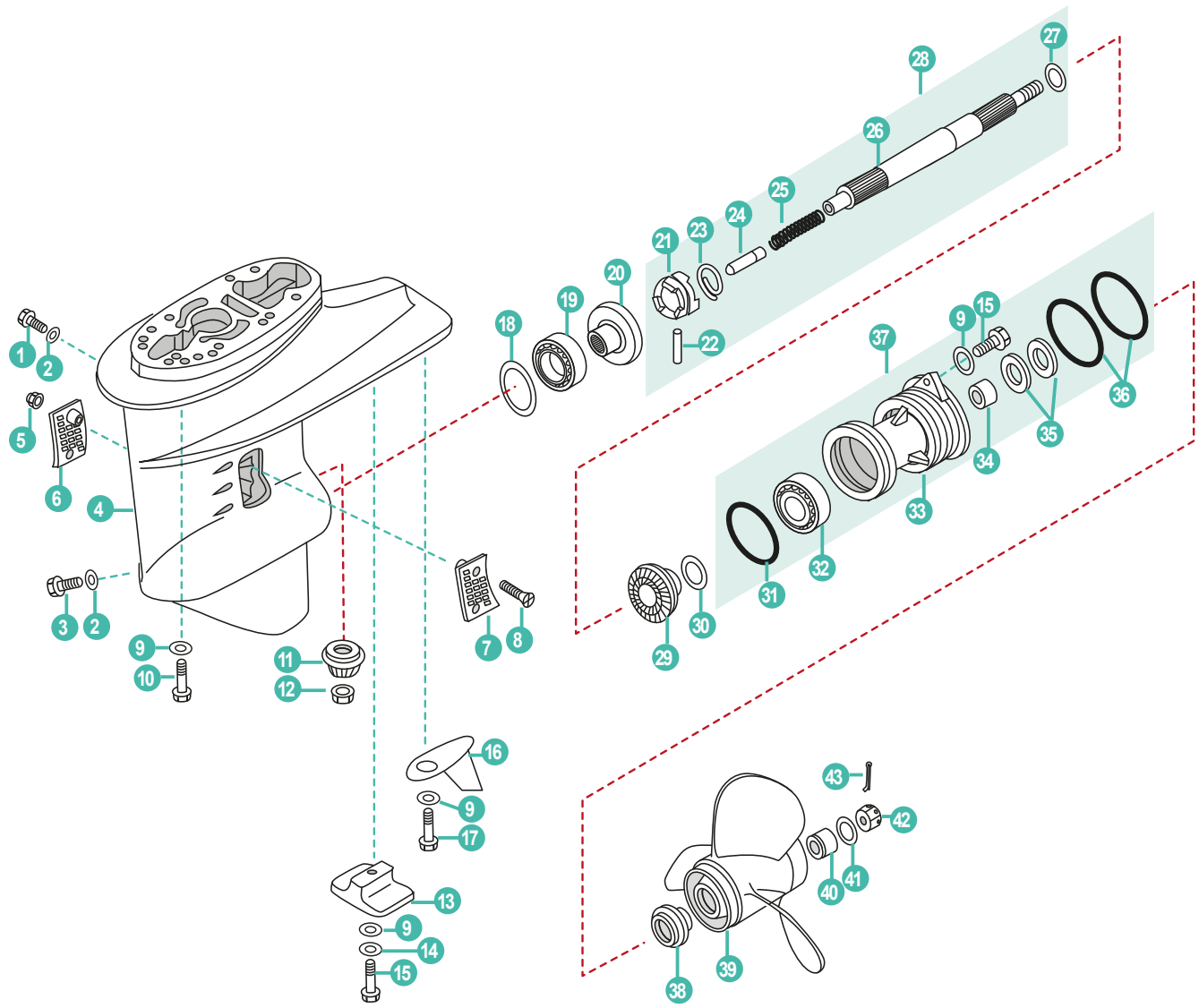

	REF	OEM				
	PAF25-04090000L	65W-45300-10-4D	COLA COMPLETA L	COMPLETE GEAR HOUSING L	PIEDE COMPLETO L	EMBASE COMPLETE L
	PAF25-04090000S	65W-45300-00-4D	COLA COMPLETA S	COMPLETE GEAR HOUSING S	PIEDE COMPLETO S	EMBASE COMPLETE S
1	REC90340-08002	90340-08M04	TAPÓN ACEITE	PLUG, OIL	TAPPO OLIO	BOUCHON REMPLISSAGE D'HUILE
2	REC90430-08020	93210-06ME6	JUNTA	GASKET	GUANIZIONE	JOINT
3	REC688-45341-00	688-45341-00	TAPÓN DE DESAGÜE	PLUG, DRAIN	TAPPO DRENAGGIO	BOUCHON DE VIDANGE
4	PAF25-04000001	61N-45311-02-4D	CARTER	LOWER CASING	CARTER	CARTER D'EMBASE
5	PAGB/T889.1-2000	90185-05002	TUERCA	NUT, LOCKING	DADO	ÉCROU
6	PAF25-04000023	6L2-45215-00	CUBIERTA ENTRADA AGUA B	WATER INLET B	COPERCHIO ACQUA B	GRILLE D'ENTREE D'EAU B
7	PAF25-04000022	6L2-45214-00	CUBIERTA ENTRADA AGUA A	WATER INLET A	COPERCHIO ACQUA A	GRILLE D'ENTREE D'EAU A
8	PAGB/T820-M5X30	90151-05M05	TORNILLO	SCREW, PAN HEAD	VITE	VIS
9	PAGB/T97.1-8	92995-10600	ARANDELA	WASHER	RONDELLA	RONDELLE
10	PAF25-00000011	90105-10M12	TORNILLO	BOLT	VITE	VIS
11	PAF25-04000005	61N-45551-00	PIÑÓN ATAQUE	INITIATIVE GEAR	MARCIA INIZIATIVA	PIGNON D'ATTAQUE
12	REC90179-10M14	90179-10M14	TUERCA	NUT, PINION	DADO	ÉCROU
13	PAF15-06000004	61N-45251-00	ÁNODO	ANODE, LOWER	ANODO	ANODE
14	PAGB/T861.1-87	92990-06300	ARANDELA	WASHER, LOCKING	RONDELLA	RONDELLE
15	PAGB/T5782-M6X125	95895-06035	TORNILLO	BOLT	VITE	VIS
16	PAF25-04000021	61N-45214-00	PLACA TIMÓN	TAB, COURSE	PIASTRA TIMONE	DERIVE
17	PAGB/T5783-M5X12	90119-06M48	TORNILLO	BOLT	VITE	VIS
18	PAF25-04000004-3	6L2-45567-12	GRUESO 1.2 mm	SHIM 1.2 mm	SPESSORE 1.2 mm	CALE 1.2 mm
	PAF25-04000004-5	6L2-45567-14	GRUESO 1.4mm	SHIM 1.4 mm	SPESSORE 1.4 mm	CALE 1.4 mm
19	REC93332-00005	93332-00005	RODAMIENTO	BALL BEARING	CUSCINETTO	ROULEMENT À BILLE
20	REC61N-45560-10	61N-45560-00	PIÑÓN MARCHA AVANTE	POSITIVE GEAR ASSY	PIGNONE MARCIA AVANTI	PIGNON DE MARCHÉ AVANT
21	PAF25-04060003	664-45631-02	SELECTOR	CLUTCH BLOCK	SELETTORE	CRABOT
22	REC90250-05010	90250-05010	PASADOR	PIN	SPINOTTO	LEVIER
23	REC648-45633-00	648-45633-00	MUELLE	SPRING	MOLLA	RESSORT
24	REC648-45635-00	648-45635-00	ÉMBOLO	PLUNGER	BULLONE	BOUCHON
25	PAF25-04060002	90501-10065	MUELLE	SPRING	MOLLA	RESSORT
26	REC6L2-45611-00	612-45611-00	EJE HÉLICE	PROPELLER SHAFT	ASSE ELICA	ARBRE D'HELICE
27	PAF25-04060007	90201-20417	GRUESO	SHIM	SPESSORE	CALE
28	PAF25-04060000	648-45633-11	EJE HÉLICE COMPELTO	PROPELLER, SHAFT ASSY	ASSE ELICHE COMPLETO	ARBRE D'HELICE COMPLÈTE
29	PAF25-04070004	61N-45571-00	PIÑÓN MARCHA INVERSA	GEAR, REVERSE	MARCIA INDIETRO	PIGNON MARCHÉ ARRIÈRE
30	PAF25-04070005-1	6L2-45577-00-10	GRUESO 1.0 mm	SHIM 1.0 mm	SPESSORE 1.0 mm	CALE 1.0 mm
	PAF25-04070005-3	6L2-45577-00-12	GRUESO 1.2 mm	SHIM 1.2 mm	SPESSORE 1.2 mm	CALE 1.2 mm
31	REC93210-64ME7	93210-64ME7	TÓRICA	O-RING	O-RING	JOINT TORIQUE
32	PAGB/T276-6006/P6	93306-00612	RODAMIENTO	BALL BEARING	CUSCINETTO	ROULEMENT À BILLE
33	PAF25-04070001	61N-45361-01-4D	DIÁBOLO	CAP, LOWER CASING	COPERCHIO CARTER INFERIORE	DIABOLO
34	REC93315-22004	93315-22004	RODAMIENTO	BALL BEARING	CUSCINETTO	ROULEMENT À BILLE
35	REC93101-20M07	93101-20M07	RETÉN DE ACEITE	OIL SEAL	PARAOLIO	JOINT SPI
36	REC93210-65M50	93210-65M50	TÓRICA	O-RING	O-RING	JOINT TORIQUE
37	PAF25-04070000	61N-45361-01-8D	TAPA CÁRTER COMPLETA	COVER ASSY, LOWER CASING	COPERCHIO CARTER COMPLETA	DIABOLO COMPLET
38	REC6L2-45987-00	6L2-45987-01	ESPACIADOR	SPACER, PROPELLER	SPESSORE	ENTRETOISE
39	PAF25-04080000	664-45947-01-EL	HÉLICE	PROPELLER ASSY	ELICHE	HELICE
40	REC689-45997-00	689-45997-00	ESPACIADOR	SPACER	SPESSORE	ENTRETOISE
41	PAGB/T97.1-8	92990-14200	ARANDELA	WASHER	RONDELLA	RONDELLE
42	REC90171-14013-00	90171-14013	TUERCA	NUT	DADO	ÉCROU
43	PAGB/T91-1.6X12	91490-30022	PIN	PIN, COTTER	SPINOTTO	GOUPILLE

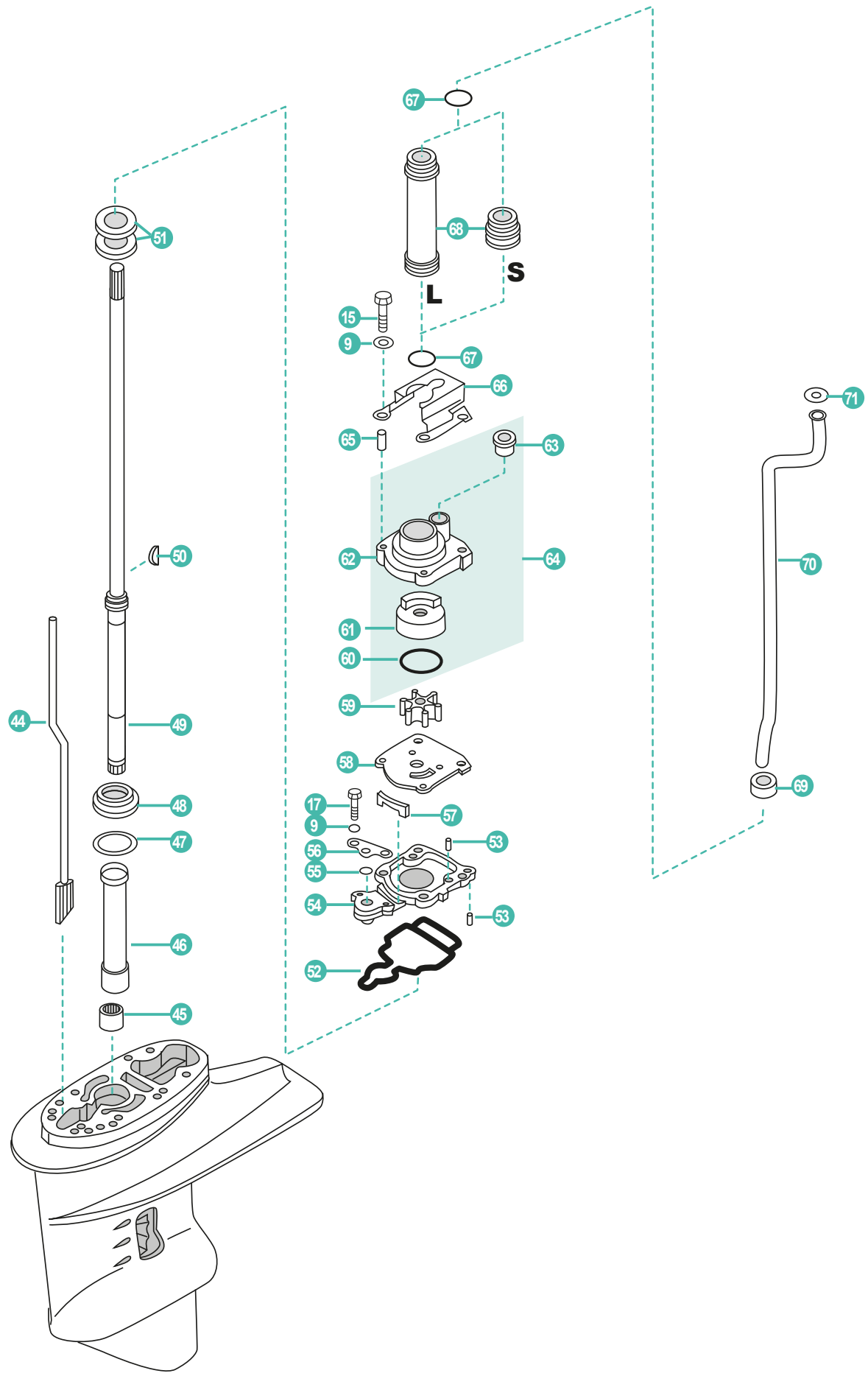

	REF	OEM				
44	PAF25-04030000L PAF25-04030000S	65W-44150-10 65W-44150-00	VARILLA SELECTOR L VARILLA SELECTOR S	CAM ASSY, SHIFT ROD L CAM ASSY, SHIFT ROD S	ASTICELLA CAMBIO L ASTICELLA CAMBIO S	LEVIER DE VITESSE L LEVIER DE VITESSE S
45	PAGB/T290F-2020	93315-220V7	RODAMIENTO	BALL BEARING	CUSCINETTO	ROULEMENT À BILLE
46	PAF25-04000002	61N-45536-00	CASQUILLO	BUSHING, NYLON	GHIERA	BAGUE NYLON
	PAF25-04000003-2	61N-45587-00-10	GRUESO 1.0 mm	SHIM 1.0 mm	SPESSORE 1.0 mm	CALE 1.0 mm
	PAF25-04000003-3	61N-45587-00-11	GRUESO 1.1 mm	SHIM 1.1 mm	SPESSORE 1.1 mm	CALE 1.1 mm
47	PAF25-04000003-4	61N-45587-00-12	GRUESO 1.2 mm	SHIM 1.2 mm	SPESSORE 1.2 mm	CALE 1.2 mm
	PAF25-04000003-5	61N-45587-00-13	GRUESO 1.3 mm	SHIM 1.3 mm	SPESSORE 1.3 mm	CALE 1.3 mm
	PAF25-04000003-6	61N-45587-00-14	GRUESO 1.4mm	SHIM 1.4 mm	SPESSORE 1.4 mm	CALE 1.4 mm
	PAF25-04000003-7	61N-45587-00-15	GRUESO 1.5mm	SHIM 1.5 mm	SPESSORE 1.5 mm	CALE 1.5 mm
48	PAHI-CAP32004JRK0YO	93332-000W5	CUERPO RODAMIENTO	HOUSING, BEARING	CORPO CUSCINETTO	LOGEMENT DE ROULEMENT
49	PAF25-04010000L PAF25-04010000S	61N-45510-10 61N-45510-00	EJE VERTICAL L EJE VERTICAL S	DRIVE SHAFT L DRIVE SHAFT S	ASSE VERTICALE L ASSE VERTICALE S	ARBRE DE COMMANDE L ARBRE DE COMMANDE S
50	PAF25-04000015	90280-03024	CHAVETA	KEY WOODRUFF	CHIAVETTA	CLAVETTE
51	REC93101-22M00	93101-22067	RETÉN DE ACEITE	OIL SEAL	PARAOILIO	JOINT D'HUILE
52	PAF25-04000009	61N-45315-00	RETÉN	SEAL	TENUTA	JOINT
53	PAF25-04000007	93604-10M03	PIN	PIN, COTTER	SPINOTTO	PLOT DE CENTRAGE F4X12
54	PAF25-04000008	65W-45331-00-5B	BASE EJE VERTICAL	BASE, DRIVE SHAFT	BASE, ASSE VERTICALE	BASE POUR ARBRE D'ENTRAÎNEMENT
55	REC93210-06ME6	93210-06ME6	TÓRICA	O-RING	O-RING	JOINT TORIQUE
56	PAF25-04000012	65W-44176-00	PLACA	OUT PLATE	PIASTRA	PLAQUE
57	PAF25-04000013	61N-45127-00	RETÉN AGUA	WATER SEAL	PARAOILIO ACQUA	RONDELLE JOINT
58	REC61N-44323-00	61N-44323-00	JUNTA TAPA BOMBA AGUA	GASKET, WATER PUMP COVER	GUARNIZIONE COPERCHIO	JOINT COUVERCLE
59	REC6H4-44352-02	6H4-44352-02	TURBINA BOMBA AGUA	IMPELLER, WATER PUMP	GIRANTE POMPA	TURBINE DE POMPE À EAU
60	PAF25-04050003	93210-45161	TÓRICA	O-RING	O-RING	JOINT TORIQUE
61	REC61N-44322-00	61N-44322-01	ACOPLE INOX	INSERT CARTRIDGE	ACCOPPIAMENTO INOX	INSERT DE POMPE À EAU
62	PAF25-04050001	61N-44311-01	CUERPO BOMBA	SHELL, WATER PUMP	CORPO POMPA	CORPS DE POMPE À EAU
63	PAF25-04050004	6L2-44367-00	RETÉN TUBO AGUA	DAMPER, WATER PIPE	AMMORTIZZATORE, TUBO DELL'ACQUA	MANCHON TUYAU D'EAU
64	PAF25-04050000	61N-44311-01	KIT CUERPO BOMBA	SHELL ASSY, WATER PUMP	KIT CORPO POMPA	KIT COPRS DE POMPE À EAU
65	REC93606-12019	93606-11M24	PIN	PIN, DOWEL	SPINOTTO	PLOT DE CENTRAGE
66	PAF25-04000016	65W-44328-00	PLATO FIJO BOMBA AGUA	FIXED PLATE, WATER PUMP	PIASTRA POMPA	PLAQUE FIXATION CORPS DE POMPE À EAU
67	PAGB/T3452.1-25.8X2	93210-26130	TÓRICA	O-RING	O-RING	JOINT TORIQUE
68	PAF25-04000017 PAF25-04000017S	61N-44362-10 61N-44362-00	TUBO DE AGUA L TUBO DE AGUA S	WATER TUBE L WATER TUBE S	TUBO DELL'ACQUA L TUBO DELL'ACQUA S	DURITE D'EAU L DURITE D'EAU S
69	PAF25-02000005	90430-12072	JUNTA AGUA	GASKET, WATER PIPE	GUARNIZIONE	JOINT
70	PAF25-02000004L PAF25-02000004S	65W-44361-10 65W-44361-00	TUBO DE AGUA L TUBO DE AGUA S	WATER TUBE L WATER TUBE S	TUBO DELL'ACQUA L TUBO DELL'ACQUA S	DURITE D'EAU L DURITE D'EAU S
71	PAF25-02000019	90202-12060	ARANDELA	WASHER, NYLON	RONDELLA	RONDELLE

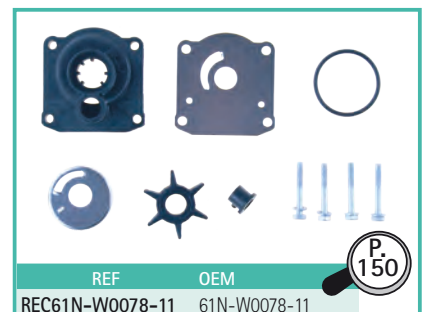



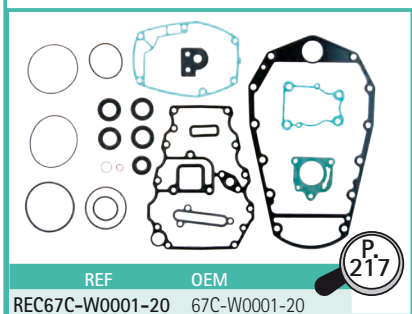
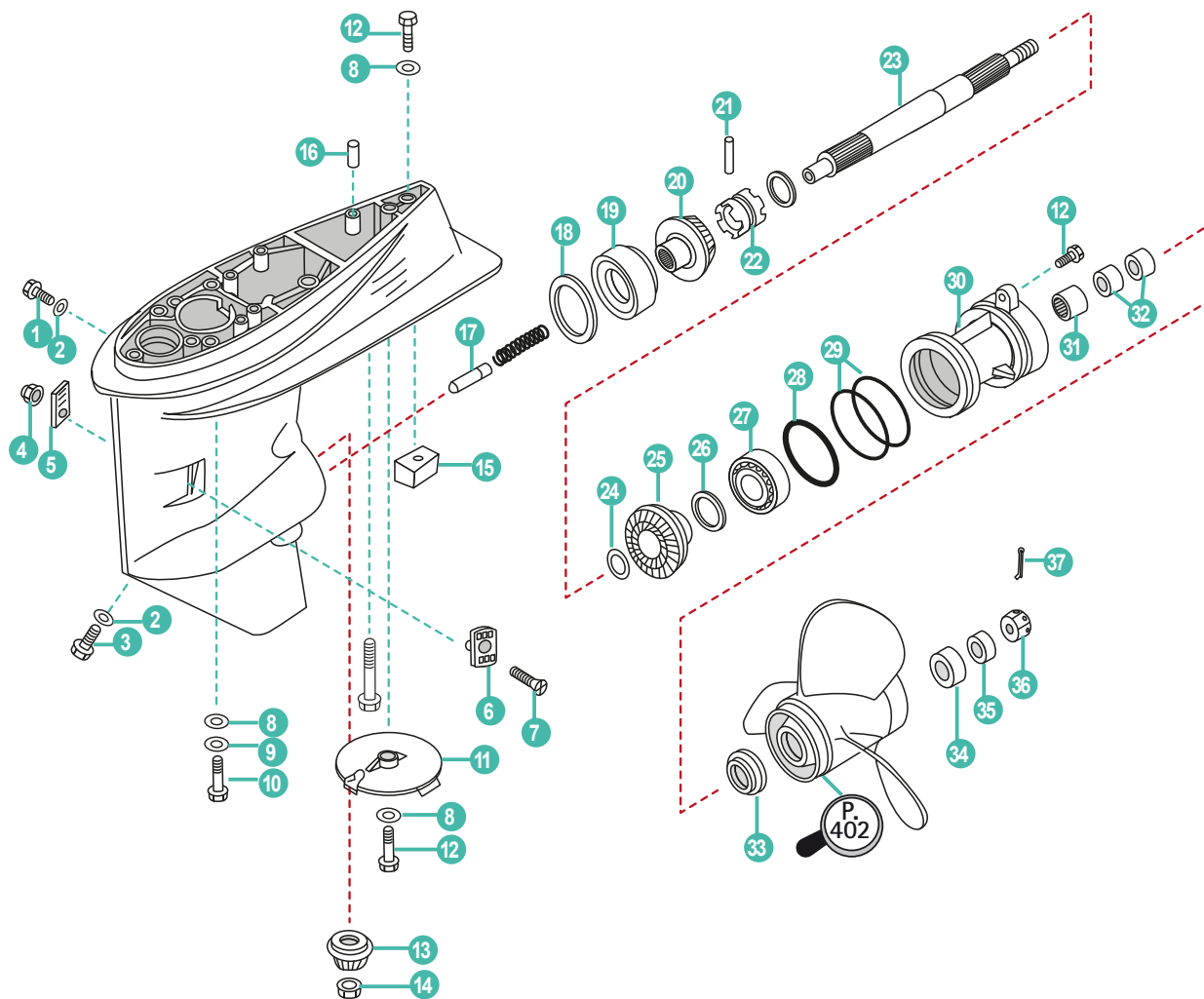

	REF	OEM				
1	REC90340-08002	90340-08002	TAPÓN ACEITE	PLUG, OIL	TAPPO OLIO	BOUCHON DE NIVEAU D'HUILE
2	REC90430-08020	90430-08020	JUNTA	GASKET	GUARNIZIONE	JOINT
3	REC688-45341-00	688-45341-10	TAPÓN ACEITE	PLUG, OIL	TAPPO OLIO	BOUCHON REMPLISSAGE D'HUILE
4	PAGB/T889.1-M5	95380-05600	TUERCA	LOCK NUT	DADO	ÉCROU
5	PAT40-04000023	63D-45215-00	CUBIERTA ENTRADA AGUA B	WATER INLET B	COPERCHIO ACQUA B	GRILLE D'ENTREE D'EAU B
6	PAT40-04000022	63D-45214-00	CUBIERTA ENTRADA AGUA A	WATER INLET A	COPERCHIO ACQUA A	GRILLE D'ENTREE D'EAU A
7	PAGB/T820-M5X30	90142-05M06	TORNILLO	SCREW	VITE	VIS
8	PAGB/T97.1-8	92995-10600	ARANDELA	WASHER	RONDELLA	RONDELLE
9	PAGB/T97.1-10	92995-10100	ARANDELA	WASHER	RONDELLA	RONDELLE
10	REC97075-10040	97075-10040	PERNO	STUD	BULLONE	BOULON
11	CM67C-45371-00A	67C-45371-00	ÁNODO	ANODE	ANODO	ANODE
12	PAGB/T5783-M8X25	97095-08025	PERNO	STUD	BULLONE	BOULON
13	REC66T-45551-00	66T-45551-00	PIÑÓN ATAQUE	INITIATIVE GEAR	MARCIA INIZIATIVA	PIGNON D'ATTAQUE
14	REC90170-12138	90170-12138	TUERCA	LOCK NUT	DADO	ÉCROU
15	CM67C-45251-00A	67C-45251-00	ÁNODO	ANODE	ANODO	ANODE
16	REC93606-12019	93606-12019	PASADOR	PIN	SPINOTTO	LEVIER
17	REC66T-45635-00	66T-45635-00	ÉMBOLO	PLUNGER	BULLONE	BOUCHON
	PAT40-04000004-1	663-45567-01	GRUESO 0.10 mm	SHIM 0.10 mm	SPESSORE 0.10 mm	CALE 0.10 mm
18	PAT40-04000004-2	663-45567-10	GRUESO 0.12 mm	SHIM 0.12 mm	SPESSORE 0.12 mm	CALE 0.12 mm
	PAT40-04000004-3	663-45567-20	GRUESO 0.15 mm	SHIM 0.15 mm	SPESSORE 0.15 mm	CALE 0.15 mm
	PAT40-04000004-5	663-45567-40	GRUESO 0.30 mm	SHIM 0.30 mm	SPESSORE 0.30 mm	CALE 0.30 mm
19	REC93332-00003	93332-00003	COJINETE	BEARING	CUSCINETTO	PALIER
20	REC66T-45560-00	66T-45560-01	PIÑÓN MARCHA AVANTE	POSITIVE GEAR ASSY	PIGNONE MARCIA AVANTI	PIGNON DE MARCHE AVANT
21	REC90250-06023	90250-06023	PASADOR	PIN	SPINOTTO	PIN
22	REC66T-45631-00	66T-45631-00	SELECTOR	CLUTCH BLOCK	SELETTORE	CRABOT
23	REC66T-45611-00	66T-45611-00	EJE HÉLICE	PROPELLER SHAFT	ASSE ELICA	ARBRE D'HELICE
24	REC90201-22429	90201-22429	ARANDELA	WASHER	RONDELLA	RONDELLE
25	REC66T-45571-00	66T-45571-00	PIÑÓN MARCHA ATRÁS	REVERSE GEAR	PIGNONE MARCIA INDIETRO	PIGNON MARCHE ARRIÈRE
	PAT40-04060005-2	63D-45577-10	GRUESO 0.12 mm	SHIM 0.12 mm	SPESSORE 0.12 mm	CALE 0.12 mm
	PAT40-04060005-3	63D-45577-20	GRUESO 0.15 mm	SHIM 0.15 mm	SPESSORE 0.15 mm	CALE 0.15 mm
26	PAT40-04060005-4	63D-45577-30	GRUESO 0.18 mm	SHIM 0.18 mm	SPESSORE 0.18 mm	CALE 0.18 mm
	PAT40-04060005-5	63D-45577-40	GRUESO 0.30 mm	SHIM 0.30 mm	SPESSORE 0.30 mm	CALE 0.30 mm
	PAT40-04060005-6	63D-45577-50	GRUESO 0.40 mm	SHIM 0.40 mm	SPESSORE 0.40 mm	CALE 0.40 mm
	PAT40-04060005-7	63D-45577-60	GRUESO 0.50 mm	SHIM 0.50 mm	SPESSORE 0.50 mm	CALE 0.50 mm
27	REC93306-001U1	93306-001U1	COJINETE	BEARING	CUSCINETTO	PALIER
28	REC93210-69MG6	93210-69MG6	TÓRICA	O-RING	O-RING	JOINT TORIQUE
29	REC93210-74MG5	93210-74MG5	TÓRICA	O-RING	O-RING	JOINT TORIQUE
30	REC63D-45361-02-4D	63D-45361-02-4D	DIÁBOLO	CAP, LOWER CASING	COPERCHIO CARTER INFERIORE	DIABOLO
31	REC93317-22204	93317-22204	COJINETE	BEARING	CUSCINETTO	PALIER
32	REC93101-22M00	93101-22M00	RETÉN DE ACEITE	OIL SEAL	PARAOLIO	JOINT SPI
33	REC663-45987-00	663-45987-02	ESPACIADOR	SPACER	DISTANZIALE	ENTRETOISE
34	REC66T-45997-00	66T-45997-00	ESPACIADOR	SPACER	DISTANZIALE	ENTRETOISE
35	REC90389-22M01	90389-22M01	CASQUILLO HÉLICE	WASHER	GHIERA ELICA	RONDELLE D'HELICE
36	REC90171-16011	90171-16011	TUERCA	LOCK NUT	DADO	ÉCROU
37	REC91490-30025	91490-30025	PASADOR	PIN	SPINOTTO	LEVIER

4T F30A/E/M • F40B/E/T  
STROKES

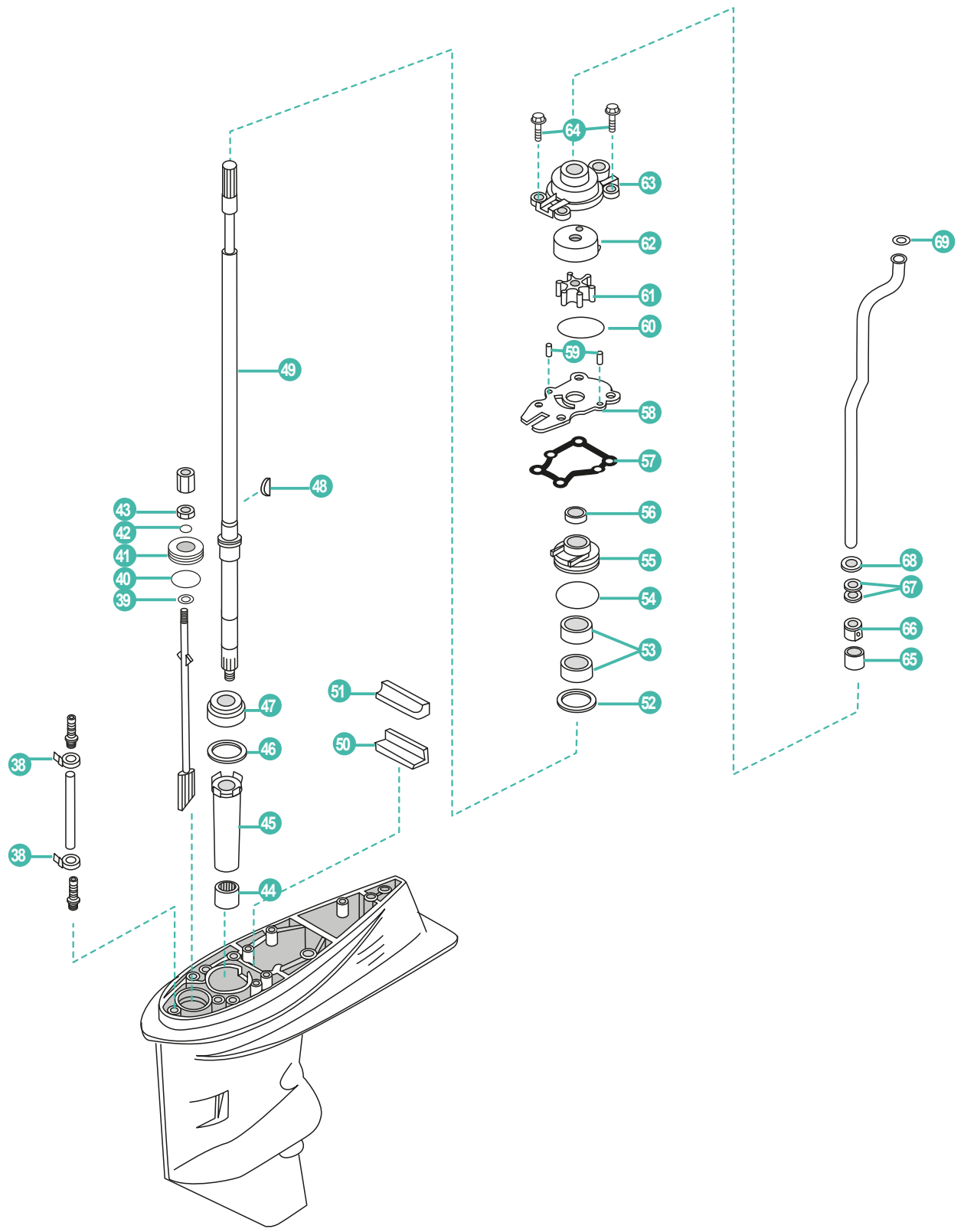

	REF	OEM				
38	PAHT-2.5X60	90465-11M10	BRIDA	CLAMP	FLANGIA	COLLIER
39	PAGB/T97.1-6	92990-06600	ARANDELA	WASHER	RONDELLA	RONDELLE
40	REC93210-33MG4	93210-33MG4	TÓRICA	O-RING	O-RING	JOINT TORIQUE
41	PAT40-04000007	66T-45321-00	PLACA	COVER PLATE, CAMSHAFT	PLACCA	COUVERCLE
42	REC93210-06ME6	93210-06ME6	TÓRICA	O-RING	O-RING	JOINT TORIQUE
43	REC95380-06700	95380-06700	TUERCA	LOCK NUT	DADO	ÉCROU
44	REC93315-32224	93315-32224	COJINETE	BEARING	CUSCINETTO	PALIER
45	PAT40-04000002	6H4-45536-00	CAMISA EJE	SLEEVE, DRIVE	TUBO GUIDA	BAGUE NYLON
	PAT40-04000003-1	663-45587-01	GRUESO 0.10 mm	SHIM 0.10 mm	SPESSORE 0.10 mm	CALE 0.10 mm
	PAT40-04000003-2	663-45587-10	GRUESO 0.12 mm	SHIM 0.12 mm	SPESSORE 0.12 mm	CALE 0.12 mm
	PAT40-04000003-3	663-45587-20	GRUESO 0.15 mm	SHIM 0.15 mm	SPESSORE 0.15 mm	CALE 0.15 mm
46	PAT40-04000003-4	663-45587-30	GRUESO 0.18 mm	SHIM 0.18 mm	SPESSORE 0.18 mm	CALE 0.18 mm
	PAT40-04000003-5	663-45587-40	GRUESO 0.30 mm	SHIM 0.30 mm	SPESSORE 0.30 mm	CALE 0.30 mm
	PAT40-04000003-6	663-45587-50	GRUESO 0.40 mm	SHIM 0.40 mm	SPESSORE 0.40 mm	CALE 0.40 mm
	PAT40-04000003-7	663-45587-60	GRUESO 0.50 mm	SHIM 0.50 mm	SPESSORE 0.50 mm	CALE 0.50 mm
47	REC93332-00001	93332-00001	COJINETE	BEARING	CUSCINETTO	ROULEMENT
48	REC90280-03M03	90280-03M03	CHAVETA	KEY WOODRUFF	CHIAVETTA	CLAVETTE
49	REC67C-45501-10	67C-45501-10	EJE VERTICAL L	DRIVE SHAFT L	ASSE VERTICALE L	ARBRE DE COMMANDE L
	REC67C-45501-00	67C-45501-00	EJE VERTICAL S	DRIVE SHAFT S	ASSE VERTICALE S	ARBRE DE COMMANDE S
50	REC663-45376-00	663-45376-00-94	GUÍA SELLO DE GOMA	GUIDE RUB. SEAL	GUIDA PARAOLIO	GUIDE
51	PAT40-04000014	63D-45375-00	SELLO DE GOMA	WATER ENVELOP	PARAOLIO	PROTECTION TUYAU D'EAU
52	PAT40-04000008	90201-27M00	ARANDELA	WASHER	RONDELLA	RONDELLE
53	REC93101-22M60	93101-22M60	RETÉN DE ACEITE	OIL SEAL	PARAOLIO	JOINT SPI
54	REC93210-48MG8	93210-48MG8	TÓRICA	O-RING	O-RING	JOINT TORIQUE
55	REC63D-44341-00	63D-44341-00	CUERPO BOMBA DE AGUA	SHELL, WATER PUMP	CORPO POMPA	INSERT POMPE À EAU
56	PAT40-04000009	66T-45344-01	CUBIERTA SELLO DE ACEITE	COVER, OIL SEAL	COPERCHIO, PARAOLIO	JOINT SPI
57	REC63D-44316-00	63D-44316-00	JUNTA	GASKET	GUARNIZIONE	JOINT
58	REC66T-44323-00	66T-44323-00	PLACA EXTERIOR	OUTER PLATE	PIASTRA POMPA ACQUA	PLAQUE DE POMPE À EAU
59	PAF25-04000007	93604-08062	PASADOR	PIN	SPINOTTO	PIN
60	REC93210-59MG7	93210-59MG7	TÓRICA	O-RING	O-RING	JOINT TORIQUE
61	REC6H4-44352-02	6H4-44352-02	TURBINA	IMPELLER	GIRANTE	TURBINE
62	REC63D-44322-00	63D-44322-00	TAPA, BOMBA AGUA	COVER, INNER WATER PUMP	COPERCHIO, POMPE ACQUA	COUVERCLE, POMPE D'EAU
63	PAT40-04000201	66T-44311-00	CUERPO BOMBA AGUA	HOUSING, WATER PUMP	CORPO POMPA	LOGEMENT POMPE D'EAU
64	REC90119-08M15	90119-08M15	TORNILLO CON ARANDELA	SCREW WITH WASHER	VITE CON RONDELLA	VIS AVEC RONDELLE
65	REC663-44366-00	663-44366-00	GOMA DEL SELLO DE AGUA	DAMPER, WATER SEAL	GHIERA	JOINT DE TUBE D'EAU
66	REC63D-44312-00	63D-44312-00	CUBIERTA CAJA DE BOMBA DE AGUA	PUMP COVER	COPERCHIO POMPA ACQUA	PLAQUE POMPE À EAU
67	PAT40-02000002	663-44367-00	GOMA DEL SELLO DE AGUA	GUIDE BUSHING, WATER PIPE	PARAOLIO	MAUCHON CAOUTCHOUC DE PIPE D'EAU
68	REC90430-12072	90430-12072	JUNTA	GASKET	GUARNIZIONE	JOINT
69	PAF25-02000019	90202-12060	ARANDELA PLANA	WASHER	RONDELLA PIANA	RONDELLE



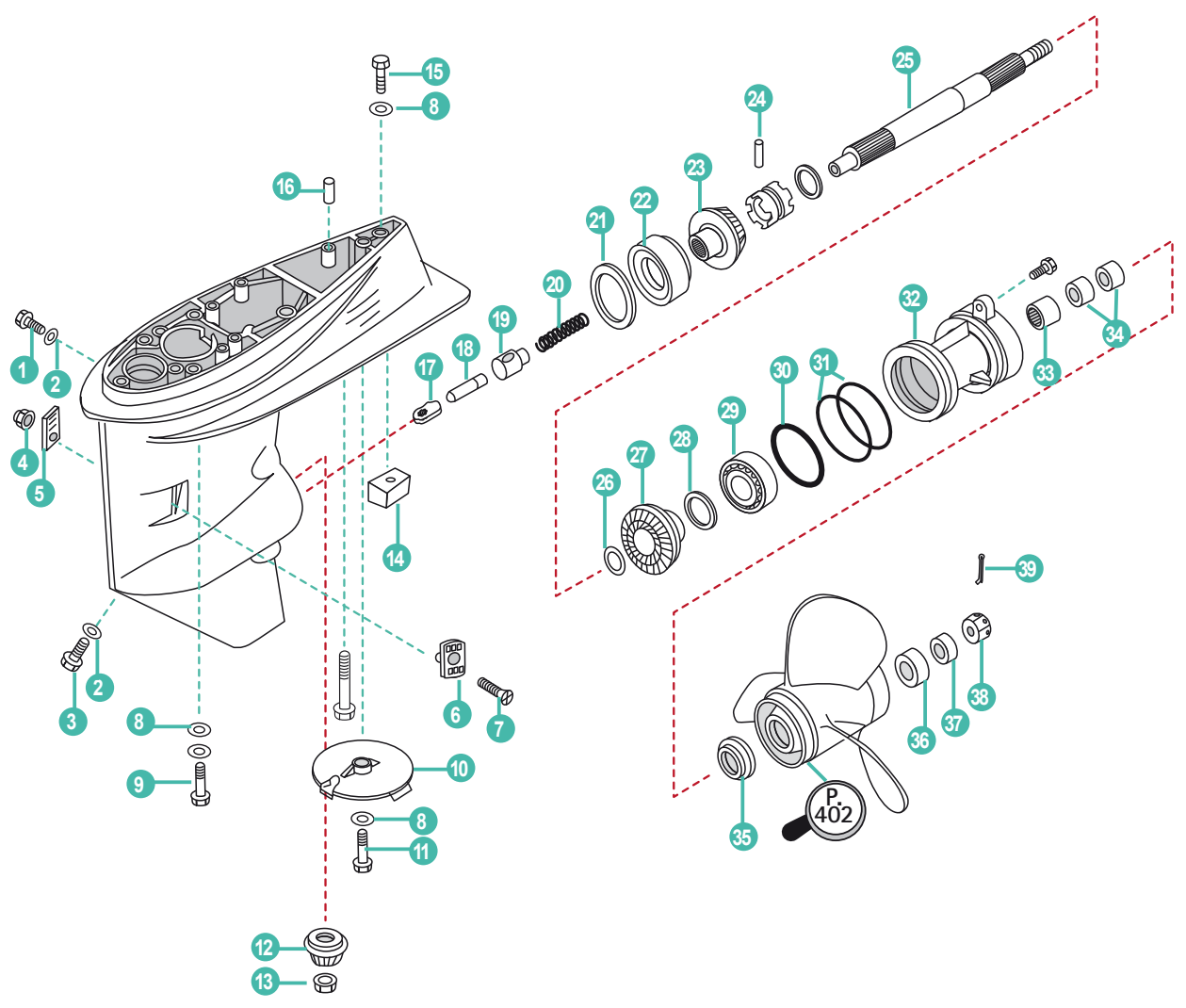

REF	OEM
REC6BG-W0078-00	6BG-W0078-00

P. 151

REF
REC80W90U3
REC80W90U6
RECGREU1
RECGREU12

P. 43

	REF	OEM				
1	REC90340-08002	90340-08002	TORNILLO DRENAJE	BOLT, DISCHARGING OIL	VITE DRENAGGIO	BOUCHON DE VIDANGE
2	REC90430-08020	90430-08003	JUNTA	GASKET	GUARNIZIONE	JOINT
3	REC688-45341-00	688-45341-10	TORNILLO DRENAJE	BOLT, DISCHARGING OIL	VITE DRENAGGIO	BOUCHON DE VIDANGE
4	PAGB/T889.1-M5	95380-05600	TUERCA	LOCK NUT	DADO	ÉCROU
5	PAT40-04000023	63D-45215-00	CUBIERTA ENTRADA AGUA B	WATER INLET B	COPERCHIO ACQUA B	GRILLE D'ENTREE D'EAU B
6	PAT40-04000022	63D-45214-00	CUBIERTA ENTRADA AGUA A	WATER INLET A	COPERCHIO ACQUA A	GRILLE D'ENTREE D'EAU A
7	PAGB/T820-M5X30	90152-05010	TORNILLO	SCREW	VITE	VIS
8	PAGB/T97.1-8	92995-10600	ARANDELA	WASHER	RONDELLA	RONDELLE
9	REC97075-10040	97075-10040	PERNO	STUD	BULLONE	BOULON
10	CM67C-45371-00A	67C-45371-00	ÁNODO	ANODE	ANODO	ANODE
11	PAGB/T5783-M8X25	97095-08025	PERNO	STUD	BULLONE	BOULON
12	REC66T-45551-00	66T-45551-00	PIÑÓN ATAQUE	INITIATIVE GEAR	MARCIA INIZIATIVA	PIGNON D'ATTAQUE
13	REC90170-12138	90170-12138	TUERCA	LOCK NUT	DADO	ÉCROU
14	CM67C-45251-00A	67C-45251-00	ÁNODO	ANODE	ANODO	ANODE
15	PAGB/T5783-M8X35	97095-08035	PERNO	STUD	BULLONE	BOULON
16	REC93606-12019	93606-12019	PASADOR	PIN	SPINOTTO	LEVIER
17	PAF60-04000003	62Y-44151-00	LEVA DE CAMBIO	SHIFTING CAM	LEVA CAMBIO	CAME DE CHANGEMENT
18	PAF60-04020005	63D-45635-00	ÉMBOLO	PLUNGER	BULLONE	BOUCHON
19	REC663-45634-00	663-45634-00	DESILIZADOR DEL CAMBIO	CLUTCH DOG	TRAINABILE CAMBIO	PIVOT
20	PAF60-04020002	90501-18001	MUELLE	SPRING	MOLLA	RESSORT
	PAT40-04000004-1	663-45567-01	GRUESO 0.10 mm	SHIM 0.10 mm	SPESSORE 0.10 mm	CALE 0.10 mm
21	PAT40-04000004-2	663-45567-10	GRUESO 0.12 mm	SHIM 0.12 mm	SPESSORE 0.12 mm	CALE 0.12 mm
	PAT40-04000004-3	663-45567-20	GRUESO 0.15 mm	SHIM 0.15 mm	SPESSORE 0.15 mm	CALE 0.15 mm
	PAT40-04000004-5	663-45567-40	GRUESO 0.30 mm	SHIM 0.30 mm	SPESSORE 0.30 mm	CALE 0.30 mm
22	REC93332-00003	93332-00003	COJINETE	BEARING	CUSCINETTO	ROULEMENT
23	REC66T-45560-00	66T-45560-01	PIÑÓN MARCHA AVANTE	POSITIVE GEAR ASSY	PIGNONE MARCIA AVANTI	PIGNON DE MARCHE AVANT
24	REC90250-06023	90250-06023	PASADOR	PIN	SPINOTTO	PIN
25	PAF60-04020001	63D-45611-00	EJE HÉLICE	PROPELLER SHAFT	ASSE ELICA	ARBRE D'HELICE
26	REC90201-22429	90201-22429	ARANDELA	WASHER	RONDELLA	RONDELLE
27	REC66T-45571-00	66T-45571-00	PIÑÓN MARCHA ATRÁS	REVERSE GEAR	PIGNONE MARCIA INDIETRO	PIGNON MARCHE ARRIÈRE
	PAT40-04060005-2	63D-45577-10	GRUESO 0.12 mm	SHIM 0.12 mm	SPESSORE 0.12 mm	CALE 0.12 mm
	PAT40-04060005-3	63D-45577-20	GRUESO 0.15 mm	SHIM 0.15 mm	SPESSORE 0.15 mm	CALE 0.15 mm
28	PAT40-04060005-4	63D-45577-30	GRUESO 0.18 mm	SHIM 0.18 mm	SPESSORE 0.18 mm	CALE 0.18 mm
	PAT40-04060005-5	63D-45577-40	GRUESO 0.30 mm	SHIM 0.30 mm	SPESSORE 0.30 mm	CALE 0.30 mm
	PAT40-04060005-6	63D-45577-50	GRUESO 0.40 mm	SHIM 0.40 mm	SPESSORE 0.40 mm	CALE 0.40 mm
	PAT40-04060005-7	63D-45577-60	GRUESO 0.50 mm	SHIM 0.50 mm	SPESSORE 0.50 mm	CALE 0.50 mm
29	REC93306-001U1	93306-001U1	COJINETE	BEARING	CUSCINETTO	ROULEMENT
30	REC93210-69MG6	93210-69MG6	TÓRICA	O-RING	O-RING	JOINT TORIQUE
31	REC93210-74MG5	93210-74MG5	TÓRICA	O-RING	O-RING	JOINT TORIQUE
32	REC63D-45361-02-4D	63D-45361-02-8D	DIÁBOLO	CAP, LOWER CASING	COPERCHIO CARTER INFERIORE	COUVERCLE, POMPE D'EAU
33	REC93317-22204	93317-22204	COJINETE	BEARING	CUSCINETTO	ROULEMENT
34	REC93101-22M00	93101-22M00	RETÉN DE ACEITE	OIL SEAL	PARAOLIO	JOINT SPI
35	REC663-45987-00	663-45987-02	ESPACIADOR	SPACER	DISTANZIALE	ENTRETOISE
36	REC66T-45997-00	66T-45997-00	ESPACIADOR	SPACER	DISTANZIALE	ENTRETOISE
37	REC90389-22M01	90389-22M01	CASQUILLO HELICE	WASHER	GHIERA ELICA	RONDELLE D'HELICE
38	REC90171-16011	90171-16011	TUERCA	LOCK NUT	DADO	ÉCROU
39	REC91490-30025	91490-30025	PASADOR	PIN	SPINOTTO	PIN

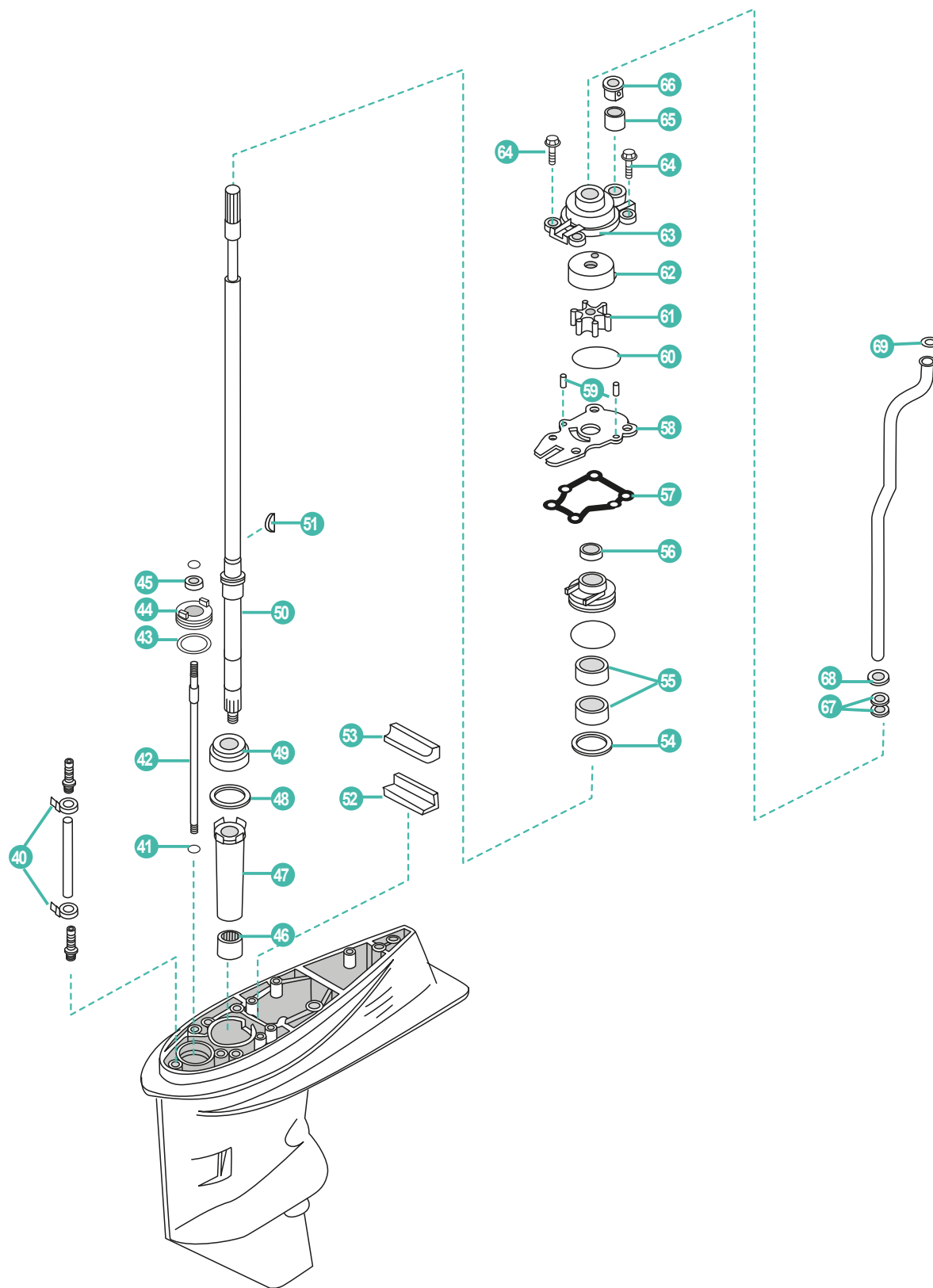

	REF	OEM				
40	PAHT-2.5X60	90465-11M10	BRIDA	CLAMP	FLANGIA	COLLIER
41	REC99001-08600-00	99001-08600	ARANDELA	WASHER	RONDELLA	RONDELLE
42	PA60-04000004	63D-44144-00	VARILLA DE CAMBIO	SHIFTING CAM	ASTA CAMBIO	LEVIER DE VITESSE
43	REC93210-33MG4	93210-33MG4	TÓRICA	O-RING	O-RING	JOINT TORIQUE
44	PAF60-04000101	63D-45321-00	PLACA	COVER, SHIFTING CAM	PACCA	SUPPORT
45	REC93106-09014	93106-09014	RETÉN DE ACEITE	OIL SEAL	PARAOLIO	JOINT SPI
46	REC93315-32224	93315-32224	COJINETE	BEARING	CUSCINETTO	ROULEMENT
47	PAT40-04000002	6H4-45536-00	CAMISA EJE	SLEEVE, DRIVE	TUBO GUIDA	RONDELLE
	PAT40-04000003-1	663-45587-01	GRUESO 0.10 mm	SHIM 0.10 mm	SPESSORE 0.10 mm	CALE 0.10 mm
	PAT40-04000003-2	663-45587-10	GRUESO 0.12 mm	SHIM 0.12 mm	SPESSORE 0.12 mm	CALE 0.12 mm
	PAT40-04000003-3	663-45587-20	GRUESO 0.15 mm	SHIM 0.15 mm	SPESSORE 0.15 mm	CALE 0.15 mm
48	PAT40-04000003-4	663-45587-30	GRUESO 0.18 mm	SHIM 0.18 mm	SPESSORE 0.18 mm	CALE 0.18 mm
	PAT40-04000003-5	663-45587-40	GRUESO 0.30 mm	SHIM 0.30 mm	SPESSORE 0.30 mm	CALE 0.30 mm
	PAT40-04000003-6	663-45587-50	GRUESO 0.40 mm	SHIM 0.40 mm	SPESSORE 0.40 mm	CALE 0.40 mm
	PAT40-04000003-7	663-45587-60	GRUESO 0.50 mm	SHIM 0.50 mm	SPESSORE 0.50 mm	CALE 0.50 mm
49	REC93332-00001	93332-00001	COJINETE	BEARING	CUSCINETTO	ROULEMENT
50	REC67C-45501-10	67C-45501-10	EJE VERTICAL L	DRIVE SHAFT L	ASSE VERTICALE L	ARBRE DE COMMANDE L
	REC67C-45501-00	67C-45501-00	EJE VERTICAL S	DRIVE SHAFT S	ASSE VERTICALE S	ARBRE DE COMMANDE S
51	REC90280-03M03	90280-03M03	CUÑA	KEY WOODRUFF	CHIAVETTA	CLAVETTE
52	REC663-45376-00	663-45376-00	GUÍA SELLO DE GOMA	GUIDE RUB. SEAL	GUIDA PARAOLIO	GUIDE EN CAOUTCHOUC
53	PAT40-04000014	63D-45375-00	SELLO DE GOMA	WATER ENVELOP	PARAOLIO	SUPPORT EN CAOUTCHOUC
54	PAT40-04000008	90201-27M00	ARANDELA	WASHER	RONDELLA	RONDELLE
55	REC93101-22M60	93101-22M60	RETÉN DE ACEITE	OIL SEAL	PARAOLIO	JOINT SPI
56	PAT40-04000009	66T-45344-01	CUBIERTA SELLO DE ACEITE	COVER, OIL SEAL	PARAOLIO	BAGUE EN CAOUTCHOUC
57	REC63D-44316-00	63D-44316-00	JUNTA	GASKET	GUARNIZIONE	JOINT
58	REC63D-44323-00	63D-44323-00	PLACA EXTERIOR	OUTER PLATE	PLACCA ESTERIORE	PLAQUE DE POMPE À EAU
59	PAF25-04000007	93604-08062	PASADOR	PIN	SPINOTTO	PIN
60	REC93210-59MG7	93210-59MG7	TÓRICA	O-RING	O-RING	JOINT TORIQUE
61	REC6H4-44352-02	6H4-44352-02	TURBINA	IMPELLER	GIRANTE	TURBINE
62	REC63D-44322-00	63D-44322-00	TAPA, BOMBA AGUA	COVER, INNER WATER PUMP	COPERCHIO, POMPE D'EAU	INSERT DE POMPE À EAU
63	PAT40-04000201	66T-44311-00	CUERPO BOMBA AGUA	HOUSING, WATER PUMP	CORPO POMPA	CORPS DE POMPE À EAU
64	REC90119-08M15	90119-08M15	TORNILLO CON ARANDELA	SCREW WITH WASHER	VITE CON RONDELLA	VIS PLUS RONDELLE
65	REC663-44366-00	663-44366-00	GOMA DEL SELLO DE AGUA	DAMPER, WATER SEAL	PARAOLIO	TUBE DE POMPE À EAU
66	REC63D-44312-00	63D-44312-00	CUBIERTA CAJA DE BOMBA DE AGUA	PUMP COVER	COPERCHIO CASSA POMPA ACQUA	BAGUE DE POMPE À EAU
67	PAT40-02000002	663-44367-00	GOMA DEL SELLO DE AGUA	DAMPER, WATER SEAL	PARAOLIO	JOINT
68	REC90430-12072	90430-12072	JUNTA	GASKET	GUARNIZIONE	JOINT
69	PAF25-02000019	90202-12060	ARANDELA PLANA	WASHER	RONDELLA PIANA	RONDELLE



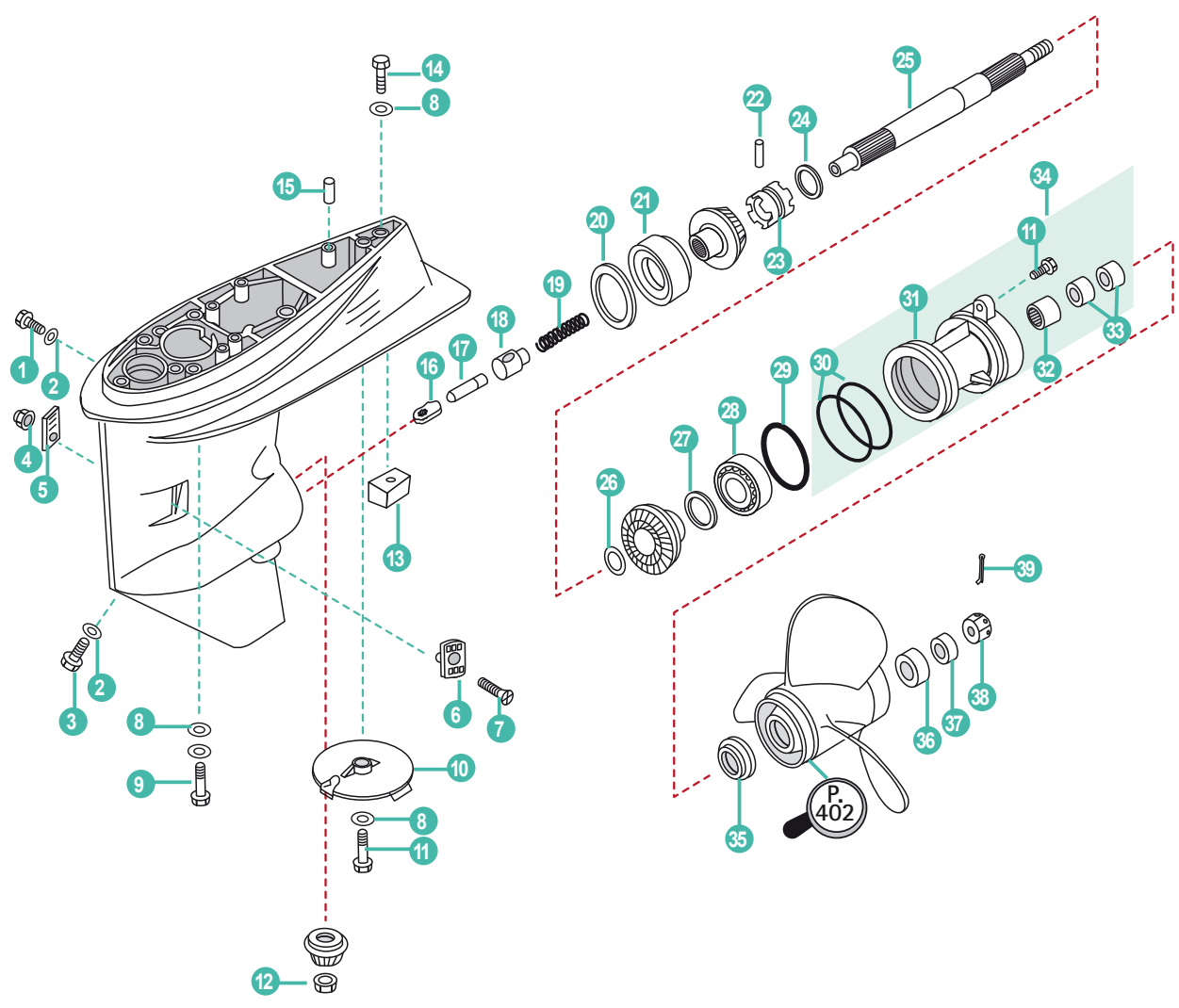

REF	OEM
REC62Y-W0001-22	62Y-W0001-22
P. 146	

REF	OEM
REC63D-W0078-01	63D-W0078-01
P. 151	

REF	
REC80W90U3 REC80W90U6 RECGREU1 RECGREU12	
P. 43	

	REF	OEM				
1	REC90340-08002	90340-08002	TORNILLO DRENAJE	BOLT, DISCHARGING OIL	VITE DRENAGGIO	BOUCHON DE VIDANGE
2	REC90430-08020	90430-08003	JUNTA	GASKET	GUARNIZIONE	JOINT
3	REC688-45341-00	688-45341-10	TORNILLO DRENAJE	BOLT, DISCHARGING OIL	VITE DRENAGGIO	BOUCHON DE VIDANGE
4	PAGB/T889.1-M5	95380-05600	TUERCA	LOCK NUT	DADO	ÉCROU
5	PAT40-04000023	63D-45215-00	CUBIERTA ENTRADA AGUA B	WATER INLET B	COPERCHIO ACQUA B	GRILLE D'ENTREE D'EAU B
6	PAT40-04000022	63D-45214-00	CUBIERTA ENTRADA AGUA A	WATER INLET A	COPERCHIO ACQUA A	GRILLE D'ENTREE D'EAU A
7	PAGB/T820-M5X30	90152-05M06	TORNILLO	SCREW	VITE	VIS
8	PAGB/T97.1-8	92995-10600	ARANDELA	WASHER	RONDELLA	RONDELLE
9	REC97075-10040	97075-10040	PERNO	STUD	BULLONE	BOULON
10	CM67C-45371-00A	67C-45371-00	ÁNODO	ANODE	ANODO	ANODE
11	PAGB/T5783-M8X25	97095-08025	PERNO	STUD	BULLONE	BOULON
12	REC90170-12138	90170-12138	TUERCA	LOCK NUT	DADO	ÉCROU
13	CM67C-45251-00A	67C-45251-00	ÁNODO	ANODE	ANODO	ANODE
14	PAGB/T5783-M8X35	97095-08035	PERNO	STUD	BULLONE	BOULON
15	REC93606-12019	93606-12019	PASADOR	PIN	SPINOTTO	PIN
16	PAF60-04000003	62Y-44151-00	LEVA DE CAMBIO	SHIFTING CAM	LEVA DE CAMBIO	CAME DE CHANGEMENT
17	PAF60-04020005	63D-45635-00	ÉMBOLO	PLUNGER	BULLONE	BOUCHON
18	REC663-45634-00	663-45634-00	DESILIZADOR DEL CAMBIO	CLUTCH DOG	TRAINABILE CAMBIO	PIVOT
19	PAF60-04020002	90501-18001	MUELLE	SPRING	MOLLA	RESSORT
	PAT40-04000004-1	663-45567-01	GRUESO 0.10 mm	SHIM 0.10 mm	SPESSORE 0.10 mm	CALE 0.10 mm
20	PAT40-04000004-2	663-45567-10	GRUESO 0.12 mm	SHIM 0.12 mm	SPESSORE 0.12 mm	CALE 0.12 mm
	PAT40-04000004-3	663-45567-20	GRUESO 0.15 mm	SHIM 0.15 mm	SPESSORE 0.15 mm	CALE 0.15 mm
	PAT40-04000004-5	663-45567-40	GRUESO 0.30 mm	SHIM 0.30 mm	SPESSORE 0.30 mm	CALE 0.30 mm
21	REC93332-00003	93332-00003	COJINETE	BEARING	CUSCINETTO	ROULEMENT
22	REC90250-06023	90250-06023	PASADOR	PIN	SPINOTTO	LEVIER
23	PAF60-04020003	62Y-45631-00	EMBRAGUE DE GARRA	CLUTCH DOG	SELETTORE	CRABOT
24	PAT40-04050005	67C-45633-00	ANILLO DEL PASADOR	ANNULAR SPRING, CLUTCH	PARAOLIO	RESSORT
25	PAF60-04020001	63D-45611-00	EJE HÉLICE	PROPELLER SHAFT	ASSE ELICA	ARBRE D'HELICE
26	REC90201-22429	90201-22429	ARANDELA	WASHER	RONDELLA	RONDELLE
	PAT40-04060005-2	63D-45577-10	GRUESO 0.12 mm	SHIM 0.12 mm	SPESSORE 0.12 mm	CALE 0.12 mm
	PAT40-04060005-3	63D-45577-20	GRUESO 0.15 mm	SHIM 0.15 mm	SPESSORE 0.15 mm	CALE 0.15 mm
27	PAT40-04060005-4	63D-45577-30	GRUESO 0.18 mm	SHIM 0.18 mm	SPESSORE 0.18 mm	CALE 0.18 mm
	PAT40-04060005-5	63D-45577-40	GRUESO 0.30 mm	SHIM 0.30 mm	SPESSORE 0.30 mm	CALE 0.30 mm
	PAT40-04060005-6	63D-45577-50	GRUESO 0.40 mm	SHIM 0.40 mm	SPESSORE 0.40 mm	CALE 0.40 mm
	PAT40-04060005-7	63D-45577-60	GRUESO 0.50 mm	SHIM 0.50 mm	SPESSORE 0.50 mm	CALE 0.50 mm
28	REC93306-001U1	93306-001U1	COJINETE	BEARING	CUSCINETTO	ROULEMENT
29	REC93210-69MG6	93210-69MG6	TÓRICA	O-RING	O-RING	JOINT TORIQUE
30	REC93210-74MG5	93210-74MG5	TÓRICA	O-RING	O-RING	JOINT TORIQUE
31	REC63D-45361-02-4D	63D-45361-02-4D	DIÁBOLO	CAP, LOWER CASING	COPERCHIO CARTER INFERIORE	DIABOLO
32	REC93317-22204	93317-22204	COJINETE	BEARING	CUSCINETTO	ROULEMENT
33	REC93101-22M00	93101-22M00	RETÉN DE ACEITE	OIL SEAL	PARAOLIO	JOINT SPI
34	PAF60-04030000	63D-45361-02-8D	FUNDA INFERIOR COMPLETA	COVER ASSY, LOWER CASING	COPERCHIO CARTER COMPLETA	DIABOLO COMPLET
35	REC663-45987-00	663-45987-02	ESPACIADOR	SPACER	DISTANZIALE	ENTRETOISE
36	REC66T-45997-00	667-45997-00	ESPACIADOR	SPACER	DISTANZIALE	ENTRETOISE
37	REC90389-22M01	90389-22M01	CASQUILLO HELICE	WASHER	GHIERA ELICA	RONDELLE D'HELICE
38	REC90171-16011	90171-16011	TUERCA	LOCK NUT	DADO	ÉCROU
39	REC91490-30025	91490-30025	PASADOR	PIN	SPINOTTO	CLAVETTE

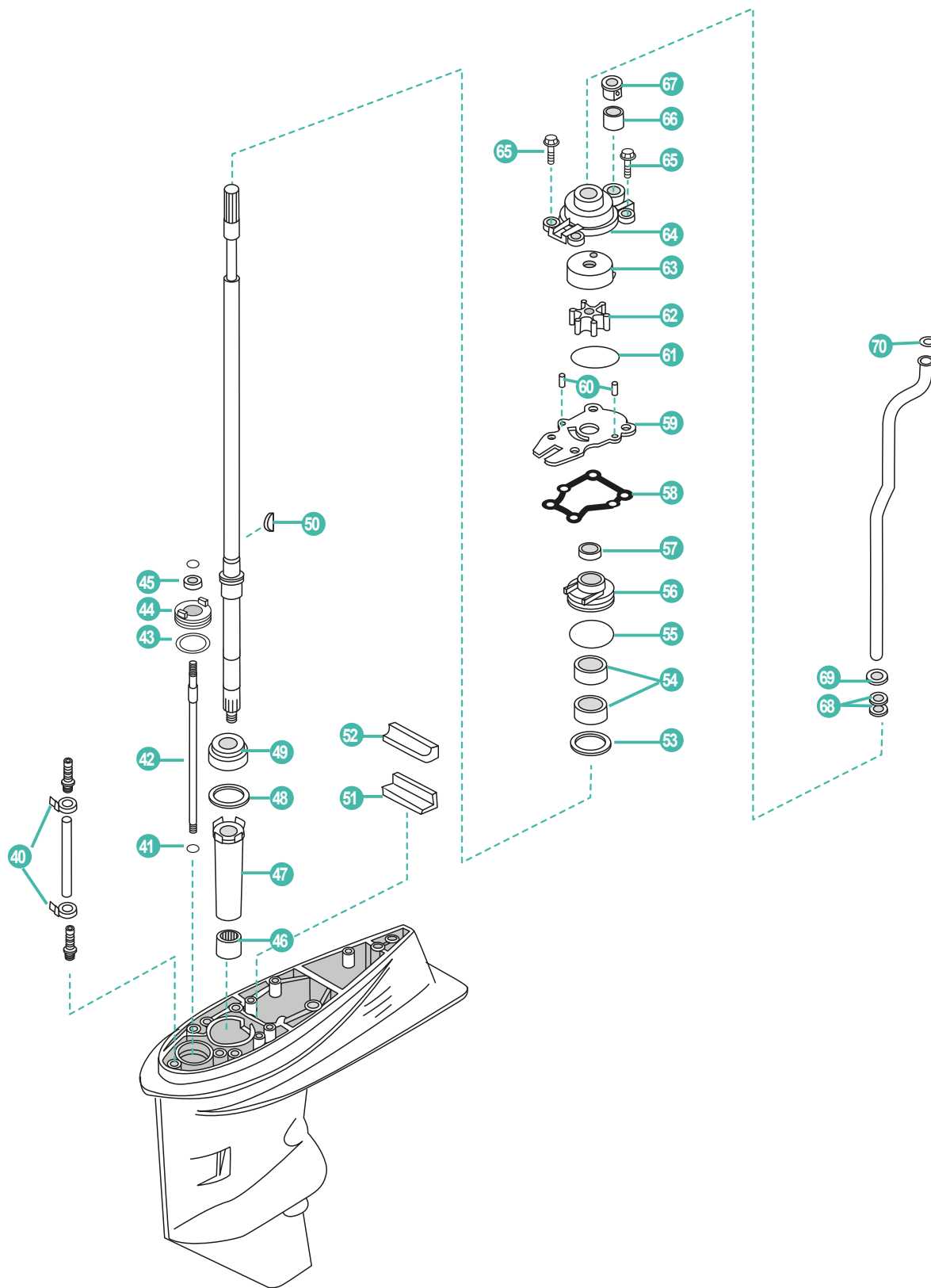

	REF	OEM				
40	PAHT-2.5X60	90465-11M10	BRIDA	CLAMP	FLANGIA	COLLIER
41	REC99001-08600-00	99001-08600	ARANDELA	WASHER	RONDELLA	RONDELLE
42	PA60-04000004	63D-44144-00	VARILLA DE CAMBIO	SHIFTING CAM	ASTA CAMBIO	LEVIER DE VITESSE
43	REC93210-33MG4	93210-33MG4	TÓRICA	O-RING	O-RING	JOINT TORIQUE
44	PAF60-04000101	63D-45321-00	PLACA	COVER, SHIFTING CAM	PLACCA	SUPPORT
45	REC93106-09014	93106-09014	RETÉN DE ACEITE	OIL SEAL	PARAOLIO	JOINT SPI
46	REC93315-32224	93315-32224	COJINETE	BEARING	CUSCINETTO	ROULEMENT
47	PAT40-04000002	6H4-45536-00	CAMISA EJE	SLEEVE, DRIVE	TUBO GUIDA	BAGUE NYLON
	PAT40-04000003-1	663-45587-01	GRUESO 0.10 mm	SHIM 0.10 mm	SPESSORE 0.10 mm	CALE 0.10 mm
	PAT40-04000003-2	663-45587-10	GRUESO 0.12 mm	SHIM 0.12 mm	SPESSORE 0.12 mm	CALE 0.12 mm
	PAT40-04000003-3	663-45587-20	GRUESO 0.15 mm	SHIM 0.15 mm	SPESSORE 0.15 mm	CALE 0.15 mm
48	PAT40-04000003-4	663-45587-30	GRUESO 0.18 mm	SHIM 0.18 mm	SPESSORE 0.18 mm	CALE 0.18 mm
	PAT40-04000003-5	663-45587-40	GRUESO 0.30 mm	SHIM 0.30 mm	SPESSORE 0.30 mm	CALE 0.30 mm
	PAT40-04000003-6	663-45587-50	GRUESO 0.40 mm	SHIM 0.40 mm	SPESSORE 0.40 mm	CALE 0.40 mm
	PAT40-04000003-7	663-45587-60	GRUESO 0.50 mm	SHIM 0.50 mm	SPESSORE 0.50 mm	CALE 0.50 mm
49	REC93332-00001	93332-00001	COJINETE	BEARING	CUSCINETTO	ROULEMENT
50	REC90280-03024	90280-03024	CUÑA	KEY WOODRUFF	CHIAVETTA	CLAVETTE
51	REC663-45376-00	663-45376-00-94	GUIÁ SELLO DE GOMA	GUIDE RUB SEAL	GUIDA PARAOLIO	GUIDE
52	PAT40-04000014	63D-45375-00	SELLO DE GOMA	WATER ENVELOP	PARAOLIO	PROTECTION TUYAU D'EAU
53	PAT40-04000008	90201-27M00	ARANDELA	WASHER	RONDELLA	RONDELLE
54	REC93101-25M57	93101-25M57	RETÉN DE ACEITE	OIL SEAL	PARAOLIO	JOINT SPI
55	REC93210-48MG8	93210-48MG8	TÓRICA	O-RING	O-RING	JOINT TORIQUE
56	REC63D-44341-00	63D-44341-00	CAJA DE BOMBA	HOUSING PUMP	CASSA POMPA	BOITIER DE POMPE À EAU
57	PAT40-04000009	66T-45344-01	CUBIERTA SELLO DE ACEITE	COVER SEAL OIL	COPERCHIO PARAOLIO	JOINT SPI
58	REC63D-44316-00	63D-44316-00	JUNTA	GASKET	GUARNIZIONE	JOINT
59	REC63D-44323-00	63D-44323-00	PLACA EXTERIOR	OUTER PLATE	PIASTRA POMPA ACQUA	PLAQUE DE POMPE À EAU
60	PAF25-04000007	93604-08062	PASADOR	PIN	SPINOTTO	PIN
61	REC93210-59MG7	93210-59MG7	TÓRICA	O-RING	O-RING	JOINT TORIQUE
62	REC6H4-44352-02	6H4-44352-00	TURBINA	IMPELLER	GIRANTE	TURBINE
63	REC63D-44322-00	63D-44322-00	TAPA, BOMBA AGUA	COVER, INNER WATER PUMP	COPERCHIO, POMPA ACQUA	INSERT DE POMPE À EAU
64	REC63D-44311-01	63D-44311-00	CUERPO BOMBA AGUA	HOUSING, WATER PUMP	CORPO POMPA	CORPS DE POMPE À EAU
65	REC90119-08M15	90119-08M15	TORNILLO CON ARANDELA	SCREW WITH WASHER	VITE CON RONDELLA	VIS AVEC RONDELLE
66	REC663-44366-00	663-44366-00	GOMA DEL SELLO DE AGUA	GUIDE BUSHING, WATER PIPE	PARAOLIO	MAUCHON CAOUTCHOUC DE PIPE D'EAU
67	REC63D-44312-00	63D-44312-00	CUBIERTA CAJA DE BOMBA DE AGUA	PUMP COVER	COPERCHIO CORPO ACQUA	PLAQUE POMPE À EAU
68	PAT40-02000002	663-44367-00	GOMA DEL SELLO DE AGUA	GUIDE BUSHING, WATER PIPE	PARAOLIO	JOINT CAHOUTCHOUC
69	REC90430-12072	90430-12072	JUNTA	GASKET	GUARNIZIONE	JOINT
70	PAF25-02000019	90202-12060	ARANDELA PLANA	WASHER	RONDELLA PIANA	RONDELLE



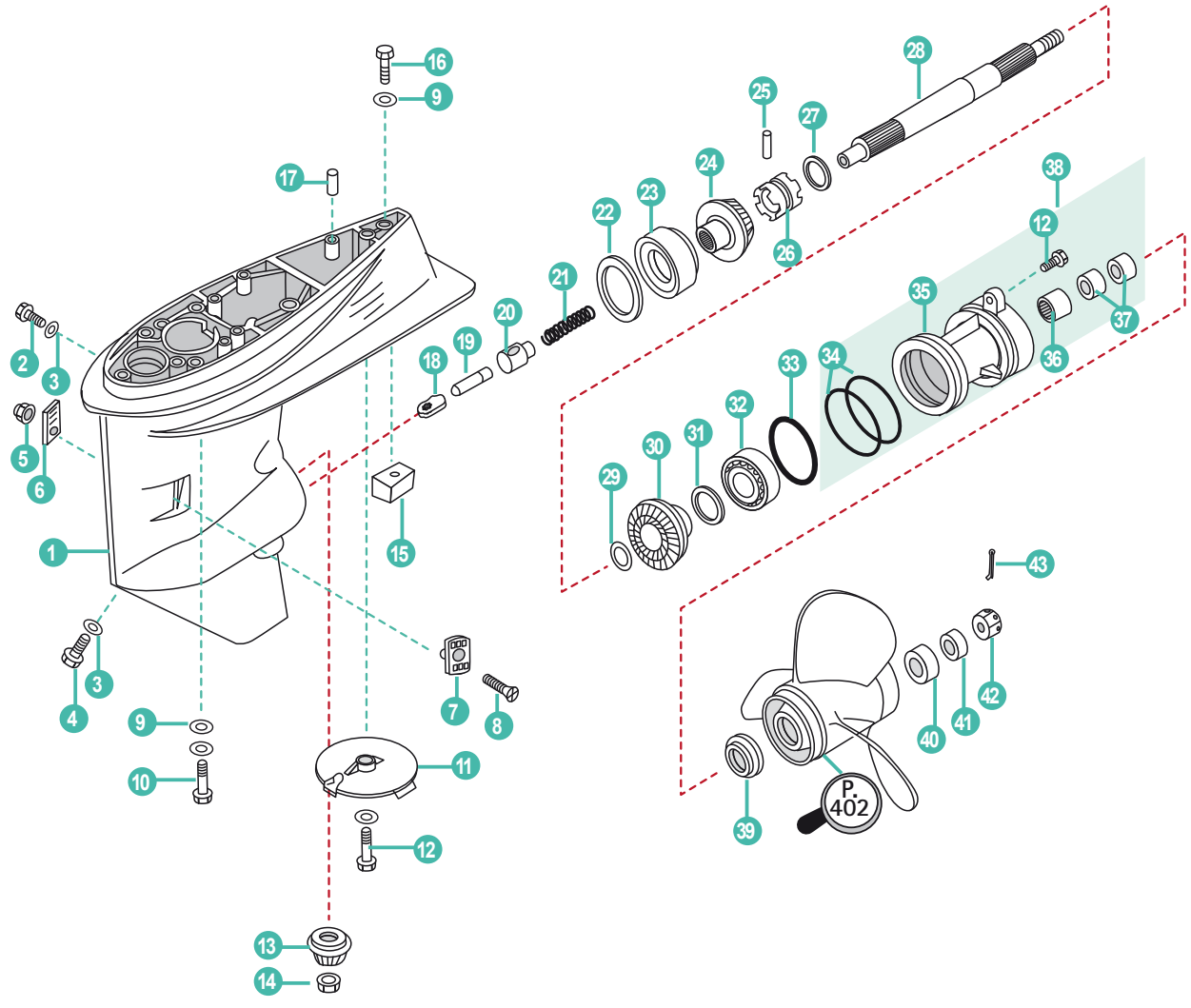

REF	OEM
REC63D-W0078-01	63D-W0078-01

P. 151

REF
REC80W90U3
REC80W90U6
RECGREU1
RECGREU12

P. 43

	REF	OEM				
	PAF60-04000000	69W-45300-04-8D COLA COMPLETA L	COMPLETE GEAR HOUSING L	PIEDE COMPLETO L	EMBASE COMPLETE L	
1	PAF60-04000001	69W-45301-00-8D CARCASA COMPLETA	LOWER CASING	CARCASSA COMPLETA	CARTER D'EMBASE	
2	REC90340-08002	90340-08002 TORNILLO DRENAJE	BOLT, DISCHARGING OIL	VITE DRENAGGIO	BOUCHON DE VIDANGE	
3	REC90430-08020	90430-08003 JUNTA	GASKET	GUARNIZIONE	JOINT	
4	REC688-45341-00	688-45341-10 TORNILLO DRENAJE	BOLT, DISCHARGING OIL	VITE DRENAGGIO	VIS DE VIDANGE	
5	PAGB/T889.1-M5	95380-05600 TUERCA	LOCK NUT	DADO	ÉCROU	
6	PAT40-04000023	63D-45215-00 CUBIERTA ENTRADA AGUA B	WATER INLET B	COPERCHIO ACQUA B	GRILLE D'ENTREE D'EAU B	
7	PAT40-04000022	63D-45214-00 CUBIERTA ENTRADA AGUA A	WATER INLET A	COPERCHIO ACQUA A	GRILLE D'ENTREE D'EAU A	
8	PAGB/T820-M5X30	90152-05010 TORNILLO	SCREW	VITE	VIS	
9	PAGB/T97.1-8	92995-10600 ARANDELA	WASHER	RONDELLA	RONDELLE	
10	REC97075-10040	97075-10040 PERNO	STUD	BULLONE	BOULON	
11	CM67C-45371-00A	67C-45371-00 ÁNODO	ANODE	ANODO	ANODE	
12	PAGB/T5783-M8X25	97095-08025 PERNO	STUD	BULLONE	BOULON	
13	PAF60-04000002	69W-45551-00 PIÑÓN ATAQUE	INITIATIVE GEAR	MARCIA INIZIATIVA	PIGNON D'ATTAQUE	
14	REC90170-12138	90170-12138 TUERCA	LOCK NUT	DADO	ÉCROU	
15	CM67C-45251-00A	67C-45251-00 ÁNODO	ANODE	ANODO	ANODE	
16	PAGB/T5783-M8X35	97095-08035 PERNO	STUD	BULLONE	BOULON	
17	REC93606-12019	93606-12019 PASADOR	PIN	SPINOTTO	PIN	
18	PAF60-04000003	62Y-44151-00 LEVA DE CAMBIO	SHINFTING CAM	LEVA DE CAMBIO	CAME DE CHANGEMENT	
19	PAF60-04020005	63D-45635-00 ÉMBOLO	PLUNGER	BULLONE	BOUCHON	
20	REC663-45634-00	663-45634-00 DESLIZADOR DEL CAMBIO	CLUTCH DOG	TRAINABILE CAMBIO	PIVOT	
21	PAF60-04020002	90501-18001 MUELLE	SPRING	MOLLA	RESSORT	
	PAT40-04000004-1	663-45567-01 GRUESO 0.10 mm	SHIM 0.10 mm	SPESSORE 0.10 mm	CALE 0.10 mm	
	PAT40-04000004-2	663-45567-10 GRUESO 0.12 mm	SHIM 0.12 mm	SPESSORE 0.12 mm	CALE 0.12 mm	
	PAT40-04000004-3	663-45567-20 GRUESO 0.15 mm	SHIM 0.15 mm	SPESSORE 0.15 mm	CALE 0.15 mm	
	PAT40-04000004-5	663-45567-40 GRUESO 0.30 mm	SHIM 0.30 mm	SPESSORE 0.30 mm	CALE 0.30 mm	
23	PAKOYOH1-CAP322/32	93332-00092 COJINETE	BEARING	CUSCINETTO	ROULEMENT	
24	PAF60-04000600	69W-45560-00 PIÑÓN MARCHA AVANTE	POSITIVE GEAR ASSY	PIGNONE MARCIA AVANTI	PIGNON DE MARCHE AVANT	
25	REC90250-06023	90250-06023 PASADOR	PIN	SPINOTTO	LEVIER	
26	PAF60-04020003	62Y-45631-00 EMBRAGUE DE GARRA	CLUTCH DOG	SELETTORE	CRABOT	
27	PAT40-04050005	67C-45633-00 ANILLO DEL PASADOR	ANNULAR SPRING, CLUTCH	PARAOLIO	RESSORT	
28	PAF60-04020001	63D-45611-00 EJE HÉLICE	PROPELLER SHAFT	ASSE ELICA	ARBRE D'HELICE	
29	PAT40-04050007	90201-22008 ARANDELA	WASHER	RONDELLA	RONDELLE	
30	PAF60-04000500	62Y-45571-00 PIÑÓN MARCHA ATRÁS	REVERSE GEAR	PIGNONE MARCIA INDIETRO	PIGNON MARCHE ARRIÈRE	
	PAT40-04060005-2	63D-45577-10 GRUESO 0.12 mm	SHIM 0.12 mm	SPESSORE 0.12 mm	CALE 0.12 mm	
	PAT40-04060005-3	63D-45577-20 GRUESO 0.15 mm	SHIM 0.15 mm	SPESSORE 0.15 mm	CALE 0.15 mm	
	PAT40-04060005-4	63D-45577-30 GRUESO 0.18 mm	SHIM 0.18 mm	SPESSORE 0.18 mm	CALE 0.18 mm	
	PAT40-04060005-5	63D-45577-40 GRUESO 0.30 mm	SHIM 0.30 mm	SPESSORE 0.30 mm	CALE 0.30 mm	
	PAT40-04060005-6	63D-45577-50 GRUESO 0.40 mm	SHIM 0.40 mm	SPESSORE 0.40 mm	CALE 0.40 mm	
	PAT40-04060005-7	63D-45577-60 GRUESO 0.50 mm	SHIM 0.50 mm	SPESSORE 0.50 mm	CALE 0.50 mm	
32	REC93306-001U1	93306-001U1 COJINETE	BEARING	CUSCINETTO	ROULEMENT	
33	REC93210-69MG6	93210-69MG6 TÓRICA	O-RING	O-RING	JOINT TORIQUE	
34	REC93210-74MG5	93210-74MG5 TÓRICA	O-RING	O-RING	JOINT TORIQUE	
35	REC63D-45361-02-8D	63D-45361-02-8D DIÁBOLO	CAP, LOWER CASING	COPERCHIO CARTER INFERIORE	COUVERCLE, POMPE D'EAU	
36	REC93317-22204	93317-22204 COJINETE	BEARING	CUSCINETTO	PALIER	
37	REC93101-22M00	93101-22M00 RETÉN DE ACEITE	OIL SEAL	PARAOLIO	JOINT SPI	
38	PAF60-04030000	63D-45361-02-8D FUNDA INFERIOR COMPLETA	COVER ASSY, LOWER CASING	COPERCHIO CARTER COMPLETA	COUVERCLE INFERIEUR EMBASE	
39	REC663-45987-00	663-45987-02 ESPACIADOR	SPACER	DISTANZIALE	ENTRETOISE	
40	REC66T-45997-00	667-45997-00 ESPACIADOR	SPACER	DISTANZIALE	ENTRETOISE	
41	REC90389-22M01	90389-22M01 CASQUILLO HÉLICE	WASHER	GHIERA ELICA	RONDELLE D'HELICE	
42	REC90171-16011	90171-16011 TUERCA	LOCK NUT	DADO	ÉCROU	
43	REC91490-30025	91490-30025 PASADOR	PIN	SPINOTTO	CLAVETTE	

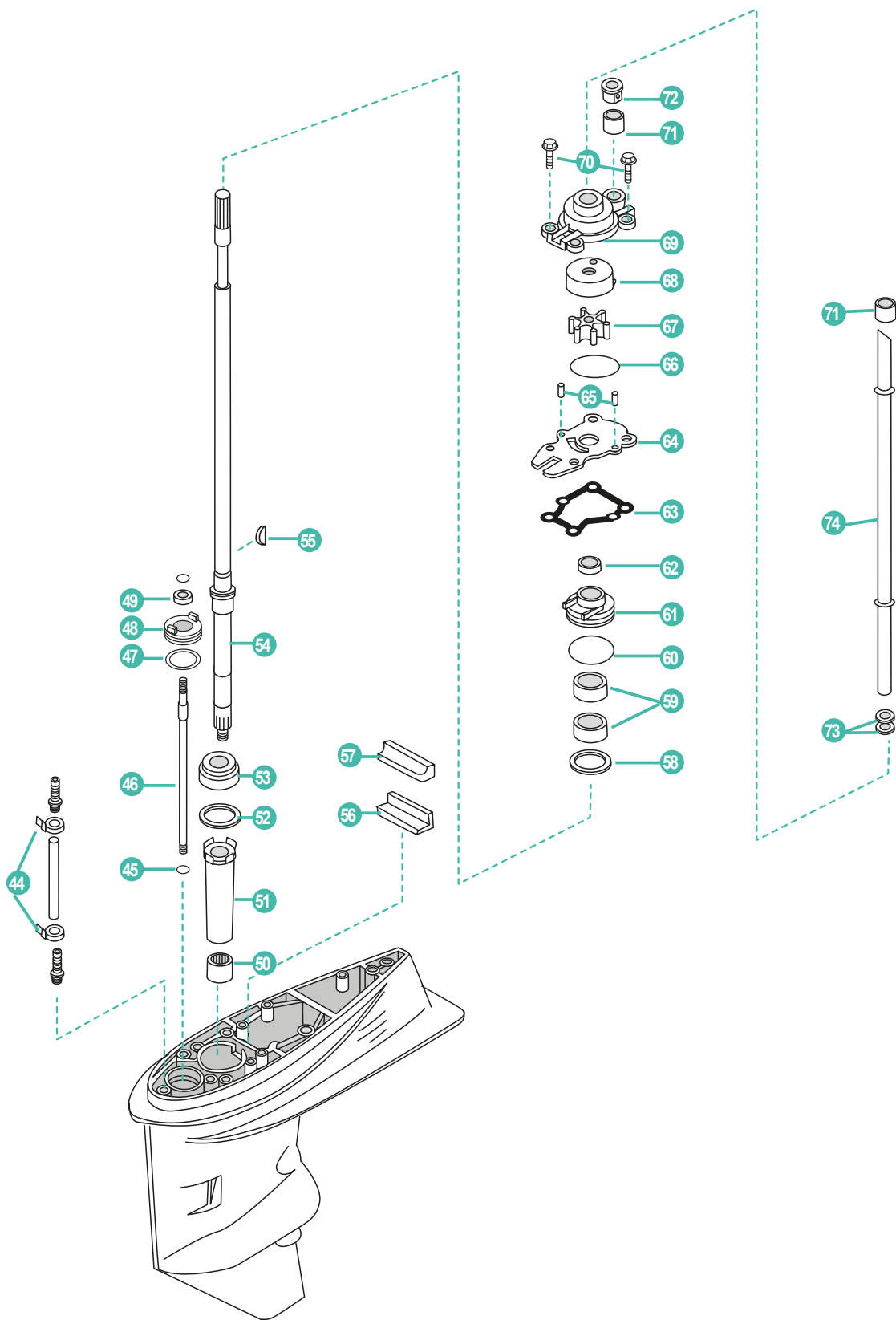

	REF	OEM				
44	PAHT-2.5X60	90465-11M10	BRIDA	CLAMP	FLANGIA	COLLIER
45	REC99001-08600-00	99001-08600	ARANDELA	WASHER	RONDELLA	RONDELLE
46	PA60-04000004	63D-44144-00	VARILLA DE CAMBIO	SHIFTING CAM	ASTICELLA DEL CAMBIO	CAME DE CHANGEMENT
47	REC93210-33MG4	93210-33MG4	TÓRICA	O-RING	O-RING	JOINT TORIQUE
48	PAF60-04000101	63D-45321-00	PLACA	COVER, SHIFTING CAM	PLACCA	SUPPORT
49	REC93106-09014	93106-09014	RETÉN DE ACEITE	OIL SEAL	PARAOLIO	JOINT SPI
50	REC93315-32224	93315-32224	COJINETE	BEARING	CUSCINETTO	PALIER
51	PAT40-04000002	6H4-45536-00	CAMISA EJE	SLEEVE, DRIVE	TUBO GUIDA	RONDELLE
	PAT40-04000003-1	663-45587-01	GRUESO 0.10 mm	SHIM 0.10 mm	SPESSORE 0.10 mm	CALE 0.10 mm
	PAT40-04000003-2	663-45587-10	GRUESO 0.12 mm	SHIM 0.12 mm	SPESSORE 0.12 mm	CALE 0.12 mm
	PAT40-04000003-3	663-45587-20	GRUESO 0.15 mm	SHIM 0.15 mm	SPESSORE 0.15 mm	CALE 0.15 mm
52	PAT40-04000003-4	663-45587-30	GRUESO 0.18 mm	SHIM 0.18 mm	SPESSORE 0.18 mm	CALE 0.18 mm
	PAT40-04000003-5	663-45587-40	GRUESO 0.30 mm	SHIM 0.30 mm	SPESSORE 0.30 mm	CALE 0.30 mm
	PAT40-04000003-6	663-45587-50	GRUESO 0.40 mm	SHIM 0.40 mm	SPESSORE 0.40 mm	CALE 0.40 mm
	PAT40-04000003-7	663-45587-60	GRUESO 0.50 mm	SHIM 0.50 mm	SPESSORE 0.50 mm	CALE 0.50 mm
53	REC93332-00001	93332-00001	COJINETE	BEARING	CUSCINETTO	ROULEMENT
54	PAF60-04010000	69W-45501-00	EJE VERTICAL COMPLETO	DRIVE SHAFT	ASSE VERTICALE	ARBRE DE COMMANDE
55	REC90280-03024	90280-03024	CUÑA	KEY WOODRUFF	CHIAVETTA	CLAVETTE
56	REC663-45376-00	663-45376-00-94	GUÍA SELLO DE GOMA	GUIDE RUB. SEAL	GUIDA PARAOLIO	GUIDE
57	PAT40-04000014	63D-45375-00	SELLO DE GOMA	WATER ENVELOP	PARAOLIO	PROTECTION TUYAU D'EAU
58	PAT40-04000008	90201-27M00	ARANDELA	WASHER	RONDELLA	RONDELLE
59	REC93101-25M57	93101-25M57	RETÉN DE ACEITE	OIL SEAL	PARAOLIO	JOINT SPI
60	PAJASOF40424-050	93210-48001	TÓRICA	O-RING	O-RING	JOINT TORIQUE
61	PAT40-04040001	6BG-44341-00	CAJA DE BOMBA	CASING A, OIL SEAL	CASSA POMPA	LOGEMENT JOINT SPI
62	PAF60-04000008	63D-45344-00	CUBIERTA SELLO DE ACEITE	COVER, OIL SEAL	PARAOLIO	COUVERTURE JOINT D'HUILE
63	REC63D-44316-00	63D-44316-00	JUNTA	GASKET	GUARNIZIONE	JOINT
64	REC63D-44323-00	63D-44323-00	PLACA EXTERIOR	WATER PLATE	PLACCA ESTERNA	PLAQUE DE POMPE À EAU
65	PAF25-04000007	93604-08062	PASADOR	PIN	SPINOTTO	LEVIER
66	REC93210-59MG7	93210-59MG7	TÓRICA	O-RING	O-RING	JOINT TORIQUE
67	REC6H3-44352-00	6H3-44352-00	TURBINA	IMPELLER	GIRANTE	TURBINE
68	REC63D-44322-00	63D-44322-00	TAPA, BOMBA AGUA	COVER, INNER WATER PUMP	COPERCHIO, POMPE D'EAU	INSERT DE POMPE À EAU
69	REC63D-44311-01	63D-44311-00	CUERPO BOMBA AGUA	HOUSING, WATER PUMP	CORPO POMPA	CORPS DE POMPE À EAU
70	REC90119-08M15	90119-08M15	TORNILLO CON ARANDELA	SCREW WITH WASHER	VITE CON RONDELLA	VIS AVEC RONDELLE
71	REC663-44366-00	663-44366-00	GOMA DEL SELLO DE AGUA	GUIDE BUSHING, WATER PIPE	PARAOLIO	GUIDE CAOUTCHOUC
72	REC63D-44312-00	63D-44312-00	CUBIERTA CAJA DE BOMBA DE AGUA	PUMP COVER	COPERCHIO CORPO ACQUA	PLAQUE POMPE À EAU
73	PAT40-02000002	663-44367-00	GOMA DEL SELLO DE AGUA	GUIDE BUSHING, WATER PIPE	PARAOLIO	JOINT CAOUTCHOUC
74	PAF60-02000007	6C5-44361-00	TUBO DE AGUA	WATER TUBE	TUBO DELL'ACQUA	DURITE D'EAU



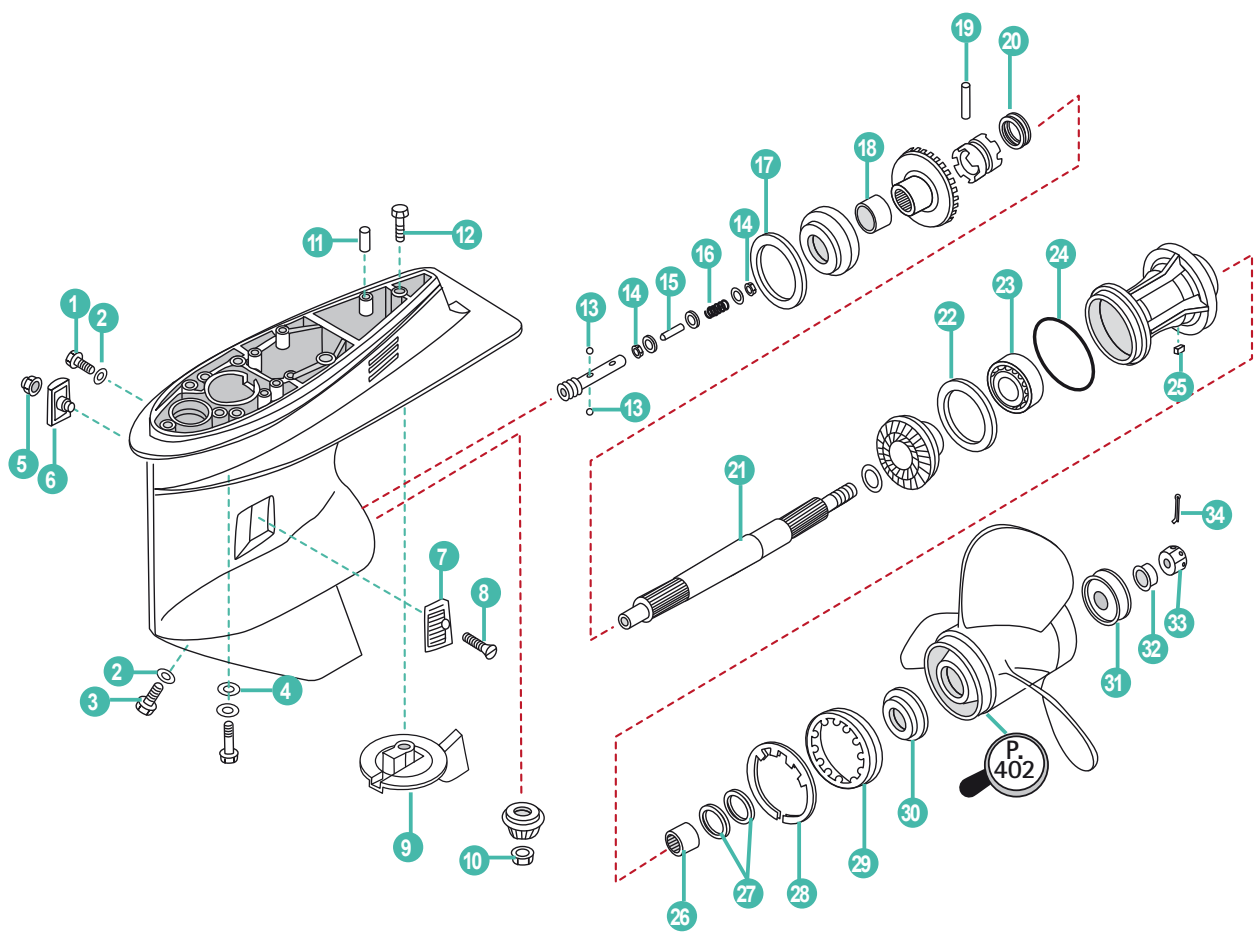

REF	OEM
REC6CJ-W0078-00	6CJ-W0078-00

P. 151

REF
REC80W90U3
REC80W90U6
RECGREU1
RECGREU12

P. 43

	REF	OEM				
1	REC90340-08002	90340-08002	TORNILLO DRENAJE	BOLT, DISCHARGING OIL	VITE DRENAGGIO	BOUCHON DE VIDANGE
2	REC90430-08020	90430-08003	JUNTA	GASKET	GUARNIZIONE	JOINT
3	REC688-45341-00	688-45341-10	TORNILLO DRENAJE	BOLT, DISCHARGING OIL	VITE DRENAGGIO	BOUCHON DE VIDANGE
4	PAGB/T97.1-8	92995-10600	ARANDELA	WASHER	RONDELLA	RONDELLE
5	PAGB/T6182-M5	90185-05002	TUERCA	LOCK NUT	DADO	ÉCROU
6	REC6H1-45215-00	6H1-45215-00	CUBIERTA ENTRADA AGUA B	WATER INLET B	COPERCHIO ACQUA B	GRILLE D'ENTREE D'EAU B
7	REC6H1-45214-00	6H1-45214-00	CUBIERTA ENTRADA AGUA A	WATER INLET A	COPERCHIO ACQUA A	GRILLE D'ENTREE D'EAU A
8	REC90151-05M00	90152-05000	TORNILLO	SCREW	VITE	VIS
9	CM67F-45371-00A	67F-45371-00	ÁNODO	ANODE	ANODO	ANODE
10	REC90170-16M01	90170-16M01	TUERCA	LOCK NUT	DADO	ÉCROU
11	REC93606-12019	93606-12019	PASADOR	PIN	SPINOTTO	LEVIER
12	PAT85-00000012	90105-16M67	PERNO	STUD	BULLONE	BOULON
13	REC93503-16003	93503-16003	ESFERA	BALL	SFERA	BILLE
14	REC90183-02M03	90183-02M03	TUERCA	LOCK NUT	DADO	ÉCROU
15	REC6H1-45668-00	6H1-45668-00	EJE DEL ÉMBOLO	FREE SHAFT	BULLONE	ARBRE
16	REC90501-12M48	90501-12M48	MUELLE	SPRING	MOLLA	RESSORT
17	PAT85-04000004-B	688-45567-01	GRUESO 0.10 mm	SHIM 0.10 mm	SPESSORE 0.10 mm	CALE 0.10 mm
18	REC93317-322V0	93317-322V0	COJINETE	BEARING	CUSCINETTO	PALIER
19	REC90250-07M02	90250-07M02	PASADOR	PIN	SPINOTTO	LEVIER
20	REC688-45633-00	688-45633-00	ANILLO DEL PASADOR	ANNULAR SPRING, CLUTCH	PARAOLIO	RESSORT
21	REC67F-45611-01	67F-45611-01	EJE HÉLICE	PROPELLER SHAFT	ASSE ELICA	ARBRE D'HELICE
22	REC67F-45576-00	67F-45576-00	ARANDELA	WASHER	RONDELLA	RONDELLE
23	REC93306-207U0	93306-207U0	COJINETE	BEARING	CUSCINETTO	PALIER
24	REC93210-86M39	93210-86M39	TÓRICA	O-RING	O-RING	JOINT TORIQUE
25	REC90282-04010	90282-04010	CHAVETA RECTA	KEY	CHIAVETTA	CLAVETTE
26	REC93317-325U0	93317-325U0	COJINETE	BEARING	CUSCINETTO	PALIER
27	REC93101-25M03	93101-25M03	RETÉN DE ACEITE	OIL SEAL	PARAOLIO	JOINT SPI
28	REC688-45383-01	688-45383-02	ARANDELA	WASHER	RONDELLA	RONDELLE
29	REC688-45384-00	688-45384-02	TUERCA	NUT	DADO	ÉCROU
30	REC688-45987-00	688-45987-01	ESPACIADOR	SPACER	DISTANZIALE	ENTRETOISE
31	REC67F-45997-00	67F-45997-00	ESPACIADOR	SPACER	DISTANZIALE	ENTRETOISE
32	REC90389-25M00	90389-25M00	CASQUILLO HÉLICE	WASHER	GHIERA ELICA	RONDELLE D'HELICE
33	REC90171-16011	90171-16011	TUERCA	LOCK NUT	DADO	ÉCROU
34	REC91490-30025	91490-30025	PASADOR	PIN	SPINOTTO	CLAVETTE

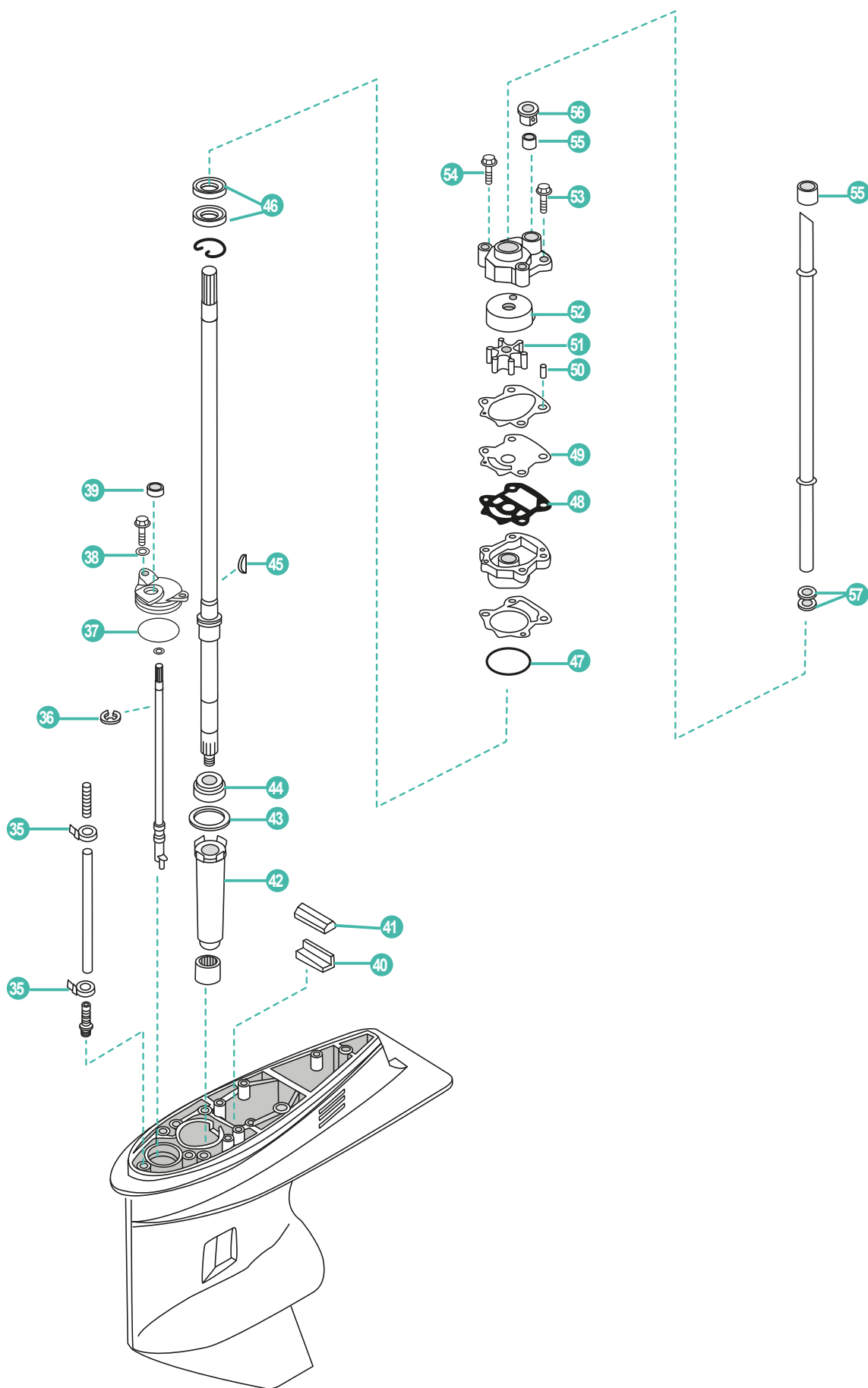

	REF	OEM				
35	PAHT-2.5X60	90465-11M10	BRIDA	CLAMP	FLANGIA	COLLIER
36	REC99001-08600-00	99001-08600	ARANDELA	WASHER	RONDELLA	RONDELLE
37	REC93210-49046	93210-49046	TÓRICA	O-RING	O-RING	JOINT TORIQUE
38	PAGB/T97.1-6	92995-06600	ARANDELA	WASHER	RONDELLA	RONDELLE
39	REC93106-09014	93106-09014	RETÉN DE ACEITE	OIL SEAL	PARAOLIO	JOINT SPI
40	REC663-45376-00	663-45376-00-94	GUÍA SELLO DE GOMA	GUIDE RUB. SEAL	GUIDA PARAOLIO	GUIDE
41	REC688-45375-00	63D-45375-00	RETEN DAMPER	DAMPER WASHER	PARAOLIO DAMPER	JOINT SILENT BLOC
42	REC688-45536-01	688-45536-01	CAMISA EJE	SLEEVE, DRIVE	TUBO GUIDA	RONDELLE
43	PAT85-040000003-B	688-45587-01	GRUESO 0.10 mm	SHIM 0.10 mm	SPESSORE 0.10 mm	CALE 0.10 mm
44	REC93332-000U3	93332-000U3	COJINETE	BEARING	CUSCINETTO	ROULEMENT
45	REC90280-03M03	90280-03M03	CUÑA	KEY WOODRUFF	CHIAVETTA	CLAVETTE
46	REC93101-23070	93101-23070	RETÉN DE ACEITE	OIL SEAL	PARAOLIO	JOINT SPI
47	REC93210-46044	93210-46044	TÓRICA	O-RING	O-RING	JOINT TORIQUE
48	REC6CJ-44324-00	6CJ-44324-00	JUNTA	GASKET	GUARNIZIONE	JOINT
49	REC6CJ-44323-00	6CJ-44323-00	PLACA EXTERIOR	OUTER PLATE, CARTRIDGE	COPERCHIO POMPA D'ACQUA	PLAQUE DE POMPE À EAU
50	PAF15-00000013	93604-10M03	PASADOR	PIN	SPINOTTO	PIN
51	REC6H3-44352-00	6H3-44352-00	TURBINA	IMPELLER	GIRANTE	TURBINE
52	REC63D-44322-00	63D-44322-00	TAPA, BOMBA AGUA	COVER, INNER WATER PUMP	COPERCHIO, POMPA ACQUA	INSERT DE POMPE À EAU
53	REC90119-08M14	90119-08M14	TORNILLO CON ARANDELA	SCREW WITH WASHER	VITE CON RONDELLA	VIS AVEC RONDELLE
54	REC90119-08M33	90119-08M33	TORNILLO CON ARANDELA	SCREW WITH WASHER	VITE CON RONDELLA	VIS AVEC RONDELLE
55	REC663-44366-00	663-44366-00	GOMA DEL SELLO DE AGUA	DAMPER, WATER SEAL	GHIERA	JOINT DE TUBE D'EAU
56	REC63D-44312-00	63D-44312-00	CUBIERTA CAJA DE BOMBA DE AGUA	PUMP COVER	COPERCHIO CORPO ACQUA	PLAQUE POMPE À EAU
57	PAT40-02000002	663-44367-00	GOMA DEL SELLO DE AGUA	GUIDE BUSHING, WATER PIPE	PARAOLIO	JOINT CAOUTCHOUC



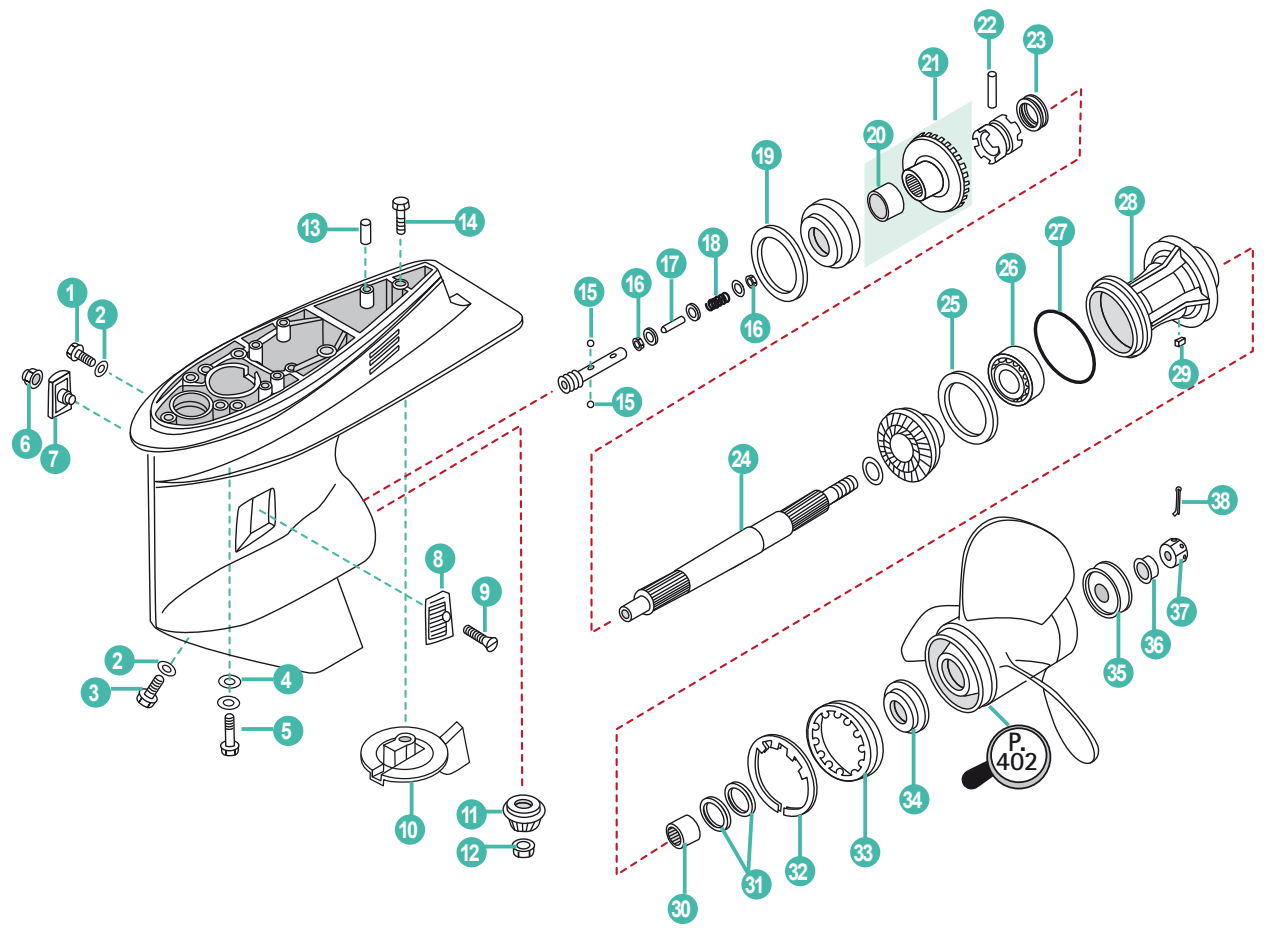

REF	OEM
REC67F-W0001-20	67F-W0001-20

P. 145

REF	OEM
REC67F-W0078-00	67F-W0078-00

P. 152

REF
REC80W90U3
REC80W90U6
RECGREU1
RECGREU12

P. 43

	REF	OEM				
1	REC90340-08002	90340-08002	TORNILLO DRENAJE	BOLT, DISCHARGING OIL	VITE DRENAGGIO	BOUCHON DE VIDANGE
2	REC90430-08020	90430-08003	JUNTA	GASKET	GUARNIZIONE	JOINT
3	REC688-45341-00	688-45341-10	TORNILLO DRENAJE	BOLT, DISCHARGING OIL	VITE DRENAGGIO	BOUCHON DE VIDANGE
4	PAGB/T97.1-8	92995-10600	ARANDELA	WASHER	RONDELLA	RONDELLE
5	REC97075-10040	97075-10040	PERNO	STUD	BULLONE	BOULON
6	PAGB/T6182-M5	90185-05002	TUERCA	LOCK NUT	DADO	ÉCROU
7	REC6H1-45215-00	6H1-45215-00	CUBIERTA ENTRADA AGUA B	WATER INLET B	COPERCHIO ACQUA B	GRILLE D'ENTREE D'EAU B
8	REC6H1-45214-00	6H1-45214-00	CUBIERTA ENTRADA AGUA A	WATER INLET A	COPERCHIO ACQUA A	GRILLE D'ENTREE D'EAU A
9	REC90151-05M00	90152-05000	TORNILLO	SCREW	VITE	VIS
10	CM67F-45371-00A	67F-45371-00	ÁNODO	ANODE	ANODO	ANODE
11	REC6D9-45551-00	6D9-45551-00	PIÑÓN ATAQUE	INITIATIVE GEAR	MARCIA INIZIATIVA	PIGNON D'ATTAQUE
12	REC90170-16M01	90170-16M01	TUERCA	LOCK NUT	DADO	ÉCROU
13	REC93606-12019	93606-12019	PASADOR	PIN	SPINOTTO	PIN
14	PAT85-00000012	90105-16M67	PERNO	STUD	BULLONE	BOULON
15	REC93503-16003	93503-16003	ESFERA	BALL	SFERA	BILLE
16	REC90183-02M03	90183-02M03	TUERCA	LOCK NUT	DADO	ÉCROU
17	REC6H1-45668-00	6H1-45668-00	EJE DEL ÉMBOLO	FREE SHAFT	BULLONE	ARBRE
18	REC90501-12M48	90501-12M48	MUELLE	SPRING	MOLLA	RESSORT
19	PAT85-040000004-B	688-45567-01	GRUESO 0.10 mm	SHIM 0.10 mm	SPESSORE 0.10 mm	CALE 0.10 mm
20	REC93317-322V0	93317-322V0	COJINETE	BEARING	CUSCINETTO	ROULEMENT
21	REC67F-45560-00	67F-45560-00	PIÑÓN MARCHA AVANTE	POSITIVE GEAR ASSY	PIGNONE MARCIA AVANTI	PIGNON DE MARCHE AVANT
22	REC90250-07M02	90250-07M02	PASADOR	PIN	SPINOTTO	PIN
23	REC688-45633-00	688-45633-00	ANILLO DEL PASADOR	ANNULAR SPRING, CLUTCH	PARAOLIO	RESSORT
24	REC67F-45611-01	67F-45611-01	EJE HÉLICE	PROPELLER SHAFT	ASSE ELICA	ARBRE D'HELICE
25	REC67F-45576-00	67F-45576-00	ARANDELA	WASHER	RONDELLA	RONDELLE
26	REC93306-207U0	93306-207U0	COJINETE	BEARING	CUSCINETTO	ROULEMENT
27	REC93210-86M39	93210-86M39	TÓRICA	O-RING	O-RING	JOINT TORIQUE
28	REC67F-45331-00-CA	67F-45331-00-94	DIÁBOLO	BEARING	DIABOLO	DIABOLO
29	REC90282-04010	90282-04010	CHAVETA RECTA	KEY	CHIAVETTA	CHAVETTE
30	REC93317-325U0	93317-325U0	COJINETE	BEARING	CUSCINETTO	PALIER
31	REC93101-25M03	93101-25M03	RETÉN DE ACEITE	OIL SEAL	PARAOLIO	JOINT SPI
32	REC688-45383-01	688-45383-02	ARANDELA	WASHER	RONDELLA	RONDELLE
33	REC688-45384-00	688-45384-02	TUERCA	NUT	DADO	ÉCROU
34	REC688-45987-00	688-45987-01	ESPACIADOR	SPACER	DISTANZIALE	ENTRETOISE
35	REC67F-45997-00	67F-45997-00	ESPACIADOR	SPACER	DISTANZIALE	ENTRETOISE
36	REC90389-25M00	90389-25M00	CASQUILLO HÉLICE	WASHER	GHIERA ELICA	RONDELLE D'HELICE
37	REC90171-16011	90171-16011	TUERCA	LOCK NUT	DADO	ÉCROU
38	REC91490-40030	91490-40025	PASADOR	PIN	SPINOTTO	CLAVETTE

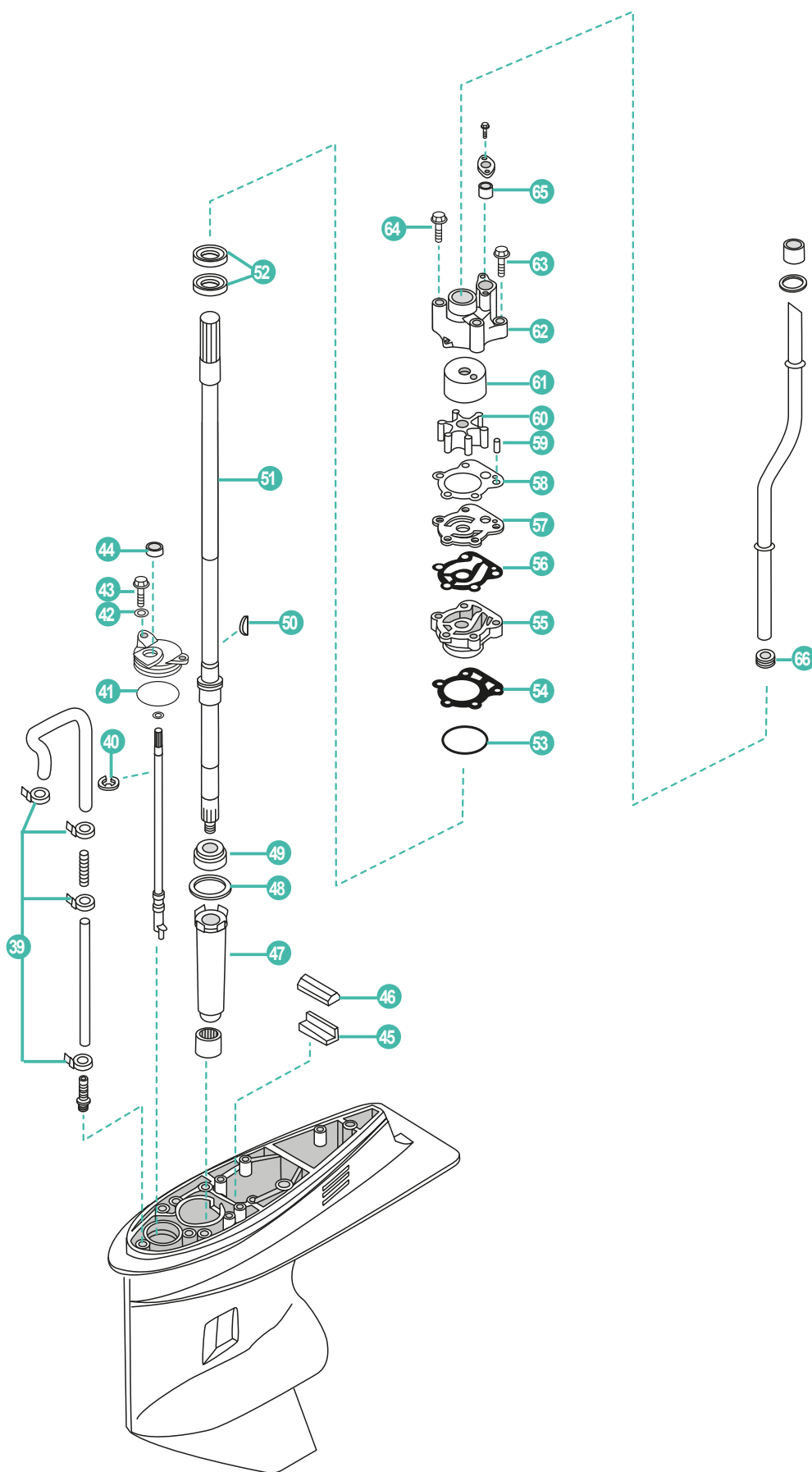

	REF	OEM				
39	PAHT-2.5X60	90465-11M10	BRIDA	CLAMP	FLANGIA	COLLIER
40	REC99001-08600-00	99001-08600	ARANDELA	WASHER	RONDELLA	RONDELLE
41	REC93210-49046	93210-49046	TÓRICA	O-RING	O-RING	JOINT TORIQUE
42	PAGB/T97.1-6	92995-06600	ARANDELA	WASHER	RONDELLA	RONDELLE
43	PAGB/T5783-M6X16	97095-06016	PERNO HEXAGONAL	HEXAGON BOLT	BULLONE ESSAGONALE	BOULON HEXAGONAL
44	REC93106-09014	93106-09014	RETÉN DE ACEITE	OIL SEAL	PARAOLIO	JOINT SPI
45	REC663-45376-00	663-45376-00-94	GUÍA SELLO DE GOMA	GUIDE RUB. SEAL	GUIDA PARAOLIO	GUIDE
46	REC688-45375-00	63D-45375-00	RETEN DAMPER	DAMPER WASHER	PARAOLIO DAMPER	JOINT SILENT BLOC
47	REC688-45536-01	688-45536-01	CAMISA EJE	SLEEVE, DRIVE	TUBO GUIDA	RONDELLE
48	PAT85-040000003-B	688-45587-01	GRUESO 0.10 mm	SHIM 0.10 mm	SPESSORE 0.10 mm	CALE 0.10 mm
49	REC93332-000U3	93332-000U3	COJINETE	BEARING	CUSCINETTO	ROULEMENT
50	REC90280-04M04	90280-04M04	CUÑA	KEY WOODRUFF	CHIAVETTA	CLAVETTE
51	REC67F-45501-10	67F-45501-10	EJE VERTICAL L (21,1")	DRIVE SHAFT L (21,1")	ALBERO TRANSON L (21,1")	ARBRE VERTICAL L (21,1")
52	REC93101-25M03	93101-25M03	RETÉN DE ACEITE	OIL SEAL	PARAOLIO	JOINT SPI
53	REC93210-46044	93210-46044	TÓRICA	O-RING	O-RING	JOINT TORIQUE
54	REC688-44316-00	688-44316-00	JUNTA	GASKET	GUARNIZIONE	JOINT
55	REC688-44341-01	6D8-44341-01	CUERPO RETENES BOMBA DE AGUA	HOUSING WATER PUMP	CORPO POMPA	BASE DE POMPE À EAU
56	REC688-44324-00	688-44324-A0	JUNTA	GASKET	GUARNIZIONE	JOINT
57	REC67F-44323-00	67F-44323-00	PLACA EXTERIOR	WEAR PLATE	COPERCHIO	PLAQUE DE POMPE À EAU
58	REC688-44315-00	688-44315-A0	JUNTA	GASKET	GUARNIZIONE	JOINT
59	PAF25-04000007	93604-10M03	PASADOR	PIN	SPINOTTO	LEVIER
60	REC67F-44352-00	67F-44352-00	TURBINA	IMPELLER	GIRANTE	TURBINE
61	REC67F-44322-00	67F-44322-00	TAPA, BOMBA AGUA	COVER, INNER WATER PUMP	COPERCHIO, POMPE ACQUA	INSERT DE POMPE À EAU
62	REC67F-44311-01	67F-44311-00	CUERPO BOMBA AGUA	HOUSING, WATER PUMP	CORPO POMPA	CORPS DE POMPE À EAU
63	REC90119-08M13	90119-08M13	TORNILLO CON ARANDELA	SCREW WITH WASHER	VITE CON RONDELLA	VIS AVEC RONDELLE
64	REC90119-08M87	90119-08M87	TORNILLO CON ARANDELA	SCREW WITH WASHER	VITE CON RONDELLA	VIS AVEC RONDELLE
65	REC663-44366-00	663-44366-00	RETEN TUBO AGUA	DAMPER, WATER SEAL	GHIERA	JOINT DE TUBE D'EAU
66	PAT40-02000002	663-44367-00	GOMA DEL SELLO DE AGUA	GUIDE BUSHING, WATER PIPE	PARAOLIO	MAUCHON CAOUTCHOUC DE PIPE D'EAU



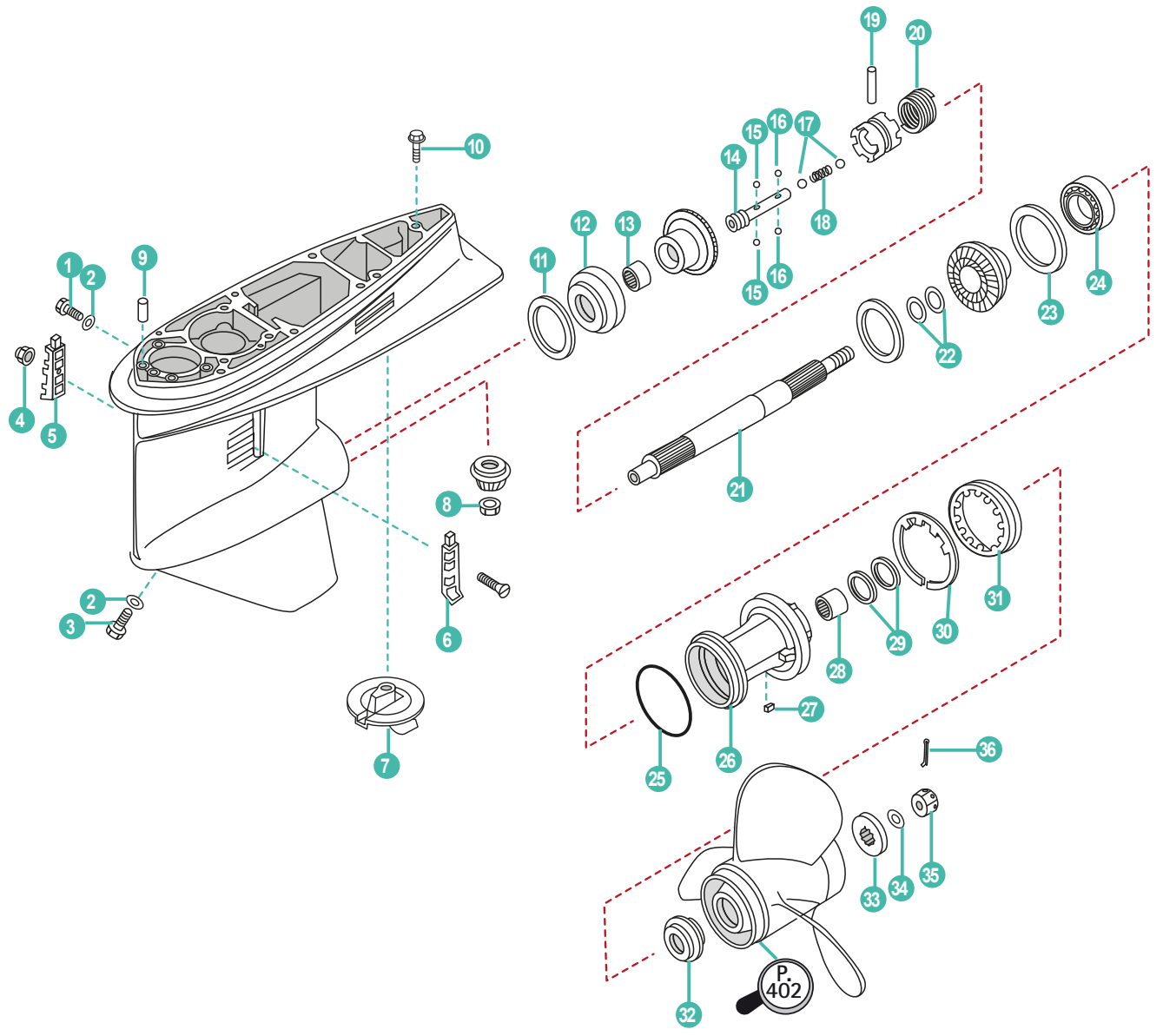

REF	OEM
REC68V-W0001-20	68V-W0001-20

P. 147

REF	OEM
REC68V-W0078-00	68V-W0078-00

P. 152

REF
REC80W90U3
REC80W90U6
RECGREU1
RECGREU12

P. 43

	REF	OEM				
1	REC90340-08002	90340-08002	TORNILLO DRENAJE	BOLT, DISCHARGING OIL	VITE DRENAGGIO	BOUCHON DE VIDANGE
2	REC90430-08020	90430-08003	JUNTA	GASKET	GUARNIZIONE	JOINT
3	REC688-45341-00	688-45341-10	TORNILLO DRENAJE	BOLT, DISCHARGING OIL	VITE DRENAGGIO	BOUCHON DE VIDANGE
4	PAGB/T6182-M5	90185-05002	TUERCA	LOCK NUT	DADO	ÉCROU
5	REC688-45215-02	688-45215-02	CUBIERTA ENTRADA AGUA B	WATER INLET B	COPERCHIO ACQUA B	GRILLE D'ENTREE D'EAU B
6	REC688-45214-02	688-45214-02	CUBIERTA ENTRADA AGUA A	WATER INLET A	COPERCHIO ACQUA A	GRILLE D'ENTREE D'EAU A
7	CM6E5-45371-01A	6E5-45371-00	ÁNODO	ANODE	ANODO	ANODE
8	REC90170-16M01	90170-16M01	TUERCA	LOCK NUT	DADO	ÉCROU
9	REC93608-12M05	93608-12M05	PASADOR	PIN	SPINOTTO	PIN
10	PAT85-00000012	90105-10M00	TORNILLO	SCREW	VITE	VIS
11	REC6E5-45567-01	6E5-45567-01	KIT GRUESOS 0.12 - 0.50 mm	SHIM SET 0.12 - 0.50 mm	KIT SPESSORI 0.12 - 0.50 mm	KIT CALES 0.12 - 0.50 mm
12	REC93332-000U7	93332-000U7	COJINETE	BEARING	CUSCINETTO	ROULEMENT
13	REC93315-425U7	93315-425U7	COJINETE	BEARING	CUSCINETTO	ROULEMENT
14	REC6E5-45634-01	6E5-45634-01	PASADOR DESPLAZABLE	SLIDE SHIFT	SPINOTTO SCORREVOLE	PIN REGLABLE
15	REC93507-32031	93507-32009	ESFERA	BALL	SFERA	BILLE
16	REC93503-16003	93503-16003	ESFERA	BALL	SFERA	BILLE
17	REC93511-32027	93511-32027	ESFERA	BALL	SFERA	BILLE
18	REC90501-16M37	90501-16M37	MUELLE	SPRING	MOLLA	RESSORT
19	REC90250-08M07	90250-08M07	PASADOR	PIN	SPINOTTO	LEVIER
20	REC6E5-45633-01	6E5-45633-01	ANILLO DEL PASADOR	ANNULAR SPRING, CLUTCH	ANELLO SELETTORE	RESSORT
21	REC6E5-45611-00	6E5-45611-00	EJE HÉLICE	PROPELLER SHAFT	ASSE ELICA	ARBRE D'HELICE
22	REC90201-30M92	90201-30M92	ARANDELA	WASHER	RONDELLA	RONDELLE
23	REC6E5-45576-00	6E5-45576-00	ARANDELA	WASHER	RONDELLA	RONDELLE
24	REC93306-208U0	93306-208U0	COJINETE	BEARING	CUSCINETTO	ROULEMENT
25	REC93210-86M39	93210-86M39	TÓRICA	O-RING	O-RING	JOINT TORIQUE
26	REC6E5-45332-00-94	6E5-45332-00-CA	DIÁBOLO	GEAR HOUSING	DIABOLO	DIABOLO
27	REC90282-04010	90282-04010	CHAVETA RECTA	KEY	CHIAVETTA	CHAVETTE
28	REC93315-430U8	93315-430U8	COJINETE	BEARING	CUSCINETTO	ROULEMENT
29	REC93101-30M17	93101-30M17	RETÉN DE ACEITE	OIL SEAL	PARAOLIO	JOINT SPI
30	REC688-45383-01	688-45383-02	ARANDELA	WASHER	RONDELLA	RONDELLE
31	REC688-45384-00	688-45384-02	TUERCA	NUT	DADO	ÉCROU
32	REC6E5-45987-00	63P-45987-00	ESPACIADOR	SPACER	DISTANZIALE	ENTRETOISE
33	REC688-45997-00	688-45997-01	ESPACIADOR	SPACER	DISTANZIALE	ENTRETOISE
34	REC92990-18200	92990-18200	ARANDELA	WASHER	RONDELLA	RONDELLE
35	REC90171-18M04	90171-18M04	TUERCA	LOCK NUT	DADO	ÉCROU
36	REC91490-40030	91490-40030	PASADOR	PIN	SPINOTTO	CLAVETTE

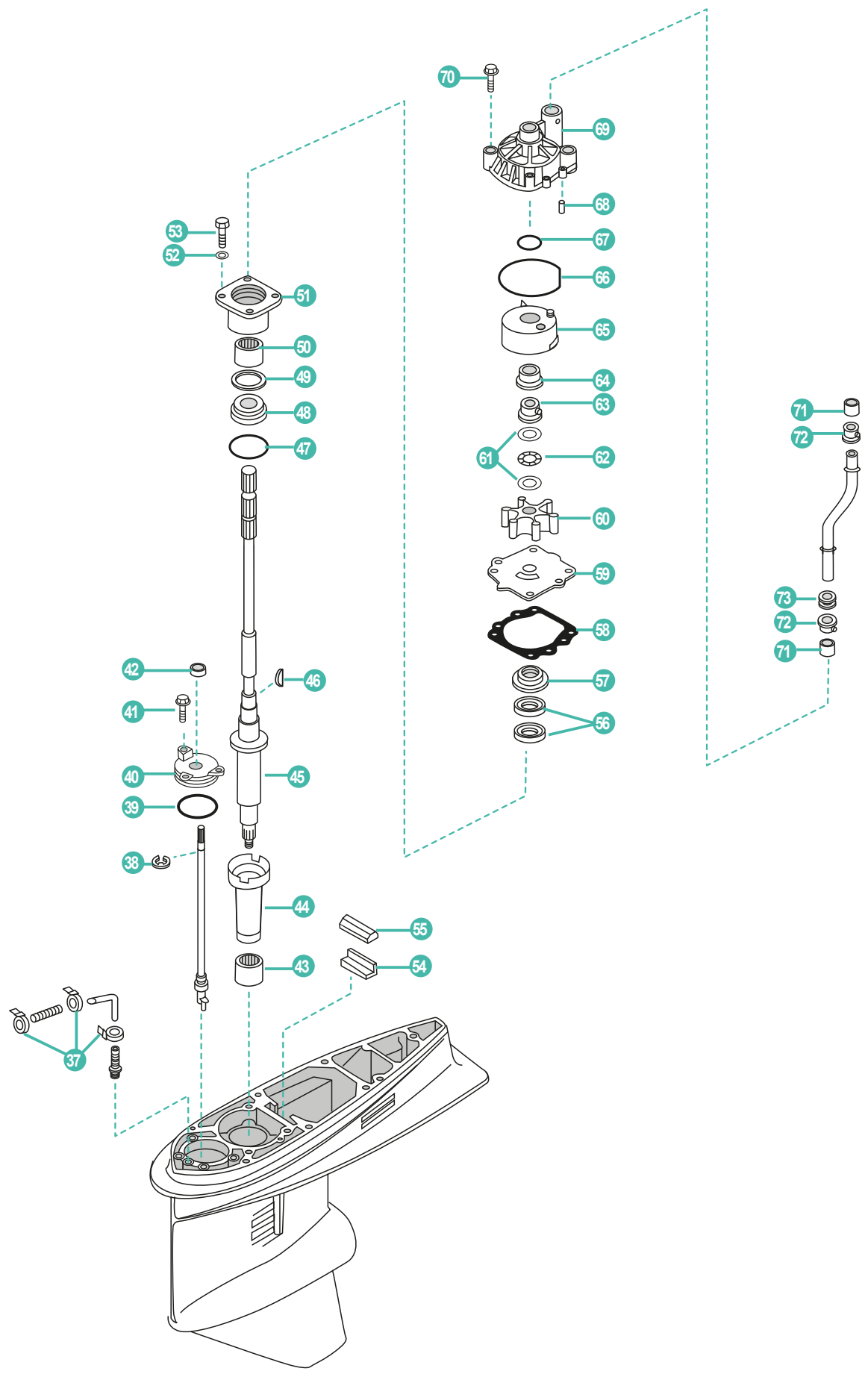

	REF	OEM				
37	PAHT-2.5X60	90465-11M10	BRIDA	CLAMP	FLANGIA	COLLIER
38	REC99001-08600-00	99001-08600	ARANDELA	WASHER	RONDELLA	RONDELLE
39	REC93210-58677	93210-58144	TÓRICA	O-RING	O-RING	JOINT TORIQUE
40	REC6E5-45321-00	6E5-45321-00	TAPA CAMBIO	PLATE	COPERCHIO CAMBIO	COUVERCLE
41	REC90119-06M10	90119-06M10	TORNILLO CON ARANDELA	SCREW WITH WASHER	VITE CON RONDELLA	VIS AVEC RONDELLE
42	REC93106-09014	93106-09014	RETÉN DE ACEITE	OIL SEAL	PARAOLIO	JOINT SPI
43	REC93315-628U9	93315-628U9	COJINETE	BEARING	CUSCINETTO	ROULEMENT
44	REC6E5-45536-00	6E5-45536-00	CAMISA EJE DE MANDO	SLEEVE	CAMICIA	BAGUE
45	REC68V-45501-10	68V-45501-10	EJE TRANSMISION L 20.3"	DRIVE SHAFT L 20.3"	ASSE TRASMISSIONE L 20,3"	ARBRE DE TRANSMISSION L 20,3"
46	REC90280-04M05	90280-04M05	CUÑA	KEY WOODRUFF	CHIAVETTA	CLAVETTE
47	REC93210-54534	93210-55M14	TÓRICA	O-RING	O-RING	JOINT TORIQUE
48	REC93341-930V2	93341-930V2	COJINETE	BEARING	CUSCINETTO	ROULEMENT
49	REC6E5-45587-01	6E5-45587-01	KIT GRUESOS 0.12 - 0.50 mm	SHIM SET 0.12 - 0.50 mm	KIT SPESSORI 0.12 - 0.50 mm	KIT CALES 0.12 - 50 mm
50	REC93317-330U2	93317-330U2	COJINETE	BEARING	CUSCINETTO	ROULEMENT
51	REC6E5-45331-00-94	6E5-45331-00-9S	DIÁBOLO	GEAR HOUSING	DIABOLO	DIABOLO
52	PAGB/T97.1-8	92995-08600	ARANDELA	WASHER	RONDELLA	RONDELLE
53	PAGB/T5783-M8X25	97095-08025	PERNO	BOLT	VOTE	BOULON
54	REC663-45376-00	663-45376-00	GUÍA SELLO DE GOMA	GUIDE RUB. SEAL	GUIDA PARAOLIO	GUIDE
55	REC688-45375-00	63D-45375-00	RETEN DAMPER	DAMPER WASHER	PARAOLIO DAMPER	JOINT SILENT BLOC
56	REC93101-28M16	93101-28M16	RETÉN DE ACEITE	OIL SEAL	PARAOLIO	JOINT SPI
57	REC6E5-45344-00	6E5-45344-00	TAPA RETEN	RETAINER	COPERCHIO PARAOLIO	RETENUE
58	REC6E5-44315-A0	6E5-44315-A0	JUNTA	GASKET	GUARNIZIONE	JOINT
59	REC68V-44323-00	6EK-44323-00	TAPA BOMBA	OUTER PLATE	COPERCHIO POMPA	PLAQUE DE POMPE À EAU
60	REC6E5-44352-01	6E5-44352-01	TURBINA	IMPELLER	GIRANTE	TURBINE
61	REC90201-22M01	90201-22M01	ARANDELA	WASHER	RONDELLA	RONDELLE
62	REC90206-22M19	90206-22M19	ARANDELA ONDULADA	WAVE WASHER	RONDELLA ONDULATA	RONDELLE
63	REC61A-45538-00	61A-45538-00	ESPACIADOR	SPACER	SPESSORE	ENTRETOISE
64	REC61A-45527-00	61A-45527-00	CASQUILLO CUERPO BOMBA	COLLAR	BOCCOLA CORPO POMPA	BAGUE POMPE À EAU
65	REC61A-44322-02	61A-44322-02	TAPA, BOMBA AGUA	COVER, INNER WATER PUMP	COPERCHIO, POMPE D'EAU	INSERT DE POMPE À EAU
66	REC93210-86M38	93210-86M38	TÓRICA	O-RING	O-RING	JOINT TORIQUE
67	REC93210-37160	93210-37160	TÓRICA	O-RING	O-RING	JOINT TORIQUE
68	REC93606-12019	93606-12019	PASADOR	PIN	SPINOTTO	LEVIER
69	REC61A-44311-00	61A-44311-01	CUERPO BOMBA AGUA	HOUSING, WATER PUMP	CORPO POMPA	CORPS DE POMPE À EAU
70	REC90119-08M14	90119-08M14	TORNILLO CON ARANDELA	SCREW WITH WASHER	VITE CON RONDELLA	VIS AVEC RONDELLE
71	REC6E5-44365-00	6E5-44365-00	GOMA DEL SELLO DE AGUA	DAMPER WATER TUBE	GUARNIZIONE	BAGUE DE TUBE D'EAU
72	REC6E5-44312-00	6E5-44312-00	CUBIERTA CAJA DE BOMBA DE AGUA	PUMP COVER	COPERCHIO CORPO ACQUA	PLAQUE POMPE À EAU
73	REC6E5-44366-00	6E5-44366-00	FLECTOR	DAMPER WATER SEAL	GUARNIZIONE	JOINT





REF	OEM				
REC416-B20F	63P-45300-02-8D	CONJUNTO INFERIOR RR (L) SÓLO PARA F150	COMPLETE GEARCASE V6 (L) ONLY F150	PIEDE COMPLETO (L) SOLO F150	EMBASE COMPLETE (L) POUR F150
REC416-B25F	63P-45300-12-8D	CONJUNTO INFERIOR RR (X) SÓLO PARA F150	COMPLETE GEARCASE V6 (X) ONLY F150	PIEDE COMPLETO V6 (X) SOLO F150	EMBASE COMPLETE V6 (X) POUR F150
REC418-B25F	64P-45300-12-8D	CONJUNTO INFERIOR CR (X) SÓLO PARA F150	COMPLETE GEARCASE V6 CR (X) ONLY F150	PIEDE COMPLETE CR (X) FOLO F150	EMBASE COMPLETE CONTRE ROTATION (X) POUR F150
1 REC90340-08002	90304-08002	TORNILLO DRENAJE	BOLT, DISCHARGING OIL	VITE DRENAGGIO	BOUCHON DE VIDANGE
2 REC90430-08020	90430-08020	JUNTA	GASKET	GUARNIZIONE	JOINT
3 REC688-45341-00	688-45341-10	TORNILLO DRENAJE	BOLT, DISCHARGING OIL	VITE DRENAGGIO	BOUCHON DE VIDANGE
4 PAGB/T6182-M5	90185-05002	TUERCA	LOCK NUT	DADO	ÉCROU
5 REC63P-45551-00	63P-45551-00	PIÑÓN ATAQUE	INITIATIVE GEAR	MARCIA INIZIATIVA	PIGNON D'ATTAQUE
6 REC90170-16M01	90170-16M01	TUERCA	LOCK NUT	DADO	ÉCROU
7 CM6J9-45371-01A	6J9-45371-01	ÁNODO	ANODE	ANODO	ANODE
8 PAT85-00000012	90105-10M00	TORNILLO	SCREW	VITE	VIS
9 REC93332-000V3	93332-000V3	COJINETE	BEARING	CUSCINETTO	ROULEMENT
10 REC93315-425V3	93315-425V3	COJINETE	BEARING	CUSCINETTO	ROULEMENT
11 REC6E5-45641-03	6E5-45641-03	EJE	SHAFT	ASSE	ARBRE
12 REC6E5-45634-01	6E5-45634-01	PASADOR DESPLAZABLE	SLIDE SHIFT	SPINOTTO SCORREVOLE	PIN REGLABLE
13 REC93507-32031	93507-32009	ESFERA	BALL	SFERA	BILLE
14 REC93503-16003	93503-16003	ESFERA	BALL	SFERA	BILLE
15 REC93511-32027	93511-32017	ESFERA	BALL	SFERA	BILLE
16 REC90501-16M37	90501-16M37	MUELLE	SPRING	MOLLA	RESSORT
17 REC90250-08M07	90250-08M07	PASADOR	PIN	SPINOTTO	PIN
18 REC6E5-45633-01	6E5-45633-01	ANILLO DEL PASADOR	ANNULAR SPRING, CLUTCH	ANELLO	RESSORT
19 REC6J9-45611-00	6J9-45611-01	EJE HÉLICE	PROPELLER SHAFT	ASSE ELICA	ARBRE D'HELICE
20 REC90201-30M92	90201-30M92	ARANDELA	WASHER	RONDELLA	RONDELLE
21 REC6G5-45576-10	6G5-45576-10	ARANDELA EMPUJE	WASHER, THRUST	RONDELLA DI SPINTA	RONDELLE D'APPUI
22 REC93306-209U0	93306-209U0	COJINETE	BEARING	CUSCINETTO	ROULEMENT
23 REC93210-97M55	93210-97M55	TÓRICA	O-RING	O-RING	JOINT TORIQUE
24 REC6J9-45332-00-CA	6J9-45332-00-CA	DIÁBOLO	GEAR HOUSING	DIABOLO	DIABOLO
25 REC90282-04M00	90282-04M00	CHAVETA RECTA	KEY	CHIAVETTA	CLAVETTE
26 REC93315-43061	93315-43061	COJINETE	BEARING	CUSCINETTO	ROULEMENT
27 REC93101-30M17	93101-30M17	RETÉN DE ACEITE	OIL SEAL	PARAOLIO	JOINT SPI
28 REC6G5-45383-01	6G5-45383-01	ARANDELA	WASHER	RONDELLA	RONDELLE
29 REC6G5-45384-00	6G5-45384-00	TUERCA	NUT	DADO	ÉCROU
30 REC6E5-45987-00	63P-45987-00	ESPACIADOR	SPACER	DISTANZIALE	ENTRETOISE
31 REC688-45997-00	688-45997-01	ESPACIADOR	SPACER	DISTANZIALE	ENTRETOISE
32 REC92990-18200	92990-18200	ARANDELA	WASHER	RONDELLA	RONDELLE
33 REC90171-18M04	90171-18M04	TUERCA	LOCK NUT	DADO	ÉCROU
34 REC91490-40030	91490-40030	PASADOR	PIN	SPINOTTO	CLAVETTE
		<b>CONTRA ROTACIÓN</b>	<b>COUNTER ROTATION</b>	<b>CONTRO ROTANTE</b>	<b>CONTRE</b>
35 REC6E5-45634-01	6E5-45634-02	DESLIZADOR CAMBIO	SLIDE SHIFT	SPINOTTO SCORREVOLE	PIN REGLABLE
36 REC93332-00048	93332-00048	COJINETE	BEARING	CUSCINETTO	ROULEMENT

4T F150A/T/B/D (FL) • F175A/C • F200F/G  
STROKES

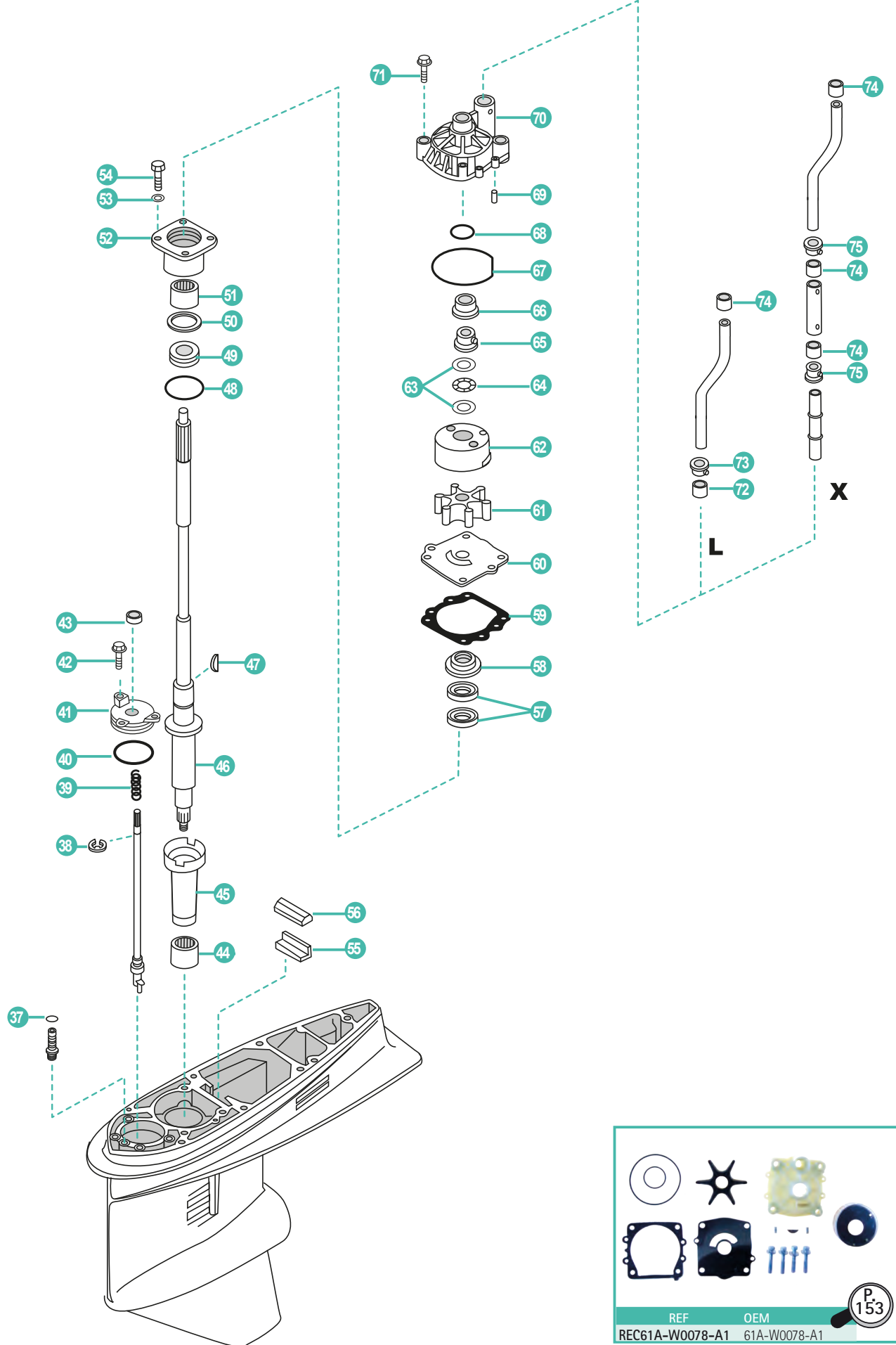

REF	OEM
REC61A-W0078-A1	61A-W0078-A1

P. 153

	REF	OEM				
37	REC93210-07540	93210-07003	TÓRICA	O-RING	O-RING	JOINT TORIQUE
38	REC99001-08600-00	99001-08600	CLIP	CLIP	CLIP	CLIP
39	REC90501-11M10-00	90501-11M10	RESORTE DE COMPRESIÓN	SPRING	MOLLA	RESSORT
40	REC93210-58677	93210-58144	TÓRICA	O-RING	O-RING	JOINT TORQUE
41	REC6E5-45321-00	6E5-45321-00	TAPA CAMBIO	PLATE	COPERCHIO CAMBIO	COUVERCLE
42	REC90119-06M10	90119-06M10	TORNILLO CON ARANDELA	SCREW WITH WASHER	VITE CON RONDELLA	VIS AVEC RONDELLE
43	REC93106-09014	93106-09014	RETÉN DE ACEITE	OIL SEAL	PARAOILIO	JOINT SPI
44	REC93311-928U5	93311-928U5	COJINETE	BEARING	CUSCINETTO	ROULEMENT
45	REC6E5-45536-00	6E5-45536-01	CAMISA EJE DE MANDO	SLEEVE	CAMICIA	BAGUE
46	REC63P-45501-00	63P-45501-00	EJE TRASMISION 20" (L)	DRIVE SHAFT 20" (L)	ALBERO DI TRASMISSIONE 20" (L)	ARBRE TRASMISION 20" (L)
	REC63P-45501-10	63P-45501-10	EJE TRASMISION 25" (X)	DRIVE SHAFT 25" (X)	ALBERO DI TRASMISSIONE 25" (X)	ARBRE TRASMISION 25" (X)
47	REC90280-04M05	90280-04M05	CUÑA	KEY WOODRUFF	CHIAVETTA	CLAVETTE
48	REC93210-54534	93210-55M14	TÓRICA	O-RING	O-RING	JOINT TORIQUE
49	REC93341-930V2	93341-930V2	COJINETE	BEARING	CUSCINETTO	ROULEMENT
50	REC6E5-45587-01	6E5-45587-01	KIT GRUESOS 0.10 - 0.50 mm	SHIM SET 0.10 - 0.50 mm	KIT SPESSORI 0.10 - 0.50 mm	KIT CALES 0.10- 0.50 mm
51	REC93317-330U2	93317-330U2	COJINETE	BEARING	CUSCINETTO	ROULEMENT
52	REC6E5-45331-00-94	6E5-45331-00-95	DIÁBOLO	GEAR HOUSING	DIABOLO	DIABOLO
53	PAGB/T97.1-8	92995-08600	ARANDELA	WASHER	RONDELLA	RONDELLE
54	PAGB/T5783-M8X25	97095-08025	PERNO	BOLT	BULLONE	BOULON
55	REC663-45376-00	663-45376-00-94	GUÍA SELLO DE GOMA	GUIDE RUB. SEAL	GUIDA PARAOLIO	GUIDE
56	REC688-45375-00	688-45375-00	RETEN DAMPER	DAMPER WASHER	PARAOILIO DAMPER	JOINT SILENT BLOC
57	REC93101-28M16	93101-28M16	RETÉN DE ACEITE	OIL SEAL	PARAOILIO	JOINT SPI
58	REC6E5-45344-00	6E5-45344-00	CUBIERTA SELLO DE ACEITE	RETAINER	COPERCHIO PARAOLIO	RETENUE
59	REC6E5-44315-A0	6E5-44315-A0	JUNTA	GASKET	GUARNIZIONE	JOINT
60	REC6G5-44323-00	6G5-44323-00	PLACA EXTERIOR DEL CARTUCHO	OUTER PLATE	COPERCHIO POMPA	PLAQUE DE POMPE À EAU
61	REC6E5-44352-01	6E5-44352-01	TURBINA	IMPELLER	GIRANTE	TURBINE
62	REC61A-44322-02	61A-44322-02	ACOPLE INOX	INSERT CARTRIDGE	ACCOPIAMENTO INOX	INSERT DE POMPE À EAU
63	REC90201-22M01	90201-22M01	ARANDELA	WASHER	RONDELLA	RONDELLE
64	REC90206-22M19	90206-22M19	ARANDELA ONDULADA	WAVE WASHER	RONDELLA ONDULATA	RONDELLE
65	REC61A-45538-00	61A-45538-00	ESPACIADOR	SPACER	SPESSORE	ENTRETOISE
66	REC61A-45527-00	61A-45527-00	CASQUILLO CUERPO BOMBA	COLLAR	BOCCOLA CORPO POMPA	BAGUE POMPE À EAU
67	REC93210-86M38	93210-86M38	TÓRICA	O-RING	O-RING	JOINT TORIQUE
68	REC93210-37160	93210-37160	TÓRICA	O-RING	O-RING	JOINT TORIQUE
69	REC93606-12019	93606-12019	PASADOR	PIN	SPINOTTO	PIN
70	REC61A-44311-00	61A-44311-01	CUERPO BOMBA AGUA	HOUSING, WATER PUMP	CORPO POMPA	CORPS DE POMPE À EAU
71	REC90119-08M14	90119-08M14	TORNILLO CON ARANDELA	SCREW WITH WASHER	VITE CON RONDELLA	VIS AVEC RONDELLE
72	REC6E5-44365-00	6E5-44365-00	GOMA DEL SELLO DE AGUA	DAMPER WATER TUBE	GUARNIZIONE	BAGUE DE TUBE D'EAU
73	REC6E5-44312-00	6E5-44312-00	CUBIERTA CAJA DE BOMBA DE AGUA (L)	WATER PUMP COVER (L)	COPERCHIO POMPA ACQUA (L)	GUIDE DE TBE D'EAU (L)
74	REC6E5-44365-00	6E5-44365-00	GOMA TUBO AGUA	DAMPER WATER TUBE	GUARNIZIONE	BAGUE DE TUBE D'EAU
75	REC6E5-44312-00	6E5-44312-00	CUBIERTA CAJA DE BOMBA DE AGUA (X)	WATER PUMP COVER (X)	COPERCHIO POMPA ACQUA (X)	GUIDE DE TUBE D'EAU (X)



REF  
REC80W90U3  
REC80W90U6  
RECGREU1  
RECGREU12



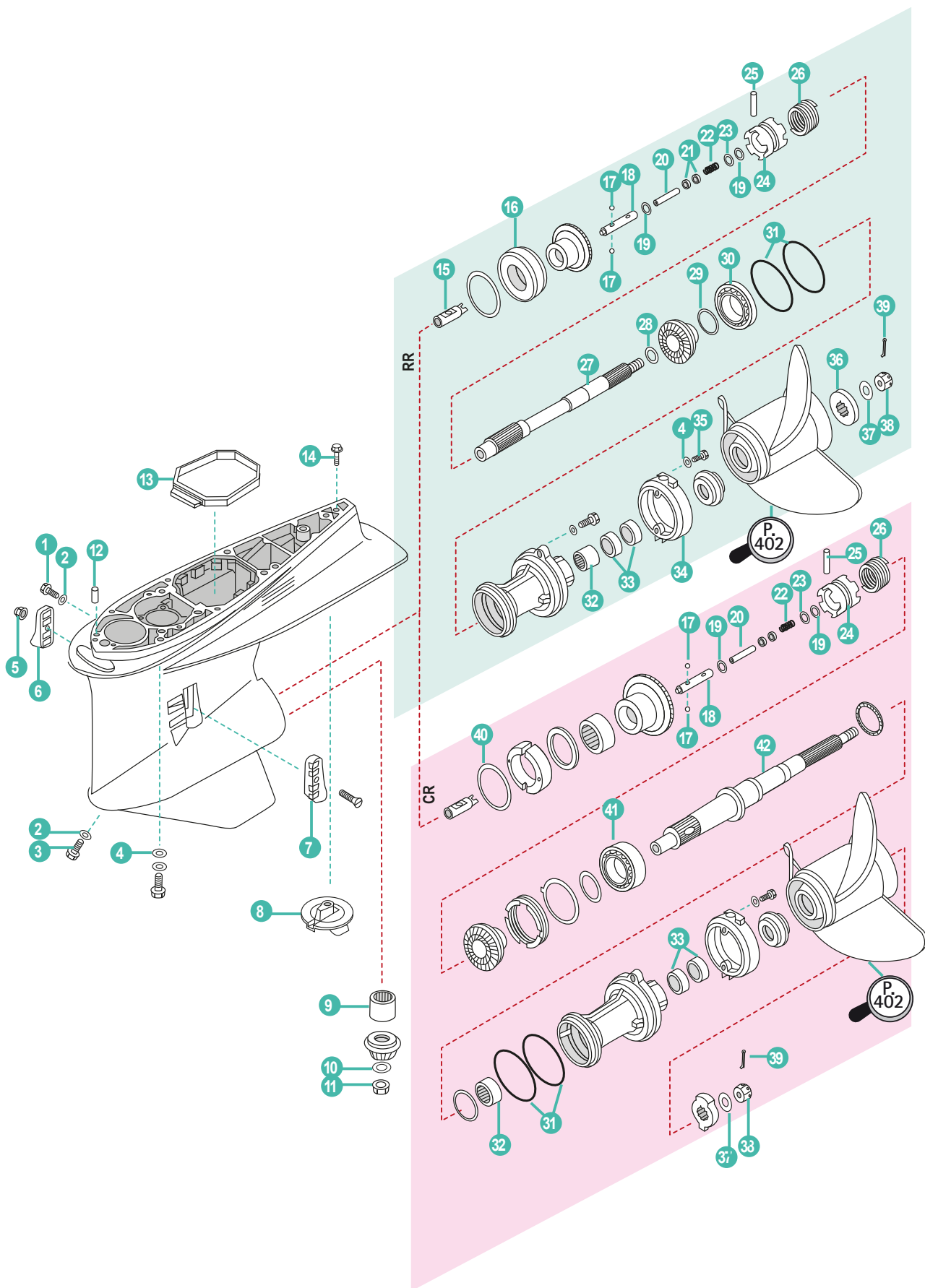

	REF	OEM				
	REC421-B25F	69J-45300-22-8D	CONJUNTO INFERIOR RR (X)	COMPLETE GEARCASE V6 (X)	PIEDE COMPLETO V6 (X)	EMBASE COMPLETE (X)
1	REC90340-08002	90304-08002	TORNILLO DRENAJE	BOLT, DISCHARGING OIL	VITE DRENAGGIO	BOUCHON DE VIDANGE
2	REC90430-08020	90430-08020	JUNTA	GASKET	GUARNIZIONE	JOINT
3	REC688-45341-00	688-45341-10	TORNILLO DRENAJE	BOLT, DISCHARGING OIL	VITE DRENAGGIO	BOUCHON DE VIDANGE
4	PAGB/T97.1-8	92995-10600	ARANDELA	WASHER	RONDELLA	RONDELLE
5	PAGB/T6182-M5	90185-05002	TUERCA	LOCK NUT	DADO	ÉCROU
6	REC61A-45215-10	61A-45215-11	REJILLA TOMA AGUA ESTIBOR	WATER SCREEN STARBOARD	GRIGLIA PRESA ACQUA TRIBORDO	GRILLE D'ENTREE D'EAU TRIBORD
7	REC61A-45214-10	61A-45214-11	REJILLA TOMA AGUA BABOR	WATER SCREEN PORT	GRIGLIA PRESA ACQUA BABORDO	GRILLE D'ENTREE D'EAU BABORD
8	CM61A-45371-00A	61A-45371-00	ÁNODO	ANODE	ANODO	ANODE
9	REC93311-83280	93311-83280	COJINETE	BEARING	CUSCINETTO	ROULEMENT
10	REC90201-16M00	90201-16M00	ARANDELA	WASHER	RONDELLA	RONDELLE
11	REC90170-16M19	90170-16M19	TUERCA	LOCK NUT	DADO	ÉCROU
12	REC93608-12M05	93608-12M05	PASADOR	PIN	SPINOTTO	PIN
13	REC69J-45375-00	69J-45375-00	GOMA ESCAPE COLA	EXHAUST DAMPER	GOMMA SCARICO	JOINT D'ÉCHAPPEMENT
14	PAT85-00000012	90105-10M00	TORNILLO	SCREW	VITE	VIS
15	REC61A-45641-02	61A-45641-02	CAMBIO	SHIFTER	CAMBIO	SHIFTER
16	REC93332-000W1	93332-000W1	COJINETE	BEARING	CUSCINETTO	ROULEMENT
17	REC93501-04011	93501-04011	ESFERA	BALL	SFERA	BILLE
18	REC61A-45634-01	61A-45634-01	PASADOR DESPLAZABLE	SLIDE SHIFT	SPINOTTO SCORREVOLE	PIN REGLABLE
19	REC90183-02M03	90183-02M03	TUERCA DE RESORTE	SPRING NUT	DADO MOLLA	RONDELLE FREIN
20	REC6H1-45668-00	6H1-45668-00	EJE	FREE SHAFT	ASSE	ARBRE
21	REC61A-45635-00	61A-45635-00	ÉMBOLO DE CAMBIO	SHIFT PLUNGER	GOMMINI	SHIFT
22	REC90501-10M77	90501-10M77	RESORTE DE COMPRESIÓN	SPRING	MOLLA	RESSORT
23	REC90201-02M00	90201-02M00	ARANDELA PLANA	WASHER	RONDELLA	RONDELLE
24	REC69J-45631-00	69J-45631-00	EMBRAGUE DE GARRA	CLUTH	SELETTORE	CRABOT
25	REC61A-45632-00	61A-45632-00	PASADOR	PIN	SPINOTTO	LEVIER
26	REC61A-45633-00	61A-45633-00	ANILLO DEL PASADOR	ANNULAR SPRING, CLUTCH	ANELLO	RESSORT
27	REC69J-45611-00	69J-45611-00	EJE	SHAFT	ASSE	ARBRE D'HELICE
28	REC90201-31M00	90201-31M00	ARANDELA PLANA	WASHER	RONDELLA	RONDELLE
29	REC61A-45577-00/60-0	61A-45577-00	KIT GRUESOS (0.10-0.50 mm)	KIT SHIM (0.10-0.50 mm)	KIT SPESSORE (0.10-0.50 mm)	KIT CALES (0.10 - 0.50 mm)
30	REC93306-210U0	93306-210U0	COJINETE	BEARING	CUSCINETTO	ROULEMENT
31	REC93211-04384	93211-04384	TÓRICA	O-RING	O-RING	JOINT TORIQUE
32	REC93315-43061	93315-43061	COJINETE	BEARING	CUSCINETTO	ROULEMENT
33	REC93101-30M17	93101-30M17	RETÉN DE ACEITE	OIL SEAL	PARAOLIO	ROULEMENT
34	REC69J-45361-00-8D	69J-45361-00-8D	FUNDA INFERIOR	CAO LOWER CASING	COVER INFERIORE	COUVERCLE INFERIEUR
35	PAF4-04000001	97095-08020	PERNO	STUD	BULLONE	BOULON
36	REC688-45997-00	688-45997-01	ESPACIADOR AP	DISTANCE WASHER	DISTANZIALE	BRIDE
37	REC92990-18200	92990-18200	ARANDELA PLANA	WASHER	RONDELLA	RONDELLE
38	REC90171-18M04	90171-18M04	TUERCA	LOCK NUT	DADO	ÉCROU
39	REC91490-40030	91490-40030	PASADOR	PIN	SPINOTTO	CLAVETTE

			CONTRA ROTACIÓN	COUNTER ROTATION	CONTRO ROTANTE	CONTRE ROTATION
40	REC61A-45567-00/60-0	61A-45567-00	KIT GRUESOS (0.10-0.50 mm)	KIT SHIM (0.10-0.50 mm)	KIT SPESSORE (0.10-0.50 mm)	KIT CALES (0.10 - 0.50 mm)
41	REC93332-00048	93332-00048	COJINETE	BEARING	CUSCINETTO	ROULEMENT
42	REC69K-45611-00	69K-45611-00	EJE	SHAFT	ASSE	ARBRE D'HELICE

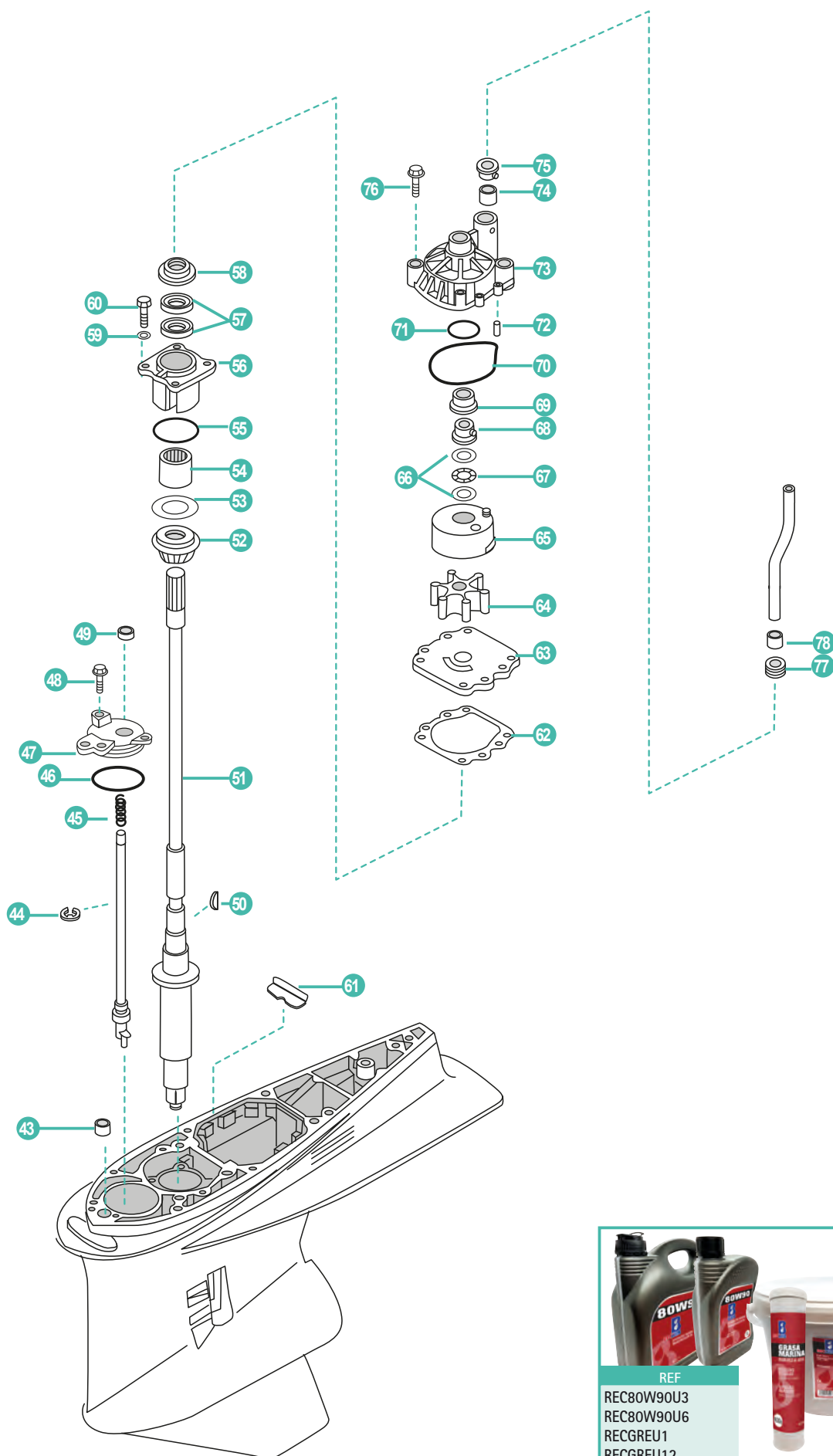

	REF	OEM				
43	REC663-44366-00	663-44366-00	RETEN TUBO AGUA	DAMPER, WATER SEAL	GHIERA	JOINT DE TUBE D'EAU
44	REC99001-08600-00	99001-08600	CLIP	CLIP	CLIP	CLIP
45	REC90501-11M10-00	90501-11M10	RESORTE DE COMPRESIÓN	SPRING	MOLLA	RESSORT
46	REC93210-65752-00	93210-64488	TÓRICA	O-RING	O-RING	JOINT TORIQUE
47	REC61A-45321-01	61A-45321-01	TAPA CAMBIO	SHIFT SHAFT COVER	SHIFT SHAFT COVER	COUVERCLE ARBRE DE TRANSMISSION
48	REC90119-06M10	90119-06M10	TORNILLO CON ARANDELA	SCREW WITH WASHER	VITE CON RONDELLA	VIS AVEC RONDELLE
49	REC93106-09014	93106-09014	RETÉN DE ACEITE	OIL SEAL	PARAOLIO	ROULEMENT
50	REC90280-04M05	90280-04M05	CUÑA	KEY WOODRUFF	CHIAVETTA	CLAVETTE
51	REC63P-45501-00	63P-45501-00	EJE TRASMISION 20"	DRIVE SHAFT 20"	ALBERO DI TRASMISSIONE 20"	ARBRE TRASMISION 20"
	REC63P-45501-10	63P-45501-10	EJE TRASMISION 25"	DRIVE SHAFT 25"	ALBERO DI TRASMISSIONE 25"	ARBRE TRASMISION 25"
52	REC93341-93020	93341-93020	COJINETE	BEARING	CUSCINETTO	CLAVETTE
53	REC61A-45587-00/60-0	61A-45587-00	KIT GRUESOS (0.10-0.50 mm)	KIT SHIM (0.10-0.50 mm)	KIT SPESSORE (0.10-0.50 mm)	KIT CALES (0.10 - 0.50 mm)
54	REC93317-330U2	93317-330U2	COJINETE	BEARING	CUSCINETTO	ROULEMENT
55	REC93210-54534	93210-54534	TÓRICA	O-RING	O-RING	JOINT TORIQUE
56	REC61A-45331-00-94	61A-45331-00-94	DIÁBOLO	GEAR HOUSING	DIABOLO	DIABOLO
57	REC93101-28M16	93101-28M16	RETÉN DE ACEITE	OIL SEAL	PARAOLIO	JOINT SPI
58	REC6E5-45344-00	6E5-45344-00	CUBIERTA SELLO DE ACEITE	RETAINER	COPERCHIO PARAOLIO	RETENUE
59	PAGB/T97.1-8	92995-08600	ARANDELA	WASHER	RONDELLA	RONDELLE
60	PAGB/T5783-M8X25	97095-08025	PERNO	STUD	BULLONE	BOULON
61	REC61A-45376-00-94	61A-45376-00	GUÍA SELLO DE GOMA	GUIDE	GUIDE	GUIDE
62	REC6E5-44315-A0	6E5-44315-A0	JUNTA	GASKET	GUARNIZIONE	JOINT
63	REC6G5-44323-00	6G5-44323-00	TAPA BOMBA	OUTER PLATE	COPERCHIO POMPA	PLAQUE DE POMPE À EAU
64	REC6E5-44352-01	6E5-44352-01	TURBINA	IMPELLER	GIRANTE	TURBINE
65	REC61A-44322-02	61A-44322-02	TAPA, BOMBA AGUA	COVER, INNER WATER PUMP	COPERCHIO, POMPE ACQUA	INSERT DE POMPE À EAU
66	REC90201-22M01	90201-22M01	ARANDELA	WASHER	RONDELLA	RONDELLE
67	REC90206-22M19	90206-22M19	ARANDELA ONDULADA	WAVE WASHER	RONDELLA ONDULATA	RONDELLE
68	REC61A-45538-00	61A-45538-00	ESPACIADOR	SPACER	SPESSORE	ENTRETOISE
69	REC61A-45527-00	61A-45527-00	CASQUILLO CUERPO BOMBA	COLLAR	BOCCOLA CORPO POMPA	BAGUE POMPE À EAU
70	REC93210-86M38	93210-86M38	TÓRICA	O-RING	O-RING	JOINT TORIQUE
71	REC93210-37160	93210-37160	TÓRICA	O-RING	O-RING	JOINT TORIQUE
72	REC93606-12019	93606-12019	PASADOR	PIN	SPINOTTO	PIN
73	REC61A-44311-00	61A-44311-01	CUERPO BOMBA AGUA	HOUSING, WATER PUMP	CORPO POMPA	CORPS DE POMPE À EAU
74	REC6E5-44365-00	6E5-44365-00	GOMA DEL SELLO DE AGUA	DAMPER WATER TUBE	GUARNIZIONE	BAGUE DE TUBE D'EAU
75	REC6E5-44312-00	6E5-44312-00	CUBIERTA CAJA DE BOMBA DE AGUA	WATER PUMP COVER	COPERCHIO POMPA ACQUA	BAGUE DE POMPE À EAU
76	REC90119-08M14	90119-08M14	TORNILLO CON ARANDELA	SCREW WITH WASHER	VITE CON RONDELLA	VIS AVEC RONDELLE
77	REC6E5-44366-00	6E5-44366-00	GOMA DEL SELLO DE AGUA	DAMPER WATER TUBE	GUARNIZIONE	BAGUE DE TUBE D'EAU
78	REC6E5-44365-00	6E5-44365-00	GOMA TUBO AGUA	DAMPER WATER TUBE	GOMMA TUBO ACQUA	BAGUE DE TUBE D'EAU

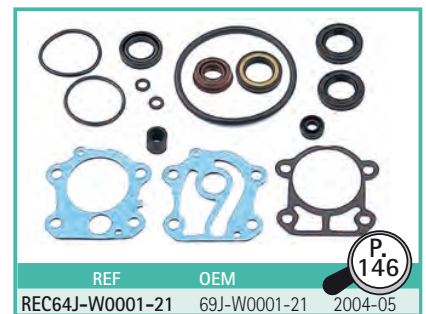
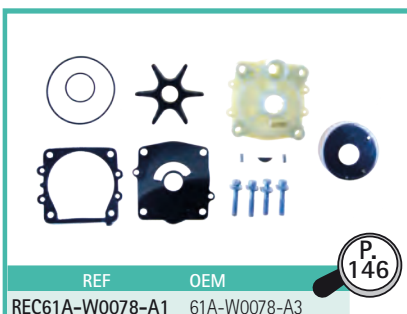



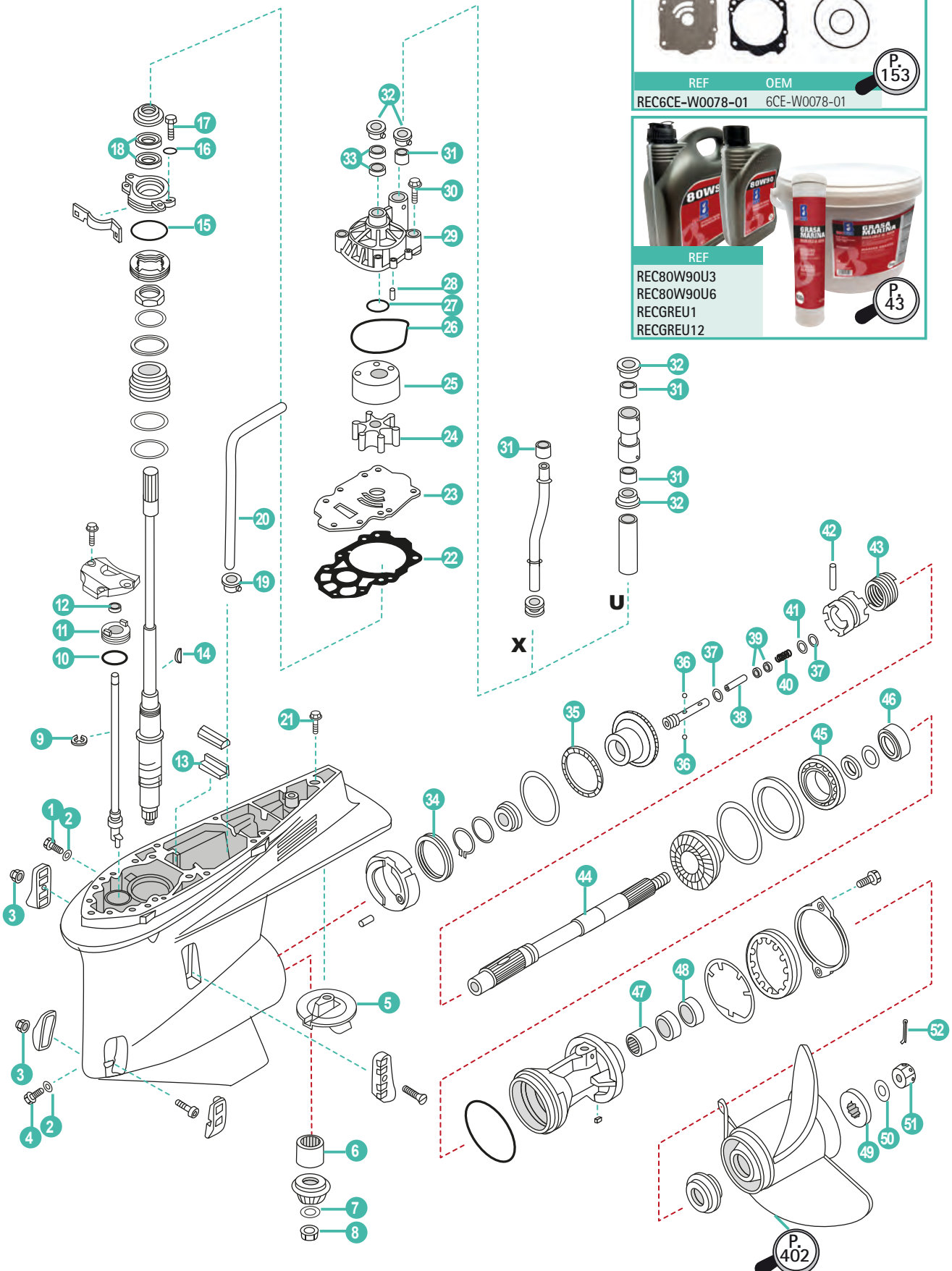

REF	OEM
REC6CE-W0078-01	6CE-W0078-01

P. 153

REF
REC80W90U3
REC80W90U6
RECGREU1
RECGREU12

P. 43

	REF	OEM				
1	REC90340-08002	90304-08002	TORNILLO DRENAJE	BOLT, DISCHARGING OIL	VITE DRENAGGIO	BOUCHON DE VIDANGE
2	REC90430-08020	90430-08020	JUNTA	GASKET	GUARNIZIONE	JOINT
3	PAGB/T6182-M5	90185-05002	TUERCA	LOCK NUT	DADO	ÉCROU
4	REC688-45341-00	688-45341-10	TORNILLO DRENAJE	BOLT, DISCHARGING OIL	VITE DRENAGGIO	BOUCHON DE VIDANGE
5	CM61A-45371-00A	61A-45371-00	ÁNODO	ANODE	ANODO	ANODE
6	REC93311-83280	93311-83280	COJINETE	BEARING	CUSCINETTO	ROULEMENT
7	REC90201-16M00	90201-16M00	ARANDELA	WASHER	RONDELLA	RONDELLE
8	REC90170-16M19	90170-16M19	TUERCA	LOCK NUT	DADO	ÉCROU
9	REC99001-08600-00	99001-08600	ARANDELA	WASHER	RONDELLA	RONDELLE
10	PAJASOF404-19-033	93210-33M49	TÓRICA	O-RING	O-RING	JOINT TORIQUE
11	REC65N-45321-00	65N-45321-00	TAPA SELECTOR	PLATE	COPERCHIO SELETTORE	COUVERCLE DU SELECTEUR
12	REC93106-09014	93106-09014	RETÉN DE ACEITE	OIL SEAL	PARAOLIO	JOINT SPI
13	REC663-45376-00	663-45376-00	GUÍA DE SELLO DE GOMA	GUIDE RUB. SEAL	GUIDA PARAOLIO	GUIDE
14	REC90280-04002	90280-04002	CUÑA	KEY WOODRUFF	CHIAVETTA	CLAVETTE
15	REC93210-65752-00	93210-64488	TÓRICA	O-RING	O-RING	JOINT TORIQUE
16	PAGB/T97.1-8	92995-08600	ARANDELA	WASHER	RONDELLA	RONDELLE
17	PAF4-04000001	97095-08020	PERNO	STUD	BULOONE	BOULON
18	REC93101-28M16	93101-28M16	RETÉN DE ACEITE	OIL SEAL	PARAOLIO	JOINT SPI
19	REC6D0-44367-00	6D0-44367-00	GOMA DEL SELLO DE AGUA	DAMPER, WATER SEAL	GOMMA TUBO ACQUA	MANCHON TUBE D'EAU
20	REC6D0-44362-01	6D0-44362-01	TUBO DE AGUA	WATER TUBE	TUBO ACQUA	DURITE D'EAU
21	PAT85-00000012	90105-10M00	TORNILLO	BOLT	VITE	VIS
22	REC6CE-44315-00	6CE-44315-00	JUNTA	GASKET	GUARNIZIONE	JOINT
23	REC6CE-44323-01	6CE-44323-01	TAPA BOMBA	OUTER PLATE, CARTRIDGE	COPERCHIO POMPA ACQUA	PLAQUE DE POMPE À EAU
24	REC6CE-44352-00	6CE-44352-01	TURBINA	IMPELLER	GIRANTE	TURBINE
25	REC6AW-44322-00	6AW-44322-00	TAPA, BOMBA AGUA	COVER, INNER WATER PUMP	COPERCHIO, POMPE ACQUA	INSERT DE POMPE À EAU
26	REC93210-94003	93210-94003	TÓRICA	O-RING	O-RING	JOINT TORIQUE
27	REC93210-37160	93210-37160	TÓRICA	O-RING	O-RING	JOINT TORIQUE
28	REC93606-12019	93606-12019	PASADOR	PIN	SPINOTTO	PIN
29	REC6CE-44311-01	6CE-44311-01	CUERPO BOMBA AGUA	HOUSING, WATER PUMP	CORPO POMPA	CORPS DE POMPE À EAU
30	REC90119-08M14	90119-08M14	TORNILLO CON ARANDELA	SCREW WITH WASHER	VITE CON RONDELLA	VIS AVEC RONDELLE
31	REC6AW-44365-00	6AW-44365-00	GOMA DEL SELLO DE AGUA	DAMPER, WATER SEAL	ANELLO TUBO ACQUA	RETENUE TUBE D'EAU
32	REC6AW-44312-00	6AW-44312-00	CUBIERTA CAJA DE BOMBA DE AGUA	WATER PUMP COVER	COPERCHIO POMPA ACQUA	BAGUE DE POMPE À EAU
33	REC93104-22M07	93104-22M07	RETÉN DE ACEITE	OIL SEAL	PARAOLIO	ROULEMENT
34	REC93311-85894	93311-85894	COJINETE	BEARING	CUSCINETTO	ROULEMENT
35	REC93340-67011	93340-67011	COJINETE	BEARING	CUSCINETTO	ROULEMENT
36	REC93501-04011	93501-04011	ESFERA	BALLE	SFERA	BILLE
37	REC90183-02M03	90183-02M03	TUERCA DE RESORTE	SPRING NUT	DADO MOLLA	RONDELLE FREIN
38	REC6H1-45668-00	6H1-45668-00	EJE	SHAFT	ASSE	ARBRE
39	REC61A-45635-00	61A-45635-00	ÉMBOLO DE CAMBIO	SHIFT PLUNGER	GUARNIZIONE	SHIFT
40	REC90501-10M77	90501-10M77	RESORTE DE COMPRESIÓN	SPRING	MOLLA	RESSORT
41	REC90201-02M00	90201-02M00	ARANDELA PLANA	WASHER	RONDELLA	RONDELLE
42	REC90250-08M07	90250-08M07	PASADOR	PIN	SPINOTTO	PIN
43	REC6E5-45633-01	6E5-45633-01	ANILLO DEL PASADOR	ANULAR SPRING, CLUTCH	ANELLO	RESSORT
44	REC6CB-45611-00	6CB-45611-00	EJE	SHAFT	ASSE	ARBRE D'HELICE
45	REC93306-209U0	93306-209U0	COJINETE	BEARING	CUSCINETTO	ROULEMENT
46	REC93332-000A5	93332-000A5	COJINETE	BEARING	CUSCINETTO	ROULEMENT
47	REC93315-43061	93315-43061	COJINETE	BEARING	CUSCINETTO	ROULEMENT
48	REC93101-30002	93101-30002	RETÉN DE ACEITE	OIL SEAL	PARAOLIO	JOINT SPI
49	REC688-45997-00	688-45997-01	ESPACIADOR	SPACER	SPESSORE	ENTRETOISE
50	REC92990-18200	92990-18200	ARANDELA PLANA	WASHER	RONDELLA	RONDELLE
51	REC90171-18M04	90171-18M04	TUERCA	LOCK NUT	DADO	ÉCROU
52	REC91490-40030	91490-40030	PASADOR	PIN	SPINOTTO	CLAVETTE

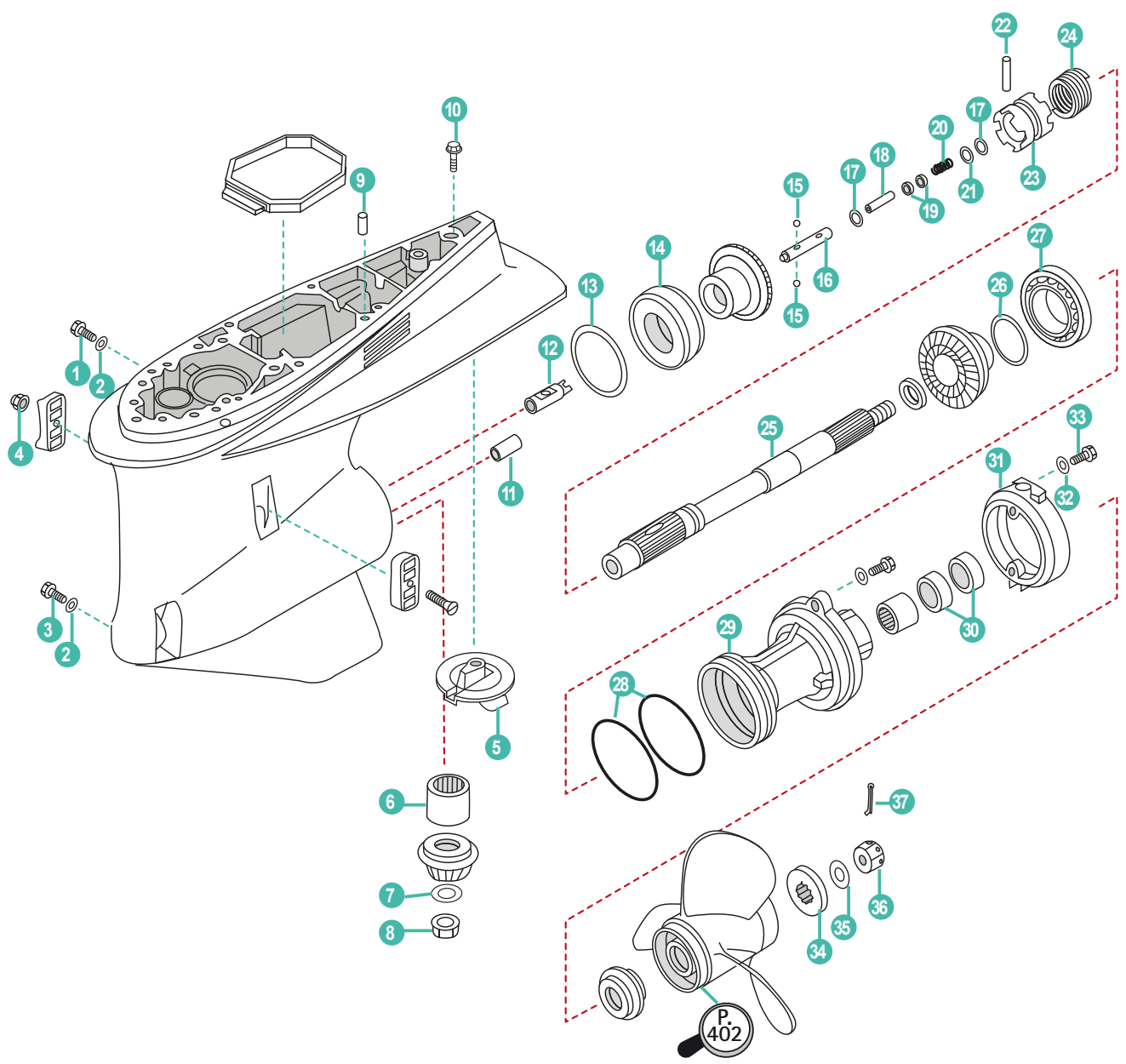

REF	OEM
REC6P2-W0078-00	61P2-W0078-00

P. 153

REF
REC80W90U3
REC80W90U6
RECGREU1
RECGREU12

P. 43

	REF	OEM				
1	REC90340-08002	90304-08002	TORNILLO DRENAJE	BOLT, DISCHARGING OIL	VITE DRENAGGIO	VIS DE VIDANGE
2	REC90430-08020	90430-08020	JUNTA	GASKET	GUARNIZIONE	JOINT
3	REC688-45341-00	688-45341-10	TORNILLO DRENAJE	BOLT, DISCHARGING OIL	VITE DRENAGGIO	VIS DE VIDANGE
4	PAGB/T6182-M5	90185-05002	TUERCA	LOCK NUT	DADO	ÉCROU
5	CM61A-45371-00A	61A-45371-00	ÁNODO	ANODE	ANODO	ANODE
6	REC93311-83280	93311-83280	COJINETE	BEARING	CUSCINETTO	PALIER
7	REC90201-16M00	90201-16M00	ARANDELA	WASHER	RONDELLA	RONDELLE
8	REC90170-16M19	90170-16M19	TUERCA	LOCK NUT	DADO	ÉCROU
9	REC93608-12M05	93608-12M05	PASADOR	PIN	SPINOTTO	LEVIER
10	PAT85-00000012	90105-10M00	TORNILLO	SCREW	VITE	VIS
11	REC99590-10114	99590-10114	PASADOR	PIN	SPINOTTO	LEVIER
12	REC61A-45641-02	61A-45641-02	CAMBIO	SHIFTER	CAMBIO	SHIFTER
13	REC61A-45567-00/60-0	61A-45567-00	KIT GRUESOS (0.10-0.50 mm)	KIT SHIM (0.10-0.50 mm)	KIT SPESSORE (0.10-0.50 mm)	KIT CALES (0.10 - 0.50 mm)
14	REC93332-000W1	93332-000W1	COJINETE	BEARING	CUSCINETTO	ROULEMENT
15	REC93501-04011	93501-04011	ESFERA	BALL	SFERA	BILLE
16	REC61A-45634-01	61A-45634-01	DESLIZADOR CAMBIO	SHIFT SLIDE	SPINOTTO SCORREVOLE	SHIFT
17	REC90183-02M03	90183-02M03	TUERCA DE RESORTE	SPRING NUT	DADO MOLLA	RONDELLE FREIN
18	REC6H1-45668-00	6H1-45668-00	EJE	SHAFT	ASSE	ARBRE
19	REC61A-45635-00	61A-45635-00	DESLIZADOR CAMBIO	SHIFT SLIDE	SPINOTTO	SHIFT
20	REC90501-10M77	90501-10M77	RESORTE DE COMPRESIÓN	SPRING	MOLLA	RESSORT
21	REC90201-02M00	90201-02M00	ARANDELA PLANA	WASHER	RONDELLA	RONDELLE
22	REC61A-45632-00	61A-45632-00	PASADOR	PIN	SPINOTTO	PIN
23	REC69J-45631-00	69J-45631-00	EMBRAGUE DE GARRA	CLUTH	SELETTORE	CRABOT
24	REC61A-45633-00	61A-45633-00	ANILLO DEL PASADOR	ANNULAR SPRING, CLUTCH	ANELLO	RESSORT
25	REC69J-45611-00	69J-45611-00	EJE	SHAFT	ASSE	ARBRE
	REC69K-45611-00	69K-45611-00	EJE CONTRARROTACIÓN	CR SHAFT	ASSE CR	ARBRE D'HELICE CR
26	REC61A-45577-00/60-0	61A-45577-00	KIT GRUESOS (0.10-0.50 mm)	KIT SHIM (0.10-0.50 mm)	KIT SPESSORE (0.10-0.50 mm)	KIT CALES (0.10 -0.50 mm)
27	REC93306-210U0	93306-210U0	COJINETE	BEARING	CUSCINETTO	ROULEMENT
28	REC93211-04384	93211-04384	TÓRICA	O-RING	O-RING	JOINT TORIQUE
29	REC6D0-45332-00-CA	6D0-45332-00-CA	DIÁBOLO	GEAR HOUSING	DIABOLO	DIABOLO
30	REC93101-30002	93101-300002	RETÉN DE ACEITE	OIL SEAL	PARAOLIO	JOINT SPI
31	REC6D0-45361-00-8D	6D0-45361-00-8D	FUNDA INFERIOR	CAO LOWER CASING	COVER INFERIORE	COUVERCLE INFERIEUR
32	PAF4-04000001	97095-08020	PERNO	BOLT	BULONE	BOULON
33	PAGB/T97.1-8	92995-08600	ARANDELA	WASHER	RONDELLA	RONDELLE
34	REC688-45997-00	688-45997-01	ESPACIADOR	SPACER	SPESSORE	CALES
35	REC92990-18200	92990-18200	ARANDELA PLANA	WASHER	RONDELLA	RONDELLE
36	REC90171-18M04	90171-18M04	TUERCA	LOCK NUT	DADO	ÉCROU
37	REC91490-40030	91490-40030	PASADOR	PIN	SPINOTTO	CLAVETTE



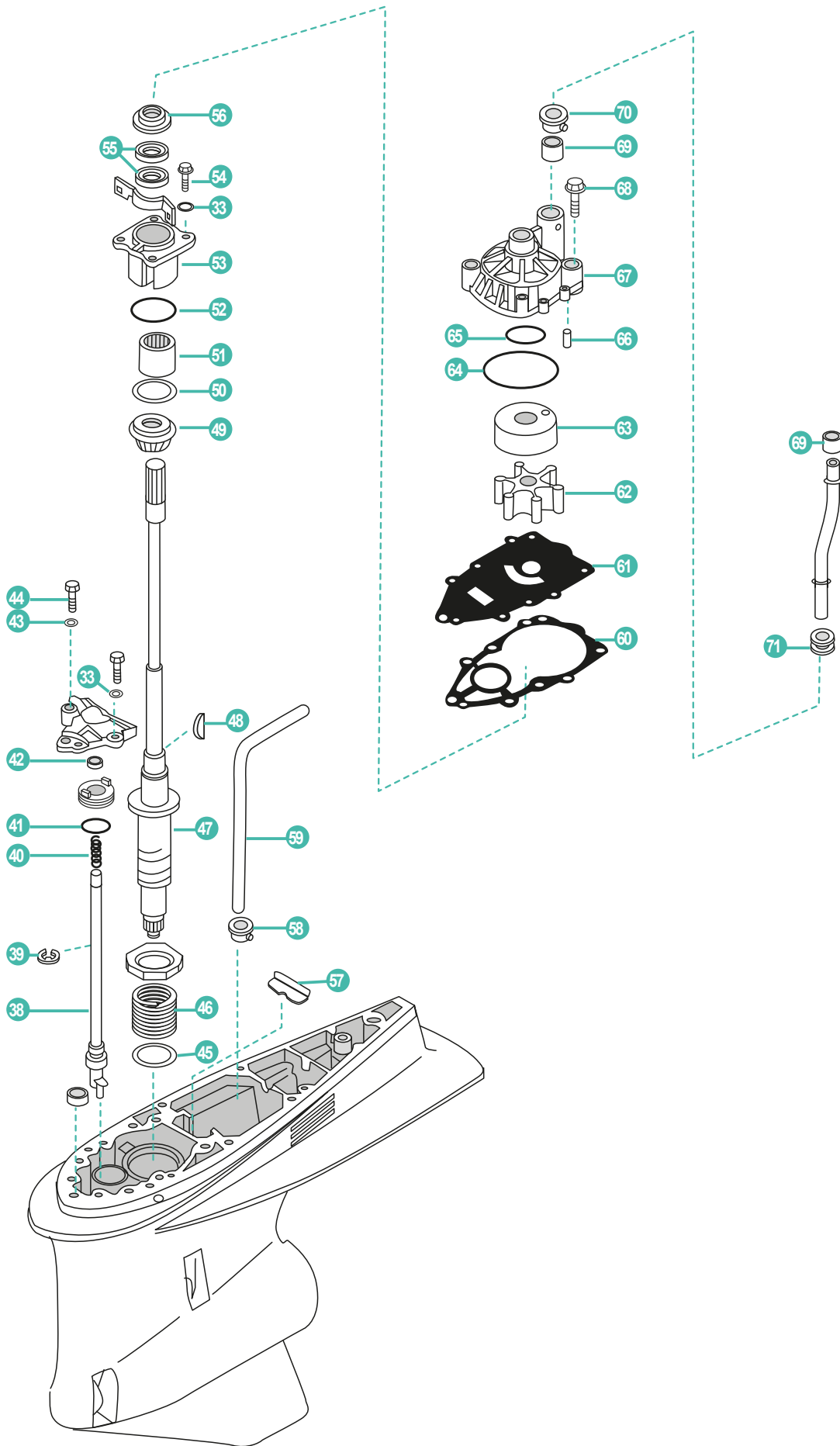

	REF	OEM				
38	REC6P2-44150-00	6P2-44150-00	VARILLA SELECTOR	SHIFT CAM ASSY	ASTA SELETTORE	TIGE DE SELECTEUR
39	REC99001-08600-00	99001-08600	CLIP	CLIP	RONDELLA	CLIP
40	REC90501-11M10-00	90501-11M10	RESORTE DE COMPRESIÓN	SPRING	MOLLA	RESSORT
41	PAJASOF404-19-033	93210-33M49	TÓRICA	O-RING	O-RING	JOINT TORIQUE
42	REC93106-09014	93106-09014	RETÉN DE ACEITE	OIL SEAL	PARAOLIO	ROULEMENT
43	PAGB/T97.1-6	92995-06600	ARANDELA	WASHER	RONDELLA	RONDELLE
44	PAGB/T5783-M6X16	97095-06016	PERNO	BOLT	BULLONE	BOULON
45	REC90201-42014	90201-42014	ARANDELA PLANA	WASHER	RONDELLA	RONDELLE
46	REC90501-450A2	90501-450A2	RESORTE	SPRING	MOLLA	RESSORT
47	REC6P2-45501-11	6P2-45501-10	EJE TRANSMISION U (30.3")	DRIVE SHSFT U (30.3")	ASSE TRASMISSIONE U (30.3")	ARBRE DE TRANSMISSION U (30.3")
	REC6P2-45501-01	6P2-45501-00	EJE TRANSMISION X (25.3")	DRIVE SHSFT X (25.3")	ASSE TRASMISSIONE X (25.3")	ARBRE DE TRANSMISSION X (25.3")
48	REC90280-04M05	90280-04M05	CUÑA	KEY WOODRUFF	CHIAVETTA	CLAVETTE
49	REC93341-93020	93341-930U9	COJINETE	BEARING	CUSCINETTO	ROULEMENT
50	REC61A-45587-00/60-0	61A-45587-00	KIT GRUESOS (0.10-0.50 mm)	KIT SHIM (0.10-0.50 mm)	KIT SPESSORE (0.10-0.50 mm)	KIT CALES (0.10 - 0.50 mm)
51	REC93317-330U2	93317-330U2	COJINETE	BEARING	CUSCINETTO	ROULEMENT
52	REC93210-54534	93210-54534	TÓRICA	O-RING	O-RING	JOINT TORIQUE
53	REC6P2-45331-00-9S	6P2-45331-00-9S	CAJA DE COJINETE	HOUSING, BEARING	SCATOLA CUSCINETTO	PALIER DE ROULEMENT
54	PAGB/T5783-M8X25	97095-08025	PERNO	BOLT	BULLONE	BOULON
55	REC93101-28M16	93101-28M16	RETÉN DE ACEITE	OIL SEAL	PARAOLIO	JOINT SPI
56	REC6E5-45344-00	6E5-45344-00	TAPA RETEN	RETAINER	COPERCHIO PARAOLIO	RETENUE
57	REC61A-45376-00-94	61A-45376-00	GUÍA SELLO DE GOMA	GUIDE	GUIDA	GUIDE
58	REC6D0-44367-00	6D0-44367-00	GOMA TUBO AGUA	DAMPER, WATER SEAL	GOMMA TUBO ACQUA	MANCHON TUBE D'EAU
59	REC6D0-44362-01	6D0-44362-01	TUBO DE AGUA	WATER TUBE	TUBO ACQUA	TUBE D'EAU
60	REC60X-44315-A0	60X-44315-A0	JUNTA	GASKET	GUARNIZIONE	JOINT
61	REC6P2-44323-00	6P2-44323-00	PLACA EXTERIOR DEL CARTÚCHO	OUTER PLATE	PLACCA ESTERNA	PLAQUE DE POMPE À EAU
62	REC6E5-44352-01	6E5-44352-01	TURBINA	IMPELLER	GIRANTE	TURBINE
63	REC61A-44322-02	61A-44322-02	TAPA, BOMBA AGUA	COVER, INNER WATER PUMP	COPERCHIO, POMPE ACQUA	INSERT DE POMPE À EAU
64	REC93210-86M38	93210-86M38	TÓRICA	O-RING	O-RING	JOINT TORIQUE
65	REC93210-37160	93210-37160	TÓRICA	O-RING	O-RING	JOINT TORIQUE
66	REC93606-12019	93606-12019	PASADOR	PIN	SPINOTTO	PIN
67	REC61A-44311-00	61A-44311-01	CUERPO BOMBA AGUA	HOUSING, WATER PUMP	CORPO POMPA	CORPS DE POMPE À EAU
68	REC90119-08M14	90119-08M14	TORNILLO CON ARANDELA	SCREW WITH WASHER	VITE CON RONDELLA	VIS AVEC RONDELLE
69	REC6E5-44365-00	6E5-44365-00	GOMA DEL SELLO DE AGUA	DAMPER, WATER SEAL	ANELLO TUBO ACQUA	RETENUE TUBE D'EAU
70	REC6E5-44312-00	6E5-44312-00	CUBIERTA CAJA DE BOMBA DE AGUA	WATER PUMP COVER	COPERCHIO POMPA ACQUA	GUIDE DE POMPE À EAU
71	REC6E5-44366-00	6E5-44366-00	GOMA DEL SELLO DE AGUA	DAMPER, WATER SEAL	ANELLO TUBO ACQUA	RETENUE TUBE D'EAU
	REC422-B25F	6P2-45300-20-8D 6P2-45300-21-8D	CONJUNTO INFERIOR	COMPLETE GEARCASE	PIEDE COMPLETO	EMBASE COMPLETE
	REC429-B25F	6P3-45300-40-8D 6P3-45300-41-8D	CONJUNTO INFERIOR CONTRA ROTACIÓN	COMPLETE GEARCASE COUNTER ROTATION	PIEDE COMPLETO CONTRO ROTANTE	EMBASE COMPLETE CONTRE ROTATION

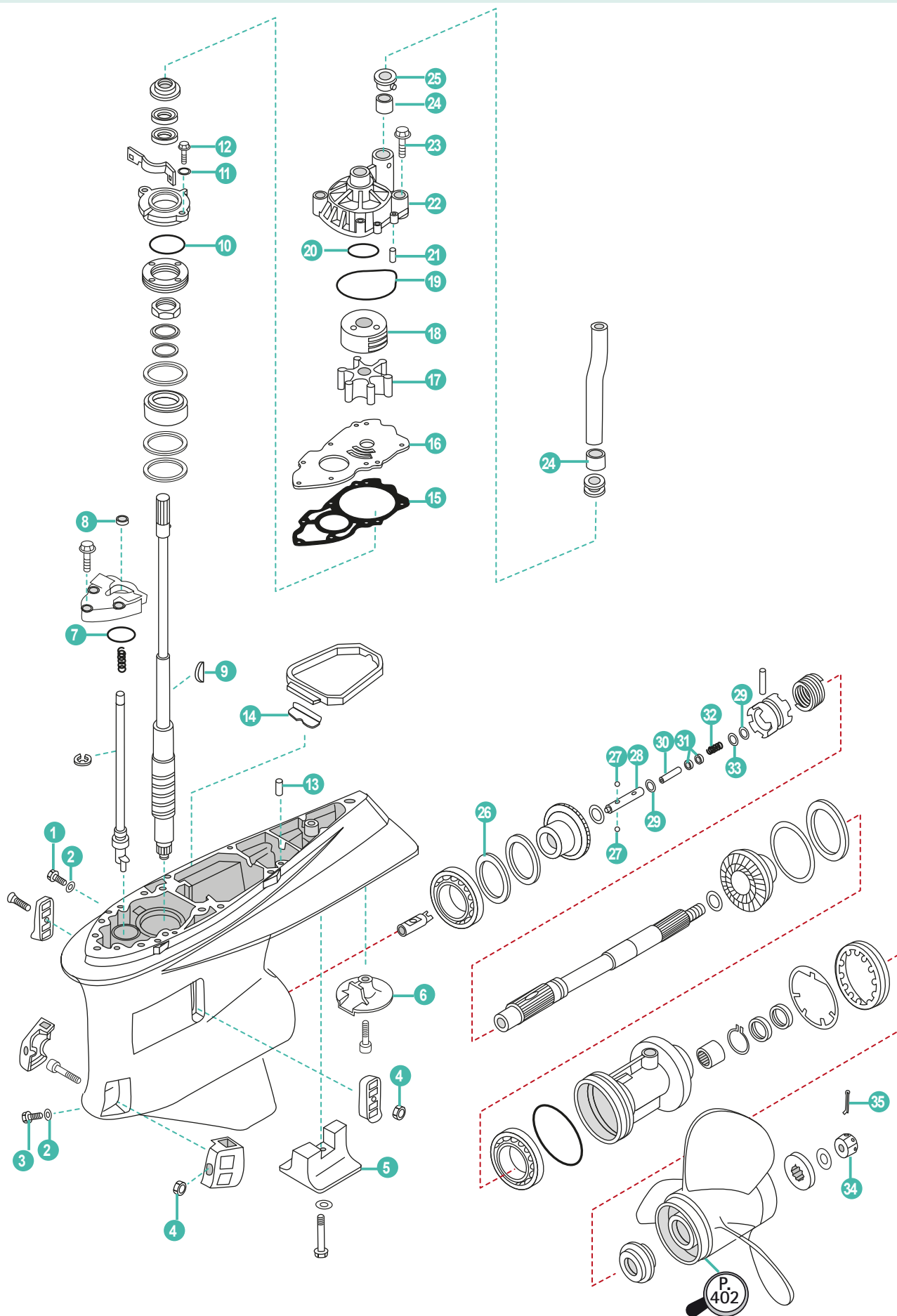

	REF	OEM				
1	REC90340-08002	90304-08002	TORNILLO DRENAJE	BOLT, DISCHARGING OIL	VITE DRENAGGIO	BOUCHON DE VIDANGE
2	REC90430-08020	90430-08020	JUNTA	GASKET	GUARNIZIONE	JOINT
3	REC688-45341-00	688-45341-10	TORNILLO DRENAJE	BOLT, DISCHARGING OIL	VITE DRENAGGIO	BOUCHON DE VIDANGE
4	PAGB/T6182-M5	90185-05002	TUERCA	LOCK NUT	DADO	ÉCROU
5	CM6AW-45373-00A	6AW-45373-00	ÁNODO	ANODE	ANODO	ANODE
6	CM6AW-45619-00A	6AW-45619-00	ÁNODO	ANODE	ANODO	ANODE
7	REC93210-48214	93210-48214	TÓRICA	O-RING	O-RING	JOINT TORIQUE
8	REC93101-12M70	93101-12M70	RETÉN DE ACEITE	OIL SEAL	PARAOILIO	JOINT SPI
9	REC6AW-44336-00	6AW-44336-00	CUÑA	KEY WOODRUFF	CHIAVETTA	CLAVETTE
10	REC93210-69MG6	93210-69MG6	TÓRICA	O-RING	O-RING	JOINT TORIQUE
11	PAGB/T97.1-8	92995-08600	ARANDELA	WASHER	RONDELLA	RONDELLE
12	PAF4-04000001	97095-08020	PERNO	BOLT	BULLONE	BOULON
13	REC93608-12M05	93608-12M05	PASADOR	PIN	SPINOTTO	PIN
14	REC61A-45376-00-94	61A-45376-00-94	GUÍA DE SELLO DE GOMA	GUIDE	GUIDE	GUIDE
15	REC6AW-44315-00	6AW-44315-00	JUNTA	GASKET	GUARNIZIONE	JOINT
16	REC6AW-44323-00	6AW-44323-00	TAPA BOMBA	OUTER PLATE, CARTRIDGE	COPERCHIO POMPA D'ACQUA	PLAQUE DE POMPE À EAU
17	REC6AW-44352-00	6AW-44352-00	TURBINA	IMPELLER	GIRANTE	TURBINE
18	REC6AW-44322-00	6AW-44322-00	TAPA, BOMBA AGUA	COVER, INNER WATER PUMP	COPERCHIO, POMPE D'EAU	INSERT DE POMPE À EAU
19	REC93210-94003	93210-94003	TÓRICA	O-RING	O-RING	JOINT TORIQUE
20	REC93210-37160	93210-37160	TÓRICA	O-RING	O-RING	JOINT TORIQUE
21	REC93606-12019	93606-12019	PASADOR	PIN	SPINOTTO	PIN
22	REC6AW-44311-01	6AW-44311-00	CUERPO BOMBA AGUA	HOUSING, WATER PUMP	CORPO POMPA	CORPS DE POMPE À EAU
23	REC90119-08M14	90119-08M14	TORNILLO CON ARANDELA	SCREW WITH WASHER	VITE CON RONDELLA	VIS AVEC RONDELLE
24	REC6AW-44365-00	6AW-44365-00	GOMA DEL SELLO DE AGUA	DAMPER, WATER SEAL	ANELLO TUBO ACQUA	RETENUE TUBE D'EAU
25	REC6AW-44312-00	6AW-44312-00	CUBIERTA CAJA DE BOMBA DE AGUA	WATER PUMP COVER	COPERCHIO POMPA ACQUA	BAGUE DE POMPE À EAU
26	REC93340-67011	93340-67011	COJINETE	BEARING	CUSCINETTO	ROULEMENT
27	REC93501-04011	93501-04011	ESFERA	BALL	SFERA	BILLE
28	REC61A-45634-01	61A-45634-01	DESILIZADOR DE CAMBIO	SHIFT SLIDE	SCORREVOLE DEL CAMBIO	SHIFT
29	REC90183-02M03	90183-02M03	TUERCA DE RESORTE	SPRING NUT	DADO MOLLA	RONDELLE FREIN
30	REC6H1-45668-00	6H1-45668-00	EJE	SHAFT	ASSE	ARBRE
31	REC61A-45635-00	61A-45635-00	ÉMBOLO DE CAMBIO	SHIFT PLUNGER	GOMMINO	SHIFT
32	REC90501-10M77	90501-10M77	RESORTE DE COMPRESIÓN	SPRING	MOLLA	RESSORT
33	REC90201-02M00	90201-02M00	ARANDELA PLANA	WASHER	RONDELLA	RONDELLE
34	REC90171-18M04	90171-18M04	TUERCA	LOCK NUT	DADO	ÉCROU
35	REC91490-40030	91490-40030	PASADOR	PIN	SPINOTTO	CLAVETTE

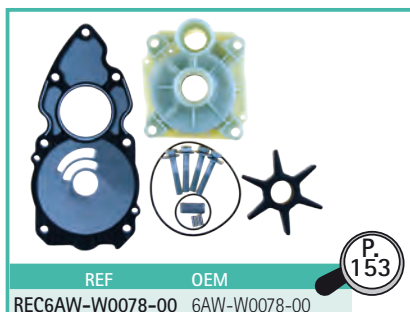



DESPIECE COLAS  
2 TIEMPOS

GEAR CASE PARTS  
2 STROKES

PARTI PIEDI  
2 TEMPI

PIECES D'EMBASES  
DE 2 TEMPS

2T 2HP • 2B • 2MSH • 2CMH  
STROKES

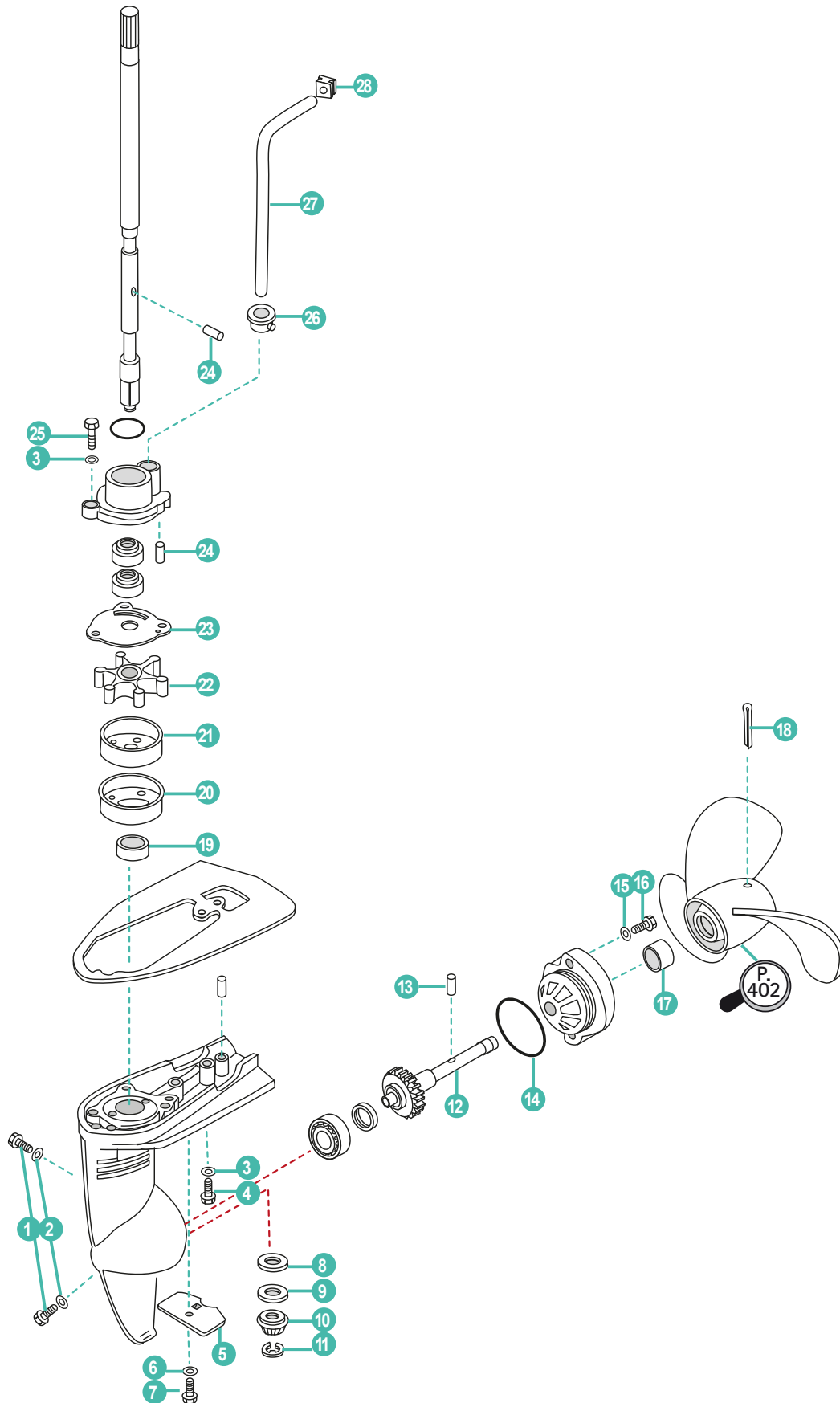

	REF	OEM				
1	REC90340-08002	90340-08M04	TORNILLO DRENAJE	BOLT, DISCHARGING OIL	VITE DRENAGGIO	BOUCHON DE VIDANGE
2	REC90430-08020	90430-08020	JUNTA	GASKET	GUARNIZIONE	JOINT
3	PAGB/T97.1-8	92995-08600	ARANDELA	WASHER	RONDELLA	RONDELLE
4	PAGB/T5783-M6X30	97095-06030	TORNILLO	BOLT	VITE	VIS
5	CM6L5-45251-02	6L5-45251-02	ÁNODO ZINC	ANODE	ANODO ZINCO	ANODE
6	PAGB/T861.1-87	92990-06300	ARANDELA	WASHER	RONDELLA	RONDELLE
7	PAGB/T5783-M6X35	95895-06012	TORNILLO	BOLT, FLANGE	VITE	VIS
8	PAF2.6-03000017	646-45534-00-03	GRUESO	SHIM	SPESSORE	CALE
9	PAF4-03000006	90201-11M49	ARANDELA	WASHER	RONDELLA	RONDELLE
10	REC646-45551-00	646-45551-00	PIÑÓN ATAQUE	INITIATIVE GEAR	MARCIA INIZIATIVA	PIGNON D'ATTAQUE
11	PAGB/T896-86	93430-06005	CLIP	CIRCLIP	CLIP	CLIP
12	REC646-45560-00	646-45560-00	ENGRANAJE CON EJE	GEAR WITH SHAFT	IGRANAGGIO CON ASSE	PIGNON
13	REC90250-03M10	90250-03M10	PASADOR SEGURIDAD	PIN	SPINOTTO	LEVIER
14	REC93210-42101	93210-42101	ARO TÓRICA	O-RING	O-RING	JOINT TORIQUE
15	PAGB/T97.1-6	92990-06600	ARANDELA	WASHER	RONDELLA	RONDELLE
16	PAGB/T5783-M6X16	97090-06014	TORNILLO	BOLT	VITE	VIS
17	REC93103-10052	93103-10052	RETÉN	OIL SEAL	PARAOLIO	JOINT SPI
18	REC91490-30040	91490-30040	PASADOR ALETAS	PIN	SPINOTTO	PIN
19	REC93103-11051	93103-11051	RETÉN	OIL SEAL	PARAOLIO	JOINT D'HUILE
20	REC6A1-44325-00	6A1-44325-00P	CUERPO INF. BOMBA	PROTECTOR	CORPO INF. POMPA	BASE DE POMPE À EAU
21	REC646-44322-00	646-44322-00	CASQUILLO INOX. BOMBA	INSERT	GHIERA INOX. POMPA	INSERT DE POMPE À EAU
22	REC646-44352-01	646-44352-01	TURBINA	IMPELLER	GIRANTE	TURBINE
23	REC646-44322-00	646-44323-00	PLATO BOMBA AGUA	OUTER PLATE	PIASTRA POMPA ACQUA	PLAQUE DE POMPE À EAU
24	PAF2.6-03000013	93604-09068	PIN	PIN	SPINOTTO	PIN
25	PAGB/T5783-M5X16	97095-05016	TORNILLO	BOLT	VITE	VIS
26	REC646-44366-01	646-44366-01	RETÉN TUBO AGUA	SEAL WATER PIPE	ANELLO TUBO ACQUA	RETENUE TUBE D'EAU
27	REC6A1-44361-00	6A1-44361-00	TUBO AGUA	TUBE, WATER	TUBO ACQUA	TUBE D'EAU
28	REC646-44365-00	646-44365-00	RETÉN TUBO DE AGUA	I-SHAPED RUBBER BAND	ANELLO TUBO ACQUA	RETENUE TUBE D'EAU



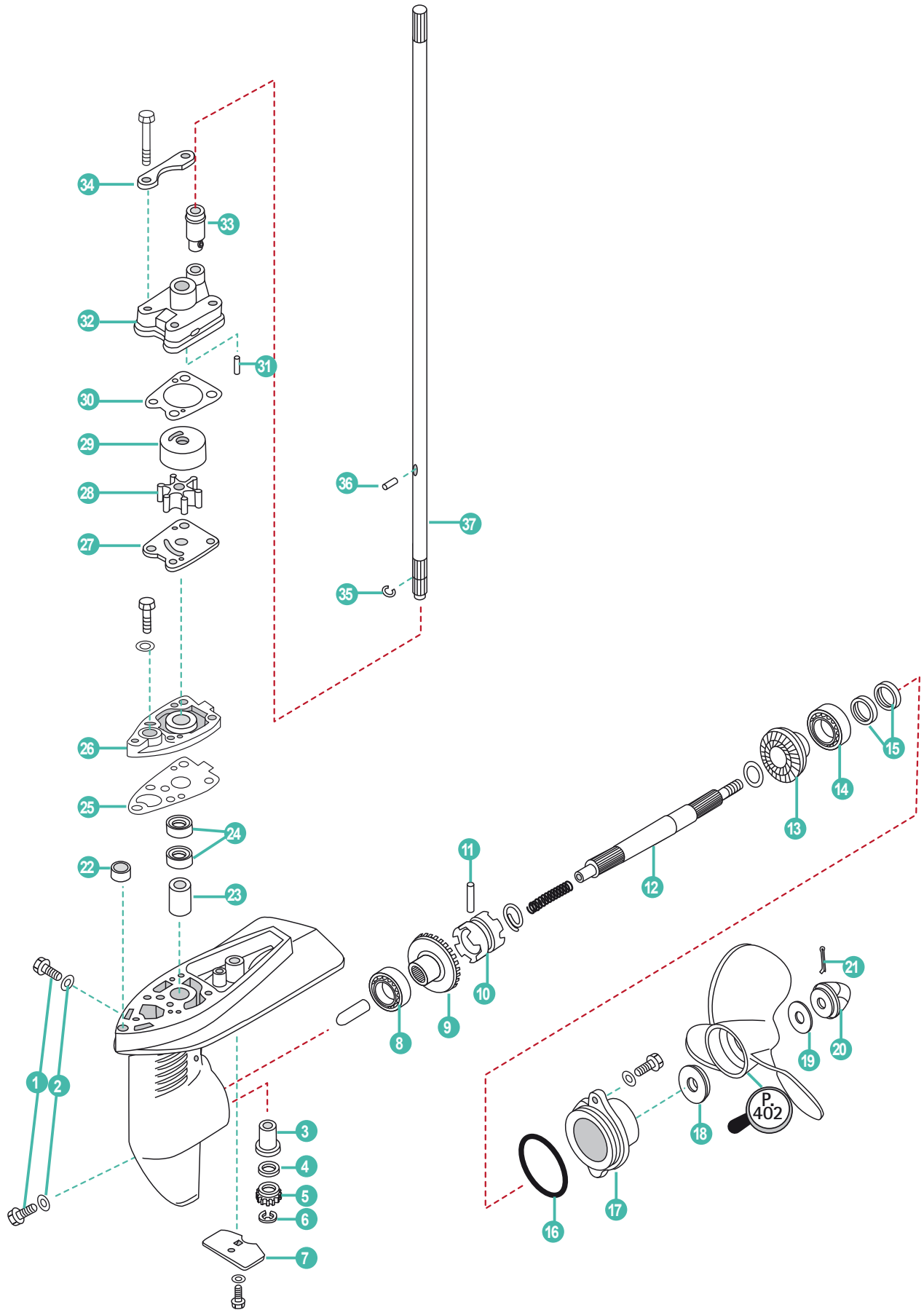

	REF	OEM				
1	REC90340-08002	90340-08002	TAPÓN ACEITE	PLUG, OIL	TAPPO OLIO	BOUCHON REMPLISSAGE D'HUILE
2	REC90430-08020	90430-08020	JUNTA	GASKET	GUARNIZIONE	JOINT
3	REC6E0-45317-00	6E0-45317-09	CASQUILLO EJE	BUSHING	CAPPUCCIO ASSE	BAGUE D'ARBRE
4	PAF4-03000006	90204-11M49	ARANDELA	WASHER	RONDELLA	RONDELLE
5	REC6E0-45551-00	6E0-45551-00	PIÑÓN ATAQUE	INITIATIVE GEAR	MARCIA INIZIATIVA	PIGNON D'ATTAQUE
6	PAGB/T896-86	99001-06600	CIRCLIP	CIRCLIP	CIRCLIP	CIRCLIP
7	CM6L5-45251-02	6L5-45251-03	ÁNODO	ZINC ANODE	ANODO ZINCO	ANODE
8	PAGB/T276-6004C2	93306-004U0	RODAMIENTO	BEARING	CUSCINETTO	ROULEMENT
9	REC6E0-45560-00	6E0-45560-00	PIÑÓN MARCHA AVANTE	POSITIVE GEAR ASSY	PIGNONE MARCIA AVANTI	PIGNON DE MARCHÉ AVANT
10	REC6E0-45631-00	6E0-45631-00	DESPLAZABLE	CLUTCH, DOG	SCORREVOLE	CRABOT
11	REC90250-05046	90250-05046	PASADOR	PIN STRAIGHT	SPINOTTO	PIN
12	REC6E0-45611-01	6E0-45611-01	EJE HÉLICE	SHAFT, PROPELLER	ASSE ELICA	ARBRE D'HELICE
13	REC6E0-45570-00	6E0-45570-00	PIÑÓN MARCHA ATRÁS	REVERSE GEAR	PIGNONE MARCIA INDIETRO	PIGNON MARCHÉ ARRIÈRE
14	PAGB/T276-6004C2	93306-004U0	RODAMIENTO	BEARING	CUSCINETTO	ROULEMENT
15	REC93101-13M12	93101-13M12	RETÉN	OIL SEAL	PARAOLIO	JOINT SPI
16	REC93210-48214	93210-48214	ARO TÓRICO	O-RING	O-RING	JOINT TORIQUE
17	PAF4-03050001	6E0-45361-01-4D	TAPA CÁRTER	COVER, LOWER CASING	COPERCHIO CARTER	COUVERCLE INFERIEUR EMBASE
18	PAF4-03000025	6L5-45987-01	ESPACIADOR	SPACER	DISTANZIALE	ENTRETOISE
19	PAF4-03000026	90201-08M54	ARANDELA INOX.	WASHER, STAINLESS STEEL	RONDELLA INOX.	RONDELLE INOX
20	REC647-45616-02	6L5-45616-02	TUERCA	NUT, PROPELLER	DADO	ÉCROU
21	PAGB/T91-1.6X12	91490-25030	PASADOR ALETAS	PIN, COTTER	SPINOTTO	PIN
22	PAF4-00000001	90387-06M14	COLLAR	COLLAR	COLLARE	GUIDE CREUX
23	REC6E0-45316-00	6E0-45316-09	CASQUILLO EJE	BUSHING	GHIERA ASSE	BAGUE BRONZE
24	REC93101-10M14	93101-10M14	RETÉN	OIL SEAL	PARAOLIO	JOINT SPI
25	PAF4-03000011	6E0-45315-A0	JUNTA	PACKING	GUARNIZIONE	JOINT
26	PAF4-03000012	6E0-45321-01-5B	BASE BOMBA DE AGUA	BASE, WATER PUMP	BASE POMPA ACQUA	BASE DE POMPE À EAU
27	PAF4-03000015	6E0-44323-00	PLACA	OUTER PLATE	PIASTRA	PLAQUE
28	REC6E0-44352-00	6E0-44352-00	IMPULSOR	IMPELLER	GIRANTE	TURBINE
29	REC6E0-44322-02	6E0-44322-02	CASQUILLO INOX	CARTRIDGE INSERT	CAPPUCCIO	INSERT DE POMPE À EAU
30	PAF4-03000018	6E0-44315-A0	JUNTA BOMBA	GASKET	GUARNIZIONE POMPA	JOINT DE POMPE
31	PAF4-03000013	93604-18080	PIN	PIN, DOWEL	SPINOTTO	PIN
32	PAF4-03000019	6E0-44311-00	CUERPO BOMBA	HOUSING, WATER PUMP	CORPO POMPA	CORPS DE POMPE À EAU
33	PAF4-03000021	6E0-44366-00	RETÉN GOMA, BOMBA DE AGUA	RUBBER TUBE, WATER PUMP	TENUTA IN GOMMA, POMPA ACQUA	MANCHON CAOUTCHOUC DE POMPE À EAU
34	PAF4-03000020	6E0-44328-00	PLACA FIJACIÓN BOMBA DE AGUA	PLATE, WATER PUMP FIXED	PLACCA DI FISSAGGIO POMPA ACQUA	PLAQUE FIXATION DE POMPE À EAU
35	PAF4-03000005	90467-08M01	CLIP	CLIP	CLIP	CLIP
36	PAF4-03000016	93604-09066	PIN	PIN, DOWEL	SPINOTTO	PIN
37	REC6E0-45511-01	6E0-45511-01	EJE VERTICAL S	SHAFT, DRIVE S	ASSE VERTICALE S	ARBRE VERTICAL S
	REC6E0-45511-11	6E0-45511-11	EJE VERTICAL L	SHAFT, DRIVE L	ASSE VERTICALE L	ARBRE VERTICAL L





2T 6HP/C/MSH/CMH/CWH/MBK'07/D/DMH/DWH  
STROKES 8HP/C/MSH/MH/CMH/CWH

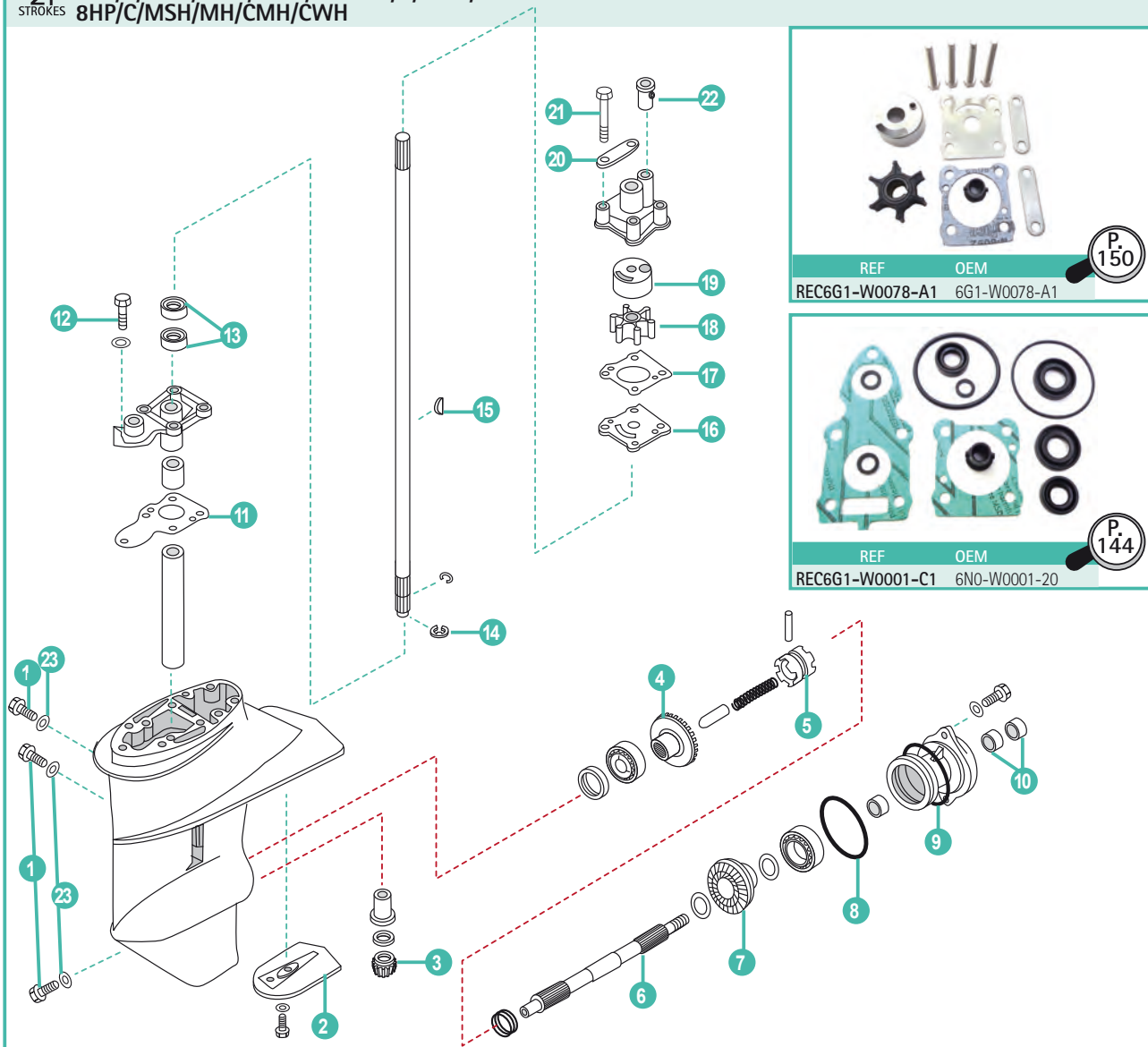

	REF	OEM				
1	REC90340-08002	6E0-45316-09	TAPÓN	PLUG	TAPPO	BOUCHON REMPLISSAGE D'HUILE
2	TEN01118	6N0-G5251-00	ÁNODO	ANODE	ANODO	ANODE
3	REC6N0-G5551-00	6N0-G5551-00	PIÑÓN ATAQUE	INITIATIVE GEAR	MARCIA INIZIATIVA	PIGNON D'ATTAQUE
4	REC6N0-G5560-00	6N0-G5560-00	PIÑÓN MARCHA AVANTE	POSITIVE GEAR ASSY	PIGNONE MARCIA AVANTI	PIGNON DE MARCHÉ AVANT
5	REC6G1-45631-00	6G1-45631-00	EMBRAGUE DE GARRA	CLUTCH, DOG	SELETTORE	CRABOT
6	REC6G1-45611-01	6G1-45611-01	EJE HÉLICE	SHAFT, PROPELLER	ASSE ELICA	ARBRE D'HELICE
7	REC6N0-G5571-00	6N0-G5571-00	PIÑÓN MARCHA ATRÁS	REVERSE GEAR	PIGNONE MARCIA INDIETRO	PIGNON MARCHÉ ARRIÈRE
8	REC93210-49046	93210-49046	ARO TÓRICO	O-RING	O-RING	JOINT TORIQUE
9	REC93210-53M08	93210-53M08	ARO TÓRICO	O-RING	O-RING	JOINT TORIQUE
10	REC93101-15074	93101-15074	RETÉN	OIL SEAL	PARAOLIO	JOINT SPI
11	REC6G1-45315-A0	6G1-45315-A0	JUNTA	PACKING, LOWER CASING	GUARNIZIONE	JOINT
12	PAGB/T5783-M6X30	97095-06030	TORNILLO	BOLT	VITE	VIS
13	REC93101-11M23	93101-11M23	RETÉN	OIL SEAL	PARAOLIO	JOINT SPI
14	REC99001-06600	99001-06600	CERCLIP	CIRCLIP	CIRCLIP	CIRCLIP
15	REC90280-03024	90280-03024	CHAVETA	KEY	CHIAVETTA	CLAVETTE
16	REC6G1-44323-00	6G1-44323-00	PLATO	OUTTER PLATE, CARTRIDGE	PIASTRA	PLAQUE DE POMPE À EAU
17	REC6G1-44315-A0	6G1-44315-A0	JUNTA	GASKET, WATER PUMP	GUARNIZIONE	JOINT
18	REC6G1-44352-00	6G1-44352-00	TURBINA	IMPELLER	GIRANTE	TURBINE
19	REC6G1-44322-00	6G1-44322-00	CASQUILLO	INSERT, CARTRIDGE	GHIERA	INSERT DE POMPE À EAU
20	REC6G1-44328-00	6G1-44328-00	PLACA FIJACIÓN BOMBA DE AGUA	PLATE, WATER PUMP FIXED	PLACCA DI FISSAGGIO POMPA ACQUA	PLAQUE FIXATION DE POMPE À EAU
21	REC97095-06045	97095-06045	TORNILLO	BOLT	VITE	VIS
22	REC647-44366-00	647-44366-00	CASQUILLO GOMA	DAMPER	GHIERA GOMA	BAGUE CAOUTCHOUC
23	REC90430-08020	90430-08020	JUNTA	GASKET	GUARNIZIONE	JOINT

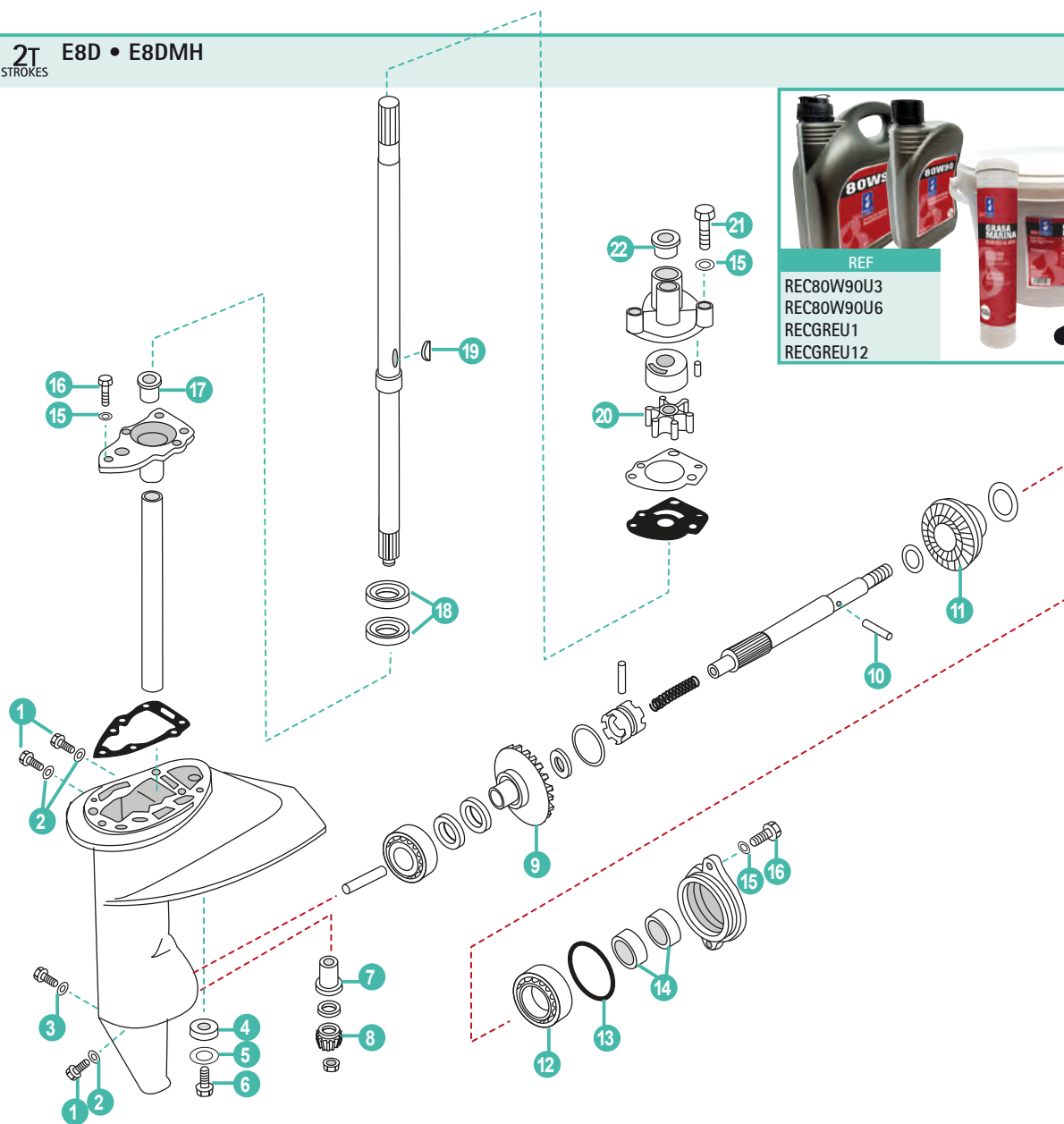

	REF	OEM				
1	REC90340-08002	90340-08M04	TORNILLO	BOLT	VITE	VIS
2	REC90430-08020	90430-08020	JUNTA	GASKET	GUARNIZIONE	JOINT
3	REC90430-06M03	90430-06M03	JUNTA	GASKET	GUARNIZIONE	JOINT
4	CM6E0-45251-11	677-45251-00	ÁNODO	ANODE	ANODO	ANODE
5	PAGB/T861.1-87	92990-06300	ARANDELA	WASHER	RONDELLA	RONDELLE
6	PAGB/T5783-M6X35	95895-06012	TORNILLO	BOLT	VITE	VIS
7	REC647-45316-09	647-45316-09	CASQUILLO	DAMPER	GHIERA GOMA	PIN
8	REC647-45551-00	647-45551-00	PIÑÓN ATAQUE	INITIATIVE GEAR	MARCIA INIZIATIVA	PIGNON D'ATTAQUE
9	REC647-45560-00	647-45560-00	PIÑÓN MARCHA AVANTE	POSITIVE GEAR ASSY	PIGNONE MARCIA AVANTI	PIGNON DE MARCHÉ AVANT
10	REC90250-05036	90250-05036	PASADOR	PIN	SPINOTTO	PIN
11	REC647-45570-00	647-45570-01	PIÑÓN MARCHA ATRÁS	REVERSE GEAR	PIGNONE MARCIA INDIETRO	PIGNON MARCHÉ ARRIÈRE
12	REC93306-00519	93306-00519	COJINETE	BEARING	CUSCINETTO	ROULEMENT
13	REC93210-58677	93210-58677	ARO	O-RING	O-RING	JOINT TORIQUE
14	REC93101-15074	93101-15074	RETÉN ACEITE	OIL SEAL	PARAOLIO	JOINT SPI
15	PAGB/T97.1-6	92990-06600	ARANDELA	WASHER	RONDELLA	RONDELLE
16	PAGB/T5783-M6X20	97095-06020	PERNO	BOLT	VITE	VIS
17	REC647-45316-09	647-45316-09	CASQUILLO	BUSH	GHIERA	BAGUE
18	REC93101-18050	93101-18050	RETÉN ACEITE	OIL SEAL	PARAOLIO	JOINT SPI
19	REC90280-03024	90280-03024	CHAVETA	KEY	CHIAVETTA	CLAVETTE
20	REC662-44352-01	662-44352-01	IMPULSOR	IMPELLER	GIRANTE	TURBINE
21	REC97095-06040	97095-06040	PERNO	BOLT	VITE	VIS
22	REC647-44366-00	647-44366-00	GOMA	RUBER BAND	GOMMA	BAGUE

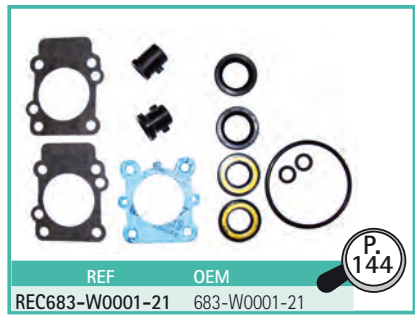
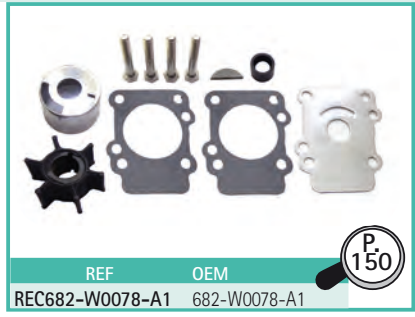
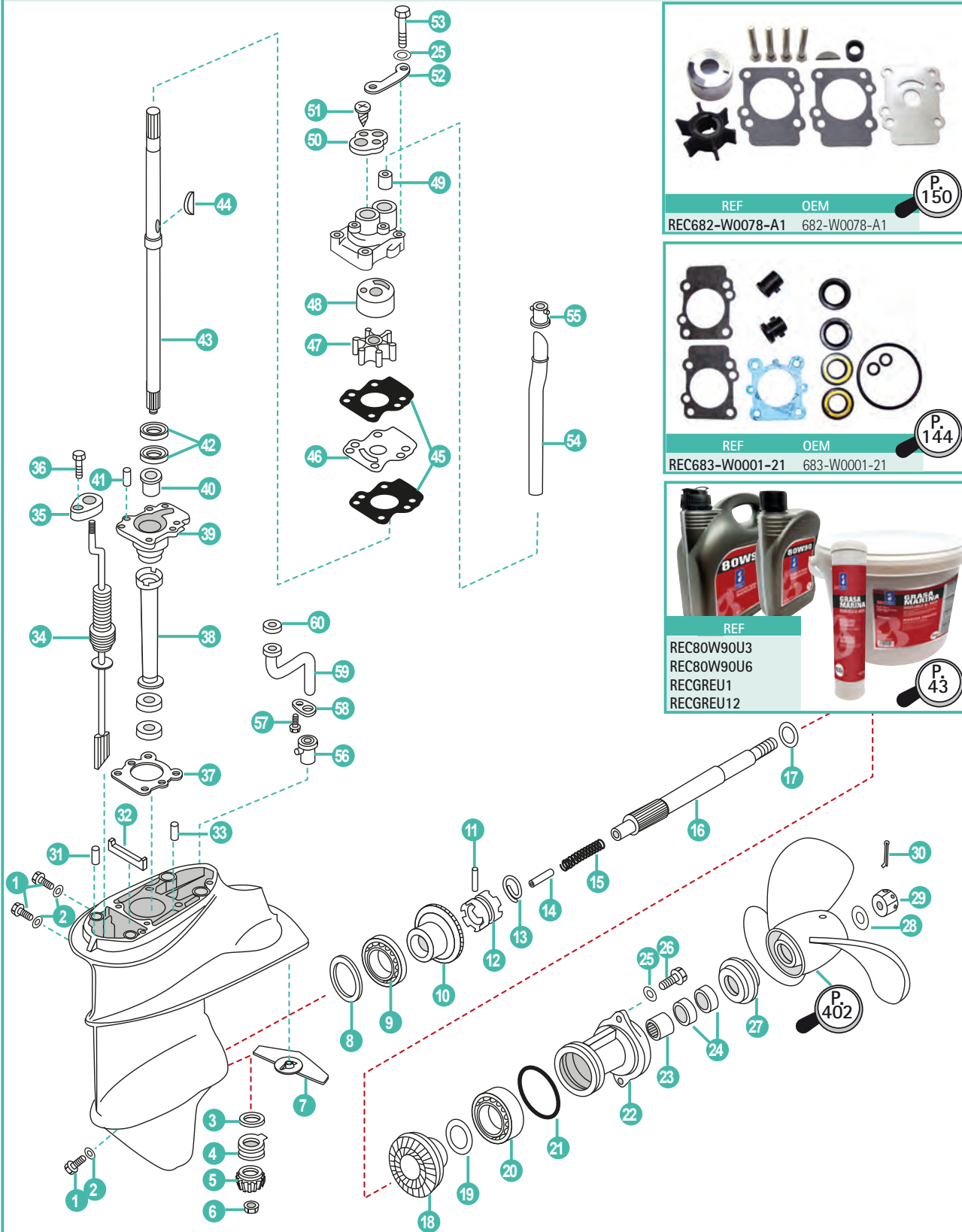

	REF	OEM				
1	REC90340-08002	90340-08014	TAPÓN	PLUG, STRAIGHT SCREW	TAPPO	BOUCHON DE VIDANGE
2	REC90430-08020	90430-08020	JUNTA	GASKET	GUARNIZIONE	JOINT
3	PAF15-06000009	6E7-45587-01-30	GRUESO (1.20mm)	SHIM (1.20mm)	SPESSORE (1.20mm)	CALE (1.20 mm)
4	REC93341-214U1	93341-214U1	RODAMIENTO	BEARING	CUSCINETTO	ROULEMENT
5	REC6E7-45551-00	6E7-45551-00	PIÑÓN ATAQUE	INITIATIVE GEAR	MARCIA INIZIATIVA	PIGNON D'ATTAQUE
6	REC90179-08M06	90179-08M06	TUERCA	NUT	DADO	ÉCROU
7	TEN01116	6B4-45251-00	ÁNODO	ANODE	ANODO	ANODE

	REF	OEM				
8	PAF15-06000010-1	664-45567-05	GRUESO (0.05mm)	SHIM (0.05mm)	SPESSORE (0.05mm)	CALE (0.05 mm)
	PAF15-06000010-2	664-45567-12	GRUESO (0.12mm)	SHIM (0.12mm)	SPESSORE (0.12mm)	CALE (0.12 mm)
	PAF15-06000010-5	664-45567-30	GRUESO (0.30mm)	SHIM (0.30mm)	SPESSORE (0.30mm)	CALE (0.30 mm)
	PAF15-06000010-7	664-4556-50	GRUESO (0.50mm)	SHIM (0.50mm)	SPESSORE (0.50mm)	CALE (0.50 mm)
9	REC93332-00005	93332-00005	RODAMIENTO	BEARING	CUSCINETTO	ROULEMENT
10	REC6E7-45560-01	6E7-45560-00	PIÑÓN MARCHA AVANTE	POSITIVE GEAR ASSY	PIGNONE MARCIA AVANTI	PIGNON DE MARCHE AVANT
11	REC90250-05010	90250-05010	PASADOR	PIN, STRAIGHT	SPINOTTO	PIN
12	REC682-45631-00	682-45631-00	EMBRAGUE DE GARRA	CLUTCH, DOG	SELETTORE	CRABOT
13	REC648-45633-00	648-45633-00	ANILLO	RING, CROSS PIN	O-RING	JOINT TORIQUE
14	REC650-45635-00	650-45635-00	PISTÓN	PLUNGER, SHIFT	PISTONE	PISTON
15	PAF15-06070002	90501-14M06	MUELLE	SPRING, COMPRESSION	MOLLA	RESSORT
16	REC683-45611-00	683-45611-00	EJE HÉLICE	SHAFT, PROPELLER	ASSE ELICA	ARBRE D'HELICE
17	REC90201-17682	90201-17682	ARANDELA	WASHER, PLATE	RONDELLA	RONDELLE
18	REC6E7-45570-00	6E7-45571-00	PIÑÓN MARCHA ATRÁS	REVERSE GEAR	PIGNONE MARCIA INDIETRO	PIGNON MARCHE ARRIÈRE
19	PAF15-06080006-1	626-45577-00-01	GRUESO (0.10mm)	SHIM (0.10mm)	SPESSORE (0.10mm)	CALE (0.10 mm)
	PAF15-06080006-3	626-45577-00-03	GRUESO (0.30mm)	SHIM (0.30mm)	SPESSORE (0.30mm)	CALE (0.30 mm)
	PAF15-06080006-5	626-45577-00-05	GRUESO (0.50mm)	SHIM (0.50mm)	SPESSORE (0.50mm)	CALE (0.50 mm)
20	REC93306-00501	93306-00501	RODAMIENTO	BEARING	CUSCINETTO	ROULEMENT
21	REC93210-57M09	93210-57M09	ARO TÓRICO	O-RING	O-RING	JOINT TORIQUE
22	REC683-45361-01-4D	683-45361-00-EJ	DIÁBOLO	CAP, LOWER CASING	COP. CASSA INGRANAGGI	DIABOLO
23	REC93315-317U2	93315-317U2	RODAMIENTO	BEARING	CUSCINETTO	ROULEMENT
24	REC93101-17054	93101-17054	RETÉN	OIL SEAL	PARAOLIO	JOINT SPI
25	PAGB/T97.1-16	92990-06600	ARANDELA	WASHER, PLATE	RONDELLA	RONDELLE
26	PAGB/T5783-M6X20	97395-06020	TORNILLO	BOLT	VITE	VIS
27	REC6E7-45987-00	6E7-45987-00	ESPACIADOR	SPACER	DISTANZIALE	ENTRETOISE
28	PAGB/T96-10	90201-10M01	SEPARADOR	SPACER	DISTANZIALE	CALE
29	PAF15-06000016	90171-10M01	TUERCA HÉLICE	NUT, CASTLE	DADO ELICA	ÉCROU
30	PAGB/T91-2.5X20	91490-30020	PASADOR ALETAS	PIN, COTTER	PIN ELICA	CLAVETTE
31	REC93606-12019	93606-12019	PIN	PIN	SPINOTTO	PIN
32	REC682-45376-01	682-45376-01	GUÍA RETÉN	GUIDE, SEAL DAMPER	GUIDA BOCCOLA	GUIDE
33	PAF25-04000007	93604-08062	PIN	PIN, DOWEL	SPINOTTO	PIN
34	REC682-44147-00	682-44147-00	TAPÓN GUÍA	BOOT, SHIFT ROD	TAPPO GUIDA	GUIDE
35	REC682-44176-00	682-44176-00	SOPORTE	BRACKET	SUPPORTO	SUPPORT
36	PAGB/T845-ST4.8X9	97780-50510	TORNILLO	SCREW	VITE	VIS
37	REC683-45315-A0	683-45315-00	JUNTA	PACKING, LOWER CASING	GUARNIZIONE	JOINT
38	REC6E7-45536-00	6E7-45536-00	CAMISA EJE	SLEEVE, DRIVE SHAFT	TUBO GUIDA	TUBE GUIDE
39	REC6E7-45331-00-CA	6E7-45331-00-9M	CUERPO DE RODAMIENTO	HOUSING, BEARING	CUSCINETTO	LOGEMENT
40	REC626-45316-09	626-45316-09	CASQUILLO	BUSHING, DRIVE SHAFT	GHIERA	BAGUE
41	REC93606-12019	93606-12019	PIN	PIN, DOWEL	SPINOTTO	PIN
42	REC93101-20048	93101-20048	RETÉN	OIL SEAL	PARAOLIO	JOINT SPI
43	REC6E7-45501-00	6E7-45501-00	EJE S	DRIVE SHAFT COMP. S	ASSE VERTICALE S	ARBRE VERTICAL S
	REC6E7-45501-11	6E7-45501-10	EJE L	DRIVE SHAFT COMP. L	ASSE VERTICALE L	ARBRE VERTICAL L
44	REC90280-03024	90280-03024	CHAVETA	KEY, WOODRUFF	CHIAVETTA	CLAVETTE
45	REC682-44315-00	682-44315-00	JUNTA	GASKET, WATER PUMP	GUARNIZIONE	JOINT
46	REC682-44323-40	682-44323-00	PLATO	OUTER PLATE, CARTRIDGE	PIASTRA	PLAQUE DE POMPE À EAU
47	REC682-44352-01	682-44352-00	TURBINA	IMPELLER	GIRANTE	TURBINE
48	REC682-44322-00	682-44322-00	CASQUILLO INOX.	INSERT, CARTRIDGE	GHIERA INOX.	INSERT DE POMPE À EAU
49	REC682-44365-00	682-44365-00	CASQUILLO GOMA	DAMPER, WATER SEAL	GHIERA GOMA	BAGUE
50	REC682-44312-00	682-44312-00	TAPA CUERPO BOMBA AGUA	COVER, WATER PUMP HOUSING	COPERCHIO CORPO ACQUA	CORPS DE POMPE À EAU
51	PAGB/T845-ST4.2X16	97780-40112	TORNILLO	SCREW, TAPPING	VITE	VIS
52	REC682-44328-00	682-44328-00	PLATO	PLATE	PIASTRA	PLAQUE
53	PAGB/T5782-M6X45	947395-06040	TORNILLO	BOLT	VITE	VIS
54	REC682-44361-01	682-44361-01	TUBO DE AGUA S	WATER TUBE S	TUBO ACQUA S	TUBE D'EAU S
	REC682-44361-10	682-44361-10	TUBO DE AGUA L	WATER TUBE L	TUBO ACQUA L	TUBE D'EAU L
55	REC626-44365-01	626-44365-01	RETÉN	SEAL	PARAOLIO	JOINT SPI
56	REC6E7-44366-00	6E7-44366-00	CASQUILLO GOMA	WATER SEAL	BOCCOLA GOMMA	GUIDE CAOUTCHOUC
57	PAGB/T5783-M6X10	97095-06010	TORNILLO	BOLT	VITE	VIS
58	REC683-44373-00	683-44373-00	PLACA FIJACION TUBO	PLATE WATER TUBE	PLACCA SUPPORTO TUBO	PLAQUE DE FIXATION DE TUBE
59	REC683-44362-01	683-44361-01	TUBO DE AGUA	WATER TUBE "B"	TUBO ACQUA	TUBE D'EAU
60	REC683-44365-01	683-44365-01	CASQUILLO GOMA	SEAL WATER TUBE	BOCCOLA GOMMA	GUIDE CAOUTCHOUC



2T  
STROKES

9.9C/F/FMH/MSH/MH/MHH • 13.5AMH • 15FE/FMH/F/MSH/MH • E15C

YAMAHA

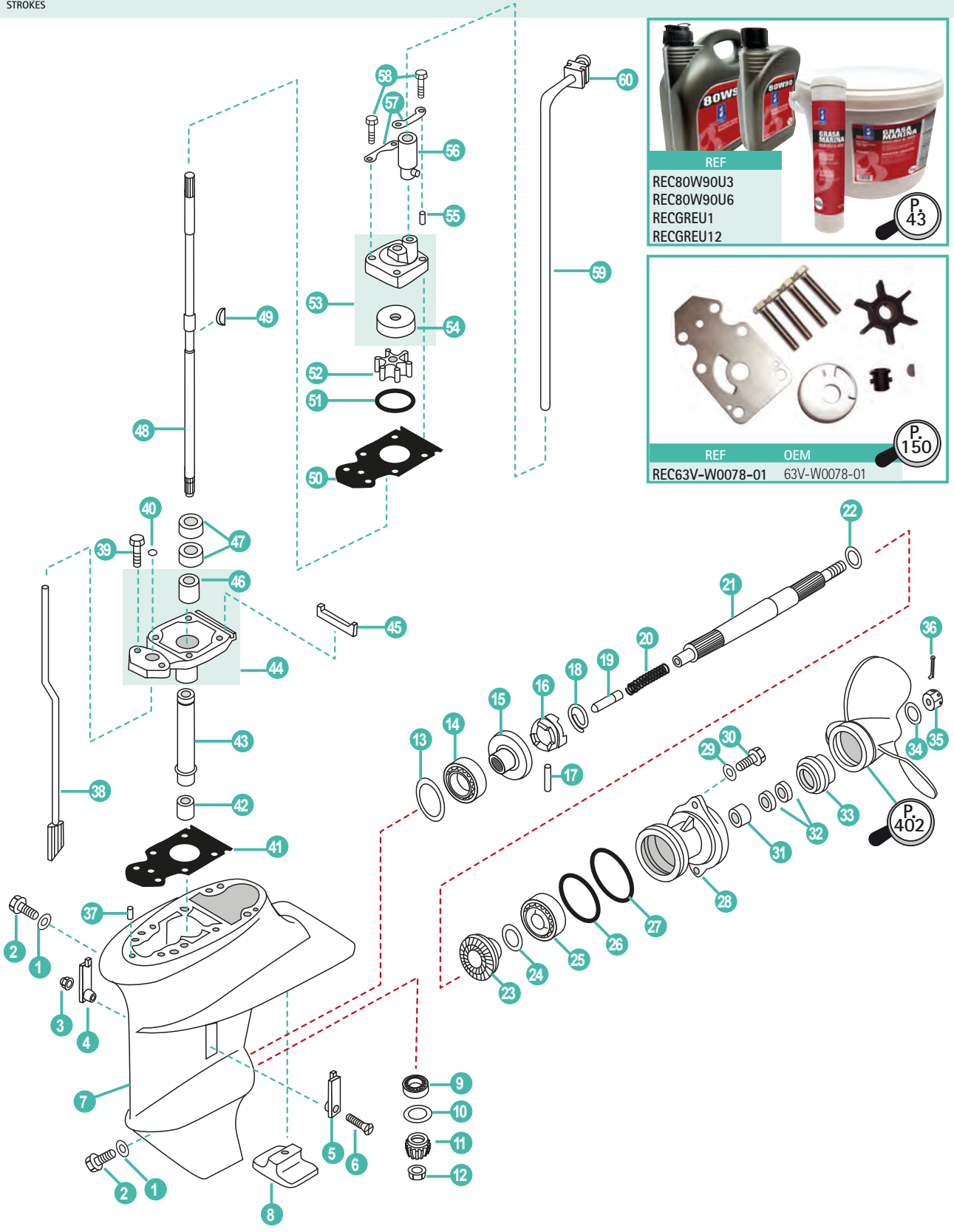

REF  
 REC80W90U3  
 REC80W90U6  
 RECGREU1  
 RECGREU12

P 43

REF OEM  
 REC63V-W0078-01 63V-W0078-01

P 150

	REF	OEM				
1	REC90430-08020	90430-08020	ARANDELA	WASHER	RONDELLA	RONDELLE
2	REC90340-08002	90340-08002	TAPÓN ACEITE	PLUG, OIL	TAPPO OLIO	BOUCHON REMPLISSAGE D'HUILE
3	PAGB/T6182-M5	90185-05002	TUERCA	LOCK NUT	DADO	ÉCROU
4	PAF15-06000002	63V-45215-00	CUBIERTA ENTRADA AGUA A	WATER INLET A	COPERCHIO ACQUA A	GRILLE D'ENTREE D'EAU A
5	PAF15-06000003	6G1-45214-00	CUBIERTA ENTRADA AGUA B	WATER INLET B	COPERCHIO ACQUA B	GRILLE D'ENTREE D'EAU B
6	PAGB/T820-M5X25	90152-05M04	TORNILLO	SCREW	VITE	VIS

RECAMBIOS MARINOS

	REF	OEM				
7	PAF15-06000001	63V-45311-01-4D CARTER	CASTING, LOWER	CARTER	CARTER	CARTER D'EMBASE
8	CM61N-45251-01	61N-45251-01 ÁNODO	ANODE	ANODO	ANODO	ANODE
9	REC93341-41414	93341-41414 RODAMIENTO	BEARING	CUSCINETTO	ROULEMENT	ROULEMENT
10	PAF15-06000008	6E8-45587-10-13 GRUESO (1.13 mm)	SHIM (1.13mm)	SPESSORE (1.13 mm)	CALE (1.13 mm)	CALE (1.13 mm)
11	REC63V-45551-00	63V-45551-00 PIÑÓN ATAQUE	INITIATIVE GEAR	MARCIA INIZIATIVA	PIGNON D'ATTAQUE	PIGNON D'ATTAQUE
12	REC90179-08M06	90179-08M06 TUERCA	LOCK NUT	DADO	ÉCROU	ÉCROU
13	PAF15-06000010-1	664-45567-01-10 GRUESO	SHIM	SPESSORE	CALE	CALE
14	REC93332-00005	93332-00005 COJINETE	BEARING	CUSCINETTO	ROULEMENT	ROULEMENT
15	REC6E7-45560-01	6E7-45560-01 PIÑÓN MARCHA AVANTE	POSITIVE GEAR ASSY	PIGNONE MARCIA AVANTI	PIGNON DE MARCHÉ AVANT	PIGNON DE MARCHÉ AVANT
16	REC682-45631-00	682-45631-00 SELECTOR	CLUTCH BLOCK	SELETTORE	CRABOT	CRABOT
17	REC90250-05010	90250-05010 PASADOR	PIN	SPINOTTO	PIN	PIN
18	REC648-45633-00	648-45633-00 MUELLE SELECTOR	RING, CROSS PIN	MOLLA SELETTORE	RESSORT	RESSORT
19	REC650-45635-00	650-45635-00 ÉMBOLO	PLUNGER	BULLONE	PISTON	PISTON
20	PAF15-06070002	90501-14M06 MUELLE	SPRING	MOLLA	RESSORT	RESSORT
21	REC683-45611-00	683-45611-00 EJE HÉLICE	PROPELLER SHAFT	ASSE ELICA	ARBRE D'HELICE	ARBRE D'HELICE
22	REC90201-17682	90201-17682 ARANDELA	WASHER	RONDELLA	RONDELLE	RONDELLE
23	REC6E7-45570-00	6E7-45571-00 PIÑÓN MARCHA ATRÁS	REVERSE GEAR	PIGNONE MARCIA INDIETRO	PIGNON MARCHÉ ARRIÈRE	PIGNON MARCHÉ ARRIÈRE
24	PAF15-06080006-1	626-45577-00 GRUESO	SHIM	SPESSORE	CALE	CALE
25	REC93306-00501	93306-00501 RODAMIENTO	BEARING (B6005)	CUSCINETTO	ROULEMENT	ROULEMENT
26	REC93210-57M09	93210-57M09 TÓRICA	O-RING	O-RING	JOINT TORIQUE	JOINT TORIQUE
27	PAF15-06080003	93210-56M80 TÓRICA	O-RING	O-RING	JOINT TORIQUE	JOINT TORIQUE
28	REC683-45361-01-4D	683-45361-02-4D DIÁBOLO	CAP, LOWER CASING	COPERCHIO CARTER INFERIORE	DIABOLO	DIABOLO
29	PAGB/T97.1-6	92995-06600 ARANDELA	WASHER	RONDELLA	RONDELLE	RONDELLE
30	PAGB/T5783-M6X20	97095-06020 TORNILLO	SCREW	VITE	VIS	VIS
31	REC93315-317U2	93315-317U2 COJINETE	BEARING	CUSCINETTO	ROULEMENT	ROULEMENT
32	REC93101-17054	93101-17054 RETÉN DE ACEITE	OIL SEAL	PARAOLIO	JOINT SPI	JOINT SPI
33	PAF15-06000015	6E7-45987-01 ESPACIADOR	SPACER	DISTANZIALE	ENTRETOISE	ENTRETOISE
34	REC6E7-45987-00	6E7-45987-01 SEPARADOR	SPACER	DISTANZIALE	ENTRETOISE	ENTRETOISE
35	REC90171-10M01	90171-10M01 TUERCA HÉLICE	NUT, CASTLE	DADO ELICA	ÉCROU	ÉCROU
36	REC91490-30025	91490-30020 PASADOR ALETAS	PIN, COTTER	PIN ELICA	CLAVETTE	CLAVETTE
37	PAF15-00000013	93604-10M03 PIN	PIN	SPINOTTO	PIN	PIN
38	PAF15-06030000S	63V-44150-00 EJE SELECTOR S	SHIFT CAM ASSY S	ASSE SELETTORE S	ARBRE SELECTEUR S	ARBRE SELECTEUR S
	PAF15-06030000L	63V-44150-10 EJE SELECTOR L	SHIFT CAM ASSY L	ASSE SELETTORE L	ARBRE SELECTEUR L	ARBRE SELECTEUR L
39	PAGB/T5783-M8X25	97080-08025 TORNILLO	SCREW	VITE	VIS	VIS
40	REC93210-06ME6	93210-06ME6 TÓRICA	O-RING	O-RING	JOINT TORIQUE	JOINT TORIQUE
41	REC63V-45315-AO	63V-45315-AO JUNTA	GASKET	GUANIZIONE	JOINT	JOINT
42	REC93315-314V8	93315-314V8 COJINETE	BEARING	CUSCINETTO	PALIER	PALIER
43	PAF15-06000006	63V-45536-00 TUBO GUÍA	SLEEVE, DRIVE SHAFT	TUBO GUIDA	TUBE	TUBE
44	REC63V-45331-00-5B	63V-45331-00-5B CUERPO DEL COJINETE	SHELL, BEARING	CORPO DE CUSCINETTO	LOGEMENT DE PALIER	LOGEMENT DE PALIER
45	PAF15-06020005	63V-45375-00 GOMA	SEAL	GOMMA	TAMPON	TAMPON
46	REC626-45316-09	90381-14020 CASQUILLO	BUSH, SOLID	BOCCOLA	BAGUE	BAGUE
47	REC93101-20048	93101-20048 RETÉN DE ACEITE	OIL SEAL	PARAOLIO	JOINT SPI	JOINT SPI
48	REC63V-45510-01	63V-45510-01 EJE VERTICAL S	DRIVE SHAFT ASSY S	ASSE VERTICALE S	ARBRE VERTICAL S	ARBRE VERTICAL S
	REC63V-45510-11	63V-45510-11 EJE VERTICAL L	DRIVE SHAFT ASSY L	ASSE VERTICALE L	ARBRE VERTICAL L	ARBRE VERTICAL L
49	REC664-44338-00	63V-44338-00 CHAVETA	KEY, WOODRUFF	CHIAVETTA	CLAVETTE	CLAVETTE
50	REC63V-44323-00	63V-44323-00 JUNTA TAPA BOMBA AGUA	GASKET, WATER PUMP COVER	GUARNIZIONE COPERCHIO	JOINT COUVERCLE	JOINT COUVERCLE
51	PAJASOF404-31-045	93210-44398 ARO TÓRICO	O-RING	O-RING	JOINT TORIQUE	JOINT TORIQUE
52	REC63V-44352-01	63V-44352-01 TURBINA	IMPELLER	GIRANTE	TURBINE	TURBINE
53	REC63V-44301-00	63V-44301-00 CUERPO DE BOMBA	PUMP HOUSING	CORPO POMPA	CORPS DE POMPE À EAU	CORPS DE POMPE À EAU
54	REC63V-44322-00	63V-44322-00 TAPA, BOMBA AGUA	COVER, INNER WATER PUMP	COPERCHIO, POMPE ACQUA	INSERT DE POMPE À EAU	INSERT DE POMPE À EAU
55	PAF15-00000013	93604-12M07 PASADOR	PIN	SPINOTTO	PIN	PIN
56	REC647-44366-00	647-44366-00 TUBO GOMA BOMBA AGUA	RUBBER TUBE, WATER PUMP	TUBO IN GOMMA, POMPA	DURITE DE COUTCHOU	DURITE DE COUTCHOU
57	PAF15-06000014	63V-44328-00 PLACA	OUT PLATE	PIASTRA	PLAQUE	PLAQUE
58	REC97080-08045	97080-08045 PERNO	STUD	BULLONE	BOULON	BOULON
59	REC63V-44361-01	63V-44361-01 TUBO DE AGUA S	WATER TUBE S	TUBO DELL'ACQUA S	DURITE D'EAU S	DURITE D'EAU S
	REC63V-44361-11	63V-44361-11 TUBO DE AGUA L	WATER TUBE L	TUBO DELL'ACQUA L	DURITE D'EAU L	DURITE D'EAU L
60	PAF15-02000006	63V-44365-10 GOMA DEL TUBO DE AGUA	I-SHAPED RUBBER BAND	GOMMA TUBO ACQUA	PLOT CAOUTCHOU	PLOT CAOUTCHOU DE TUBE D'EAU

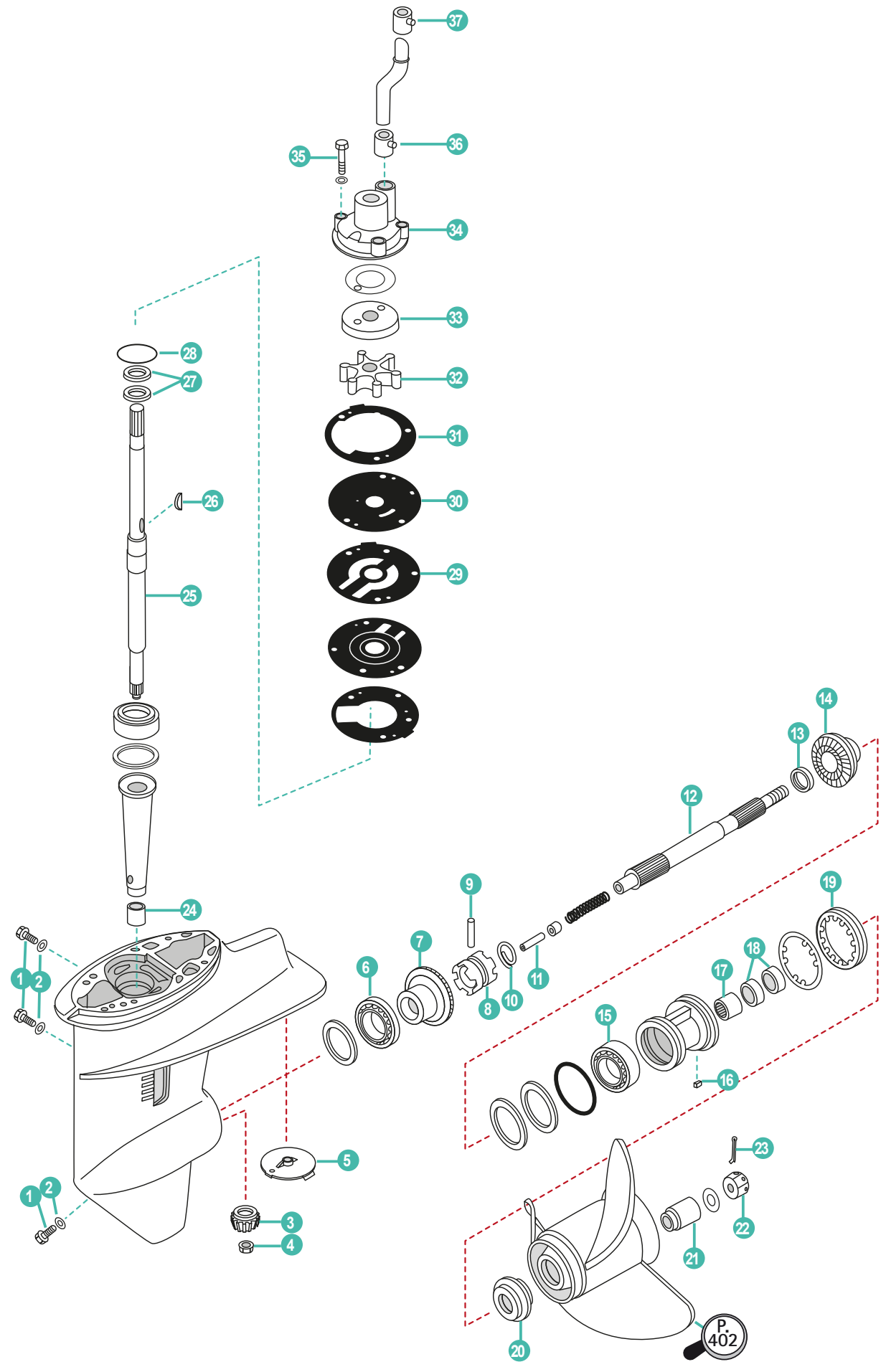

	REF	OEM				
1	REC90340-08002	90340-08002	TAPÓN ACEITE	PLUG, OIL	TAPPO OLIO	BOUCHON REMPLISSAGE D'HUILE
2	REC90430-08020	90430-08020	ARANDELA	WASHER	RONDELLA	RONDELLE
3	REC689-45551-00	689-45551-00	PIÑÓN ATAQUE	INITIATIVE GEAR	MARCIA INIZIATIVA	PIGNON D'ATTAQUE
4	REC90179-09M02	90179-09M02	TUERCA, PIÑÓN	NUT	DADO	ÉCROU
5	CM664-45371-01	664-45371-01-00	ÁNODO	ANODE	ANODO	ANODE
6	REC93332-00005	93332-00005	COJINETE	BEARING	CUSCINETTO	ROULEMENT
7	REC689-45560-00	689-45560-00	PIÑÓN MARCHA AVANTE	POSITIVE GEAR ASSY	PIGNONE MARCIA AVANTI	PIGNON DE MARCHÉ AVANT
8	REC664-45631-01	664-45631-01	SELECTOR	CLUTCH	SELETTORE	CRABOT
9	REC90250-05010	90250-05010	PASADOR	PIN	SPINOTTO	LEVIER
10	REC648-45633-00	648-45633-00	ARO, PASADOR	CROSS PIN	O-RING	JOINT TORIQUE
11	REC648-45635-00	648-45635-00	PIVOTE	PIN	PERNO	ARBRE
12	REC689-45611-00	689-45611-00	EJE HÉLICE	SHAFT PROPELLER	ASSE ELICA	ARBRE D'HELICE
13	REC90201-20417	90201-20417	ARANDELA	WASHER	RONDELLA	RONDELLE
14	REC689-45571-00-00	689-45570-00	PIÑÓN MARCHA ATRÁS	REVERSE GEAR	PIGNONE MARCIA INDIETRO	PIGNON MARCHÉ ARRIÈRE
15	REC93306-00612	93306-00612	COJINETE	BEARING	CUSCINETTO	ROULEMENT
16	REC90282-04010	90282-04010	CHAVETA	KEY	CHIAVETTA	CLAVETTE
17	REC93315-22004	93315-22004	COJINETE	BEARING	CUSCINETTO	ROULEMENT
18	REC93101-20M07	93101-20M07	RETÉN	OIL SEAL	PARAOLIO	JOINT D'HUILE
19	REC664-45384-00	664-45384-00	TUERCA	NUT	DADO	ÉCROU
20	REC664-45987-00	664-45987-00	ESPACIADOR	SPACER	DISTANZIALE	CALE
21	REC689-45997-00	689-45997-00	ESPACIADOR	SAPCER	DISTANZIALE	CALE
22	REC90171-14013-00	90171-14013	TUERCA HÉLICE	NUT	DADO	ÉCROU
23	REC91490-30030	91490-30030	PASADOR	COTTER PIN	PIN	PIN
24	REC93315-017U4	93315-017U4	COJINETE, PIÑÓN	BEARING	CUSCINETTO	ROULEMENT
25	REC689-45501-10	689-45501-10	EJE L	DRIVE SHAFT L	ASSE VERTICALE L	ARBRE VERTICAL L
26	REC664-44338-00	664-44338-00	CUÑA	CHAVETA	KEY	CHIAVETTA
27	REC93101-22067	93101-22067	RETÉN ACEITE	OIL SEAL	PARAOLIO	JOINT SPI
28	REC689-44315-A0	689-44315-A0	JUNTA BASE	GASKET	GUARNIZIONE	JOINT
29	REC689-44316-A0	689-44316-A0	JUNTA BASE	GASKET	GUARNIZIONE	JOINT
30	REC689-44323-00	689-44323-03	CHAPA	PLATE	PIASTRA	PLAQUE
31	REC689-44324-A0	689-44324-A0	JUNTA, CHAPA	GASKET	GUARNIZIONE	JOINT
32	REC689-44352-02	689-44352-02	IMPULSOR	IMPELLER	GIRANTE	TURBINE
33	REC689-W4432-01	689-W4432-02	ACOPLE	INSERT CUP	ACCOPPIAMENTO	INSERT DE POMPE À EAU
34	REC689-44311-00	689-44311-03	CUERPO BOMBA AGUA	HOUSING W.P.	CORPO POMPA ACQUA	CORPS DE POMPE
35	REC90101-06M56	90101-06M56	TORNILLO CUERPO BOMBA	BOLT	VITE	VIS
36	REC626-44365-01	626-44365-01	RETÉN SUPERIOR TUBO DE AGUA	DUMPER WATER TUBE	PARAOLIO SUPERIORE TUBO ACQUA	BAGUE TUBE D'EAU
37	REC689-44366-00	689-44366-00	RETÉN SUPERIOR TUBO DE AGUA	DUMPER WATER TUBE	PARAOLIO SUPERIORE TUBO ACQUA	BAGUE TUBE D'EAU

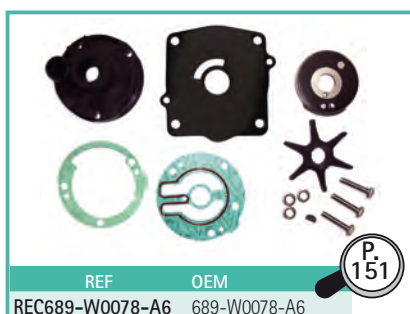



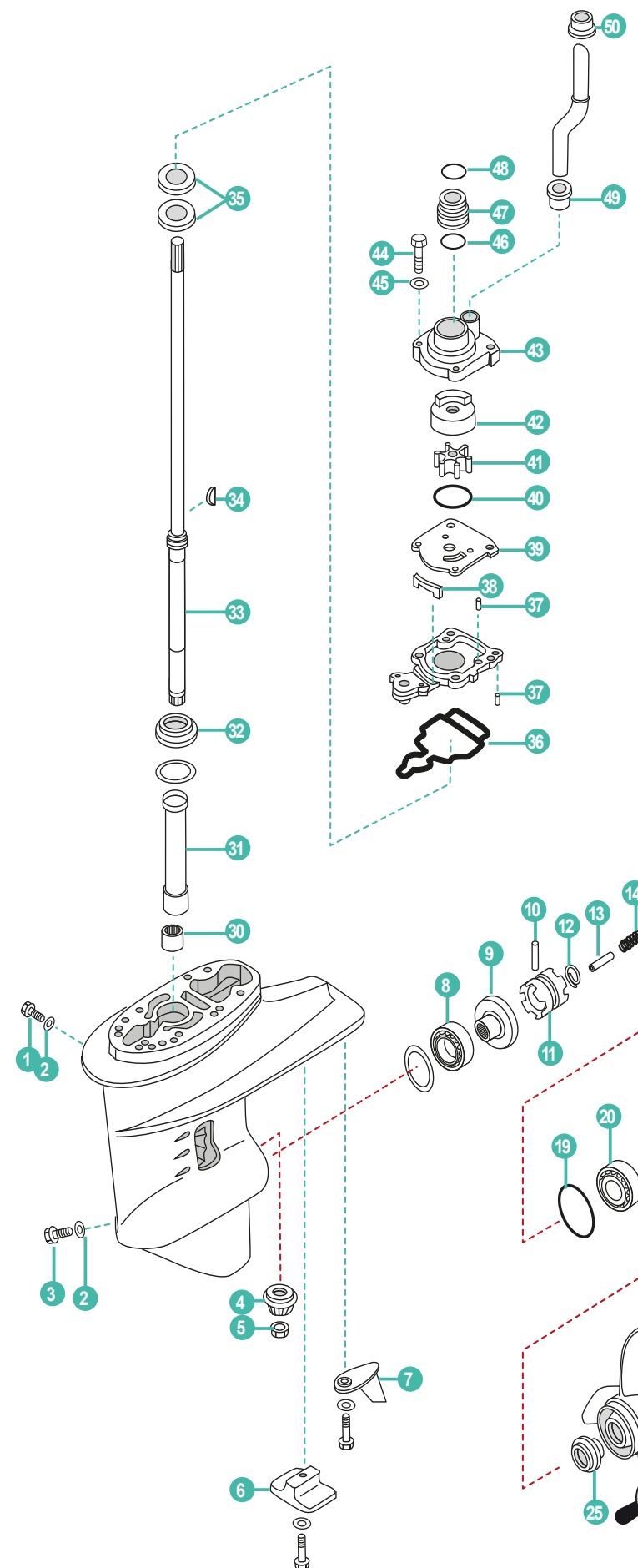

REF	OEM
REC61N-W0001-E1	61N-W0001-E1

REF	OEM
REC61N-W0078-11	61N-W0078-11

REF
REC80W90U3
REC80W90U6
RECGREU1
RECGREU12

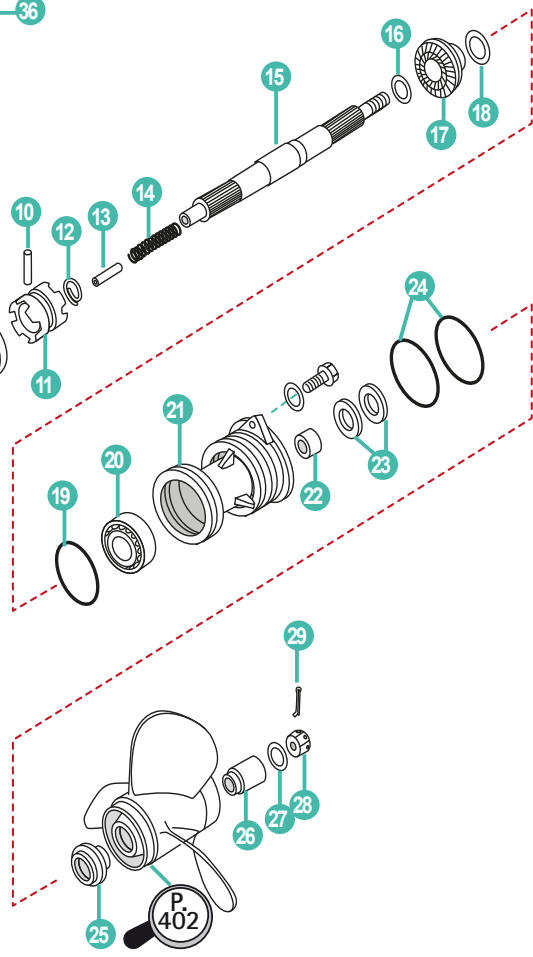

	REF	OEM				
1	REC90340-08002	90340-08002	TAPÓN	PLUG, STRAIGHT SCREW	TAPPO	BOUCHON
2	REC90430-08020	90430-08020	JUNTA	GASKET	GUARNIZIONE	JOINT
3	REC688-45341-00	688-45341-10	TAPÓN VACIADO	PLUG, DRAIN	TAPPO	BOUCHON
4	REC61N-45551-00	61N-45551-00	PIÑÓN ATAQUE	INITIATIVE GEAR	MARCIA INIZIATIVA	PIGNON D'ATTAQUE
5	REC90179-10M14	90179-10M14	TUERCA	NUT	DADO	ÉCROU
6	CM61N-45251-01	61N-45251-01	ÁNODO	ANODE	ANODO	ANODE
7	TEN01130	61N-45371-00	ÁNODO ZINC	TAB-TRIM	ANODO ZINCO	ANODE
8	REC93332-00005	93332-00005	RODAMIENTO	BEARING	CUSCINETTO	ROULEMENT
9	REC61N-45560-10	61N-45560-10	PIÑÓN MARCHA AVANTE	POSITIVE GEAR ASSY	PIGNONE MARCIA AVANTI	PIGNON DE MARCHÉ AVANT
10	REC90250-05010	90250-05010	PASADOR	PIN, STRAIGHT	SPINOTTO	PIN
11	REC664-45631-00	664-45631-02	DEAPLAZABLE	CLUTCH, DOG	SCORREVOLE	CRABOT
12	REC648-45633-00	648-45633-00	MUELLE	RING, CROSS PIN	MOLLA	RESSORT
13	REC648-45635-00	648-45635-00	BULÓN	PLUNGER, SHIFT	BULLONE	BOULON
14	PAF25-04060002	90501-10065	MUELLE COMPRESIÓN	SPRING, COMPRESSION	MOLLA	RESSORT
15	REC6L2-45611-00	6L2-45611-00	EJE HÉLICE	SHAFT, PROPELLER	ASSE ELICA	ARBRE D'HELICE
16	REC90201-20417	90201-20417	ARANDELA	WASHER, PLATE	RONDELLA	RONDELLE
17	REC61N-45571-00	61N-45571-00	PIÑÓN MARCHA ATRÁS	REVERSE GEAR	PIGNONE MARCIA INDIETRO	PIGNON MARCHE ARRIÈRE
18	PAF25-04070005-1	6L2-45577-00-10	GRUESO (1.0 mm)	SHIM (t:1.0mm)	SPESSORE (1.0 mm)	CALE (1.0 mm)
19	REC93210-64ME7	93210-64ME7	ARO TÓRICO	O-RING	O-RING	JOIN TORIQUE
20	REC93306-00612	93306-00612	RODAMIENTO	BEARING	CUSCINETTO	ROULEMENT
21	PAF25-04070001	61N-45361-01-4D	DIÁBOLO	CAP, LOWER CASING	COP. CASSA INGRANAGGI	DIABOLO
22	REC93315-22004	93315-22004	RODAMIENTO	BEARING	CUSCINETTO	ROULEMENT
23	REC93101-20M07	93101-20M07	RETÉN	OIL SEAL	PARAOLIO	JOINT SPI
24	REC93210-65M50	93210-65M50	ARO TÓRICO	O-RING	O-RING	JOINT TORIQUE
25	REC6L2-45987-00	6L2-45987-01	SEPARADOR	SPACER	DISTANZIALE	CALE
26	REC689-45997-00	689-45997-00	SEPARADOR	SPACER	DISTANZIALE	CALE
27	PAGB/T97.1-14	92990-14200	ARANDELA	WASHER, PLAIN	RONDELLA	RONDELLE
28	REC90171-14013-00	90171-14013	TUERCA	NUT, CASTLE	DADO	ÉCROU
29	PAGB/T91-1.6x12	91490-30022	PASADOR	PIN	SPINOTTO	PIN
30	REC93315-220V7	93315-220V7	RODAMIENTO	BEARING	CUSCINETTO	ROULEMENT
31	PAF25-04000002	61N-45536-00	TUBO GUÍA	SLEEVE, DRIVE SHAFT	TUBO GUIDA	TUBE GUIDE
32	REC93332-000W5	93332-000WS	RODAMIENTO	BEARING	CUSCINETTO	ROULEMENT
33	REC61N-45510-00	61N-45510-00	EJE VERTICAL S	DRIVE SHAFT ASSY S	ASSE VERTICALE S	ARBRE VERTICAL S
	REC61N-45510-10	61N-45510-10	EJE VERTICAL L	DRIVE SHAFT ASSY L	ASSE VERTICALE L	ARBRE VERTICAL L
34	REC90280-03M03	90280-03M03	CHAVETA	KEY, WOODRUFF	CHIAVETTA	CLAVETTE
35	REC93101-22067	93101-22067	RETÉN	OIL SEAL	PARAOLIO	JOINT SPI
36	PAF25-04000009	61N-45315-00	JUNTA	PACKING, LOWER CASING	GUARNIZIONE	JOINT
37	PAF25-04000007	93604-10M03	PIN CENTRADO	PIN, DOWEL	SPINOTTO	PIN
38	PAF25-04000013	61N-45127-00	RETÉN	SEAL	PARAOLIO	JOINT SPI
39	REC61N-44323-00	61N-44323-00	PLATO BOMBA AGUA	OUTTER PLATE, CARTRIDGE	PIASTRA POMPA ACQUA	PLAQUE
40	PAF25-04050003	93210-45161	ARO TÓRICO	O-RING	O-RING	JOINT TORIQUE
41	REC6H4-44352-02	6H4-44352-02	TURBINA	IMPELLER	GIRANTE	TURBINE
42	REC61N-44322-00	61N-44322-01	CASQUILLO INOX.	INSERT, CARTRIDGE	BOCCOLA INOX.	INSERT DE POMPE À EAU
43	PAF25-04050001	61N-44311-01	CUERPO BOMBA	HOUSING, WATER PUMP	CORPO POMPA	CORPS DE POMPE À EAU
44	REC97095-06040	97095-06040	TORNILLO	BOLT	VITE	VIS
45	PAGB/T97.1-6	92995-06600	ARANDELA	WASHER	RONDELLA	RONDELLE
46	PAGB/T3452.1-25.8X2	93210-26130	ARO TÓRICO	O-RING	O-RING	JOINT TORIQUE
47	PAF25-04000017S	61N-44362-00	TUBO AGUA S	WATER TUBE S	TUBO ACQUA S	TUBE D'EAU S
	PAF25-04000017	61N-44362-10	TUBO AGUA L	WATER TUBE L	TUBO ACQUA L	TUBE D'EAU L
48	PAGB/T3452.1-25.8X2	93210-22164	ARO TÓRICO	O-RING	O-RING	JOINT TORIQUE
49	PAF25-04050004	6L2-44367-00	CASQUILLO	DAMPER WATER PIPE	BOCCOLA	BAGUE TUBE D'EAU
50	REC689-44366-00	689-44366-00	CASQUILLO	DAMPER, WATER SEAL	BOCCOLA	BAGUE TUBE D'EAU

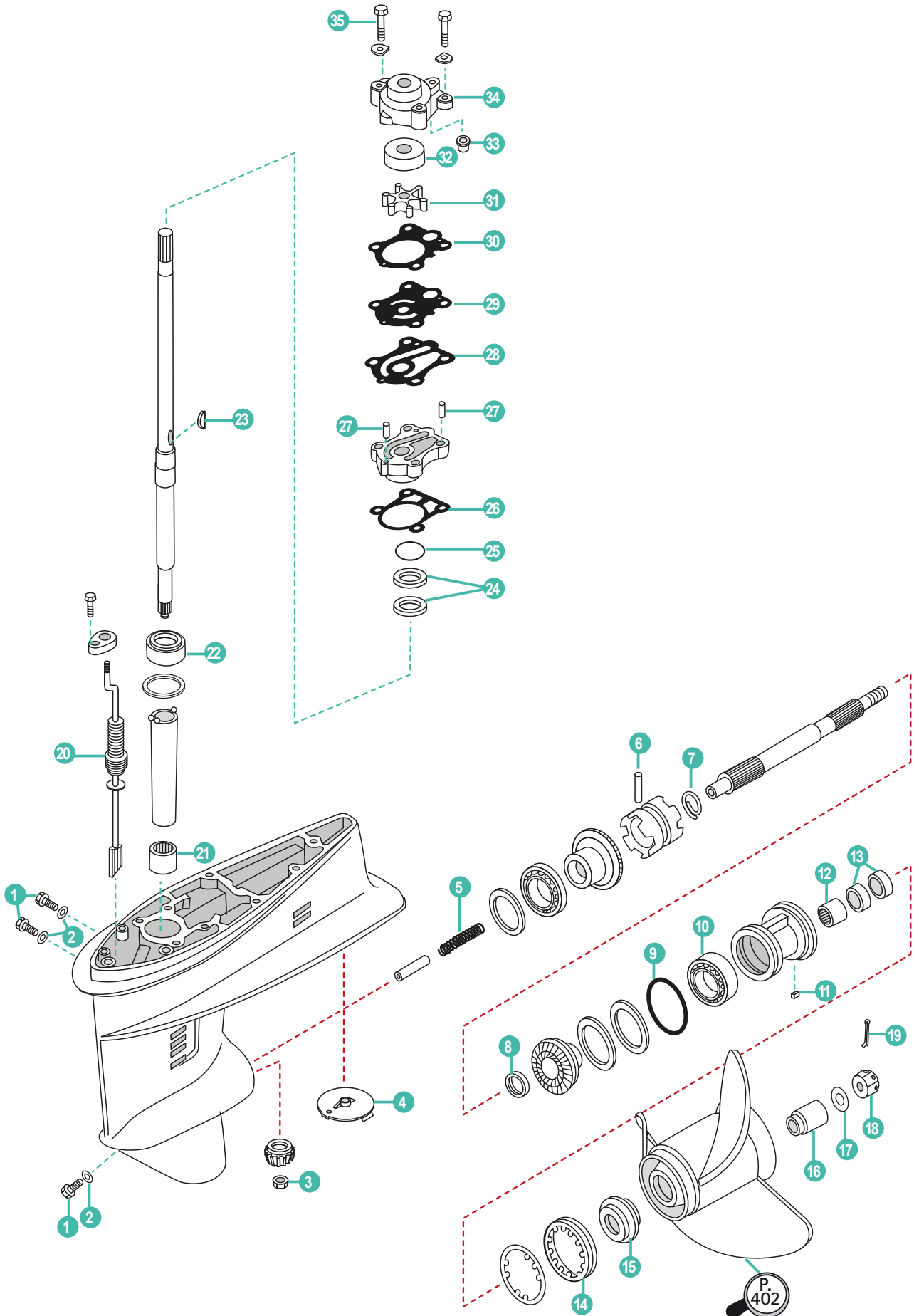

	REF	OEM				
1	REC90340-08002	90340-08002	TAPÓN	PLUG, STRAIGHT SCREW	TAPPO	BOUCHON DE VIDANGE
2	REC90430-08020	90430-08020	JUNTA	GASKET	GUARNIZIONE	JOINT
3	REC90179-10M14	90179-10M14	TUERCA	NUT	DADO	ECROU
4	CM664-45371-01	664-45371-01	ÁNODO DERIVA	TAB-TRIM	ANODO	ANODE
5	PAF25-04060002	90501-10065	MUELLE	SPRING, COMPRESSION	MOLLA	RESSORT
6	REC90250-05010	90250-05010	PASADOR	PIN, STRAIGHT	SPINOTTO	PIN
7	REC648-45633-00	648-45633-00	ARO	RING CROSS PIN	O-RING	JOINT TORIQUE
8	REC90201-20417	90201-20417	ARANDELA	WASHER, PLATE	RONDELLA	RONDELLE
9	REC93210-60MA3	93210-60MA3	ARO TÓRICO	O-RING	O-RING	JOINT TORIQUE
10	REC93306-00612	93306-00612	RODAMIENTO	BEARING	CUSCINETTO	ROULEMENT
11	REC90282-04010	90282-04010	CHAVETA	KEY, STRAIGHT	CHIAVETTA	CLAVETTE
12	REC93315-22004	93315-22004	RODAMIENTO	BEARING	CUSCINETTO	ROULEMENT
13	REC93101-20M07	93101-20M07	RETÉN	OIL SEAL	PARAOLIO	JOINT SPI
14	REC664-45384-00	664-45384-00	TUERCA	NUT	DADO	EROU
15	REC6L2-45987-00	6L2-45987-01	DISTANCIADOR	SPACER	DISTANZIALE	ENTRETOISE
16	REC689-45997-00	689-45997-00	DISTANCIADOR	SPACER	DISTANZIALE	ENTRETOISE
17	PAGB/T97.1-14	92990-14200	ARANDELA	WASHER, PLAIN	RONDELLA	RONDELLE
18	REC90171-14013-00	90171-14013	TUERCA HÉLICE	NUT, CASTLE	DADO	ECROU D'HELICE
19	REC91490-30025	91490-30025	PIN	PIN	SPINOTTO	CLAVETTE
20	REC682-44147-00	682-44147-00	TAPÓN GUÍA	BOOT, SHIFT ROD	TAPPO	GUIDE
21	REC93315-220V7	93315-220V7	RODAMIENTO	BEARING	CUSCINETTO	ROULEMENT
22	REC93332-00001	93332-00001	RODAMIENTO	BEARING	CUSCINETTO	ROULEMENT
23	REC90280-03024	90280-03024	CHAVETA	KEY, WOODRUFF	CHIAVETTA	CLAVETTE
24	REC93101-23070	93101-23070	RETÉN	OIL SEAL	PARAOLIO	JOINT SPI
25	REC93210-41042	93210-41042	ARO TÓRICO	O-RING	O-RING	JOINT TORIQUE
26	REC663-44316-A0	663-44316-A0	JUNTA	GASKET, WATER PUMP	GUARNIZIONE	JOINT
27	REC663-44324-00	663-44324-A0	JUNTA	GASKET, CARTRIDGE	GUARNIZIONE	JOINT
28	PAF25-04000007	93604-08062	PIN	PIN	SPINOTTO	PIN
29	REC663-44323-00	663-44323-00	PLATO BOMBA AGUA	OUTTER PLATE	PIASTRA POMPA ACQUA	PLAQUE DE POMPE À EAU
30	REC663-44315-A0	663-44315-A0	JUNTA	GASKET, WATER PUMP	GUARNIZIONE	JOINT
31	REC6H4-44352-02	6H4-44352-02	TURBINA	IMPELLER	GIRANTE	TURBINE
32	REC663-44322-00	663-44322-00	CASQUILLO INOX	INSERT, CARTRIDGE	BOCCOLA INOX.	INSERT DE POMPE À EAU
33	REC663-44366-00	663-44366-00	CASQUILLO GOMA	DAMPER, WATER SEAL	BOCOLLA GOMMA	BAGUE
34	REC663-44311-02	6J8-44311-00	CUERPO BOMBA AGUA	HOUSING, WATER	CORPO POMPA ACQUA	CORPS DE POMPE À EAU
35	REC90119-08M13	90119-08M13	TORNILLO	BOLT, WITH WASHER	VITE	VIS

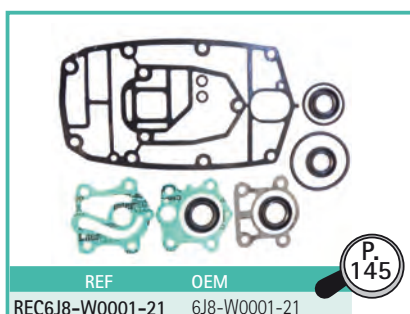



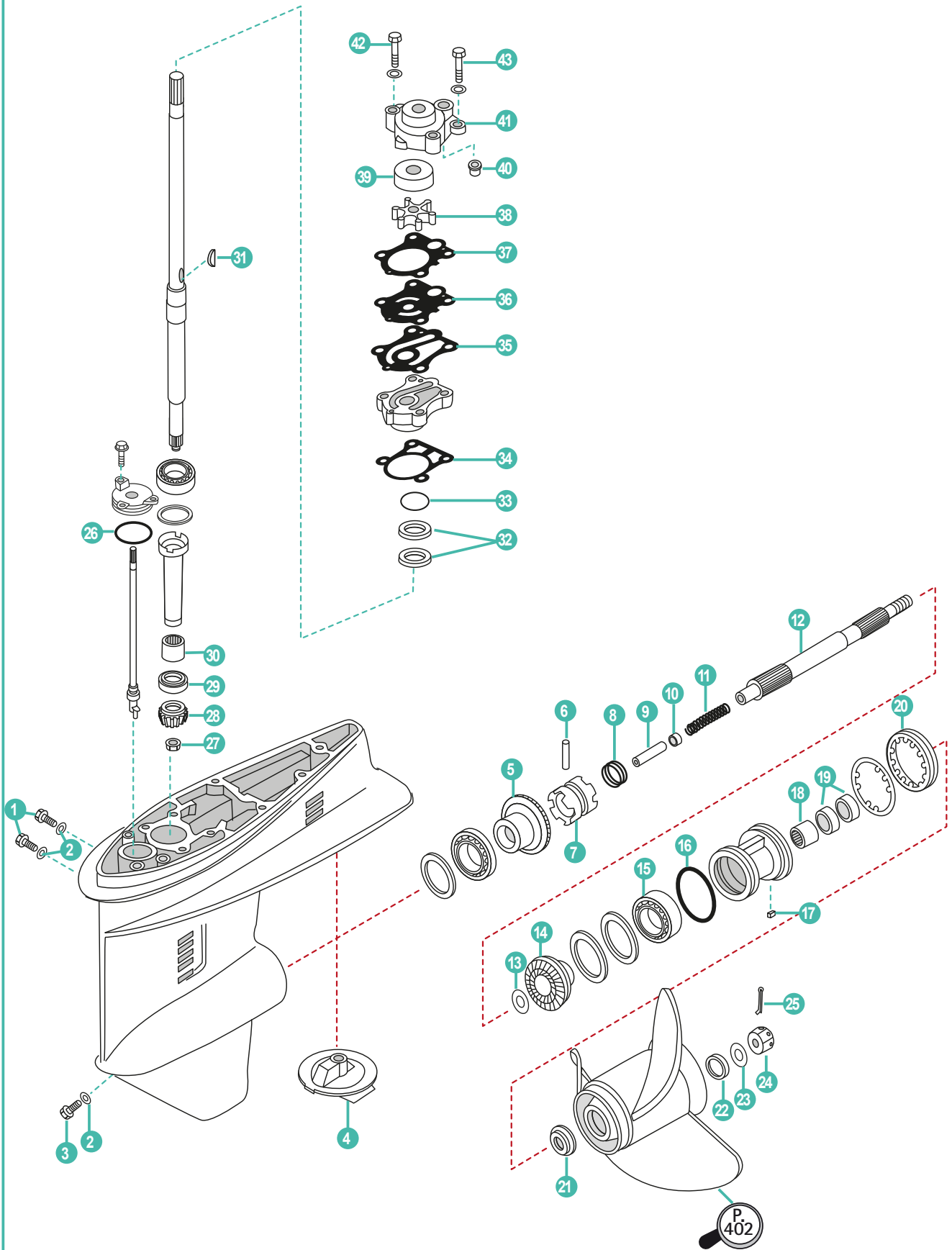

	REF	OEM				
1	REC90340-08002	90340-08014	TORNILLO	BOLT	VITE	VIS
2	REC90430-08020	90430-08020	JUNTA	GASKET	GUARNIZIONE	JOINT
3	REC688-45341-00	688-45341-00	TAPÓN DRENAJE	PLUG	TAPPO	BOUCHON DE VIDANGE
4	CM664-45371-01	664-45371-01	ÁNODO	ANODE	ANODO	ANODE
5	REC6H4-45560-00	6H4-45560-00	PIÑÓN MARCHA AVANTE	POSITIVE GEAR ASSY	PIGNONE MARCIA AVANTI	PIGNON DE MARCHÉ AVANT
6	REC90250-06023	90250-06023	PASADOR	PIN	SPINOTTO	PIN
7	REC663-45631-00	663-45631-01	DESPLAZABLE	CLUTCH	SCORREVOLE	CRABOT
8	REC663-45633-00	663-45633-00	ARO	SPING	O-RING	JOINT TORIQUE
9	REC676-45635-00	676-45635-00	PIVOTE	PIN	SPINOTTO	PIVOT
10	REC663-45634-00	663-45634-00	CASQUILLO	SLIDE	BOCCOLA	DOUILLE
11	REC90501-16M01	90501-16M01	MUELLE	SPRING	MOLLA	RESSORT
12	REC679-45611-00	679-45611-01	EJE HÉLICE	SHAFT PROPELLER	ASSE ELICA	ARBRE D'HELICE
13	REC90201-22429	90201-22429	ARANDELA	WASHER	RONDELLA	RONDELLE
14	REC6H4-45570-00	6H4-45571-00	PIÑÓN MARCHA ATRÁS	REVERSE GEAR	PIGNONE MARCIA INDIETRO	PIGNON MARCHÉ ARRIÈRE
15	REC93306-00702	93306-00702	RODAMIENTO BOLAS	BEARING	CUSCINETTO	ROULEMENT
16	REC93210-66M98	93210-66M98	ARO	O-RING	O-RING	JOINT TORIQUE
17	REC90282-04010	90282-04010	CHAVETA	KEY	CHIAVETTA	CLAVETTE
18	REC93317-22204	93317-22204	COJINETE AGUJAS	CILINDRIC BEARING	CUSCINETTO	ROULEMENT
19	REC93101-22067	93101-22067	RETÉN ACEITE	OIL SEAL	PARAOLIO	JOINT SPI
20	REC697-45384-00	697-45384-00	TUERCA	NUT	DADO	ÉCROU
21	REC663-45987-00	663-45987-02	ESPACIADOR	SPACER	DISTANZIALE	ENTRETOISE
22	REC670-45997-00	670-45997-02	ESPACIADOR	SPACER	DISTANZIALE	ENTRETOISE
23	REC92990-16200	92990-16200	ARANDELA	WASHER	RONDELLA	RONDELLE
24	REC90171-16011	90171-16011	TUERCA	NUT	DADO	ÉCROU D'HELICE
25	REC91490-30030	91490-30030	PASADOR	PIN COTTER	SPINOTTO	CLAVETTE
26	REC93210-49046	93210-49046	ARO PLATO	O-RING	O-RING	JOINT TORIQUE
27	REC90170-12138	90170-12138	TUERCA	NUT	DADO	ÉCROU
28	REC6H4-45551-00	6H4-45551-00	PIÑÓN ATAQUE	INITIATIVE GEAR	MARCIA INIZIATIVA	PIGNON D'ATTAQUE
29	REC663-45552-00	663-45552-00	COJINETE (-1998)	BEARING (-1998)	CUSCINETTO (-1998)	ROULEMENT (-1998)
30	REC93315-32224	93315-32224	RODAMIENTO AGUJAS	BEARING	CUSCINETTO	ROULEMENT
31	REC90280-03024	90280-03024	CHAVETA	KEY	CHIAVETTA	CLAVETTE
32	REC93101-23070	93101-23070	RETÉN ACEITE	OIL SEAL	PARAOLIO	JOINT SPI
33	REC93210-41042	93210-41042	ARO, BASE BOMBA	O-RING	O-RING	JOINT TORIQUE
34	REC663-44316-A0	663-44316-A0	JUNTA BASE	GASKET	GUARNIZIONE	JOINT
35	REC663-44324-A0	663-44324-A0	JUNTA	GASKET	GUARNIZIONE	JOINT
36	REC663-44323-00	663-44323-00	TAPA	OUTTER PLATE	TAPPO	PLAQUE DE POMPE À EAU
37	REC663-44315-A0	663-44315-A0	JUNTA	GASKET	GUARNIZIONE	JOINT
38	REC6H4-44352-02	6H4-44352-02	IMPULSOR	IMPELLER	GIRANTE	TURBINE
39	REC663-44322-00	663-44322-00	CASQUILLO	INSERT CARTRIDGE	BOCCOLA	INSERT DE POMPE À EAU
40	REC663-44366-00	663-44366-00	RETÉN	SEAL	TENUTA	JOINT SPI
41	REC663-44311-02	663-44311-02	CUERPO BOMBA AGUA	HOUSING WATER P.	CORPO POMPA ACQUA	CORPS DE POMPE À EAU
42	REC97095-08045	97395-08045	TORNILLO	BOLT	VITE	VIS
43	REC97095-08055	97395-08055	TORNILLO	BOLT	VITE	VIS

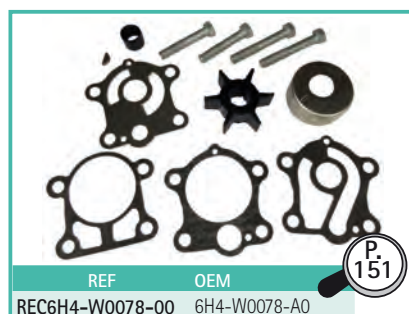
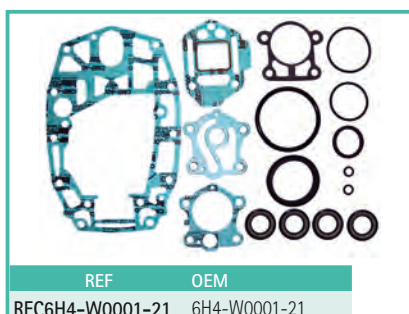

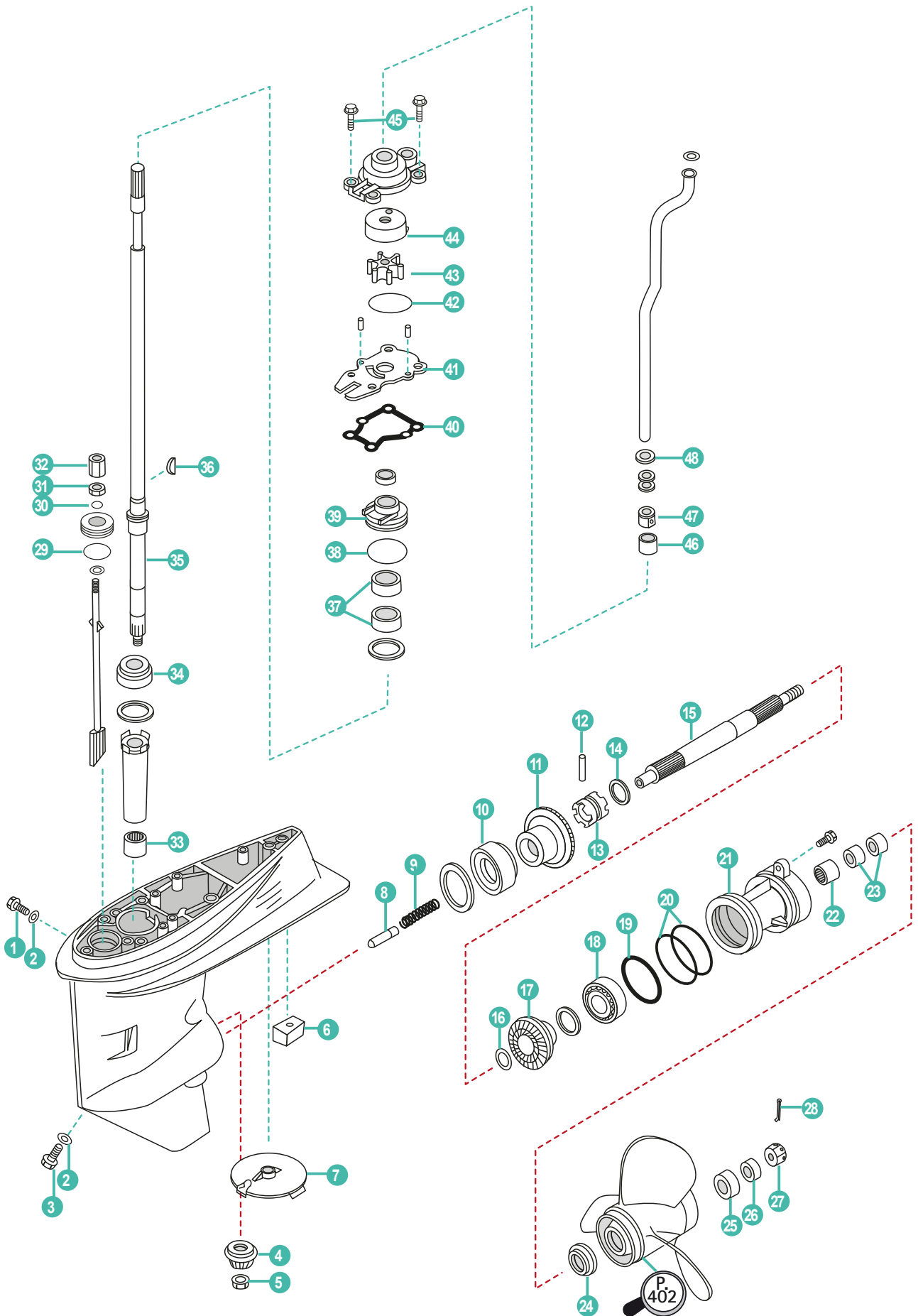

	REF	OEM				
1	REC90340-08002	90340-08002	TAPÓN	PLUG	TAPPO	BOUCHON DE VIDANGE
2	REC90430-08020	90430-08020	JUNTA	GASKET	GUARNIZIONE	JOINT
3	REC688-45341-00	688-45341-10	TAPÓN	PLUG	TAPPO	BOUCHON DE VIDANGE
4	REC66T-45551-00	66T-45551-00	PIÑÓN ATAQUE	INITIATIVE GEAR	MARCIA INIZIATIVA	PIGNON D'ATTAQUE
5	REC90170-12138	90170-12138	TUERCA	NUT	DADO	ECROU
6	CM67C-45251-00	67C-45251-00	ÁNODO	ANODE	ANODO	ANODE
7	CM664-45371-01	664-45371-01	ÁNODO DERIVA	TAB-TRIM	ANODO	ANODE
8	REC66T-45635-00	66T-45635-00	BULÓN	PLUNGER	BULLONE	BOULON
9	PAT40-04050002	90501-15M01	RESORTE	SPRING	MOLLA	RESSORT
10	REC93332-00003	93332-00003	RODAMIENTO	BEARING	CUSCINETTO	ROULEMENT
11	REC66T-45560-00	66T-45560-01	PIÑÓN MARCHA AVANTE	POSITIVE GEAR ASSY	PIGNONE MARCIA AVANTI	PIGNON DE MARCHÉ AVANT
12	REC90250-06023	90250-06023	PASADOR	PIN	SPINOTTO	PIN
13	REC66T-45631-00	66T-45631-00	SELECTOR	CLUTCH, DOG	SELETTORE	CRABOT
14	REC663-45633-00	663-45633-00	ANILLO	RING	O-RING	JOINT TORIQUE
15	REC66T-45611-00	66T-45611-00	EJE HÉLICE	SHAFT	ASSE ELICA	ARBRE D'HELICE
16	REC90201-22429	90201-22429	ARANDELA	WASHER	RONDELLA	RONDELLE
17	REC66T-45571-00	66T-45571-00	PIÑÓN MARCHA ATRÁS	REVERSE GEAR	PIGNONE MARCIA INDIETRO	PIGNON MARCHÉ ARRIÈRE
18	REC93306-001U1	93306-001U1	RODAMIENTO	BEARING	CUSCINETTO	ROULEMENT
19	REC93210-69MG6	93210-69MG6	ANILLO TÓRICO	O-RING	O-RING	JOINT TORIQUE
20	REC93210-74MG5	93210-74MG5	ANILLO TÓRICO	O-RING	O-RING	JOINT TORIQUE
21	REC63D-45361-02-4D	63D-45361-02-4D	DIÁVOLO	CAP	COP. CASSA INGRANAGGI	DIABOLO
22	REC93317-22204	93317-22204	RODAMIENTO	BEARING	CUSCINETTO	ROULEMENT
23	REC93101-22M00	93101-22M00	RETÉN	OIL SEAL	PARAOLIO	JOINT SPI
24	REC663-45987-00	663-45987-02	ESPACIADOR	SPACER	DISTANZIALE	ENTRETOISE
25	REC66T-45997-00	66T-45997-00	ESPACIADOR	SPACER	DISTANZIALE	ENTRETOISE
26	REC90389-22M01	90389-22M01	CASQUILLO GRUESO	BUSH	BOCCOLA	RONDELLE D 'HELICE
27	REC90171-16011	90171-16011	TUERCA HÉLICE	NUT, CASTLE	DADO	ECROU D'HELICE
28	REC91490-30025	91490-30025	PASADOR ALETAS	PIN	SPINOTTO	CLAVETTE
29	REC93210-33MG4	93210-33MG4	ARILLO TÓRICO	O-RING	O-RING	JOINT TORIQUE
30	REC93210-06ME6	93210-06ME6	ARILLO TÓRICO	O-RING	O-RING	JOINT TORIQUE
31	REC95380-06700	95380-06700	TUERCA	NUT	DADO	ECROU
32	REC61N-44146-00	61N-44146-00	CONECTOR	CONNECTOR	RACCORDO	CONNECTEUR
33	REC93315-32224	93315-32224	RODAMIENTO	BEARING	CUSCINETTO	ROULEMENT
34	REC93332-00001	93332-00001	RODAMIENTO	BEARING	CUSCINETTO	ROULEMENT
35	REC66T-45501-01	66T-45501-01	EJE VERTICAL S	DRIVE SHAFT ASSY S	ASSE VERTICALE S	ARBRE VERTICAL S
	REC66T-45501-10	66T-45501-11	EJE VERTICAL L	DRIVE SHAFT ASSY L	ASSE VERTICALE L	ARBRE VERTICAL L
36	REC90280-03M03	90280-03M03	CHAVETA	KEY	CHIAVETTA	CLAVETTE
37	REC93101-22M60	93101-22M60	RETÉN	OIL SEAL	PARAOLIO	JOINT SPI
38	REC93210-48MG8	93210-48MG8	ARILLO TÓRICO	O-RING	O-RING	JOINT TORIQUE
39	REC63D-44341-00	63D-44341-00	CUERPO	HOUSING	CORPO	LOGEMENT
40	REC63D-44316-00	63D-44316-00	JUNTA	GASKET, WATER PUMP	GUARNIZIONE	JOINT
41	REC66T-44323-00	66T-44323-00	PLATO	OUTTER PLATE	PIASTRA	PLAQUE DE POMPE À EAU
42	REC93210-59MG7	93210-59MG7	ARILLO TÓRICO	O-RING	O-RING	JOINT TORIQUE
43	REC6H4-44352-02	6H4-44352-02	TURBINA	IMPELLER	GIRANTE	TURBINE
44	REC63D-44322-00	63D-44322-00	CASQUILLO	INSERT	BOCCOLA	INSERT DE POMPE À EAU
45	REC90119-08M15	90119-08M15	TORNILLO	BOLT	VITE	BOULON
46	REC663-44366-00	663-44366-00	CASQUILLO	DAMPER	BOCCOLA	DOUILLE
47	REC63D-44312-00	63D-44312-00	TAPA	COVER	COPERCHIO	BAGUE
48	REC90430-12072	90430-12072	JUNTA	GASKET	GUARNIZIONE	JOINT

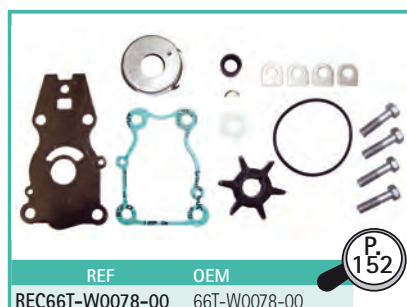
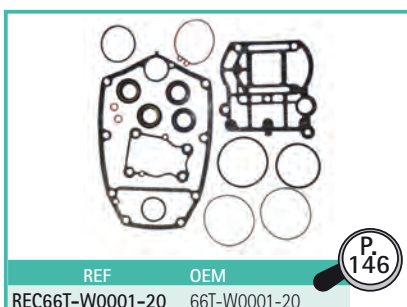



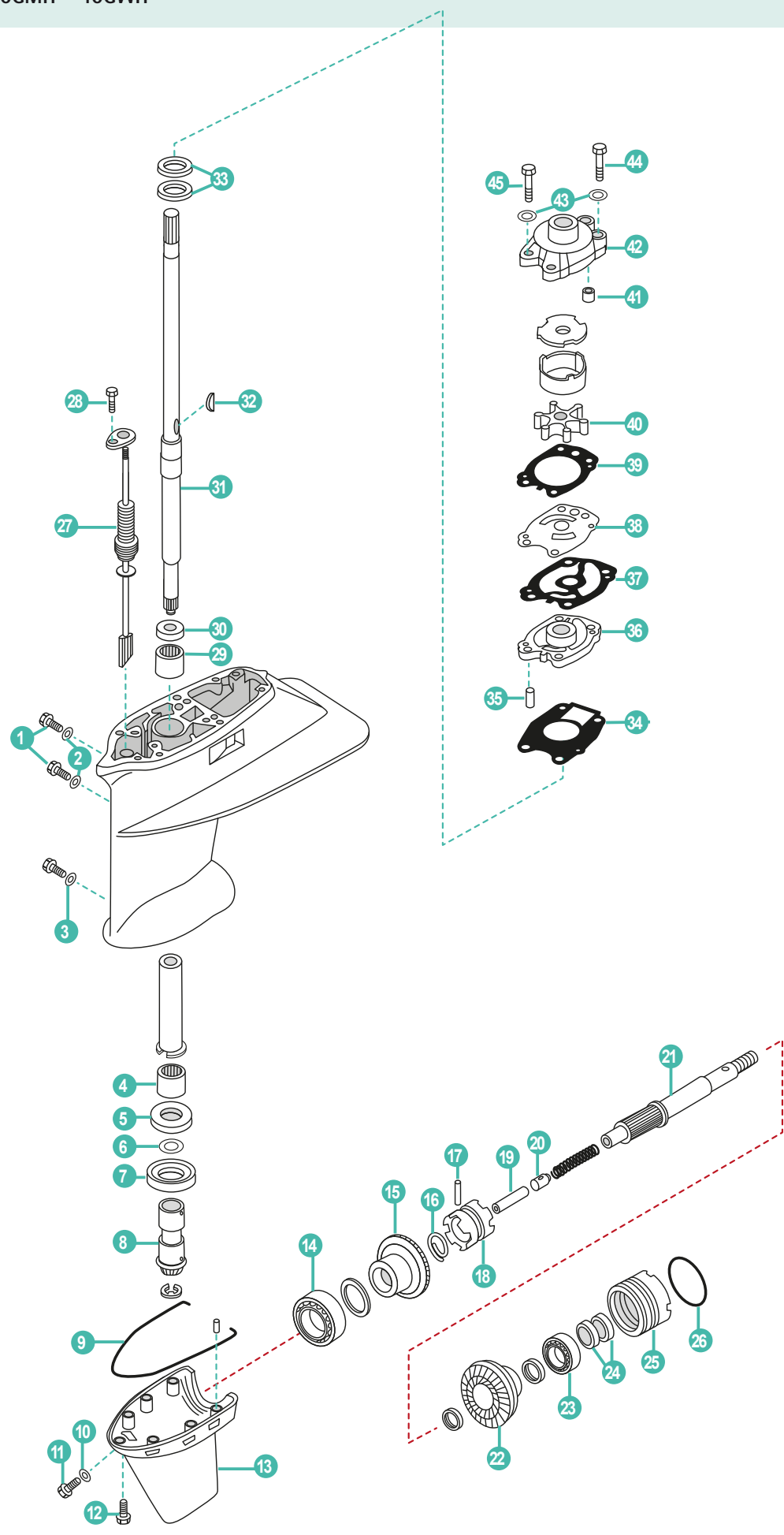

	REF	OEM				
1	REC90340-08002	90340-08002	TORNILLO, DRENAJE	BOLT DRAIN	VITE	BOUCHON DE VIDANGE
2	REC90430-08020	90430-08020	JUNTA	GASKET	GUARNIZIONE	JOINT
3	REC90430-06M03	90430-06M03	JUNTA	GASKET	GUARNIZIONE	JOINT
4	REC93315-324U1	93315-324U1	COJINETE DE RODILLOS	BEARING	CUSCINETTO	ROULEMENT
5	REC93342-624U0	93342-624U0	COJINETE CON RODAMIENTOS	BEARING	CUSCINETTO	ROULEMENT
6	REC676-45587-00	676-45587-00-70	GRUESO	SHIM (t:0.070mm)	SPESSORE	CALE (0.070mm)
	REC676-45587-00-75	676-45587-00-75	GRUESO	SHIM (t:0.075mm)	SPESSORE	CALE (0.075mm)
	REC676-45587-00-80	676-45587-00-80	GRUESO	SHIM (t:0.080mm)	SPESSORE	CALE (0.080mm)
7	REC93390-000U0	93390-000U0	COJINETE DE RODILLOS	BEARING	CUSCINETTO	ROULEMENT
8	REC6F5-45551-00	6F5-45551-00	PIÑÓN	PINION (13T)	PIGNONE	PIGON (13D)
9	REC676-45314-00	676-45314-00	SELLO DE FUNDA INFERIOR	SEAL	BOCCOLA COPERCHIO INFERIORE	JOINT DE CARTER INFERIEUR
10	REC90430-08020	90430-08020	JUNTA	GASKET	GUARNIZIONE	JOINT
11	REC688-45341-00	688-45341-10	TAPÓN, DREN	BOLT DRAIN	TAPPO	BOUCHON DE VIDANGE
12	REC90105-06M01	90105-06M01	TORNILLO	BOLT	VITE	VIS
13	REC6F5-45312-00-4D	6F5-45312-01-4D	FUNDA INFERIOR	CASING	COPERCHIO INFERIORE	CARTER INFERIEUR
14	REC93332-000U0	93332-000U0	COJINETE	BEARING	CUSCINETTO	ROULEMENT
15	REC6F5-45560-00	6F5-45560-00	PIÑÓN MARCHA AVANTE	POSITIVE GEAR ASSY	PIGNONE MARCIA AVANTI	PIGNON DE MARCHÉ AVANT
16	REC663-45633-00	663-45633-00	ANILLO DE PASADOR	RING, CROSS PIN	O-RING	JOINT TORIQUE
17	REC90250-06023	90250-06023	PASADOR CILÍNDRICO	PIN, STRAIGHT	SPINOTTO	PIN
18	REC663-45631-00	663-45631-01	EMBRAGUE DE GARRA	CLUTCH DOG	GIUNTO A DENTI FRONTALI	CRABOT
19	REC676-45635-00	676-45635-00	ÉMBOLO DE CAMBIO	PLUNGER SHIFT	CAMBIO PISTONE	PISTON
20	REC663-45634-00	663-45634-00	DESIZADOR, CAMBIO	SLIDE SHIFT	SCORREVOLE	DOUILLE
21	REC6F6-45611-00	6F6-45611-00	EJE PROPULSOR	SHAFT PROPELLER	ASSE GIRANTE	ARBRE D'HELICE
22	REC6F5-45570-00	6F5-45570-00	ENGRANAJE COMPL. 2.	GEAR	INGRANAGGIO	PIGNON
23	REC93306-204Y7	93306-20401	COJINETE (B6204)	BEARING	CUSCINETTO	ROULEMENT
24	REC93101-20048	93101-20048	SELLO ACEITE	OIL SEAL	PARAOLIO	JOINT SPI
25	REC676-45361-00	676-45361-01-94	FUNDA INFERIOR	CAP LOWER CASING	COPERCHIO INFERIORE	DIABOLO
26	REC93210-57M00	93210-57M00	ARO TÓRICO	O-RING	O-RING	JOINT TORIQUE
27	REC650-44147-00	650-44147-00	HULE DE VARILLA	BOOT, SHIFT ROD	AVVIO, BARRA DI SPOSTAMENTO	GUIDE
28	PAGB/T5783-M6X10	97095-06010	PERNO	BOLT	VITE	VIS
29	REC93315-217U0	93315-217U0	COJINETE DE RODILLOS	BEARING	CUSCINETTO	ROULEMENT
30	REC676-45533-00	676-45533-00	ARANDELA DE EMPUJE AXIAL	WASHER	RONDELLA	RONDELLE
31	REC676-45501-10	676-45501-10	EJE DE MANDO COMPL.	DRIVE SHAFT	ASSE VERTICALE	ARBRE VERTICAL
32	REC90280-04M00	90280-04M00	CUNA WOODRUFF	KEY WOODRUFF	CHIAVE WOODRUFF	CLAVETTE
33	REC93101-22M00	93101-22M00	SELLO ACEITE	OIL SEAL	PARAOLIO	JOINT SPI
34	REC676-44316-A1	676-44316-A1	EMPAQUE	GASKET	GUARNIZIONE	JOINT
35	PAF25-04000007	93604-08062	PASADOR DE CLAVIJA	PIN, DOWEL	SPINOTTO	CLAVETTE
36	REC676-44341-00	676-44341-94	CAJA BOMBA DE AGUA	HOUSING WATER PUMP	ALLOGGIAMENTO POMPA ACQUA	BASE DE POMPE À EAU
37	REC676-44324-A0	676-44324-A1	EMPAQUE	GASKET	GUARNIZIONE	JOINT
38	REC676-44323-00-40	676-44323-40	PLACA EXTERIOR DEL CARTUCHO	PLATE	PIASTRA	PLAQUE DE POMPE À EAU
39	REC676-44315-00	676-44315-A1	EMPAQUE	GASKET	GUARNIZIONE	JOINT
40	REC6F5-44352-00	6F5-44352-00	IMPULSOR	IMPELLER	GIRANTE	TURBINE
41	REC663-44366-00	663-44366-00	GOMA DEL SELLO DE AGUA	DAMPER WATER SEAL	BOCCOLA GOMMA ACQUA	BAGUE
42	REC676-44311-00	676-44311-00	CAJA BOMBA AGUA	HOUSING WATER PUMP	ALLOGGIAMENTO POMPA ACQUA	CORPS DE POMPE À EAU
43	PAGB/T97.1-8	92995-08600	ARANDELA	WASHER	RONDELLA	RONDELLE
44	REC97095-08055	97095-08055	PERNO	BOLT	VITE	VIS
45	REC97095-08045	97095-08045	PERNO	BOLT	VITE	VIS



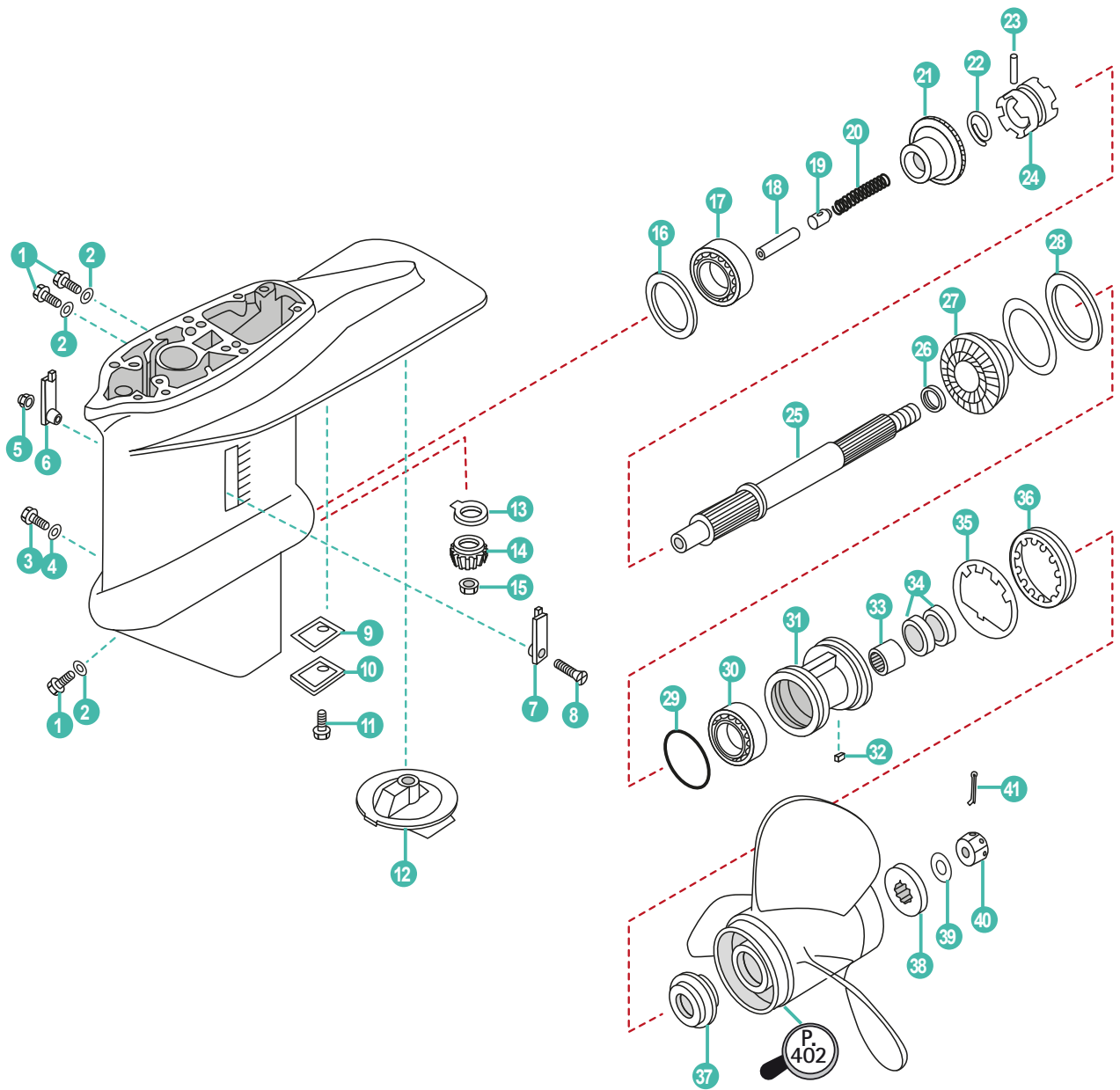

	REF	OEM				
1	REC90340-08002	90340-08M14	TORNILLO NIVEL ACEITE	VENT PLUG	VITE LIVELLO OLIO	BOUCHON DE VIDANGE
2	REC90430-08020	90430-08020	ARANDELA	WASHER	RONDELLA	RONDELLE
3	REC90149-06M00	90149-06M00	TORNILLO DRENAJE	DRAIN SCREW	VITE DRENAGGIO	BOUCHON DE VIDANGE
4	REC90430-06M03	90430-06M03	JUNTA	GASKET	GUARNIZIONE	JOINT
5	PAGB/T889.1-M5		TUERCA	NUT	DADO	ÉCROU
6	REC688-45215-02	688-45215-02	TAPA ENTRADA DE AGUA	WATER SCREEN	COPERCHIO RAFFREDDAMENTO	GRILLE D'ENTREE D'EAU
7	REC688-45214-02	688-45214-02	TAPA ENTRADA DE AGUA	WATER SCREEN	COPERCHIO RAFFREDDAMENTO	GRILLE D'ENTREE D'EAU
8	PAGB/T820-M5X30		TORNILLO	SCREW	VITE	VIS
9	REC679-45315-A1	679-45315-A1	JUNTA	GASKET	GUARNIZIONE	JOINT
10	REC679-45321-02	679-45321-02	PLACA	PLATE	PIASTRA	PLAQUE
11	PAGB/T818-M6X16	98580-06016	TORNILLO	SCREW	VITE	VIS
12	TEN01101	679-45371-00	ÁNODO	ANODE	ANODO	ANODE
13	REC663-45552-00	663-45552-00	COJINETE PLANO	BEARING	CUSCINETTO	ROULEMENT
14	REC6H9-45551-00	6H9-45551-00	PIÑÓN ATAQUE	INITIATIVE GEAR	MARCIA INIZIATIVA	PIGNON D'ATTAQUE
15	REC90170-12138	90170-012138	TUERCA	NUT	DADO	ÉCROU
	PAT40-04000004-1	663-45567-01-10	GRUESO (0.10mm)	SHIM (0.10mm)	SPESSORE (0.10mm)	CALE (0.10mm)
16	PAT40-04000004-2	663-45567-01-12	GRUESO (0.12mm)	SHIM (0.12mm)	SPESSORE (0.12mm)	CALE (0.12mm)
	PAT40-04000004-3	663-45567-01-15	GRUESO (0.15mm)	SHIM (0.15mm)	SPESSORE (0.15mm)	CALE (0.15mm)
	PAT40-04000004-5	663-45567-01-30	GRUESO (0.30mm)	SHIM (0.30mm)	SPESSORE (0.30mm)	CALE (0.30mm)
17	REC93332-00003	93332-00003	COJINETE	BEARING	CUSCINETTO	ROULEMENT
18	REC676-45635-00	676-45635-00	ÉMBOLO DE CAMBIO	PIVOT	PERNO	PIVOT
19	REC663-45634-00	663-45634-00	DESILIZADOR DE CAMBIO	CLUTCH DOG	TRAINABILE CAMBIO	PISTON
20	REC90501-16M01	90501-16M01	RESORTE DE COMPRESIÓN	SPRING	MOLLA	RESSORT
21	REC679-45560-00	679-45560-00	PIÑÓN MARCHA AVANTE	POSITIVE GEAR ASSY	PIGNONE MARCIA AVANTI	PIGNON DE MARCHE AVANT
22	REC663-45633-00	663-45633-00	ANILLO DEL PASADOR	ANNULAR SPRING, CLUTCH	ANELLO	RESSORT
23	REC90250-06023	90250-06023	PASADOR	PIN	FERMO	GOUPILLE
24	REC663-45631-00	663-45631-01	EMBRAGUE DE GARRA	CLUCH DOG	SELETTORE	CRABOT
25	REC679-45611-00	679-45611-01	EJE PROPULSOR	PROPELLER SHAFT	ASSE ELICA	ARBRE D'HELICE
26	REC90201-22429	90201-22429	ARANDELA PLANA	WASHER	RONDELLA	RONDELLE
27	REC679-45571-00	679-45571-00	PIÑÓN MARCHA ATRÁS	REVERSE GEAR	PIGNONE MARCIA INDIETRO	PIGNON MARCHE ARRIÈRE
28	REC663-45576-00	663-45576-00	ARANDELA DE EMPUJE	PUSH WASHER	RONDELLA DI SPINTA	RONDELLE D'APPUI
29	REC93210-66M98	93210-66M98	O-RING	O-RING	O-RING	JOINT TORIQUE
30	REC93306-00702	93306-00702	COJINETE	BEARING	CUSCINETTO	ROULEMENT
31	REC679-45331-00	679-45331-00-94	DIABOLO	DIABOLO	DIABOLO	DIABOLO
32	REC90282-04010	90282-04010	CHAVETA	KEY	CHIAVETTE	CLAVETTE
33	REC93317-22204	93317-22204	COJINETE	BEARING	CUSCINETTO	ROULEMENT
34	REC93101-22067	93101-22067	RETÉN DE ACEITE	SEAL OIL	PAROLIO	JOINT SPI
35	REC90214-48M03	90214-48M03	ARANDELA	WASHER	RONDELLA	RONDELLE
36	REC697-45384-00	697-45384-00	TUERCA	NUT	DADO	ÉCROU
37	REC663-45987-00	663-45987-00	ESPACIADOR	DISTANCE WASHER	DISTANZIALE	ENTRETOISE
38	REC66T-45997-00	66T-45997-00	ESPACIADOR	DISTANCE WASHER	DISTANZIALE	ENTRETOISE
39	REC90389-22M01	90389-22M01	ARANDELA	WASHER	RONDELLA	RONDELLE
40	REC90171-16011	90171-16011	TUERCA	NUT	DADO	ÉCROU D'HELICE
41	REC91490-30025	91490-30025	CLIP	CLIP	CLIP	GOUPILLE



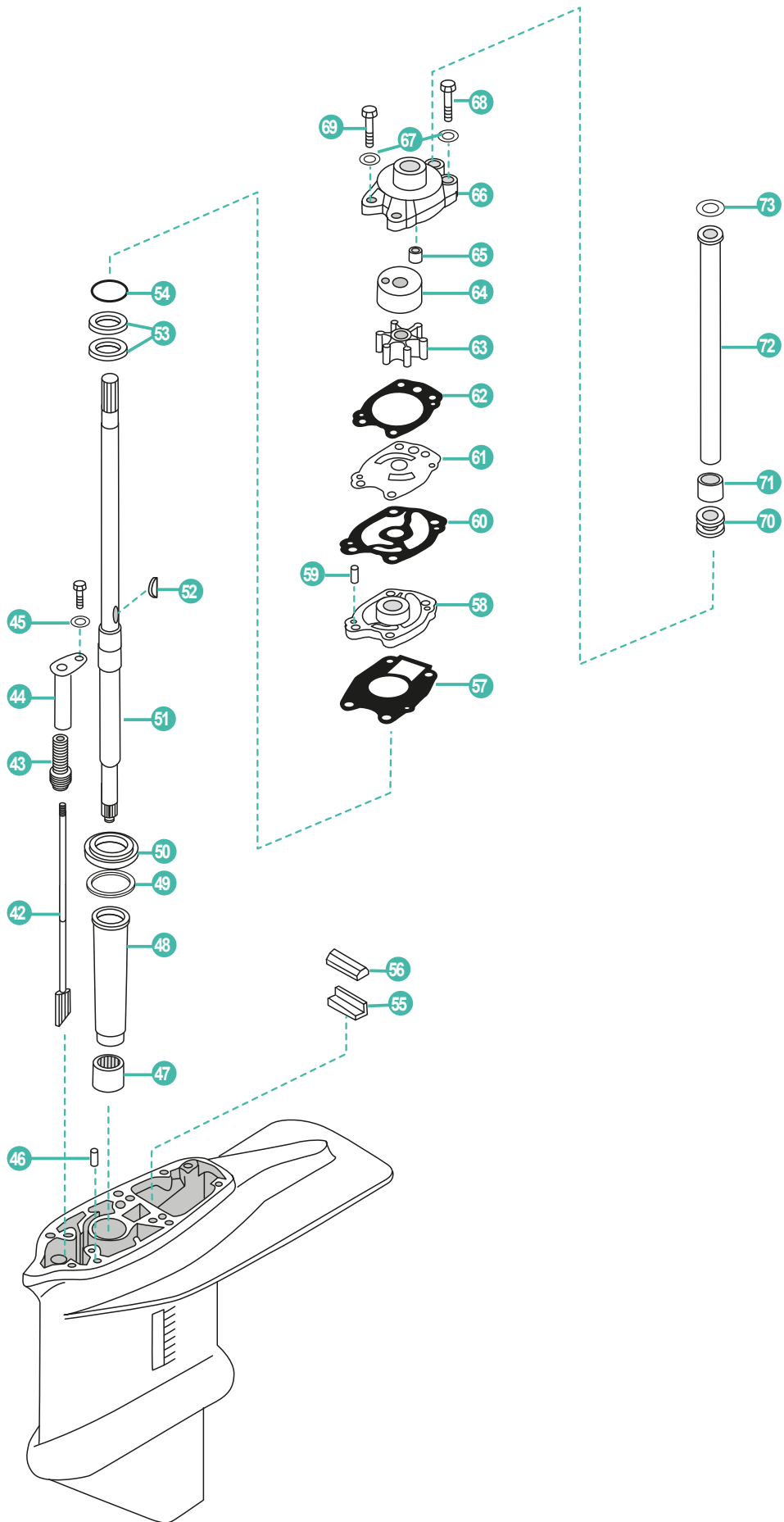

	REF	OEM				
42	REC679-44150-10	679-44150-10	EJE SELECTOR L	SHAFT SELECTOR L	ASSE SELETTORE L	ARBRE SELECTEUR L
	REC679-44150-00	679-44150-00	EJE SELECTOR S	SHAFT SELECTOR S	ASSE SELETTORE S	ARBRE SELECTEUR S
43	REC650-44147-00	650-44147-00	FUELLE EJE	BOOT, SHIFT ROD	BOOT, SHIFT ROD	SOUFFLET
44	REC679-44152-00	679-44152-00	BUJE LEVE DE CAMBIO	HUBE GEAR LEVE	MOZZO LEVA CAMBIO	LEVIER DE VITESSE
45	PAGB/T97.1-6	92990-06600	ARANDELA PLANA	WASHER	RONDELLA	RONDELLE
46	REC93606-12019	93606-12019	PIN CENTRADOR	PIN DOWEL	SPINOTTO DI CENTRAGGIO	CLAVETTE DE CENTRAGE
47	REC93315-32224	93315-32224	COJINETE	BEARING	CUSCINETTO	ROULEMENT
48	REC679-45536-00	679-45536-00	CAMISA EJE TRASMISION	BUSHING NYLON	CAMICIA ASSE TRASMISSIONE	AXE TRANSMISSION
	PAT40-04000003-1	663-45587-01-10	GRUESO (0.10mm)	SHIM (0.10mm)	SPESSORE (0.10mm)	CALE (0.10mm)
	PAT40-04000003-2	663-45587-01-12	GRUESO (0.12mm)	SHIM (0.12mm)	SPESSORE (0.12mm)	CALE (0.12mm)
	PAT40-04000003-3	663-45587-01-15	GRUESO (0.15mm)	SHIM (0.15mm)	SPESSORE (0.15mm)	CALE (0.15mm)
49	PAT40-04000003-4	663-45587-01-18	GRUESO (0.18mm)	SHIM (0.18mm)	SPESSORE (0.18mm)	CALE (0.18mm)
	PAT40-04000003-5	663-45587-01-30	GRUESO (0.30mm)	SHIM (0.30mm)	SPESSORE (0.30mm)	CALE (0.30mm)
	PAT40-04000003-6	663-45587-01-40	GRUESO (0.40mm)	SHIM (0.40mm)	SPESSORE (0.40mm)	CALE (0.40mm)
	PAT40-04000003-7	663-45587-01-50	GRUESO (0.50mm)	SHIM (0.50mm)	SPESSORE (0.50mm)	CALE (0.50mm)
50	PAT40-04000027	93332-00079	COJINETE	BEARING	CUSCINETTO	ROULEMENT
51	REC679-45501-10	679-45501-10	EJE L	SHAFT L	ASSE L	ARBRE L
52	REC90280-04M00	90280-04M00	CHAVETA	KEY	CHIAVETTA	CLAVETTE
53	REC93101-22067	93101-22067	RETÉN DE ACEITE	SEAL OIL	PARAOILIO	JOINT SPI
54	REC93210-41042	93210-41042	TÓRICA	O-RING	O-RING	JOINT TORIQUE
55	REC663-45376-00	663-45376-00	GUIA RETEN	GUIDE RUB. SEAL	GUIDA PARAOILIO	GUIDE
56	REC663-45375-00	663-45375-00	GOMA SELLADORA	SEALING RUBBER	ANELLO SIGILLANTE	JOINT CAOUTCHOUC
57	REC679-44316-A0	679-44316-A0	JUNTA	GASKET	GUARNIZIONE	JOINT
58	REC679-44341-00	679-44341-00-94	CAJA BOMBA DE AGUA	WATER PUMP HOUSING	SCATOLA POMPA ACQUA	BASE DE POMPE À EAU
59	PAF25-04000007	93604-08062	PASADOR	PIN	FERMO	GOUPILLE
60	REC676-44324-A0	676-44324-A0	JUNTA	GASKET	GUARNIZIONE	JOINT
61	REC676-44323-00-40	676-44323-00	PLACA EXTERIOR DEL CARTUCHO	OUTER PLATE	PLACCA ESTERNA	PLAQUE DE POMPE À EAU
62	REC676-44315-00	676-44315-A0	JUNTA	GASKET	GUARNIZIONE	JOINT
63	REC6F5-44352-00	6F5-44352-002	IMPULSOR	IMPELLER	GIRANTE	TURBINE
64	REC676-44322-00	676-44322-00	CASQUILLO INOX	CARTRIDGE INSERT	BOCCOLA	INSERT DE POMPE À EAU
65	REC663-44366-00	663-44366-00	RETEN TUBO AGUA	DAMPER, WATER SEAL	GHIERA	JOINT DE TUBE D'EAU
66	REC676-44311-00	676-44311-00	CAJA BOMBA DE AGUA	WATER PUMP HOUSING	SCATOLA POMPA ACQUA	CORPS DE POMPE À EAU
67	PAGB/T97.1-8	92990-08600	ARANDELA PLANA	WASHER	RONDELLA	RONDELLE
68	REC97095-08055	97095-08055	PERNO	BOLT	BOULONE	BOULON
69	REC97095-08045	97095-08045	PERNO	BOLT	BOULONE	BOULON
70	PAT40-02000002	663-44367-00	GOMA DEL SELLO DE AGUA	GUIDE BUSHING, WATER PIPE	GUARNIZIONE	GUIDE DE PIPE D'EAU
71	REC90430-12072	90430-12072	JUNTA	GASKET	GUARNIZIONE	JOINT
72	REC676-44361-00	676-44361-00	TUBO S	TUBE S	TUBO S	TUBE S
	REC676-44361-10	676-44361-10	TUBO L	TUBE L	TUBO L	TUBE L
73	PAF25-02000019	90202-12060	GOMA DEL SELLO DE AGUA	GUIDE BUSHING, WATER PIPE	GUARNIZIONE	GUIDE DE PIPE D'EAU



REF  
REC80W90U3  
REC80W90U6  
RECGREU1  
RECGREU12

2T 55ED • 55ET • 55B/BM/BT  
STROKES

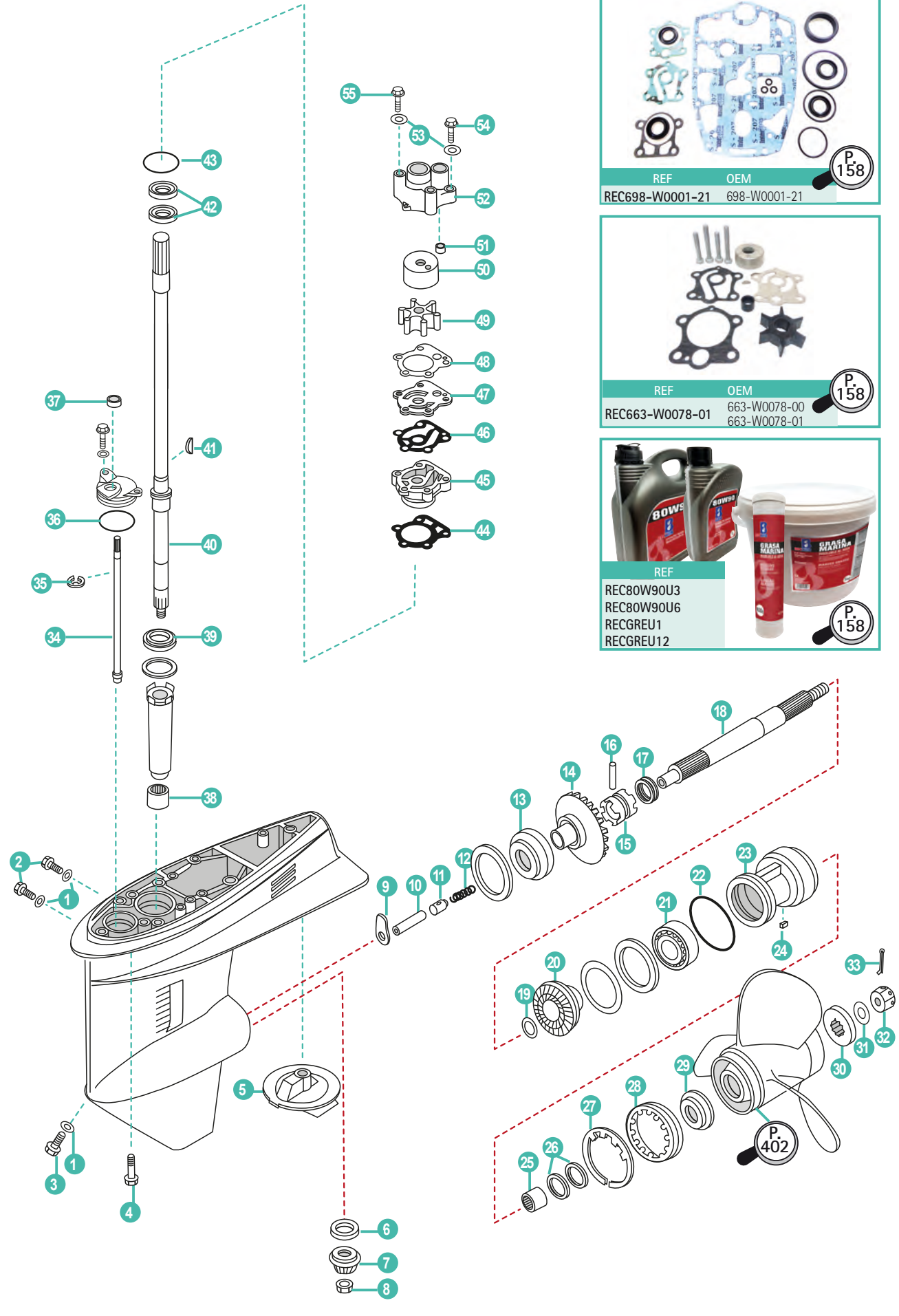

	REF	OEM				
1	REC90430-08020	90430-08020	JUNTA	GASKET	GUARNIZIONE	JOINT
2	REC90340-08002	90340-08002	TORNILLO	STRAIGHT SCREW	VITE	VIS
3	REC688-45341-00	688-45341-10	TAPÓN, DREN	PLUG, DRAIN	TAPPO	BOUCHON DE VIDANGE
4	REC97075-10040	97075-10040	PERNO	BOLT	PERNO	BOULON
5	TEN01101	679-45371-00	ÁNODO	ANODE	ANODO	ANODE
6	REC663-45552-00	663-45552-00	COJINETE PLANO	BEARING, PLAIN	CUSCINETTO PIATO	ROULEMENT
7	REC697-45551-00	697-45551-00	PIÑÓN ATAQUE	INITIATIVE GEAR	MARCIA INIZIATIVA	PIGNON D'ATTAQUE
8	REC90170-12138	90170-12138	TUERCA	NUT	DADO	ÉCROU
9	REC663-44151-00	663-44151-00	LEVA DE CAMBIO	CAM SHIFT	ALBERO	CAME
10	REC688-45635-00	688-45635-00	PLUNGER, SHIFT	ÉMBOLO DE CAMBIO	CAMBIO PISTONE	PISTON
11	REC663-45634-00	663-45634-00	DESILIZADOR CAMBIO	SLIDE, SHIFT	SCORREVOLE	DOUILLE
12	REC90501-16233	90501-16233	RESORTE DE COMPRESIÓN	SPRING	MOLLA	RESSORT
13	REC93332-00003	93332-00003	COJINETE	BEARING	CUSCINETTO	ROULEMENT
14	REC697-45560-00	697-45560-00	PIÑÓN MARCHA AVANTE	POSITIVE GEAR ASSY	PIGNONE MARCIA AVANTI	PIGNON DE MARCHÉ AVANT
15	REC663-45631-00	663-45631-01	EMBRAGUE DE GARRA	CLUTCH, DOG	GIUNTO A DENTI FRONTALE	CRABOT
16	REC90250-06023	90250-06023	PASADOR CILÍNDRICO	PIN, STRAIGHT	SPINOTTO	PIN
17	REC663-45633-00	663-45633-00	ANILLO DE PASADOR	RING, CROSS PIN	O-RING	JOINT TORIQUE
18	REC697-45611-00	697-45611-00	EJE PROPULSOR	SHAFT PROPELLER	ASSE	ARBRE D'HELICE
19	REC90201-22429	90201-22429	ARANDELA PLANA	WASHER, PLATE	RONDELLA	RONDELLE
20	REC697-45570-00	697-45571-00	PIÑÓN MARCHA ATRÁS	REVERSE GEAR	PIGNONE MARCIA INDIETRO	PIGNON MARCHÉ ARRIÈRE
21	REC93306-00702	93306-00702	COJINETE	BEARING	CUSCINETTO	ROULEMENT
22	REC93210-66M98	93210-66M98	ANILLO O	O- RING	O-RING	JOINT TORIQUE
23	REC663-45331-00-94	663-45331-00-94	CAJA DE COJINETE	HOUSING, BEARING	SEDE CUSCINETTO	DIABOLO
24	REC90282-04010	90282-04010	CHAVETA	KEY, STRAIGHT	CHIAVETTA	CLAVETTE
25	REC93317-22204	93317-22204	COJINETE	BEARING	CUSCINETTO	ROULEMENT
26	REC93101-22067	93101-22067	SELLO ACEITE	OIL SEAL	PARAOLIO	JOINT SPI
27	REC90214-48M03	90214-48M03	ARANDELA	WASHER	RONDELLA	RONDELLE
28	REC697-45384-00	697-45384-00	TUERCA	NUT	DADO	ÉCROU
29	REC663-45987-00	663-45987-02	ESPACIADOR	SPACER	DISTANZIALE	ENTRETOISE
30	REC670-45997-00	670-45997-02	ESPACIADOR	SPACER	DISTANZIALE	ENTRETOISE
31	REC92990-16200	92990-16200	ARANDELA PLANA	WASHER, PLAIN	RONDELLA	RONDELLE
32	REC90171-16011	90171-16011	TUERCA ENTALLADA	NUT, CASTLE	DADO	ÉCROU D'HELICE
33	REC91490-40030	91490-40025	CHAVETA	PIN, COTTER	CHIAVETTA	GOUPILLE
34	REC663-44144-01	663-44144-01	VARILLA DE CAMBIO	ROD, SHIFT	ASTICELLA	LEVIER DE VITESSE
35	REC99001-08600-00	99001-08600	CLIP	CLIP	CLIP	CLAVETTE
36	REC93210-49046	93210-49046	ANILLO	O-RING	O-RING	JOINT TORIQUE
37	REC93106-09014	93106-09014	RETÉN DE ACEITE	OIL SEAL	PARAOLIO	JOINT SPI
38	REC93315-32224	93315-32224	COJINETE DE RODILLOS	BEARING	CUSCINETTO	ROULEMENT
39	REC93332-00001	93332-00001	COJINETE	BEARING	CUSCINETTO	ROULEMENT
40	REC663-45510-01	663-45510-01	EJE DE MANDO	DRIVE SHAFT ASSY	ASSE VERTICALE	ARBRE VERTICAL
41	REC90280-03M03	90280-03M03	CHAVETA	KEY, WOODRUFF	CHIAVE	CLAVETTE
42	REC93101-23070	93101-23070	SELLO ACEITE	OIL SEAL	PARAOLIO	JOINT SPI
43	REC93210-41042	93210-41042	ANILLO O	O-RING	O-RING	JOINT TORIQUE
44	REC663-44316-A0	663-44316-A0	EMPAQUE	GASKET, WATER PUMP	GUARNIZIONE	JOINT DE POMPE À EAU
45	REC663-44311-02	663-44341-00	CAJA BOMBA	HOUSING, WATER PUMP	CORPO POMPA	BASE DE POMPE À EAU
46	REC663-44324-00	663-44324-A0	EMPAQUE	GASKET, CARTRIDGE	GUARNIZIONE	JOINT
47	REC663-44323-00	663-44323-00	PLACA EXTERIOR	OUTTER PLATE	PIASTRA EXT.	PLAQUE DE POMPE À EAU
48	REC663-44315-A0	663-44315-A0	EMAPAQUE	GASKET, WATER PUMP	GUARNIZIONE	JOINT
49	REC6H3-44352-00	697-44352-00	IMPULSOR	IMPELLER	GIRANTE	TURBINE
50	REC663-44322-00	663-44322-00	CARTUCHO	INSERT CARTRIDGE	CARTUCCIA	INSERT DE POMPE À EAU
51	REC663-44366-00	663-44366-00	GOMA SELLO	DAMPER, WATER SEAL	BOCCOLA GOMMA	BAGUE
52	REC663-44311-02	663-44311-02	CAJA BOMBA	HOUSING, WATER PUMP	CORPO POMPA	CORPS DE POMPE À EAU
53	PAGB/T97.1-8	92995-08600	ARANDELA	WASHER	RONDELLA	RONDELLE
54	REC97095-08045	97095-08045	PERNO	BOLT	VITE	VIS
55	REC97095-08055	97095-08055	PERNO	BOLT	VITE	VIS



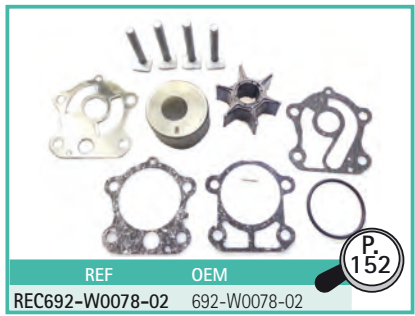
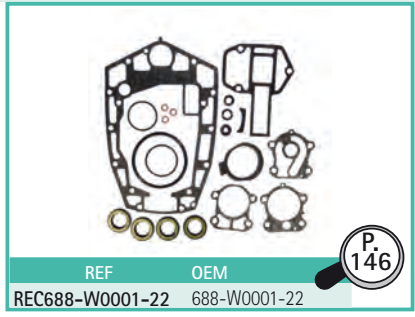
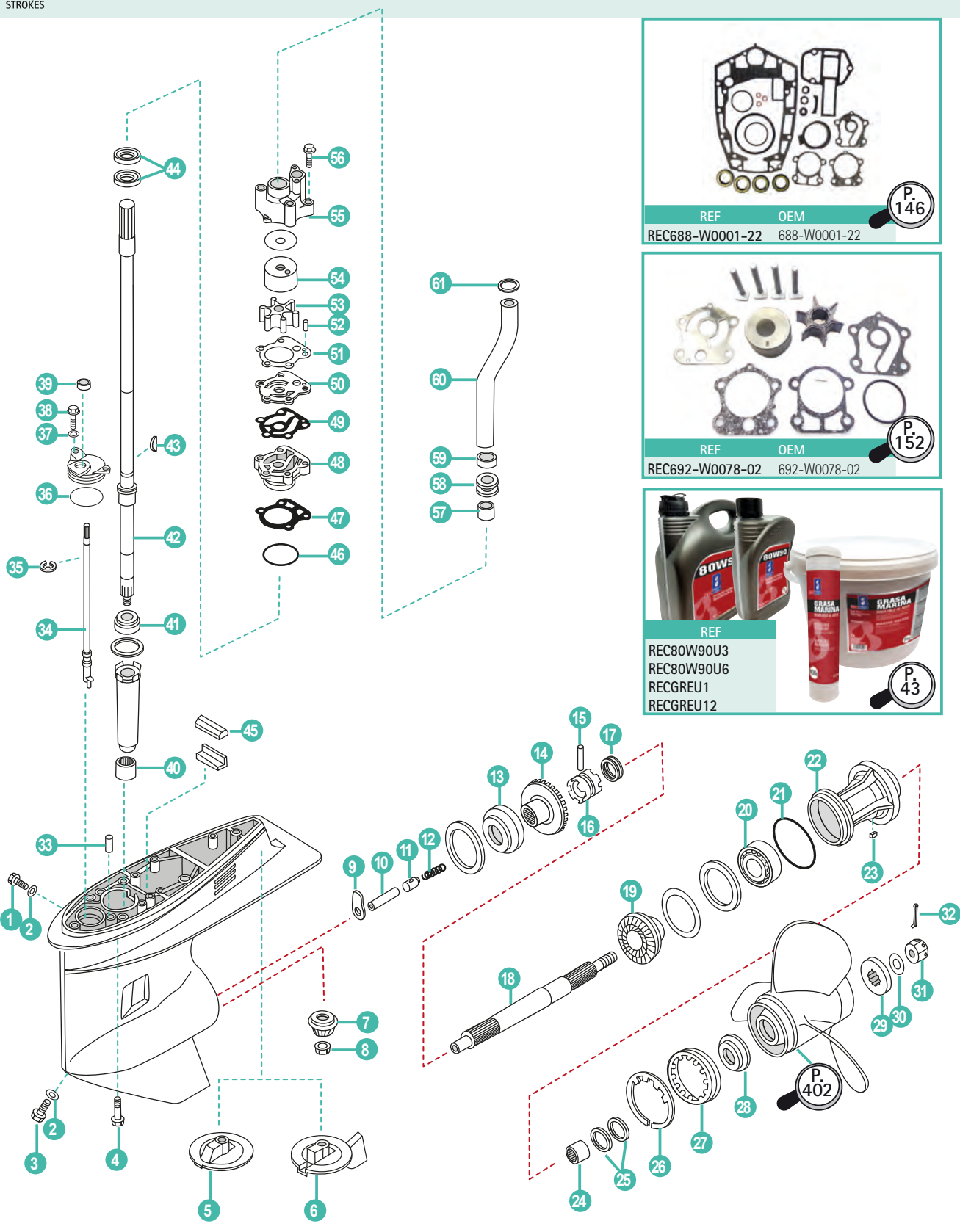

	REF	OEM				
	REC692-45300-16-8D	692-45300-14-4D	COLA COMPLETA L	LOWER UNIT ASSY L	PIEDE COMPLETO L	EMBASE COMPLETE L
1	REC90340-08002	90340-08002	TAPÓN	PLUG STRAIGHT SCREW	TAPPO	BOUCHON DE VIDANGE
2	REC90430-08020	90430-08020	JUNTA	GASKET	GUARNIZIONE	JOINT
3	REC688-45341-00	688-45341-10	TAPÓN	PLUG DRAIN	TAPPO	BOUCHON DE VIDANGE
4	REC97075-10040	97075-10040	TORNILLO	BOLT WITH WASHER	VITE	VIS
5	TEN01153	6E5-45371-10	ÁNODO TIMÓN	TAB-TRIM	ANODO	ANODE

	REF	OEM				
6	CM688-45371-02	688-45371-02	ÁNODO TIMÓN STD.	TAB-TRIM STD	ANODO STD	ANODE
7	REC688-45551-00	688-45551-01	PIÑÓN ATAQUE	INITIATIVE GEAR	MARCIA INIZIATIVA	PIGNON D'ATTAQUE
8	REC90170-16M01	90170-16M01	TUERCA	NUT	DADO	ECROU
9	REC663-44151-00	663-44151-00	LEVA	CAM, SHIFT	LEVA	CAME
10	REC688-45635-00	688-45635-00	BULÓN	PLUNGER, SHIFT	BULLONE	BOULON
11	REC688-45634-00	688-45634-00	EMPUJADOR	SLIDE, SHIFT	SCORREVOLE	DOUILLE
12	REC90501-16233	90501-16233	MUELLE	SPRING, COMPRESSION	MOLLA	RESSORT
13	REC93332-000W7	93332-000W7	RODAMIENTO	BEARING	CUSCINETTO	ROULEMENT
14	REC688-45560-00	688-45560-00	PIÑÓN MARCHA AVANTE	POSITIVE GEAR ASSY	PIGNONE MARCIA AVANTI	PIGNON DE MARCHÉ AVANT
15	REC90250-07M02	90250-07M02	PASADOR	PIN, STRAIGHT	SPINOTTO	PIN
16	REC688-45631-00	688-45631-01	DESPLAZABLE	CLUTCH, DOG	GIUNTO A DENTI FRONTALE	CRABOT
17	REC688-45633-00	688-45633-00	ARO METÁLICO	RING, CROSS PIN	O-RING	JOINT TORIQUE
18	REC688-45611-00	688-45611-00	EJE HÉLICE	SHAFT, PROPELLER	ASSE ELICA	ARBRE D'HELICE
19	REC688-45570-00	688-45571-01	PIÑÓN MARCHA ATRÁS	REVERSE GEAR	PIGNONE MARCIA INDIETRO	PIGNON MARCHÉ ARRIÈRE
20	REC93306-207U0	93306-207U0	RODAMIENTO	BEARING	CUSCINETTO	ROULEMENT
21	REC93210-85M97	93210-85M97	ARO TÓRICO	O-RING	O-RING	JOINT TORIQUE
22	REC688-45331-00-94	688-45331-00-94	DIÁBOLO	HOUSING, BEARING	COP. CASSA INGRANAGGI	DIABOLO
23	REC90282-04010	90282-04010	CHAVETA	KEY, STRAIGHT	CHIAVETTA	CLAVETTE
24	REC93317-325U0	93317-325U0	RODAMIENTO	BEARING	CUSCINETTO	ROULEMENT
25	REC93101-25M03	93101-25M03	RETÉN	OIL SEAL	PARAOLIO	JOINT SPI
26	REC688-45383-01	688-45383-02	ARANDELA CIERRE	WASHER, CLAW	RONDELLA CHIUSURA	RONDELLE
27	REC688-45384-00	688-45384-00	TUERCA	NUT	DADO	ECROU
28	REC688-45987-00	688-45987-01	SEPARADOR	SPACER	DISTANZIALE	ENTRETOISE
29	REC67F-45997-00	67F-45997-00	SEPARADOR	SPACER	DISTANZIALE	ENTRETOISE
30	REC90389-25M00	90389-25M00	CASQUILLO	BUSH	BOCCOLA	RONDELLE
31	REC90171-16011	90171-16011	TUERCA	NUT, CASTLE	DADO	ECROU D'HELICE
32	REC91490-40030	91490-40025	PASADOR ALETAS	PIN, COTTER	SPINOTTO	GOUPILLE
33	REC93606-12019	93606-12019	PASADOR	PIN, DOWEL	SPINOTTO	PIN
34	REC663-44144-01	663-44144-01	EJE SELECTOR	ROD, SHIFT	ASSE SELETTORE	ARBRE DE VITESSE
35	REC99001-08600-00	99001-08600	CERCLIP	CIRCLIP	CIRCLIP	CIRCLIP
36	REC93210-49046	93210-49046	ARO TÓRICO	O-RING	O-RING	JOINT TORIQUE
37	PAGB/T5783-M6X16	92995-06600	ARANDELA	WASHER	RONDELLA	RONDELLE
38	PAGB/T97.1-6	97095-06016	TORNILLO	BOLT	VITE	VIS
39	REC93106-09014	93106-09014	RETÉN	OIL SEAL	PARAOLIO	JOINT SPI
40	REC93315-325V1	93315-325V1	RODAMIENTO	BEARING	CUSCINETTO	ROULEMENT
41	REC93332-000U3	93332-000U3	RODAMIENTO	BEARING	CUSCINETTO	ROULEMENT
42	REC688-45501-11	688-45501-11	EJE VERTICAL	DRIVE SHAFT COMP.	ASSE VERTICALE	ARBRE VERTICAL
43	REC90280-04M04	90280-04M04	CHAVETA	KEY, WOODRUFF	CHIAVETTA	CLAVETTE
44	REC93101-25M03	93101-25M03	RETÉN	OIL SEAL	PARAOLIO	JOINT SPI
45	REC688-45375-00	688-45375-00	RETÉN DAMPER	DAMPER WASHER	PARAOLIO DAMPER	JOINT SILENT BLOC
46	REC93210-46044	93210-46044	ARO TÓRICO	O-RING	O-RING	JOINT TORIQUE
47	REC688-44316-00	688-44316-A0	JUNTA	GASKET WATER PUMP	GUARNIZIONE	JOINT DE POMPE À EAU
48	REC688-44341-01	688-44341-01-94	TAPA INF. BOMBA AGUA	HOUSING, WATER PUMP	CORPO INF. POMPA ACQUA	BASE DE POMPE À EAU
49	REC688-44324-00	688-44324-A0	JUNTA	GASKET, CARTRIDGE	GUARNIZIONE	JOINT
50	REC688-44323-00	688-44323-40	PLATO	OUTTER PLATE, CARTRIDGE	PIASTRA	PLAQUE DE POMPE À EAU
51	REC688-44315-00	688-44315-A0	JUNTA	GASKET, WATER PUMP	GUARNIZIONE	JOINT
52	PAF25-04000007	93604-10M03	CENTRADOR	PIN, DOWEL	SPINOTTO	PIN
53	REC688-44352-03	688-44352-03	TURBINA	IMPELLER	GIRANTE	TURBINE
54	REC688-44322-00	688-44322-00	CASQUILLO INOX.	INSERT, CARTRIDGE	BOCCOLA INOX.	INSERT DE POMPE À EAU
55	REC688-44311-01	688-44311-01	CUERPO BOMBA AGUA	HOUSING, WATER PUMP	CORPO POMPA ACQUA	CORPS DE POMPE À EAU
56	REC90119-08M13	90119-08M13	TORNILLO	BOLT WITH WASHER	VITE	VIS
57	REC663-44366-00	663-44366-00	CASQUILLO GOMA	DAMPER, WATER SEAL	BOCCOLA GOMMA	BAGUE
58	PAT40-02000002	663-44367-00	GOMA DEL SELLO DE AGUA	GUIDE BUSHING, WATER PIPE	GU	GUIDE DE PIPE D'EAU
59	REC90430-12072	90430-12072	JUNTA	GASKET	GUARNIZIONE	JOINT
60	REC688-44361-10	688-44361-10	TUBO DE AGUA L	WATER TUBE L	TUBO ACQUA L	TUBE D'EAU L
61	PAF25-02000019	90202-12060	ARANDELA	WASHER	RONDELLA	RONDELLE

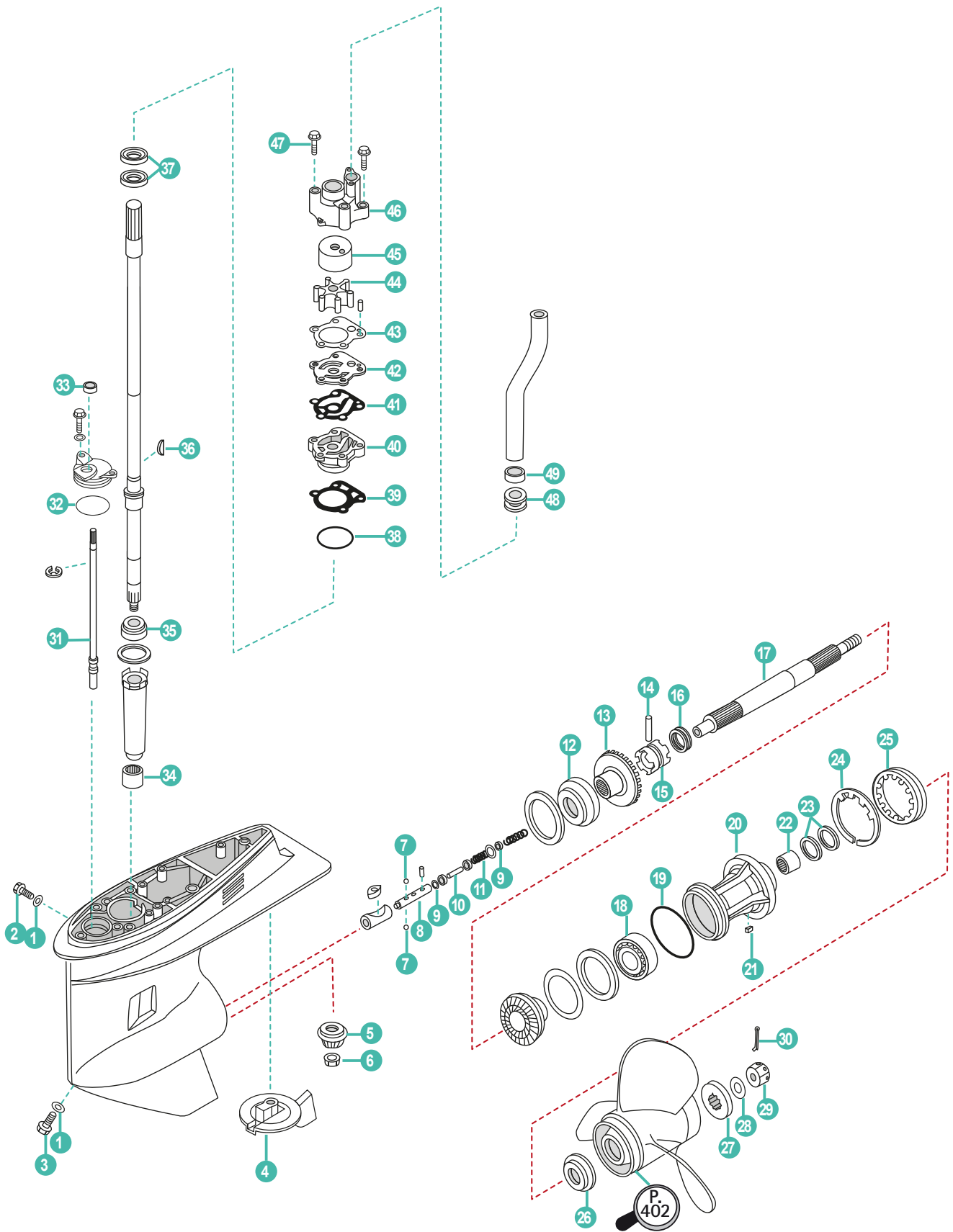

	REF	OEM				
1	REC90430-08020	90430-08020-00	JUNTA	GASKET	GUARNIZIONE	JOINT
2	REC90340-08002	90340-08002	TAPÓN	PLUG	TAPPO	BOUCHON DE VIDANGE
3	REC688-45341-00	688-45341-00-00	TAPÓN	PLUG	TAPPO	BOUCHON DE VIDANGE
4	CM688-45371-02	688-45371-02-00	ÁNODO	ANODE	ANODO	ANODE
5	REC688-45551-00	688-45551-01-00	PIÑÓN ATAQUE	INITIATIVE GEAR	MARCIA INIZIATIVA	PIGNON D'ATTAQUE
6	REC90170-16M01	90170-16M01-00	TUERCA	NUT	DADO	ECROU
7	REC93503-16003	93503-16003	ESFERA	BALL	SFERA	BILLE
8	REC6H1-45634-02	6H1-45634-02	DESPLAZABLE	SLIDE, SHIFT	SCORREVOLE	DOUILLE
9	REC90183-02M03	90183-02M03	TUERCA	NUT	DADO	ECROU
10	REC6H1-45668-00	6H1-45668-00	EJE	SHAFT	ASSE	ARBRE
11	REC90501-12M48	90501-12M48	RESORTE	SPRING	MOLLA	RESSORT
12	REC93332-000W7	93332-000W7-00	RODAMIENTO	BEARING	CUSCINETTO	ROULEMENT
13	REC688-45560-00	688-45560-00-00	PIÑÓN MARCHA AVANTE	POSITIVE GEAR ASSY	PIGNONE MARCIA AVANTI	PIGNON DE MARCHÉ AVANT
14	REC90250-07M02	90250-07M02-00	PASADOR	PIN	SPINOTTO	CLAVETTE
15	REC6H1-45631-01	6H1-45631-01-00	SELECTOR	CLUTCH	SELETTORE	CRABOT
16	REC688-45633-00	688-45633-00-00	MUELLE	SPRING	MOLLA	RESSORT
17	REC6H1-45611-00	6H1-45611-01-00	EJE HÉLICE	PROPELLER SHAFT	ASSE ELICA	ARBRE D'HELICE
18	REC93306-207U0	93306-207U0-00	RODAMIENTO	BEARING	CUSCINETTO	ROULEMENT
19	REC93210-85M97	93210-85M97-00	ARO TÓRICO	O-RING	O-RING	JOINT TORIQUE
20	REC688-45331-00-94	688-45331-00-94	DIABOLO	DIABOLO	DIABOLO	DIABOLO
21	REC90282-04010	90282-04010	CHAVETA	KEY	CHIAVETTA	CLAVETTE
22	REC93317-325U0	93317-325U0-00	RODAMIENTO	BEARING	CUSCINETTO	ROULEMENT
23	REC93101-25M03	93101-25M03-00	RETÉN	OIL SEAL	PARAOLIO	JOINT SPI
24	REC688-45383-01	688-45383-02-00	ARANDELA	WASHER	RONDELLA	RONDELLE
25	REC688-45384-00	688-45384-00-00	TUERCA	NUT	DADO	ECROU
26	REC688-45987-00	688-45987-01-00	ESPACIADOR	SPACER	DISTANZIALE	ENTRETOISE
27	REC688-45997-00	688-45997-01-00	ESPACIADOR	SPACER	DISTANZIALE	ENTRETOISE
28	REC90201-17M00	90201-17M00-00	ARANDELA	WASHER	RONDELLA	RONDELLE
29	REC90171-16011	90171-16011-00	TUERCA	NUT	DADO	ECROU D'HELICE
30	REC91490-40030	91490-40030-00	PASADOR	PIN	SPINOTTO	GOUPILLE
31	REC6H1-44144-00	6H1-44144-00	VARILLA CAMBIO	SHIFT ROD	ASSE SELETTORE	LEVIER DE VITESSE
32	REC93210-49046	93210-49046-00	ANILLO	O-RING	O-RING	JOINT TORIQUE
33	REC93106-09014	93106-09014-00	RETÉN	OIL SEAL	PARAOLIO	JOINT SPI
34	REC93315-325V1	93315-325V1-00	RODAMIENTO	BEARING	CUSCINETTO	ROULEMENT
35	REC93332-000U3	93332-000U3-00	RODAMIENTO	BEARING	CUSCINETTO	ROULEMENT
36	REC90280-04M04	90280-04M04-00	CHAVETA	KEY	CHIAVETTA	CLAVETTE
37	REC93101-25M03	93101-25M03-00	RETÉN	OIL SEAL	PARAOLIO	JOINT SPI
38	REC93210-46044	93210-46044-00	ANILLO, BASE	O-RING	O-RING	JOINT TORIQUE
39	REC688-44316-00	688-44316-A0-00	JUNTA, BASE	GASKET	GUARNIZIONE	JOINT
40	REC688-44341-01	688-44341-01-94	BASE, BOMBA AGUA	HOUSING WATER PUMP	BASE POMPA ACQUA	BASE DE POMPE À EAU
41	REC688-44324-00	688-44324-A0-00	JUNTA	GASKET	GUARNIZIONE	JOINT
42	REC688-44323-00	688-44323-00-00	PLATO	PLATE	PIASTRA	PLAQUE DE POMPE À EAU
43	REC688-44315-00	688-44315-A0-00	JUNTA	GASKET	GUARNIZIONE	JOINT
44	REC688-44352-03	688-44352-03-00	TURBINA	IMPELLER	GIRANTE	TURBINE
45	REC688-44322-00	688-44322-00-00	ACOPLAMIENTO INOX.	INSERT	BOCCOLA INOX.	INSERT DE POMPE À EAU
46	REC688-44311-01	688-44311-01-00	CUERPO BOMBA AGUA	HOUSING	CORPO POMA ACQUA	CORPS DE POMPE À EAU
47	REC97395-08070	97395-08070-00	TORNILLO	BOLT	VITE	VIS
48	REC663-44366-00	663-44366-00	RETÉN	SEAL	PARAOLIO	BAGUE
49	REC90430-12072	90430-12072-00	JUNTA	GASKET	GUARNIZIONE	JOINT

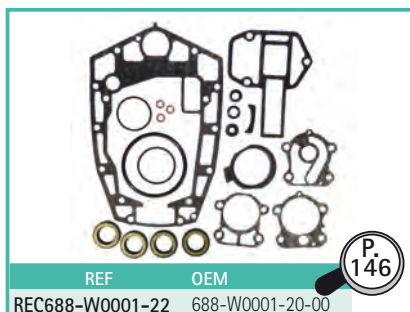



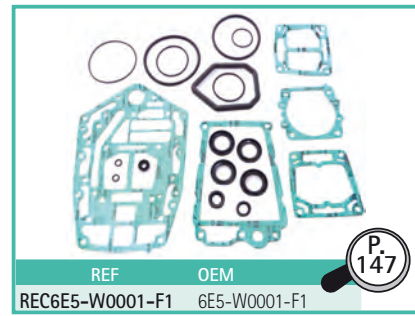
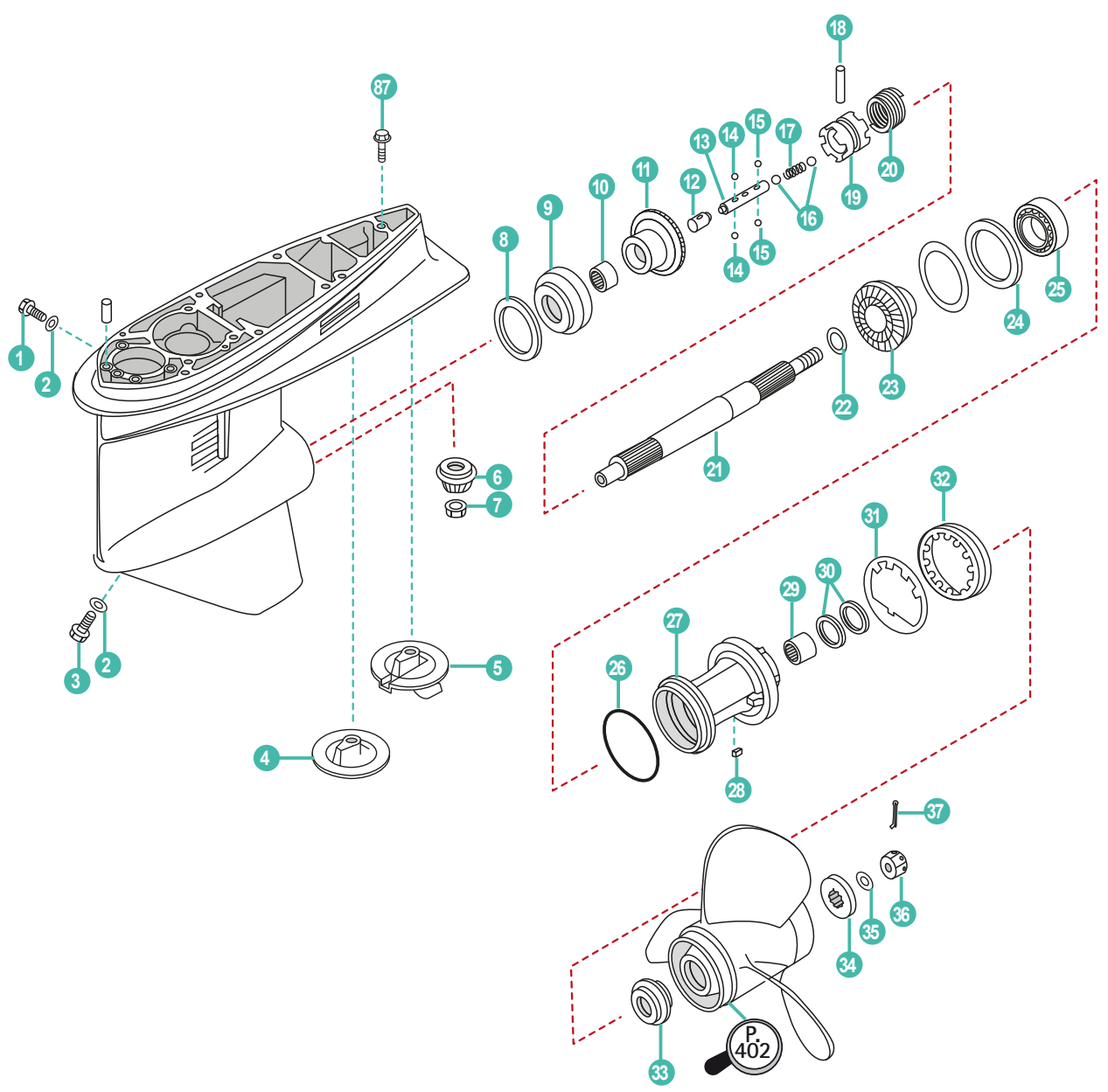

	REF	OEM				
	REC405-A20	6E5-45300-16-8D	COLA COMPLETA	LOWER UNIT ASSY	PIEDE COMPLETO	EMBASE COMPLETE
	REC405-A25	6E5-45300-26-8D	COLA COMPLETA	LOWER UNIT ASSY	PIEDE COMPLETO	EMBASE COMPLETE
1	REC90340-08002	90340-08M04	TAPÓN	PLUG, STRAIGHT SCREW	TAPPO	BOUCHON DE VIDANGE
2	REC90430-08020	90430-08020	JUNTA	GASKET	GUARNIZIONE	JOINT
3	REC688-45341-00	688-45341-00	TAPÓN	PLUG DRAIN	TAPPO	BOUCHON DE VIDANGE
4	REC6E5-45371-01	6E5-45371-01	ZINC HÉLICE ALU	TAB-TRIM	ZINCO ELICA ALLU.	ANODE
5	TEN01153	6E5-45371-10	ZINC HÉLICE INOX	TAB-TRIM	ZINCO ELICA INOX.	ANODE
6	REC6E5-45551-00	6E5-45551-02	PIÑÓN ATAQUE	INITIATIVE GEAR	MARCIA INIZIATIVA	PIGNON D'ATTAQUE
7	REC90170-16M01	90170-16M01	TUERCA	NUT	DADO	ECROU
8	REC6E5-45567-01	6E5-45567-01-60	KIT GRUESO	SHIM SET	KIT SPESSORE	KIT CALE
9	REC93332-000U7	93332-000U7	RODAMIENTO	BEARING	CUSCINETTO	ROULEMENT
10	REC93315-425U7	93315-425U7	RODAMIENTO	BEARING	CUSCINETTO	ROULEMENT
11	REC6E5-45560-00	6E5-45560-01	PIÑÓN MARCHA AVANTE	POSITIVE GEAR ASSY	PIGNONE MARCIA AVANTI	PIGNON DE MARCHE AVANT
12	REC6E5-45641-03	6E5-45641-02	BULÓN	SHIFTER	BULLONE	PISTON
13	REC6E5-45634-01	6E5-45634-01	PASADOR DESPLAZABLE	SLIDE, SHIFT	PASSANTE	DOUILLE
14	REC93507-32031	93507-32031	BOLA	BALL	BOLLA	BILLE
15	REC93503-16003	93503-16003	BOLA	BALL	BOLLA	BILLE
16	REC93511-32027	93511-32027	BOLA	BALL	BOLLA	BILLE
17	REC90501-16M37	90501-16M37	MUELLE	SPRING, COMPRESSION	MOLLA	RESSORT
18	REC90250-08M07	90250-08M07	PASADOR	PIN STRAIGHT	SPINOTTO	PIN
19	REC6E5-45631-00	6E5-45631-01	DESPLAZABLE	CLUTCH, DOG	SCORREVOLE	CRABOT
20	REC6E5-45633-01	6E5-45633-01	ARILLO METÁLICO	RING, CROSS PIN	O-RING	JOINT TORIQUE
21	REC6E5-45611-00	6E5-45611-01	EJE HÉLICE	SHAFT, PROPELLER	ASSE ELICA	ARBRE D'HELICE
22	REC90201-30M92	90201-30M92	ARANDELA	WASHER, PLATE	RONDELLA	RONDELLE
23	REC6E5-45570-00	6E5-45571-01	PIÑÓN MARCHA ATRÁS	REVERSE GEAR	PIGNONE MARCIA INDIETRO	PIGNON MARCHE ARRIÈRE
24	REC6E5-45576-00	6E5-45576-00	ARANDELA	WASHER, THURST	RONDELLA	RONDELLE
25	REC93306-208U0	93306-208U0	RODAMIENTO	BEARING	CUSCINETTO	ROULEMENT
26	REC93210-86M39	93210-86M39	ARO TÓRICO	O-RING	O-RING	JOINT TORIQUE
27	REC6E5-45332-00-94	6E5-45332-00-94	CUERPO COJINETE	HOUSING, BEARING	CUSCINETTO	DIABOLO
28	REC90282-04010	90282-04010	CHAVETA	KEY, STRAIGHT	CHIAVETTA	CLAVETTE
29	REC93315-430U8	93315-430U8	RODAMIENTO	BEARING	CUSCINETTO	ROULEMENT
30	REC93101-30M17	93101-30M17	RETÉN	OIL SEAL	PARAOLIO	JOINT SPI
31	REC688-45383-01	688-45383-02	ARANDELA	WASHER, CLAW	RONDELLA	RONDELLE
32	REC688-45384-00	688-45384-00	TUERCA	NUT	DADO	ECROU
33	REC6E5-45987-00	6E5-45987-01	SEPARADOR	SPACER	SPESSORE	ENTRETOISE
34	REC688-45997-00	688-45997-01	SEPARADOR	SPACER	SPESSORE	ENTRETOISE
35	REC92990-18200	92990-18200	ARANDELA	WASHER	RONDELLA	RONDELLE
36	REC90171-18M04	90171-18M04	TUERCA HÉLICE	NUT, CASTLE	DADO	ECROU D'HELICE
37	REC91490-40030	91490-40030	PASADOR ALETA	PIN, COTTER	SPINOTTO	GOUPILLE
38	PAT85-00000012	90105-10M00	TORNILLO	SCREW	VITE	VIS

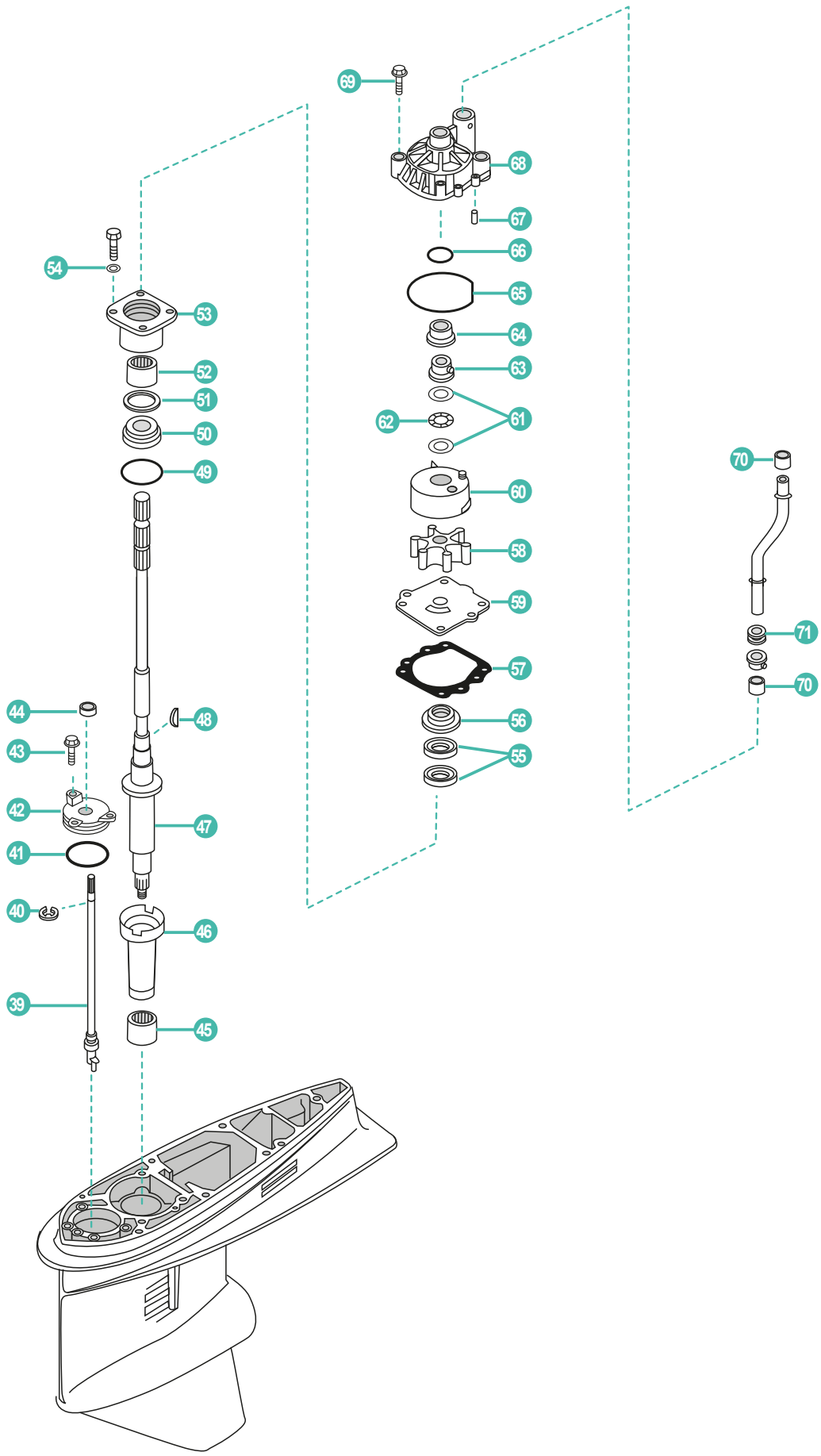

	REF	OEM				
39	REC6E5-44150-02	6E5-44150-01	EJE SELECTOR	SHIFT CAM ASSY.	ASSE SELETTORE	ARBRE SELECTEUR
40	REC99001-08600-00	99001-08600	CLIP	CLIP	CLIP	CLIP
41	REC93210-58677	93210-58144	ARO TÓRICO	O-RING	O-RING	JOINT TORIQUE
42	REC6E5-45321-00	6E5-45321-00	PLATO	PLATE	PIASTRA	PLAQUE
43	REC90119-06M10	90119-06M10	TORNILLO	BOLT WITH WASHER	VITE	VIS
44	REC93106-09014	93106-09014	RETÉN	OIL SEAL	PARAOLIO	JOINT SPI
45	REC93315-628U9	93315-628U9	RODAMIENTO	BEARING	CUSCINETTO	ROULEMENT
46	REC6E5-45536-00	6E5-45536-00	CAMISA	SLEEVE	CAMICIA	TUBE GUIDE
47	REC6E5-45501-01	6E5-45501-01	EJE VERTICAL S	DRIVE SHAFT COMP. S	ASSE VERTICALE S	ARBRE VERTICAL S
48	REC90280-04M05	90280-04M05	CHAVETA	KEY, WOODRUF	CHIAVETTA	CLAVETTE
49	REC93210-54534	93210-55M14	ARO TÓRICO	O-RING	O-RING	JOINT TORIQUE
50	REC93341-930V2	93341-930V2	RODAMIENTO	BEARING	CUSCINETTO	ROULEMENT
51	REC6E5-45587-01	6E5-45587-01	GRUESO	SHIM	SPESSORE	CALE
52	REC93317-330U2	93317-330U2	RODAMIENTO	BEARING	CUSCINETTO	ROULEMENT
53	REC6E5-45331-00-94	6E5-45331-00-94	CUERPO RODAMIENTO	HOUSING, BEARING	SEDE CUSCINETTO	PALIER DE ROULEMENT
54	PAGB/T97.1-8	92995-08600	ARANDELA	WASHER	RONDELLA	RONDELLE
55	REC93101-28M16	93101-28M16	RETÉN	OIL SEAL	PARAOLIO	JOINT SPI
56	REC6E5-45344-00	6E5-45344-00	TAPA RETÉN	COVER, OIL SEAL	COPERCHIO	COUVERCLE JOINT SPI
57	REC6E5-44315-A0	6E5-44315-A0	JUNTA BOMBA	GASKET, WATER PUMP	GUARNIZIONE	JOINT
58	REC6E5-44323-00-40	6E5-44323-00	PLATO	OUTTER PLATE, CARTRIDGE	PIASTRA	TURBINE
59	REC6E5-44352-01	6E5-44352-01	TURBINA	IMPELLER	GIRANTE	PLAQUE DE POMPE À EAU
60	REC61A-44322-02	61A-44322-02	CASQUILLO INOX	INSERT, CARTRIDGE	BOCCOLA INOX.	INSERT DE POMPE À EAU
61	REC90201-22M01	90201-22M01	ARANDELA	WASHER	RONDELLA	RONDELLE
62	REC90206-22M19	90206-22M19	ARANDELA	WASHER	RONDELLA	RONDELLE
63	REC61A-45538-00	61A-45538-00	ESPACIADOR	SPACER	DISTANZIALE	ENTRETOISE
64	REC61A-45527-00	61A-45527-00	CASQUILLO	COLLAR, DRIVE SHAFT	BOCCOLA	GUIDE
65	REC93210-86M38	93210-86M38	ARO TÓRICO	O-RING	O-RING	JOINT TORIQUE
66	REC93210-37160	93210-37160	ARO TÓRICO	O-RING	O-RING	JOINT TORIQUE
67	REC93606-12019	93606-12019	PIN CENTRADOR	PIN DOWEL	SPINOTTO	PIN
68	REC61A-44311-00	61A-44311-01	CUERPO BOMBA	HOUSING, WATER PUMP	CORPO POMPA	CORPS DE POMPE À EAU
69	REC90119-08M14	90119-08M14	TORNILLO	BOLT, WITH WASHER	VITE	VIS
70	REC6E5-44365-00	6E5-44365-00	CASQUILLO GOMA	DAMPER	BOCCOLA	BAGUE
71	REC6E5-44366-00	6E5-44366-00	CASQUILLO GOMA	DAMPER	BOCCOLA	BAGUE



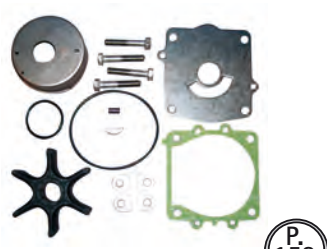
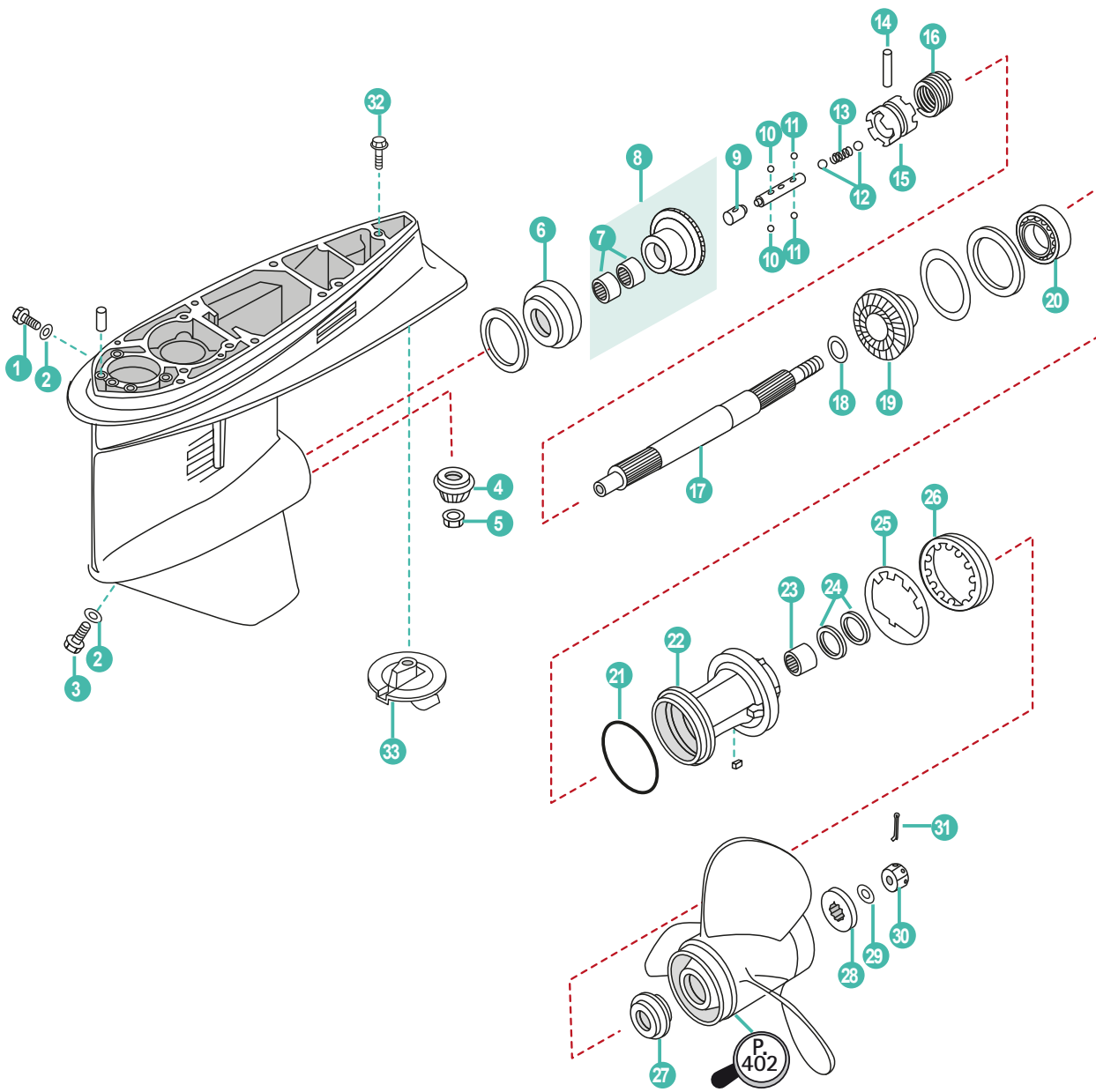

REF	OEM
REC6G5-W0078-A1	6G5-W0078-A1

P. 152

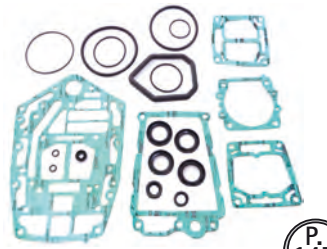

REF	OEM
REC6E5-W0001-F1	6E5-W0001-F1

P. 147



REF
REC80W90U3
REC80W90U6
RECGREU1
RECGREU12

P. 43

	REF	OEM				
	REC416-A20	64D-45300-02-8D	COLA COMPLETA 20"	LOWER UNIT ASSY 20"	PIEDE COMPLETO 20"	EMBASE COMPLETE 20"
	REC416-A25	64D-45300-22-8D	COLA COMPLETA 25"	LOWER UNIT ASSY 25"	PIEDE COMPLETO 25"	EMBASE COMPLETE 25"
1	REC90340-08002	90340-08002	TAPÓN	PLUG, STRAIGHT SCREW	TAPPO	BOUCHON DE VIDANGE
2	REC90430-08020	90430-08020	JUNTA	GASKET	GUARNIZIONE	JOINT
3	REC688-45341-00	688-45341-10	TAPÓN	PLUG, DRAIN	TAPPO	BOUCHON DE VIDANGE
4	REC6G5-45551-00	6G5-45551-01	PIÑÓN ATAQUE	INITIATIVE GEAR	MARCIA INIZIATIVA	PIGNON D'ATTAQUE
5	REC90170-16M01	93170-16M01	TUERCA	NUT	DADO	ECROU
6	REC93332-000V3	93332-000V3	RODAMIENTO	BEARING	CUSCINETTO	ROULEMENT
7	REC93315-425V3	93315-425V3	RODAMIENTO	BEARING	CUSCINETTO	ROULEMENT
8	REC6G5-45560-00	6G5-45560-01	PIÑÓN MARCHA AVANTE	POSITIVE GEAR ASSY	PIGNONE MARCIA AVANTI	PIGNON DE MARCHÉ AVANT
9	REC6E5-45641-03	6E5-45641-03	PITOT	PITOT	PITOT	PITOT
10	REC93507-32031	93507-32031	BOLA	BALL	BOLLA	BILLE
11	REC93503-16003	93503-16003	BOLA	BALL	BOLLA	BILLE
12	REC93511-32027	93511-32027	BOLA	BALL	BOLLA	BILLE
13	REC90501-16M37	90501-16M37	MUELLE	SPRING	MOLLA	RESSORT
14	REC90250-08M07	90250-08M07	PASADOR	PIN, STRAIGHT	SPINOTTO	CLAVETTE
15	REC6G5-45631-00	6G5-45631-00	DESPLAZABLE	CLUTCH, DOG	SCORREVOLE	CRABOT
16	REC6E5-45633-01	6E5-45633-01	ANILLO	RING, CROSS PIN	O-RING	JOINT TORIQUE
17	REC6J9-45611-00	6J9-45611-01	EJE HÉLICE	SHAFT, PROPELLER	ASSE ELICA	ARBRE D'HELICE
18	REC90201-30M92	90201-30M92	ARANDELA	WASHER, PLATE	RONDELLA	RONDELLE
19	REC6G5-45571-00	6G5-45571-02	PIÑÓN MARCHA ATRÁS	REVERSE GEAR	PIGNONE MARCIA INDIETRO	PIGNON MARCHÉ ARRIÈRE
20	REC93306-209U0	93306-209U0	RODAMIENTO	BEARING	CUSCINETTO	ROULEMENT
21	REC93210-97M55	93210-97M55	ARO TÓRICO	O-RING	O-RING	JOINT TORIQUE
22	REC6J9-45332-00-CA	6J9-45332-00-CA	DIÁBOLO	BEARING CARRIER	COP. CASSA INGRANAGGI	DIABOLO
23	REC93315-43061	93315-43061	RODAMIENTO	BEARING	CUSCINETTO	ROULEMENT
24	REC93101-30M17	93101-30M17	RETÉN	OIL SEAL	PARAOLIO	JOINT SPI
25	REC6G5-45383-01	6G5-45383-01	ARANDELA	WASHER, CLAW	RONDELLA	RONDELLE
26	REC6G5-45384-00	6G5-45384-00	TUERCA	NUT	DADO	ECROU
27	REC6E5-45987-00	6E5-45987-01	ESPACIADOR	SPACER	DISTANZIALE	ENTRETOISE
28	REC688-45997-00	688-45997-01	ESPACIADOR	SPACER	DISTANZIALE	ENTRETOISE
29	REC92990-18200	92990-18200	ARANDELA	WASHER	RONDELLA	RONDELLE
30	REC90171-18M04	90171-18M04	TUERCA	NUT, CASTLE	DADO	ECROU D'HELICE
31	REC91490-40030	91490-40030	PASADOR	PIN, COTTER	SPINOTTO	GOUPILLE
32	PAT85-00000012	90105-10M00	TORNILLO	SCREW	VITE	VIS
33	CM6E5-45371-01A	6E5-45371-01	ÁNODO	ANODE	ANODO	ANODE

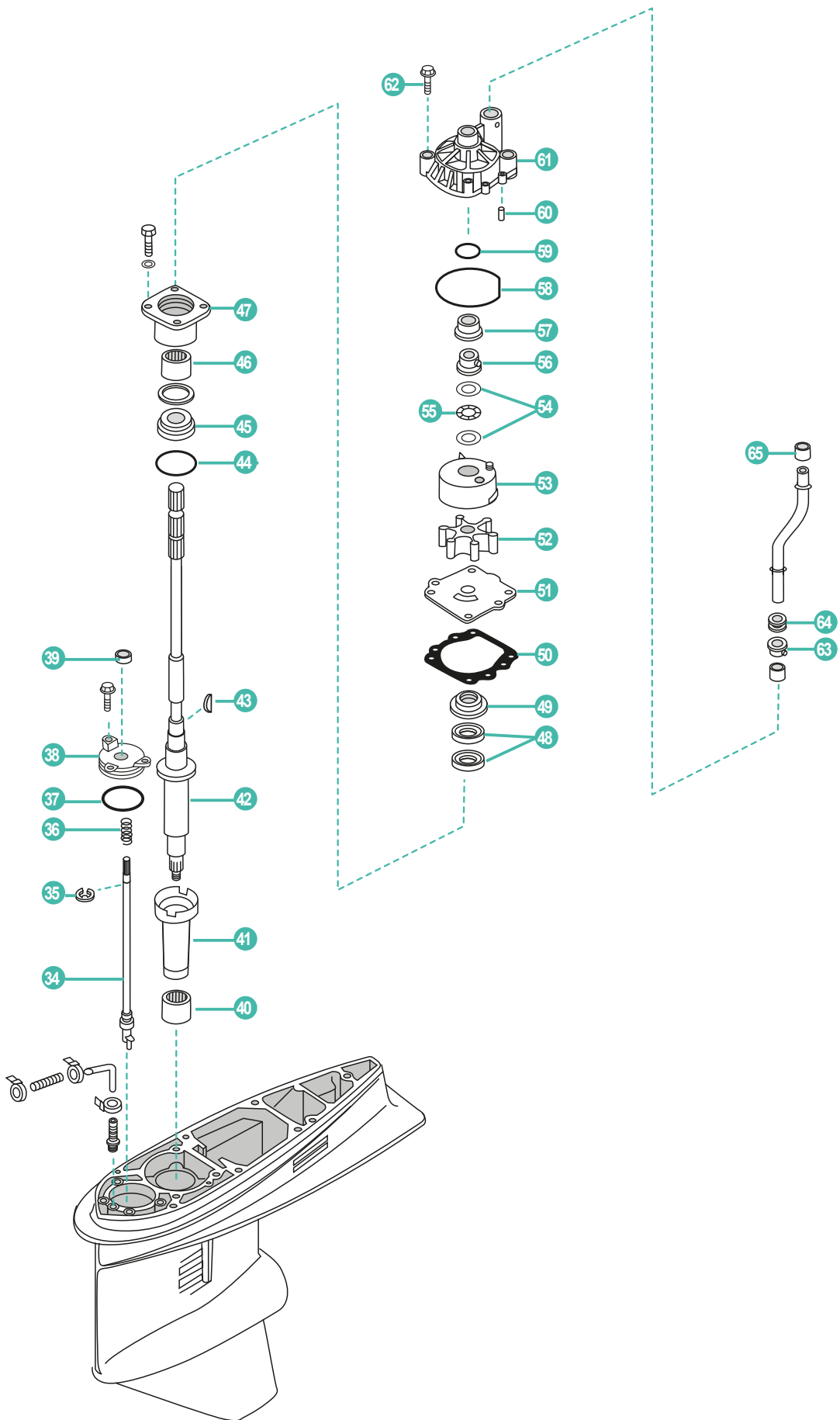

	REF	OEM				
34	REC6G5-44150-02	6G5-44150-02	EJE CAMBIO	SHIFT SHAFT	ASSE CAMBIO	LEVIER DE VITESSE
35	REC99001-08600-00	99001-08600	CLIP	BEARING	CUSCINETTO	ROULEMENT
36	REC90501-11M10-00	90501-11M10	MUELLE	SPRING	MOLLA	RESSORT
37	REC93210-58677	93210-58144	ARO TÓRICO	O-RING	O-RING	JOINT TORIQUE
38	REC6E5-45321-00	6E5-45321-00	TAPA EJE	SHIFT COVER	COPERCHIO ASSE	COUVERCLE
39	REC93106-09014	93106-09014	RETÉN	OIL SEAL	PARAOLIO	JOINT SPI
40	REC93311-928U5	93311-928U5	RODAMIENTO	BEARING	CUSCINETTO	ROULEMENT
41	REC6G5-45536-01	6G5-45536-01	CAMISA	LUBE SLEEVE	CAMICIA	DOUILLE
42	REC6G5-45501-21	6G5-45501-21	EJE 25"	DRIVE SHAFT COMP. 25"	ASSE VERTICALE 25"	ARBRE VERTICAL 25"
43	REC90280-04M05	90280-04M05	CHAVETA	KEY, WOODRUFF	CHIAVETTA	CLAVETTE
44	REC93210-54534	93210-55M14	ARO TÓRICO	O-RING	O-RING	JOINT TORIQUE
45	REC93341-930V2	93341-930V2	RODAMIENTO	BEARING	CUSCINETTO	ROULEMENT
46	REC93317-330U2	93317-330U2	RODAMIENTO	BEARING	CUSCINETTO	ROULEMENT
47	REC6E5-45331-00-94	6E5-45331-00-94	CUERPO RODAMIENTO	HOUSING, BEARING	SEDE CUSCINETTO	PALIER DE ROULEMENT
48	REC93101-28M16	93101-28M16	RETÉN	OIL SEAL	PARAOLIO	JOINT SPI
49	REC6E5-45344-00	6E5-45344-00	TAPA RETÉN	COVER, OIL SEAL	COPERCHIO	COUVERCLE JOINT SPI
50	REC6E5-44315-A0	6E5-44315-A0	JUNTA	GASKET, WATER PUMP	GUARNIZIONE	JOINT DE POMPE À EAU
51	REC6G5-44323-00	6G5-44323-00	PLATO	OUTER PLATE, CARTRIDGE	PIASTRA	PLAQUE DE POMPE À EAU
52	REC6E5-44352-01	6E5-44352-01	TURBINA	IMPELLER	GIRANTE	TURBINE
53	REC61A-44322-02	61A-44322-02	CASQUILLO INOX. -ANTIGUA-	INSERT, CARTRIDGE -OLDER-	BOCCOLA INOX. -ANTICA-	INSERT DE POMPE À EAU -ANCIEN MODÈLE-
	REC6E5-44322-00	6E5-44322-00	CASQUILLO INOX. -MODERNA-	INSERT, CARTRIDGE -NEWER-	BOCCOLA INOX. -NUOVA-	INSERT DE POMPE À EAU -NOUVEAU MODÈLE-
54	REC90206-22M19	90206-22M19	ARANDELA	WASHER	RONDELLA	RONDELLE
55	REC90201-22M01	90201-22M01	ARANDELA	WASHER	RONDELLA	RONDELLE
56	REC61A-45538-00	61A-45538-00	ESPACIADOR	SPACER	DISTANZIALE	ENTRETOISE
57	REC61A-45527-00	61A-45527-00	GOMA	COLLAR	GOMMA	BAGUE
58	REC93210-86M38	93210-86M38	ARO TÓRICO	O-RING	O-RING	JOINT TORIQUE
59	REC93210-37160	93210-37160	ARO TÓRICO	O-RING	O-RING	JOINT TORIQUE
60	REC93606-12019	93606-12019	CENTRADOR	PIN, DOWEL	SPINOTTO	PIN
61	REC61A-44311-00	61A-44311-01	CUERPO BOMBA AGUA -ANTIGUA-	HOUSTING, WATER PUMP -OLDER-	CORPO POMPA ACQUA -ANTICA-	CORPS DE POMPE À EAU -ANCIEN MODÈLE-
	REC6E5-44311-00	6E5-44311-00	CUERPO BOMBA AGUA -MODERNA-	HOUSTING, WATER PUMP -NEWER-	CORPO POMPA ACQUA -NUOVA-	CORPS DE POMPE À EAU -NOUVEAU MODÈLE-
62	REC90119-08M14	90119-08M14	TORNILLO	BOLT, WITH WASHER	VITE	VIS
63	REC6E5-44365-00	6E5-44365-00	CASQUILLO GOMA	DAMPER, WATER SEAL	BOCCOLA GOMMA	BAGUE
64	REC6E5-44366-00	6E5-44366-00	SELLO GOMA AGUA	DAMPER, WATER SEAL	BOCCOLA	BAGUE
65	REC6E5-44365-00	6E5-44365-00	SELLO GOMA AGUA	DAMPER, WATER SEAL	BOCCOLA	BAGUE



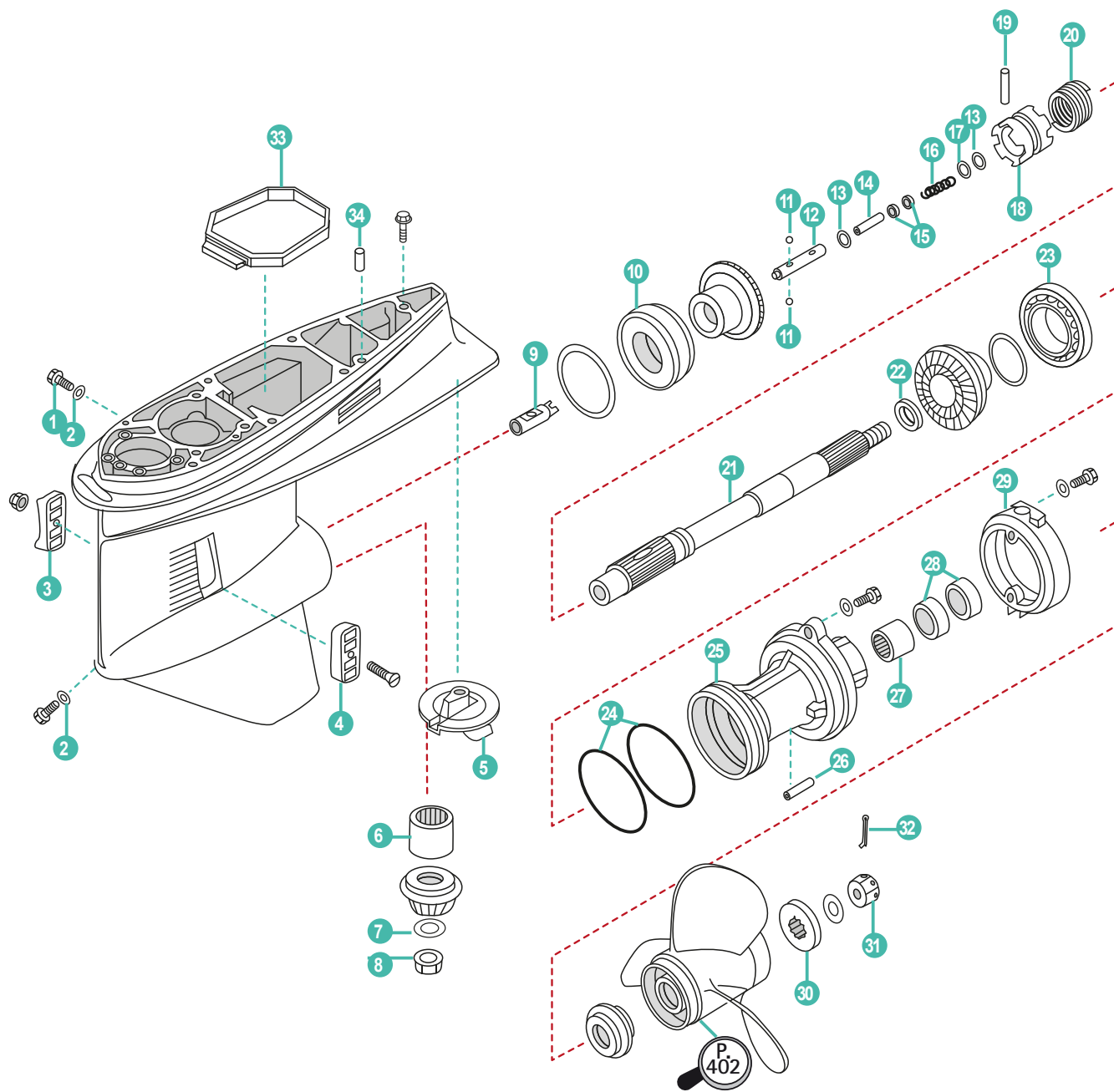

	REF	OEM				
1	REC90340-08002	90340-08002	TORNILLO	VENT PLUG	VITE	BOUCHON DE VIDANGE
2	REC90430-08020	90430-08020	JUNTA	GASKET, DRAIN PLUG	GUARNIZIONE	JOINT
3	REC61A-45215-10	61A-45215-10	FILTRO TAPA	WATER SCREEN, STD	COPERCHIO FILTRO	GRILLE D'ENTREE D'EAU
4	REC61A-45214-10	61A-45214-10	FILTRO TAPA	WATER SCREEN, PORT	COPERCHIO FILTRO	GRILLE D'ENTREE D'EAU
5	CM61A-45371	61A-45371-00	ÁNODO TIMÓN	TRIM TAB	ANODO	ANODE
6	REC93311-83280	93311-83280	RODAMIENTO	BEARING	CUSCINETTO	ROULEMENT
7	REC90201-16M00	90201-16M00	ARANDELA	WASHER	RONDELLA	RONDELLE
8	REC90170-16M19	90170-16M19	TUERCA DE PIÑÓN	PINION NUT	PIGNONE, DADO	ECROU DE PIGNON
9	REC61A-45641-02	61A-45641-02	DESPLAZABLE	SHIFTER	SCORREVOLE	DOUILLE
10	REC93332-000W1	93332-000W1	RODAMIENTO	BEARING	CUSCINETTO	ROULEMENT
11	REC93501-04011	93501-04011	BOLA	DETENT BALL	BOLLA	BILLE
12	REC61A-45634-01	61A-45634-01	DESPLAZABLE	SHIFT SLIDE	SCORREVOLE	DOUILLE
13	REC90183-02M03	90183-02M03	TUERCA	NUT	DADO	ECROU
14	REC6H1-45668-00	6H1-45668-00	EJE	FREE SHAFT	ASSE	ARBRE
15	REC61A-45635-00	61A-45635-00	GRUESO	SHIFT PLUNGER	SPESSORE	CALE
16	REC90501-10M77	90501-10M77	MUELLE	COMPRESSION SPRING	MOLLA	RESSORT
17	REC90201-02M00	90201-02M00	ARANDELA	PLATE WASHER	RONDELLA	RONDELLE
18	REC61A-45631-03	61A-45631-03	SELECTOR	CLUTCH, 2 STROKE	SELETTORE	CRABOT
19	REC61A-45632-00	61A-45632-00	PASADOR	CROSS PIN	SPINOTTO	CLAVETTE
20	REC61A-45633-00	61A-45633-00	MUELLE	SPRING	MOLLA	RESSORT
21	REC60V-45611-00	60V-45611-00	EJE HÉLICE	PROP SHAFT	ASSE ELICA	ARBRE D'HELICE
22	REC90201-31M00	90201-31M00	ARANDELA	WASHER	RONDELLA	RONDELLE
23	REC93306-210U0	93306-210U0	RODAMIENTO	BEARING	CUSCINETTO	PIGNON
24	REC93211-04384	93211-04384	ARO TÓRICO	O-RING, BEARING CARRIER	O-RING	JOINT TORIQUE
25	REC60V-45332-00-94	60V-45332-00-94	DIÁBOLO	BEARING CARRIER	COP. CASSA INGRANAGGI	DIABOLO
26	REC99590-10114	99590-10114	PIN CENTRADO	ALIGNMENT DOWEL	SPINOTTO	PIN ROULEMENT
27	REC93315-43061	93315-43061	RODAMIENTO	PROP SHAFT BEARING	CUSCINETTO	ROULEMENT
28	REC93101-30M17	93101-30M17	RETÉN	PROP SHAFT SEAL	PARAOILIO	JOINT SPI
29	REC69J-45361-00-8D	69J-45361-00-8D	FUNDA INFERIOR	CAP, LOWER CASING	COPERCHIO INFERIORE	COUVERCLE INFERIEUR
30	REC688-45997-00	688-45997-00	ESPACIADOR	SPACER	SPESSORE	ENTRETOISE
31	REC90171-18M04	90171-18M04	TUERCA	PROP NUT	DADO	ECROU D'HELICE
32	REC91490-40030	91490-40030	PIN	COTTER PIN	SPINOTTO	GOUPILLE
33	REC69J-45375-00	69J-45375-00	JUNTA ESCAPE	EXHAUST DAMPER	GUARNIZIONE1	JOINT D'ECHAPPEMENT
34	REC93608-12M05	93608-12M05	PIN	ALIGNMENT DOWELS	SPINOTTO	PIN

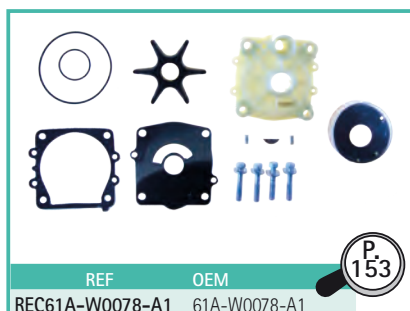

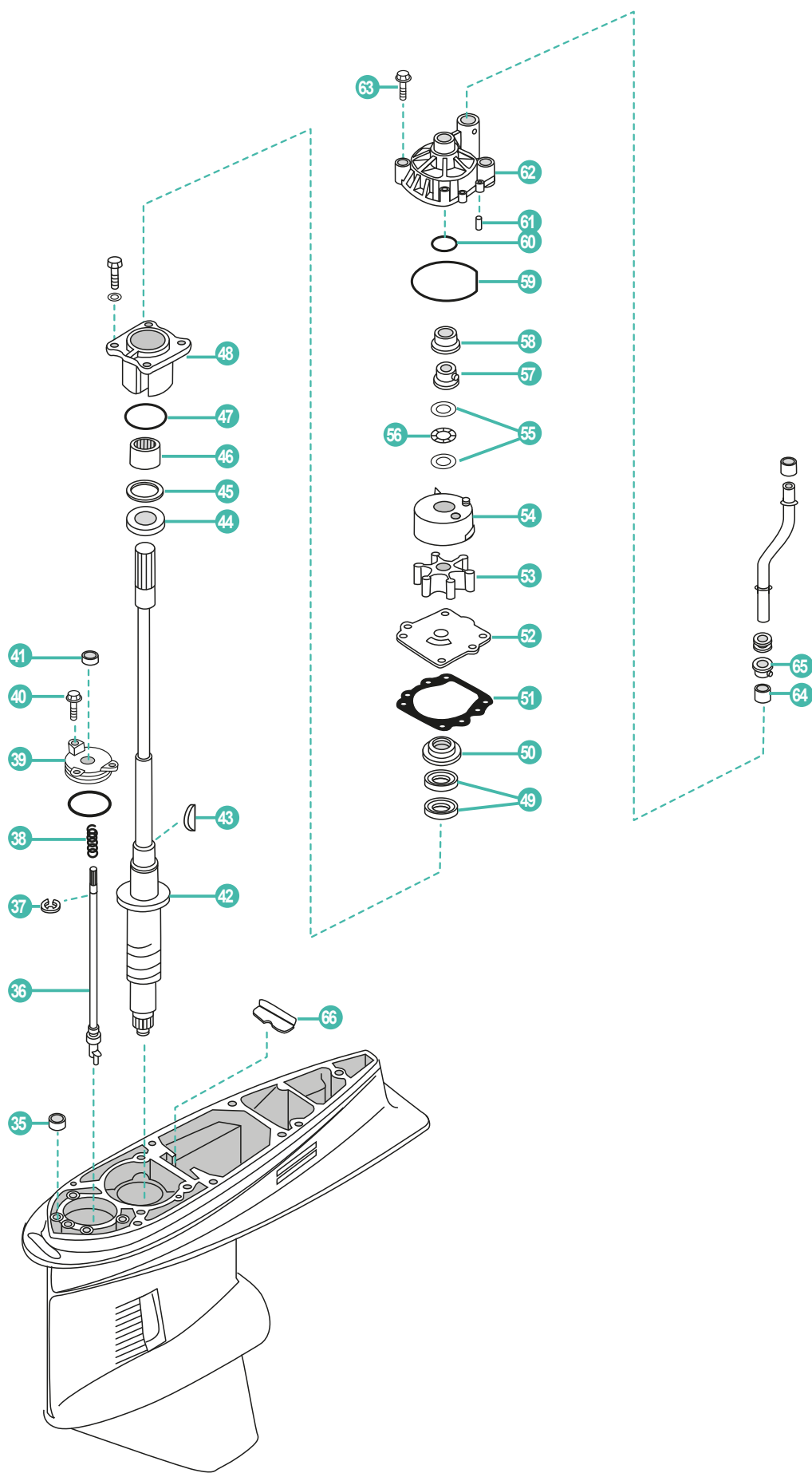

	REF	OEM				
35	REC663-44366-00	663-44366-00	GOMA	SEAL	GOMMA	BAGUE
36	REC60V-44150-00	60V-44150-00	EJE	SHIFT SHAFT	ASSE	LEVIER DE VITESSE
37	REC99001-08600-00	99001-08600	CLIP	CLIP	CLIP	CLAVETTE
38	REC90501-11M10-00	90501-11M10	MUELLE	SPRING	MOLLA	RESSORT
39	REC61A-45321-01	61A-45321-01	TAPA	SHIFT SHAFT COVER	COPERCHIO ASSE	COUVERCLE
40	REC90119-06M10	90119-06M10	TORNILLO	BOLT	VITE	VIS
41	REC93106-09014	93106-09014	RETÉN	SEAL, SHIFT ROD	BOCCOLA	JOINT
	REC66K-45501-00	66K-45501-00	EJE 20"	DRIVE SHAFT, 20"	ASSE VERTICALE 20"	ARBRE VERTICAL 20"
42	REC61A-45501-20	61A-45501-20	EJE 25"	DRIVE SHAFT, 25"	ASSE VERTICALE 25"	ARBRE VERTICAL 25"
	REC61A-45501-30	61A-45501-30	EJE 30"	DRIVE SHAFT, 30"	ASSE VERTICALE 30"	ARBRE VERTICAL 30"
43	REC90280-04M05	90280-04M05	CHAVETA	WOODRUFF KEY	CHIAVETTA	CLAVETTE
44	REC93341-93020	93341-93020	GRUESO RODAMIENTO	THRUST BEARING	SPESSORE CUSCINETTO	CALE
45	REC61A-45587-00/60-0	61A-45587-00/60	ESPACIADOR	SHIM KIT	SPESSORE	ENTRETOISE
46	REC93317-330U2	93317-330U2	RODAMIENTO	BEARING	CUSCINETTO	ROULEMENT
47	REC93210-54534	93210-54534	ARO TÓRICO	O-RING	O-RING	JOINT TORIQUE
48	REC61A-45331-00-94	61A-45331-00-94	CUERPO EJE	DRIVE SHAFT BEARING HOUSING	CORPO ASSE	PALIER DE ROULEMENT
49	REC93101-28M16	93101-28M16	RETÉN	DRIVE SHAFT SEAL	BOCCOLA	JOINT SPI
50	REC6E5-45344-00	6E5-45344-00	RETÉN	COVER, DRIVE SHAFT SEALS	BOCCOLA	COUVERCLE DE JOINT SPI
51	REC6E5-44315-A0	6E5-44315-A0	JUNTA BASE	BASE GASKET	GUARNIZIONE	JOINT
52	REC6G5-44323-00	6G5-44323-00	BASE BOMBA	WEAR PLATE	BASE POMPA	PLAQUE DE POMPE À EAU
53	REC6E5-44352-01	6E5-44352-01	TURBINA	IMPELLER	GIRANTE	TURBINE
54	REC61A-44322-02	61A-44322-02	CASQUILLO INOX.	WATER PUMP LINER	BOCCOLA	INSERT DE POMPE À EAU
55	REC90201-22M01	90201-22M01	ARANDELA	WASHER	RONDELLA	RONDELLE
56	REC90206-22M19	90206-22M19	TÓRICA	WAVE WASHER	GUARNIZIONE	JOINT TORIQUE
57	REC61A-45538-00	61A-45538-00	ESPACIADOR	SPACER	DISTANZIALE	ENTRETOISE
58	REC61A-45527-00	61A-45527-00	COLLAR	COLLAR	COLLAR	BAGUE
59	REC93210-86M38	93210-86M38	ARO TÓRICO	O-RING	O-RING	JOINT TORIQUE
60	REC93210-37M67	93210-37M67	ARO TÓRICO	O-RING	O-RING	JOINT TORIQUE
61	REC93606-12019	93606-12019	PASADOR CENTRAL	ALIGNMENT PIN	SPINOTTO	PIN
62	REC61A-44311-00	61A-44311-00	CUERPO BOMBA AGUA	WATER PUMP HOUSING	CORPO POMPA ACQUA	CORPS DE POMPE À EAU
63	REC90119-08M14	90119-08M14	TORNILLO CON ARANDELA	BOLT WITH WASHER	VITE	VIS
64	REC6E5-44365-00	6E5-44365-00	CASQUILLO JUNTA	DAMPER, WATER TUBE	BOCCOLA TUBO	BAGUE
65	REC6E5-44312-00	6E5-44312-00	TAPA	OVER	TAPPO	BAGUE
66	REC61A-45376-00-94	61A-45376-00-94	GUÍA	GUIDE	GUIDE	GUIDE



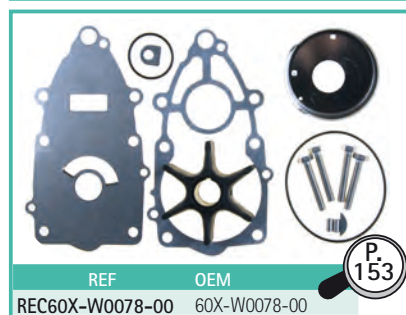
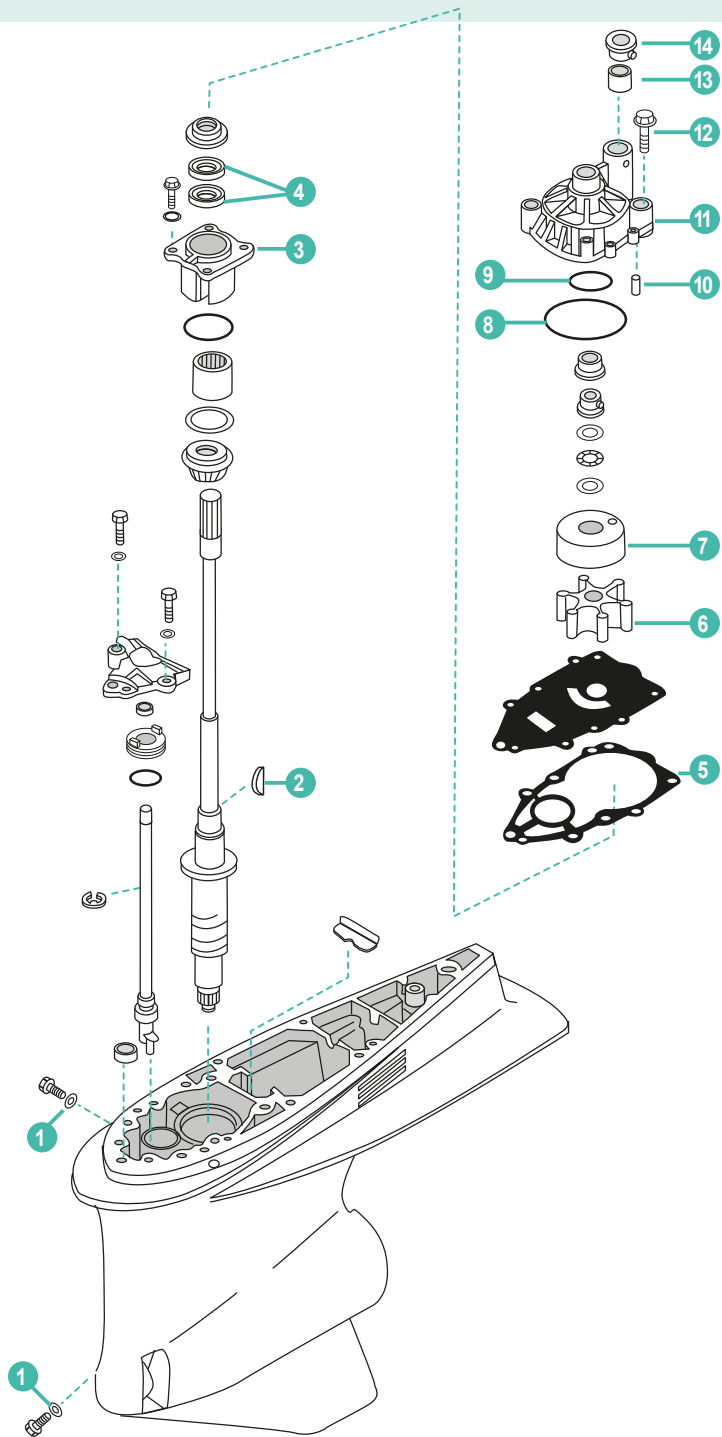

	REF	OEM				
1	REC90430-08020	93430-08020	JUNTA	GASKET, DRAIN FILL	GUARNIZIONE	JOINT
2	REC90280-04M05	90280-04M05	CHAVETA	KEY, WOODRUFF	CHIAVETTA	CLAVETTE
3	REC61A-45331-00-94	61A-45331-00-94	CUERPO COJINETE EJE	DRIVE SHAFT BEARING HOUSING	CORPO CUSCINETTO	PALIER DE ROULEMENT
4	REC93101-28M16	93101-28M16	RETÉN	OIL SEAL	PARAOILIO	JOINT SPI
5	REC60X-44315-A0	60X-44315-A0	JUNTA	GASKET	GUARNIZIONE	JOINT
6	REC6E5-44352-01	6E5-44352-01	IMPULSOR	IMPELLER	GIRANTE	TURBINE
7	REC61A-44322-02	61A-44322-02	CASQUILLO INOX.	PUMP CUP	BOCCOLA INOX.	INSERT DE POMPE À EAU
8	REC93210-86M38	93210-86M38	ARO TÓRICO	O-RING	O-RING	JOINT TORIQUE
9	REC93210-37M67	93210-37M67	ARO TÓRICO	O-RING	O-RING	JOINT TORIQUE
10	REC93606-12019	93606-42019	PASADOR	PIN, DOWELL	SPINOTTO	PIN
11	REC61A-44311-00	61A-44311-01	CUERPO BOMBA AGUA	WATER PUMP HOUSING	CORPO POMPA ACQUA	CORPS DE POMPE À EAU
12	REC90119-08M14	90119-08M14	TORNILLO CON ARANDELA	BOLT W WASHER	VITE	VIS
13	REC6E5-44365-00	6E5-44365-00	CASQUILLO GOMA	DAMPER	BOCCOLA GOMMA	BAGUE
14	REC6E5-44312-00	6E5-44312-00	TAPA CUERPO BOMBA AGUA	COVER, WATER PUMP HOUSING	COPERCHIO CORPO POMPA	COUVERCLE

GUÍA PIEZAS COLA

STERN DRIVE  
COMPONENTS GUIDE

GUIDA RICAMBI  
PIEDI

GUIDE PIÈCES  
D'EMBASE

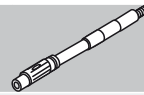

2B	1981-03	REC646-45551-00	REC646-45560-00					
4A	1985-87	REC6E0-45551-00	REC6E0-45560-00	REC6E0-45570-00	REC6E0-45631-00		PAF4-03050001	REC6E0-45511-01
4AC	1987-99	REC6E0-45551-00	REC6E0-45560-00	REC6E0-45570-00	REC6E0-45631-00		PAF4-03050001	REC6E0-45511-01
4AC MHL 4AC MHS	2001-03	REC6E0-45551-00	REC6E0-45560-00	REC6E0-45570-00	REC6E0-45631-00		PAF4-03050001	REC6E0-45511-11
4AS	1987-96	REC6E0-45551-00	REC6E0-45560-00	REC6E0-45570-00	REC6E0-45631-00		PAF4-03050001	REC6E0-45511-01
4BC	1998-99	REC6E0-45551-00	REC6E0-45560-00	REC6E0-45570-00	REC6E0-45631-00		PAF4-03050001	REC6E0-45511-01
4BC	1999	REC6E0-45551-00	REC6E0-45560-00	REC6E0-45570-00	REC6E0-45631-00		PAF4-03050001	REC6E0-45511-01
4BC MHL 4BC MHS	2001-03	REC6E0-45551-00	REC6E0-45560-00	REC6E0-45570-00	REC6E0-45631-00		PAF4-03050001	REC6E0-45511-11
F4A	1998-00	REC6E0-45551-00	PAF4-03010000	PAF4-03040000			PAF4-03050001	REC6E0-45511-11
F4A MH F4A MHL	2000	REC6E0-45551-00	PAF4-03010000	PAF4-03040000			PAF4-03050001	REC6E0-45511-11
F4A MHS	2001	REC6E0-45551-00	PAF4-03010000	PAF4-03040000			PAF4-03050001	REC6E0-45511-11
5C	1985-99	REC6E0-45551-00	REC6E0-45560-00	REC6E0-45570-00	REC6E0-45631-00		PAF4-03050001	REC6E0-45511-01
5C MHL 5C MHS	2001-06	REC6E0-45551-00	REC646-45560-00	REC6E0-45570-00	REC6E0-45631-00		PAF4-03050001	REC6E0-45511-11
5CS	1987-96	REC6E0-45551-00	REC646-45560-00	REC6E0-45570-00	REC6E0-45631-00			REC6E0-45511-01
6C	1990-98	REC6NO-G5551-00	REC6NO-G5560-00	REC6NO-G5571-00	REC6G1-45631-00		REC6G1-45611-01	
6C MHL 6C MHS	2001-06	REC6NO-G5551-00	REC6NO-G5560-00	REC6NO-G5571-00	REC6G1-45631-00		REC6G1-45611-01	
6C WHL 6C WHS	2001	REC6NO-G5551-00	REC6NO-G5560-00	REC6NO-G5571-00	REC6G1-45631-00		REC6G1-45611-01	
6D	1990-98	REC6NO-G5551-00	REC6NO-G5560-00	REC6NO-G5571-00	REC6G1-45631-00		REC6G1-45611-01	
6D MHL 6D MHS	2001-06	REC6NO-G5551-00	REC6NO-G5560-00	REC6NO-G5571-00	REC6G1-45631-00		REC6G1-45611-01	
6D WHS	2001	REC6NO-G5551-00	REC6NO-G5560-00	REC6NO-G5571-00	REC6G1-45631-00		REC6G1-45611-01	
8C	1990-98	REC6NO-G5551-00	REC6NO-G5560-00	REC6NO-G5571-00	REC6G1-45631-00		REC6G1-45611-01	
8C MHL 8C MHS	2001-06	REC6NO-G5551-00	REC6NO-G5560-00	REC6NO-G5571-00	REC6G1-45631-00		REC6G1-45611-01	
8C MHX	2001-03	REC6NO-G5551-00	REC6NO-G5560-00	REC6NO-G5571-00	REC6G1-45631-00		REC6G1-45611-01	
8C WHL 8C WHS	2001-03	REC6NO-G5551-00	REC6NO-G5560-00	REC6NO-G5571-00	REC6G1-45631-00		REC6G1-45611-01	
E8D	1997-98	REC647-45551-00	REC647-45560-00	REC647-45570-00				
E8D MH	1999	REC647-45551-00	REC647-45560-00	REC647-45570-00				
F8A	1986-89				REC682-45631-00	REC648-45633-00		
F8B	1985-99	REC6E7-45551-00	REC6E7-45560-01	REC6E7-45570-00	REC682-45631-00	REC648-45633-00	REC683-45611-00	
F8B E F8B EH F8B MH	1999	REC6E7-45551-00	REC6E7-45560-01	REC6E7-45570-00	REC682-45631-00	REC648-45633-00	REC683-45611-00	
FT8D EL	2001-04					REC648-45633-00	REC683-45611-00	REC69G-45510-20
FT8D EPL	2001-04					REC648-45633-00	REC683-45611-00	REC69G-45510-10
FT8D EPX	2001-02					REC648-45633-00	REC683-45611-00	REC69G-45510-10
FT8D EX	2001-04					REC648-45633-00	REC683-45611-00	REC69G-45510-20
FT8D MHL FT8D MHX	2001-04					REC648-45633-00	REC683-45611-00	REC69G-45510-10
9.9D	1985-89	REC6E7-45551-00	REC6E7-45560-01	REC6E7-45570-00	REC682-45631-00	REC648-45633-00	REC683-45611-00	REC69G-45510-20
9.9D	1990-95	REC6E7-45551-00	REC6E7-45560-01	REC6E7-45570-00	REC682-45631-00	REC648-45633-00	REC683-45611-00	REC683-45361-02-4D
9.9F	1995-99	REC63V-45551-00	REC6E7-45560-01	REC6E7-45570-00	REC682-45631-00	REC648-45633-00	REC683-45611-00	REC683-45361-02-4D
9.9F MH	2000	REC63V-45551-00	REC6E7-45560-01	REC6E7-45570-00	REC682-45631-00	REC648-45633-00	REC683-45611-00	REC683-45361-02-4D
9.9F MHL 9.9F MHS 9.9F WC 9.9F WH	2001-06	REC63V-45551-00	REC6E7-45560-01	REC6E7-45570-00	REC682-45631-00	REC648-45633-00	REC683-45611-00	REC683-45361-02-4D
9.9F WHL 9.9F WHS	2001	REC63V-45551-00	REC6E7-45560-01	REC6E7-45570-00	REC682-45631-00	REC648-45633-00	REC683-45611-00	REC683-45361-02-4D
F9.9B	1985-97	REC6E7-45551-00	REC6E7-45560-01	REC6E7-45570-00	REC682-45631-00	REC648-45633-00	REC683-45611-00	REC683-45361-02-4D
F9.9B E	1999	REC6E7-45551-00	REC6E7-45560-01	REC6E7-45570-00	REC682-45631-00	REC648-45633-00	REC683-45611-00	REC683-45361-02-4D
F9.9B EH	1999	REC6E7-45551-00	REC6E7-45560-01	REC6E7-45570-00	REC682-45631-00	REC648-45633-00	REC683-45611-00	REC683-45361-02-4D
F9.9B MH	1999	REC6E7-45551-00	REC6E7-45560-01	REC6E7-45570-00	REC682-45631-00	REC648-45633-00	REC683-45611-00	REC683-45361-02-4D
F9.9C	1998	REC63V-45551-00	REC6E7-45560-01	REC6E7-45570-00	REC682-45631-00	REC648-45633-00	REC683-45611-00	REC683-45361-02-4D
F9.9C E	2000	REC63V-45551-00	REC6E7-45560-01	REC6E7-45570-00	REC682-45631-00	REC648-45633-00	REC683-45611-00	REC683-45361-02-4D
F9.9C EH	2000	REC63V-45551-00	REC6E7-45560-01	REC6E7-45570-00	REC682-45631-00	REC648-45633-00	REC683-45611-00	REC683-45361-02-4D
F9.9C EL F9.9C ES	2001-06	REC63V-45551-00	REC6E7-45560-01	REC6E7-45570-00	REC682-45631-00	REC648-45633-00	REC683-45611-00	REC683-45361-02-4D
F9.9C MH	2000	REC63V-45551-00	REC6E7-45560-01	REC6E7-45570-00	REC682-45631-00	REC648-45633-00	REC683-45611-00	REC683-45361-02-4D
F9.9C MHL F9.9C MHS	2001-06	REC63V-45551-00	REC6E7-45560-01	REC6E7-45570-00	REC682-45631-00	REC648-45633-00	REC683-45611-00	REC683-45361-02-4D
FT9.9A	1999				REC682-45631-00	REC648-45633-00		
FT9.9D	1999				REC682-45631-00	REC648-45633-00	REC683-45611-00	
FT9.9D E FT9.9D EH FT9.9D EHL FT9.9D EHX	2000				REC682-45631-00	REC648-45633-00	REC683-45611-00	



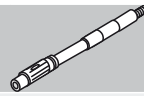

25D MH	1998	REC689-45551-00	REC689-45560-00	REC689-45571-00-00	REC664-45631-00	REC648-45633-00		PAF25-04070000	REC689-45501-10
25D MHL									
25D MHS	2001	REC689-45551-00	REC689-45560-00	REC689-45571-00-00	REC664-45631-00	REC648-45633-00		PAF25-04070000	
25J	1987-91					REC648-45633-00		PAF25-04070000	
25J	1992-00					REC648-45633-00		PAF25-04070000	
25N	1988					REC648-45633-00	REC6L2-45611-00	PAF25-04070000	
25N MHOL									
25N MHOS	2001-06					REC648-45633-00	REC6L2-45611-00	PAF25-04070000	
25N WOL									
25N WOS	2001-03					REC648-45633-00	REC6L2-45611-00	PAF25-04070000	
25Q	1988-94	REC6H4-45551-00	REC6H4-45560-00	REC6H4-45570-00	REC663-45631-00	REC648-45633-00	REC679-45611-00	PAF25-04070000	
25V	1996	REC61N-45551-00	REC61N-45560-10	REC61N-45570-00	REC664-45631-00	REC648-45633-00	REC6L2-45611-00	PAF25-04070000	REC61N-45510-10
25V	1996-98	REC61N-45551-00	REC61N-45560-10	REC61N-45570-00	REC664-45631-00	REC648-45633-00	REC6L2-45611-00	PAF25-04070000	REC61N-45510-10
25V MHL									
25V MHS	2001	REC61N-45551-00	REC61N-45560-10	REC61N-45570-00	REC664-45631-00	REC648-45633-00	REC6L2-45611-00	PAF25-04070000	REC61N-45510-10
25V WCS	2001	REC61N-45551-00	REC61N-45560-10	REC61N-45570-00	REC664-45631-00	REC648-45633-00	REC6L2-45611-00	PAF25-04070000	REC61N-45510-10
F25A E									
F25A EH	2000	REC61N-45551-00	REC61N-45560-10	REC61N-45570-00	REC664-45631-00	REC648-45633-00	REC6L2-45611-00	PAF25-04070000	REC61N-45510-10
F25A EHL	2001-02	REC61N-45551-00	REC61N-45560-10	REC61N-45570-00	REC664-45631-00	REC648-45633-00	REC6L2-45611-00	PAF25-04070000	REC61N-45510-10
F25A EHS	2001	REC61N-45551-00	REC61N-45560-10	REC61N-45570-00	REC664-45631-00	REC648-45633-00	REC6L2-45611-00	PAF25-04070000	REC61N-45510-10
F25A EL									
F25A ES	2001-06	REC61N-45551-00	REC61N-45560-10	REC61N-45570-00	REC664-45631-00	REC648-45633-00	REC6L2-45611-00	PAF25-04070000	REC61N-45510-10
F25A ET	2000	REC61N-45551-00	REC61N-45560-10	REC61N-45570-00	REC664-45631-00	REC648-45633-00	REC6L2-45611-00	PAF25-04070000	REC61N-45510-10
F25A ETL	2001-06	REC61N-45551-00	REC61N-45560-10	REC61N-45570-00	REC664-45631-00	REC648-45633-00	REC6L2-45611-00	PAF25-04070000	REC61N-45510-10
F25A MH	2000	REC61N-45551-00	REC61N-45560-10	REC61N-45570-00	REC664-45631-00	REC648-45633-00	REC6L2-45611-00	PAF25-04070000	REC61N-45510-10
F25A MHL									
F25A MHS	2001-06	REC61N-45551-00	REC61N-45560-10	REC61N-45570-00	REC664-45631-00	REC648-45633-00	REC6L2-45611-00	PAF25-04070000	REC61N-45510-10
FT25B ED	2000						REC66T-45611-00	REC63D-45361-02-4D	
FT25B EDL									
FT25B EDX	2001-02						REC66T-45611-00	REC63D-45361-02-4D	
FT25B ET	2000						REC66T-45611-00	REC63D-45361-02-4D	
FT25B ETL	2001-06						REC66T-45611-00	REC63D-45361-02-4D	
FT25B ETX	2001-02						REC66T-45611-00	REC63D-45361-02-4D	
30A	1985	REC689-45551-00	REC689-45560-00	REC689-45571-00-00	REC664-45631-00	REC648-45633-00	REC689-45611-00		
30A M	1990-92	REC689-45551-00	REC689-45560-00	REC689-45571-00-00	REC664-45631-00	REC648-45633-00	REC689-45611-00		REC689-45501-10
30D	1986-00					REC648-45633-00			
30D EOL									
30D EOS									
30D ETOL	2001-06					REC648-45633-00			
30D MHOL									
30D MHOS									
30D OL	2001-03					REC648-45633-00			
30D EOS	2001-06					REC648-45633-00			
30G	1996	REC61N-45551-00	REC61N-45560-10	REC61N-45570-00	REC664-45631-00	REC648-45633-00	REC6L2-45611-00	PAF25-04070000	REC61N-45510-10
30G	1996-98	REC61N-45551-00	REC61N-45560-10	REC61N-45570-00	REC664-45631-00	REC648-45633-00	REC6L2-45611-00	PAF25-04070000	REC61N-45510-10
30G MHS									
30G WCS	2001	REC61N-45551-00	REC61N-45560-10	REC61N-45570-00		REC648-45633-00	REC6L2-45611-00	PAF25-04070000	REC61N-45510-10
30H MHS	2001-02	REC61N-45551-00	REC61N-45560-10	REC61N-45570-00	REC664-45631-00	REC648-45633-00	REC6L2-45611-00	PAF25-04070000	REC61N-45510-10
30H WCS	2001-02	REC61N-45551-00	REC61N-45560-10	REC61N-45570-00	REC664-45631-00	REC648-45633-00	REC6L2-45611-00	PAF25-04070000	REC61N-45510-10
F30A ETL	2001-06	REC66T-45551-00	REC66T-45560-00	REC66T-45571-00	REC66T-45631-00		REC66T-45611-00	REC63D-45361-02-4D	REC67C-45501-10
F30A ETS	2001-06	REC66T-45551-00	REC66T-45560-00	REC66T-45571-00	REC66T-45631-00		REC66T-45611-00	REC63D-45361-02-4D	REC67C-45501-10
F30A MHDL	2001-06	REC66T-45551-00	REC66T-45560-00	REC66T-45571-00	REC66T-45631-00		REC66T-45611-00	REC63D-45361-02-4D	REC67C-45501-10
F30A MHDS	2001-06	REC66T-45551-00	REC66T-45560-00	REC66T-45571-00	REC66T-45631-00		REC66T-45611-00	REC63D-45361-02-4D	REC67C-45501-10
E40G WH	2003	REC6F5-45551-00	REC6F5-45560-00	REC6F5-45570-00	REC663-45631-00	REC663-45633-00	REC6F6-45611-00	REC63D-45361-02-4D	REC676-45501-10
40H	1985-90	REC6H4-45551-00	REC6H4-45560-00	REC6H4-45570-00	REC6H4-45631-00	REC663-45633-00	REC679-45611-00		
40H	1991-93	REC6H4-45551-00	REC6H4-45560-00	REC6H4-45570-00	REC6H4-45631-00	REC663-45633-00	REC679-45611-00		
40Q	1993-98	REC6H9-45551-00	REC679-45560-00	REC677-41112-A0	REC663-45631-00	REC663-45633-00	REC679-45611-00		REC679-45501-10
40Q E	1992	REC6H9-45551-00	REC679-45560-00	REC677-41112-A0	REC663-45631-00	REC663-45633-00	REC679-45611-00		REC679-45501-10
40Q M	1990-92	REC6H9-45551-00	REC679-45560-00	REC677-41112-A0	REC663-45631-00	REC663-45633-00	REC679-45611-00		REC679-45501-10
40R MHO	2000	REC6H4-45551-00	REC6H4-45560-00	REC6H4-45570-00		REC663-45633-00		REC63D-45361-02-4D	
40R ROS	2001	REC6H4-45551-00	REC6H4-45560-00	REC6H4-45570-00		REC663-45633-00		REC63D-45361-02-4D	
40V	1995-98	REC6H4-45551-00	REC6H4-45560-00	REC6H4-45570-00		REC663-45633-00		REC63D-45361-02-4D	
40V EO	2000	REC6H4-45551-00	REC6H4-45560-00	REC6H4-45570-00		REC663-45633-00		REC63D-45361-02-4D	
40V EOL									
40V EOS	2001-06	REC6H4-45551-00	REC6H4-45560-00	REC6H4-45570-00		REC663-45633-00		REC63D-45361-02-4D	
40V ETO	2000	REC6H4-45551-00	REC6H4-45560-00	REC6H4-45570-00		REC663-45633-00		REC63D-45361-02-4D	
40V ETOL									
40V ETOS	2001-03	REC6H4-45551-00	REC6H4-45560-00	REC6H4-45570-00		REC663-45633-00		REC63D-45361-02-4D	
40V MHOL									
40V MHOS	2001-06	REC6H4-45551-00	REC6H4-45560-00	REC6H4-45570-00		REC663-45633-00		REC63D-45361-02-4D	
40V MO	2000	REC6H4-45551-00	REC6H4-45560-00	REC6H4-45570-00		REC663-45633-00		REC63D-45361-02-4D	
40X	1998	REC66T-45551-00	REC66T-45560-00	REC66T-45571-00	REC66T-45631-00	REC663-45633-00	REC66T-45611-00	REC63D-45361-02-4D	REC66T-45501-10
40X MH	2000	REC66T-45551-00	REC66T-45560-00	REC66T-45571-00	REC66T-45631-00	REC663-45633-00	REC66T-45611-00	REC63D-45361-02-4D	REC66T-45501-10
40X MHL	2001-06	REC66T-45551-00	REC66T-45560-00	REC66T-45571-00	REC66T-45631-00	REC663-45633-00	REC66T-45611-00	REC63D-45361-02-4D	REC66T-45501-10
40X MHS	2001-02	REC66T-45551-00	REC66T-45560-00	REC66T-45571-00	REC66T-45631-00	REC663-45633-00	REC66T-45611-00	REC63D-45361-02-4D	REC66T-45501-01
40X W	2000	REC66T-45551-00	REC66T-45560-00	REC66T-45571-00	REC66T-45631-00	REC663-45633-00	REC66T-45611-00	REC63D-45361-02-4D	REC66T-45501-10
40X WL									
40X WS	2001	REC66T-45551-00	REC66T-45560-00	REC66T-45571-00	REC66T-45631-00	REC663-45633-00	REC66T-45611-00	REC63D-45361-02-4D	REC66T-45501-10









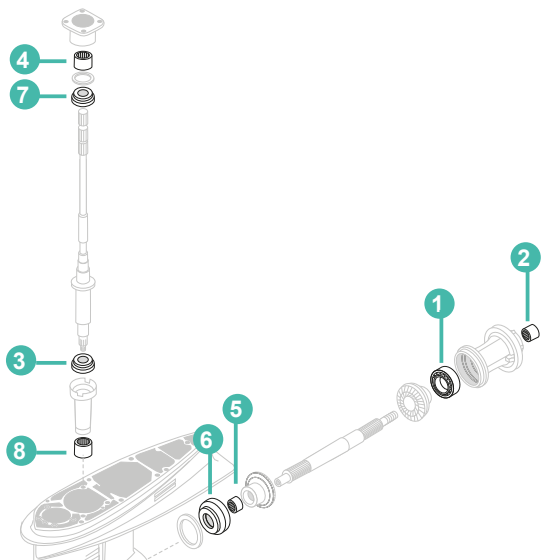

**GUÍA RODAMIENTOS STERN DRIVE BEARING GUIDA CUSCINETTI GUIDE ROULEMENTS APPLICATION TRASMISIONE D'EMBASE**

		1	2	3	4	5	6	7	8
F8A	1986-89				REC93315-317U2		REC93332-00005		REC93306-00501
F8B	1985-99	REC93315-314V8		REC93341-214U1	REC93315-317U2		REC93332-00005		REC93306-00501
F8B E F8B EH F8B MH	1999	REC93315-314V8		REC93341-41414	REC93315-317U2		REC93332-00005		REC93306-00501
FT8D EL FT8D EPL	2001-04	REC93315-314V8		REC93341-41414	REC93315-317U2		REC93332-00005		REC93306-00501
FT8D EPX	2001-02	REC93315-314V8		REC93341-41414	REC93315-317U2		REC93332-00005		REC93306-00501
FT8D EX FT8D MHL FT8D MHX	2001-04	REC93315-314V8		REC93341-41414	REC93315-317U2		REC93332-00005		REC93306-00501
9.9D	1985-89	REC93315-314V8		REC93341-41414	REC93315-317U2		REC93332-00005		REC93306-00501
9.9D	1985-95	REC93315-314V8		REC93341-214U1	REC93315-317U2		REC93332-00005		REC93306-00501
9.9D	1990-95	REC93315-314V8		REC93341-41414	REC93315-317U2		REC93332-00005		REC93306-00519
9.9F	1995-99	REC93315-314V8		REC93341-41414	REC93315-317U2		REC93332-00005		REC93306-00501
9.9F MH	2000	REC93315-314V8		REC93341-41414	REC93315-317U2		REC93332-00005		REC93306-00501
9.9F MHL 9.9F MHS	2001-06	REC93315-314V8		REC93341-41414	REC93315-317U2		REC93332-00005		REC93306-00501
9.9F WC 9.9F WH	2000	REC93315-314V8		REC93341-41414	REC93315-317U2		REC93332-00005		REC93306-00501
9.9F WHL 9.9F WHS	2001	REC93315-314V8		REC93341-41414	REC93315-317U2		REC93332-00005		REC93306-00501
F9.9B	1985-97	REC93315-314V8		REC93341-214U1	REC93315-317U2		REC93332-00005		REC93306-00501
F9.9B E F9.9B EH F9.9B MH	1999	REC93315-314V8		REC93341-41414	REC93315-317U2		REC93332-00005		REC93306-00501
F9.9C	1998	REC93315-314V8		REC93341-41414	REC93315-317U2		REC93332-00005		REC93306-00501
F9.9C E F9.9C EH	2000	REC93315-314V8		REC93341-41414	REC93315-317U2		REC93332-00005		REC93306-00501
F9.9C EL F9.9C ES	2001-06	REC93315-314V8		REC93341-41414	REC93315-317U2		REC93332-00005		REC93306-00501
F9.9C MH	2000	REC93315-314V8		REC93341-41414	REC93315-317U2		REC93332-00005		REC93306-00501
F9.9C MHL F9.9C MHS	2001-06	REC93315-314V8		REC93341-41414	REC93315-317U2		REC93332-00005		REC93306-00501
FT9.9A	1999				REC93315-317U2		REC93332-00005		REC93306-00501
FT9.9D	1999	REC93315-314V8		REC93341-41414	REC93315-317U2		REC93332-00005		REC93306-00501
FT9.9D E FT9.9D EH	2000	REC93315-314V8		REC93341-41414	REC93315-317U2		REC93332-00005		REC93306-00501
FT9.9D EHL FT9.9D EHX	2001	REC93315-314V8		REC93341-41414	REC93315-317U2		REC93332-00005		REC93306-00501
FT9.9D EL	2001-06	REC93315-314V8		REC93341-41414	REC93315-317U2		REC93332-00005		REC93306-00501
FT9.9D EP	2000	REC93315-314V8		REC93341-41414	REC93315-317U2		REC93332-00005		REC93306-00501
FT9.9D EPL FT9.9D EPX	2001-02	REC93315-314V8		REC93341-41414	REC93315-317U2		REC93332-00005		REC93306-00501
FT9.9D ES	2001	REC93315-314V8		REC93341-41414	REC93315-317U2		REC93332-00005		REC93306-00501
FT9.9D EX	2001-06	REC93315-314V8		REC93341-41414	REC93315-317U2		REC93332-00005		REC93306-00501
FT9.9D MH	2000	REC93315-314V8		REC93341-41414	REC93315-317U2		REC93332-00005		REC93306-00501
FT9.9D MHL	2001-06	REC93315-314V8		REC93341-41414	REC93315-317U2		REC93332-00005		REC93306-00501
FT9.9D MHX	2001	REC93315-314V8		REC93341-41414	REC93315-317U2		REC93332-00005		REC93306-00501
13.5A	1999	REC93315-314V8		REC93341-41414	REC93315-317U2		REC93332-00005		REC93306-00501
13.5A MH	2000	REC93315-314V8		REC93341-41414	REC93315-317U2		REC93332-00005		REC93306-00501
13.5A MHL 13.5A MHS	2001-04	REC93315-314V8		REC93341-41414	REC93315-317U2		REC93332-00005		REC93306-00501
13.5A WH	2000	REC93315-314V8		REC93341-41414	REC93315-317U2		REC93332-00005		REC93306-00501
F13.5A EHL	2005-06	REC93315-314V8			REC93315-317U2		REC93332-00005		REC93306-00501
F13.5A EPL	2005	REC93315-314V8		REC93341-41414	REC93315-317U2		REC93332-00005		REC93306-00501
F13.5A EPS	2005	REC93315-314V8			REC93315-317U2		REC93332-00005		REC93306-00501
F13.5A MH	2001	REC93315-314V8			REC93315-317U2				REC93306-00501
F13.5A MHL F13.5A MHS	2002-06	REC93315-314V8		REC93341-41414	REC93315-317U2		REC93332-00005		REC93306-00501



		1	2	3	4	5	6	7	8
15D	1985-95	REC93315-314V8		REC93341-214U1	REC93315-317U2		REC93332-00005		REC93306-00501
15D	1990-95	REC93315-314V8		REC93341-41414	REC93315-317U2		REC93332-00005		REC93306-00501
15F	1995-99	REC93315-314V8		REC93341-41414	REC93315-317U2		REC93332-00005		REC93306-00501
15F MH	2000	REC93315-314V8		REC93341-41414	REC93315-317U2		REC93332-00005		REC93306-00501
15F MHL 15F MHS	2001-06	REC93315-314V8		REC93341-41414	REC93315-317U2		REC93332-00005		REC93306-00501
15F WC	2000	REC93315-314V8		REC93341-41414	REC93315-317U2		REC93332-00005		REC93306-00501
15F WCL	2001-03	REC93315-314V8		REC93341-41414	REC93315-317U2		REC93332-00005		REC93306-00501
15F WCS	2001-02	REC93315-314V8		REC93341-41414	REC93315-317U2		REC93332-00005		REC93306-00501
F15A	1998	REC93315-314V8		REC93341-41414	REC93315-317U2		REC93332-00005		REC93306-00501
F15A E F15A EH F15A EHS F15A EHL F15A EL	1998-00	REC93315-314V8		REC93341-41414	REC93315-317U2		REC93332-00005		REC93306-00501
F15A EP	2001-06	REC93315-314V8		REC93341-41414	REC93315-317U2		REC93332-00005		REC93306-00501
F15A EPL	2001-06	REC93315-314V8		REC93341-41414	REC93315-317U2		REC93332-00005		REC93306-00501
F15A EPS	2001-06	REC93315-314V8		REC93341-41414	REC93315-317U2		REC93332-00005		REC93306-00501
F15A ES	2001-06	REC93315-314V8		REC93341-41414	REC93315-317U2		REC93332-00005		REC93306-00501
F15A MH	1998-00	REC93315-314V8		REC93341-41414	REC93315-317U2		REC93332-00005		REC93306-00501
F15A MHL	2001-06	REC93315-314V8		REC93341-41414	REC93315-317U2		REC93332-00005		REC93306-00501
F15A MHS	2001-06	REC93315-314V8		REC93341-41414	REC93315-317U2		REC93332-00005		REC93306-00501
20C	1985-93	REC93315-017U4			REC93315-22004		REC93332-00005		REC93306-00612
20C M	1990-97	REC93315-017U4			REC93315-22004		REC93332-00005		REC93306-00612
20C MH	1998	REC93315-017U4			REC93315-22004		REC93332-00005		REC93306-00612
20C MHL 20C MHS	2001-02	REC93315-017U4			REC93315-22004		REC93332-00005		REC93306-00612
20D	1988		REC93315-22004		REC93315-22004		REC93332-00005		REC93306-00612
20D MHOL 20D MHOS	2001-06		REC93315-22004		REC93315-22004		REC93332-00005		REC93306-00612
20D WOL 20D WOS	2001		REC93315-22004		REC93315-22004		REC93332-00005		REC93306-00612
F20A	1998-99	REC93315-220V7	REC93332-000W5		REC93315-22004		REC93332-00005		REC93306-00612
F20A E	2000		REC93332-000W5		REC93315-22004		REC93332-00005		REC93306-00612
F20A EH	2000	REC93315-220V7	REC93332-000W5		REC93315-22004		REC93332-00005		REC93306-00612
F20A EHS	2001	REC93315-220V7			REC93315-22004		REC93332-00005		REC93306-00612
F20A EL	2001	REC93315-220V7	REC93332-000W5		REC93315-22004		REC93332-00005		REC93306-00612
F20A ES	2001-06	REC93315-220V7	REC93332-000W5		REC93315-22004		REC93332-00005		REC93306-00612
F20A ET	2000	REC93315-220V7	REC93332-000W5		REC93315-22004		REC93332-00005		REC93306-00612
F20A ETL	2003-06	REC93315-220V7	REC93332-000W5		REC93315-22004		REC93332-00005		REC93306-00612
F20A MH F20A MHL	2000	REC93315-220V7	REC93332-000W5		REC93315-22004		REC93332-00005		REC93306-00612
F20A MHS	2001	REC93315-220V7	REC93332-000W5		REC93315-22004		REC93332-00005		REC93306-00612
25B	1994-95	REC93315-325V1	REC93332-00001		REC93317-22204		REC93332-000W7		REC93306-00702
25B MHL 25B MHS	2001-06	REC93315-220V7	REC93332-000W5		REC93315-22004		REC93332-00005		REC93306-00612
25B WCS	2001-02	REC93315-220V7	REC93332-000W5		REC93315-22004		REC93332-00005		REC93306-00612
25D	1985-87	REC93315-017U4			REC93315-22004		REC93332-00005		REC93306-00612
25D M	1990-97	REC93315-017U4			REC93315-22004		REC93332-00005		REC93306-00612
25D MH	1998	REC93315-017U4			REC93315-22004		REC93332-00005		REC93306-00612
25D MHL 25D MHS	2001	REC93315-017U4			REC93315-22004		REC93332-00005		REC93306-00612
25J	1987-91	REC93315-220V7	REC93332-00023		REC93315-22004				REC93306-00612
25J	1992-00		REC93332-00001						REC93306-00612
25N	1988		REC93315-22004		REC93315-22004		REC93332-00005		REC93306-00612
25N MHOL 25N MHOS	2001-06		REC93315-22004		REC93315-22004		REC93332-00005		REC93306-00612
25N WOL	2001-03		REC93315-22004		REC93315-22004		REC93332-00005		REC93306-00612
25N WOS	2001-03				REC93315-22004		REC93332-00005		REC93306-00612
25Q	1988-91	REC93315-32224	REC93332-00023						REC93306-00612
25Q	1990-94	REC93315-32224	REC93332-00001		REC93317-22204				REC93306-00702
25V	1996-98	REC93315-220V7	REC93332-000W5		REC93315-22004		REC93332-00005		REC93306-00612
25V MHL 25V MHS 25V WVS	2001	REC93315-220V7	REC93332-000W5		REC93315-22004		REC93332-00005		REC93306-00612
F25A E F25A EH	2000	REC93315-220V7	REC93332-000W5		REC93315-22004		REC93332-00005		REC93306-00612
F25A EHL	2001-02	REC93315-220V7	REC93332-000W5		REC93315-22004		REC93332-00005		REC93306-00612
F25A EHS	2001	REC93315-220V7	REC93332-000W5		REC93315-22004		REC93332-00005		REC93306-00612
F25A EL F25A ES	2001-06	REC93315-220V7	REC93332-000W5		REC93315-22004		REC93332-00005		REC93306-00612
F25A ET	2000	REC93315-220V7	REC93332-000W5		REC93315-22004		REC93332-00005		REC93306-00612
F25A ETL	2001-06	REC93315-220V7	REC93332-000W5		REC93317-22204		REC93332-00005		REC93306-00612
F25A MH	2000	REC93315-220V7	REC93332-000W5		REC93315-22004		REC93332-00005		REC93306-00612
F25A MHL F25A MHS	2001-06	REC93315-220V7	REC93332-000W5		REC93315-22004		REC93332-00005		REC93306-00612
FT25B ED	2000	REC93315-32224	REC93332-00001		REC93317-22204		REC93332-00003		REC93306-001U1
FT25B EDL FT25B EDX	2001-02	REC93315-32224	REC93332-00001		REC93317-22204		REC93332-00003		REC93306-001U1

		1	2	3	4	5	6	7	8
FT25B ET	2000	REC93315-32224	REC93332-00001		REC93317-22204		REC93332-00003		REC93306-001U1
FT25B ETL	2001-06	REC93315-32224	REC93332-00001		REC93317-22204		REC93332-00003		REC93306-001U1
FT25B ETX	2001-02	REC93315-32224	REC93332-00001		REC93317-22204		REC93332-00003		REC93306-001U1
30A	1985	REC93315-017U4			REC93315-22004		REC93332-00005		REC93306-00612
30A M	1990-92	REC93315-017U4		REC93315-22004	REC93315-22004		REC93332-00005		REC93306-00612
30D	1986-00	REC93315-220V7	REC93332-00023		REC93315-22004				REC93306-00612
30D EOL									
30D EOL	2001-06	REC93315-220V7	REC93332-00001		REC93315-22004				REC93306-00612
30D ETOL									
30D MHOL									
30D MHOS	2001-06	REC93315-220V7	REC93332-00001		REC93315-22004				REC93306-00612
30D OL	2001-03		REC93332-00001		REC93315-22004				REC93306-00612
30D EOS	2001-06		REC93332-00001		REC93315-22004				REC93306-00612
30G	1996-98	REC93315-220V7	REC93332-000W5		REC93315-22004		REC93332-00005		REC93306-00612
30G MHS									
30G WCS	2001	REC93315-220V7	REC93332-000W5		REC93315-22004		REC93332-00005		REC93306-00612
30H MHS									
30H WCS	2001-02	REC93315-220V7	REC93332-000W5		REC93315-22004		REC93332-00005		REC93306-00612
F30A ETL									
F30A ETS	2001-06	REC93315-32224	REC93332-00001		REC93317-22204		REC93332-00003		REC93306-001U1
F30A MHDL									
F30A MHDS	2001-06	REC93315-32224	REC93332-00001		REC93317-22204		REC93332-00003		REC93306-001U1
40G WH	2003	REC93315-324U1	REC93315-217U0	REC93390-000U0			REC93332-000U0		
40H	1985-90	REC93315-32224	REC93332-00023		REC93317-22204				REC93306-00702
40H	1991-93	REC93315-32224	REC93332-00001		REC93317-22204				REC93306-00702
40Q	1993	REC93315-32224	REC93332-00001		REC93317-22204		REC93332-00003		REC93306-00702
40Q E	1992	REC93315-32224	REC93332-00023		REC93317-22204		REC93332-00003		REC93306-00702
40Q M	1990	REC93315-32224	REC93332-00023		REC93317-22204		REC93332-00003		REC93306-00702
40R MHO	2000	REC93315-32224	REC93332-00001		REC93317-22204		REC93332-00003		REC93306-001U1
40R ROS	2001	REC93315-32224	REC93332-00001		REC93317-22204		REC93332-00003		REC93306-001U1
40V	1995-98	REC93315-32224	REC93332-00001		REC93317-22204		REC93332-00003		REC93306-001U1
40V EO	2000	REC93315-32224	REC93332-00001		REC93317-22204		REC93332-00003		REC93306-001U1
40V EOL									
40V EOS	2001-06	REC93315-32224	REC93332-00001		REC93317-22204		REC93332-00003		REC93306-001U1
40V ETO	2000	REC93315-32224	REC93332-00001		REC93317-22204		REC93332-00003		REC93306-001U1
40V ETOL									
40V ETOS	2001-03	REC93315-32224	REC93332-00001		REC93317-22204		REC93332-00003		REC93306-001U1
40V MHOL									
40V MHOS	2001-06	REC93315-32224	REC93332-00001		REC93317-22204		REC93332-00003		REC93306-001U1
40V MO	2000	REC93315-32224	REC93332-00001		REC93317-22204		REC93332-00003		REC93306-001U1
40X	1998	REC93315-32224	REC93332-00001		REC93317-22204		REC93332-00003		REC93306-001U1
40X MH	2000	REC93315-32224	REC93332-00001		REC93317-22204		REC93332-00003		REC93306-001U1
40X MHL	2001-06	REC93315-32224	REC93332-00001		REC93317-22204		REC93332-00003		REC93306-001U1
40X MHS	2001-02	REC93315-32224	REC93332-00001		REC93317-22204		REC93332-00003		REC93306-001U1
40X W	2000	REC93315-32224	REC93332-00001		REC93317-22204		REC93332-00003		REC93306-001U1
40X WL									
40X WS	2001	REC93315-32224	REC93332-00001		REC93317-22204		REC93332-00003		REC93306-001U1
40X WT	2000		REC93332-00001		REC93317-22204		REC93332-00003		REC93306-001U1
40X WTL	2001-03	REC93315-32224	REC93332-00001		REC93317-22204		REC93332-00003		REC93306-001U1
40Y ETOL	2001-06	REC93315-32224	REC93332-00001		REC93317-22204		REC93332-00003		REC93306-001U1
40Y MHOS	2001-06	REC93315-32224	REC93332-00001		REC93317-22204		REC93332-00003		REC93306-001U1
E40G MH	2003	REC93315-324U1	REC93315-217U0	REC93390-000U0			REC93332-000U0		REC93332-000U0
E40G MHL	2003	REC93315-324U1	REC93315-217U0	REC93390-000U0			REC93332-000U0		REC93332-000U0
E40G MHS	2003	REC93315-324U1	REC93315-217U0	REC93390-000U0			REC93332-000U0		REC93332-000U0
F40A									
F40A ED	1999	REC93315-32224	REC93332-00001		REC93317-22204		REC93332-00003		REC93306-001U1
F40A EDL	2001	REC93315-32224	REC93332-00001		REC93317-22204		REC93332-00003		REC93306-001U1
F40A ET	1999	REC93315-32224	REC93332-00001		REC93317-22204		REC93332-00003		REC93306-001U1
F40A ETL	2001-02	REC93315-32224	REC93332-00001		REC93317-22204		REC93332-00003		REC93306-001U1
F40A ED	1999	REC93315-325V1	REC93332-00001		REC93317-22204		REC93332-00003		REC93306-207U0
F40B ED	2000-01	REC93315-32224	REC93332-00001		REC93317-22204		REC93332-00003		REC93306-001U1
F40B EDL	2001-06	REC93315-32224	REC93332-00001		REC93317-22204		REC93332-00003		REC93306-001U1
F40B EDS	2001-02	REC93315-32224	REC93332-00001		REC93317-22204		REC93332-00003		REC93306-001U1
F40B ET	2000-01	REC93315-32224	REC93332-00001		REC93317-22204		REC93332-00003		REC93306-001U1
F40B ETL									
F40B ETS	2001-06	REC93315-32224	REC93332-00001		REC93317-22204		REC93332-00003		REC93306-001U1
F40B MHD	2000	REC93315-32224	REC93332-00001		REC93317-22204		REC93332-00003		REC93306-001U1
F40B MHDL									
F40B MHDS	2001-06	REC93315-32224	REC93332-00001		REC93317-22204		REC93332-00003		REC93306-001U1
F40C ETL	2002-06	REC93315-32224	REC93332-00001		REC93317-22204				
F45A	1996-99	REC93315-32224	REC93332-00001		REC93317-22204		REC93332-000W7		REC93306-001U1
F45A ED									
F45A ET	2000	REC93315-32224	REC93332-00001		REC93317-22204		REC93332-000W7		REC93306-001U1
50D	1984-90	REC93315-32224	REC93332-00023		REC93317-22204				REC93306-00702
50D	1991-93	REC93315-32224	REC93332-00001						REC93306-00702
50G	1993-98	REC93315-325V1	REC93332-00001		REC93317-22204		REC93332-000W7		REC93306-00702
50G ETO	2000	REC93315-325V1	REC93332-00001		REC93317-22204		REC93332-00003		REC93306-00702
50G ETOL	2001-06	REC93315-325V1	REC93332-00001		REC93317-22204		REC93332-00003		REC93306-00702

		1	2	3	4	5	6	7	8
50H	1995-98	REC93315-32224	REC93332-00001		REC93317-22204		REC93332-00003		REC93306-001U1
50H EDO	2000	REC93315-32224	REC93332-00001		REC93317-22204		REC93332-00003		REC93306-001U1
50H EDOL	2001-02	REC93315-32224	REC93332-00001		REC93317-22204		REC93332-00003		REC93306-001U1
50H EDOS									
50H MDO	2000	REC93315-32224	REC93332-00001		REC93317-22204		REC93332-00003		REC93306-001U1
50H MO									
F50A	1995	REC93315-32224	REC93332-000U3		REC93317-22204		REC93332-00003		REC93306-001U1
F50A ED	2000	REC93315-32224	REC93332-00001	06	REC93317-22204		REC93332-00003		REC93306-001U1
F50A EDL	2001-06	REC93315-32224	REC93332-00001		REC93317-22204		REC93332-00003		REC93306-001U1
F50A ET	2000	REC93315-32224	REC93332-00001		REC93317-22204		REC93332-00003		REC93306-001U1
F50A ETL	2001-06	REC93315-32224	REC93332-00001		REC93317-22204		REC93332-00003		REC93306-001U1
F50B	1996-97	REC93315-32224	REC93332-00001		REC93317-22204		REC93332-00003		REC93306-001U1
F50B	1998-99	REC93315-325V1	REC93332-000U3		REC93317-22204		REC93332-000W7		REC93306-001U1
F50B ET	2000	REC93315-32224	REC93332-00001		REC93317-22204		REC93332-00003		REC93306-001U1
F50F EDL	2005-06	REC93315-32224	REC93332-00001		REC93317-22204				REC93306-001U1
F50F ETL									
FT50B	1998-99	REC93315-32224	REC93332-00001		REC93317-22204		REC93332-000W7		REC93306-001U1
FT50B ETL	2001-02	REC93315-32224	REC93332-00001		REC93317-22204		REC93332-00003		REC93306-001U1
FT50C ETL	2002-06	REC93315-32224	REC93332-00001		REC93317-22204		REC93332-00003		REC93306-001U1
FT50G ETL	2005-06		REC93332-000U3		REC93317-325U0				REC93306-001U1
55B	1993-98	REC93315-32224	REC93332-00001		REC93317-22204		REC93332-00003		REC93306-00702
55B E	1990-91	REC93315-32224	REC93332-00001		REC93317-22204		REC93332-00003		REC93306-00702
55B E	1992	REC93315-32224	REC93332-00023		REC93317-22204		REC93332-00003		REC93306-00702
55B EHD	2000	REC93315-32224	REC93332-00001		REC93317-22204		REC93332-00003		REC93306-00702
55B ET	2000	REC93315-32224	REC93332-00001		REC93317-22204		REC93332-00003		REC93306-00702
55B ETL	2001-02	REC93315-32224	REC93332-00001		REC93317-22204	-06	REC93332-00003		REC93306-00702
60F	1984-98	REC93315-325V1	REC93332-00001		REC93317-22204		REC93332-000W7		REC93306-00702
60F EO									
60F ETO	2000	REC93315-325V1	REC93332-00001		REC93317-22204		REC93332-00003		REC93306-00702
60F ETOL	2001-06	REC93315-325V1	REC93332-00001		REC93317-22204		REC93332-00003		REC93306-00702
E60H MHDL	2001-06	REC93315-325V1	REC93332-000U3		REC93317-325U0		REC93332-000W7		REC93306-207U0
F60A ETL	2002-06	REC93315-32224	REC93332-00001		REC93317-22204				REC93306-001U1
F60C ETL	2005-06	REC93315-32224	REC93332-00001		REC93317-22204				REC93306-001U1
FT60B ETL	2003-06		REC93332-000U3		REC93317-325U0				REC93306-207U0
FT60D ETL	2005-06		REC93332-000U3		REC93317-325U0				REC93306-207U0
70B	1984-98	REC93315-325V1	REC93332-00001		REC93317-22204		REC93332-000W7		REC93306-00702
70B EDOL	2001	REC93315-325V1	REC93332-00001		REC93317-22204		REC93332-00003		REC93306-00702
70B EO									
70B ETO	2000	REC93315-325V1	REC93332-00001		REC93317-22204		REC93332-00003		REC93306-00702
70B ETOL	2001-06	REC93315-325V1	REC93332-00001		REC93317-22204		REC93332-00003		REC93306-00702
75A	1990-98	REC93315-325V1	REC93332-000U3		REC93317-325U0		REC93332-000W7		REC93306-207U0
75A E	1990-00	REC93315-325V1	REC93332-000U3		REC93317-325U0		REC93332-000U5		REC93306-207U0
75A EDL	2001-06	REC93315-325V1	REC93332-000U3		REC93317-325U0		REC93332-000W7		REC93306-207U0
75A EM	1992-93		REC93332-000U3		REC93317-325U0		REC93332-000U5		REC93306-207U0
75A ET	2000	REC93315-325V1			REC93317-325U0		REC93332-000U5		REC93306-207U0
75A ETL	2001-02	REC93315-325V1	REC93332-000U3		REC93317-325U0		REC93332-000W7		REC93306-207U0
75A MHD	2000	REC93315-325V1	REC93332-000U3		REC93317-325U0				REC93306-207U0
75C	1998	REC93315-325V1			REC93317-325U0		REC93332-000W7		REC93306-207U0
75C ETO	2000	REC93315-325V1	REC93332-000U3		REC93317-325U0		REC93332-000W7		REC93306-207U0
75C ETOL	2001-06	REC93315-325V1	REC93332-000U3		REC93317-325U0		REC93332-000W7		REC93306-207U0
80A	1985-96	REC93315-325V1	REC93332-000U3		REC93317-325U0		REC93332-000U5		REC93306-207U0
F80A	1999		REC93332-000U3		REC93317-325U0	REC93317-322V0			REC93306-207U0
F80A ET	2000		REC93332-000U3		REC93317-325U0	REC93317-322V0			REC93306-207U0
F80A ETL	2001-06		REC93332-000U3		REC93317-325U0	REC93317-322V0			REC93306-207U0
F80A ETX	2001		REC93332-000U3		REC93317-325U0	REC93317-322V0			REC93306-207U0
F80B ETL	2005-06		REC93332-000U3		REC93317-325U0	REC93317-322V0			REC93306-207U0
85A	1996-98	REC93315-325V1	REC93332-000U3		REC93317-325U0		REC93332-000W7		REC93306-207U0
85A E	1990-00	REC93315-325V1	REC93332-000U3		REC93317-325U0		REC93332-000U5		REC93306-207U0
85A ET	2000	REC93315-325V1	REC93332-000U3		REC93317-325U0		REC93332-000U5		REC93306-207U0
85A ETL	2001-02	REC93315-325V1	REC93332-000U3		REC93317-325U0		REC93332-000W7		REC93306-207U0
90A	1984-98	REC93315-325V1	REC93332-000U3		REC93317-325U0		REC93332-000W7		REC93306-207U0
90A ETO	2000	REC93315-325V1	REC93332-000U3		REC93317-325U0		REC93332-000U7		REC93306-207U0
90A ETOL	2001-06	REC93315-325V1	REC93332-000U3		REC93317-325U0		REC93332-000W7		REC93306-207U0
100A	1998	REC93315-628U9	REC93315-430V5 REC93341-930V2		REC93315-430U8	REC93315-425U7	REC93332-000U7		REC93306-208U0
100A ETO	2000	REC93315-628U9	REC93317-330U2 REC93341-930V2		REC93315-430U8	REC93315-425U7			REC93306-208U0
100A ETOL	2001	REC93315-628U9	REC93317-330U2 REC93341-930V2		REC93315-430U8	REC93315-425U7	REC93332-000U7		REC93306-208U0
F100A	1999		REC93332-000U3		REC93317-325U0	REC93317-322V0			REC93306-207U0
F100A ET	2000		REC93332-000U3		REC93317-325U0	REC93317-322V0			REC93306-207U0
F100A ETL	2001-06		REC93332-000U3		REC93317-325U0	REC93317-322V0			REC93306-207U0
F100A ETX	2001		REC93332-000U3		REC93317-325U0	REC93317-322V0			REC93306-207U0

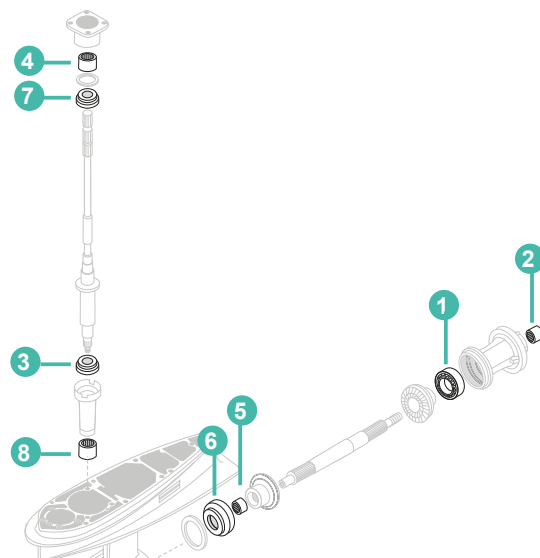

		1	2	3	4	5	6	7	8
F100B ETX	2005-06	REC93315-628U9	REC93317-330U2 REC93341-930V2		REC93315-430U8	REC93315-425U7	REC93332-000U7		REC93306-208U0
F100D ETL	2005-06		REC93332-000U3		REC93317-325U0	REC93317-322V0			REC93306-207U0
115A	1984-87	REC93315-628U9	REC93317-330U2 REC93341-930V2		REC93315-430U8	REC93315-425U7	REC93332-000U7		REC93306-208U0
115B	1988-95	REC93315-628U9	REC93317-330U2 REC93341-930V2		REC93315-430U8	REC93315-425U7	REC93332-000U7		REC93306-208U0
115B	1996	REC93315-628U9	REC93315-430V5 REC93341-930V2		REC93315-430U8	REC93315-425U7	REC93332-000U7		REC93306-208U0
115B ETO	1997-98	REC93315-628U9	REC93315-430V5 REC93341-930V2		REC93315-430U8	REC93315-425U7	REC93332-000U7		REC93306-208U0
115B ETO	1999-00	REC93315-628U9	REC93317-330U2			REC93315-425U7	REC93332-000U7		REC93306-208U0
115B ETOL	2001-02	REC93315-628U9	REC93317-330U2 REC93341-930V2		REC93315-430U8	REC93315-425U7	REC93332-000U7		REC93306-208U0
115C	1990-95	REC93315-628U9	REC93317-330U2 REC93341-930V2		REC93315-430U8	REC93315-425U7	REC93332-000U7	REC93315-430V5	REC93306-208U0
115C ETO	2000	REC93315-628U9	REC93317-330U2 REC93341-930V2		REC93315-430U8	REC93315-425U7	REC93332-000U7	REC93315-430V5	REC93306-208U0
115C ETOL	2001-06	REC93315-628U9	REC93317-330U2 REC93341-930V2		REC93315-43061	REC93315-425U7	REC93332-000U7	REC93315-430V5	REC93306-208U0
115C ETOX	2001-02	REC93315-628U9	REC93317-330U2 REC93341-930V2		REC93315-430U8	REC93315-425U7	REC93332-000U7	REC93315-430V5	REC93306-208U0
F115A ET	2000	REC93315-628U9	REC93317-330U2 REC93341-930V2		REC93315-430U8	REC93315-425U7	REC93332-000U7	REC93315-430V5	REC93306-208U0
F115A ETL F115A ETX	2001-06	REC93315-628U9	REC93317-330U2 REC93341-930V2		REC93315-430U8	REC93315-425U7	REC93332-000U7	REC93315-430V5	REC93306-208U0
FL115A ET	2000	REC93315-628U9	REC93317-330U2 REC93341-930V2		REC93315-430U8	REC93315-425U7	REC93332-000U7	REC93315-430V5	REC93306-208U0
FL115A ETX	2001-06	REC93315-628U9	REC93317-330U2 REC93341-930V2		REC93315-430U8	REC93315-425U7	REC93332-000U7	REC93315-430V5	REC93306-208U0
130B	1990-94	REC93315-628U9	REC93317-330U2 REC93341-930V2		REC93315-430U8	REC93315-425U7	REC93332-000U7	REC93315-430V5	REC93306-208U0
130B ETO	2000	REC93315-628U9	REC93317-330U2 REC93341-930V2		REC93315-430U8	REC93315-425U7	REC93332-000U7	REC93315-430V5	REC93306-208U0
130B ETOL	2001-06	REC93315-628U9	REC93317-330U2 REC93341-930V2		REC93315-43061	REC93315-425U7	REC93332-000U7	REC93315-430V5	REC93306-208U0
130B ETOX	2001	REC93315-628U9	REC93317-330U2 REC93341-930V2		REC93315-430U8	REC93315-425U7	REC93332-000U7	REC93315-430V5	REC93306-208U0
L130B	1991-94	REC93315-628U9	REC93317-330U2 REC93341-930V2		REC93315-430U8	REC93315-425U7	REC93332-000U7	REC93315-430V5	REC93306-208U0
L130B	1995-98	REC93315-628U9	REC93315-430V5 REC93341-930V2		REC93315-430U8	REC93315-425U7	REC93332-000U7		REC93306-208U0
L130B ETO	2000	REC93315-628U9	REC93317-330U2 REC93341-930V2		REC93315-430U8	REC93315-425U7	REC93332-000U7	REC93315-430V5	REC93306-208U0
L130B ETOX	2001	REC93315-628U9	REC93317-330U2 REC93341-930V2		REC93315-43061	REC93315-425U7	REC93332-000U7	REC93315-430V5	REC93306-208U0
140A	1984-87	REC93315-628U9	REC93317-330U2 REC93341-930V2		REC93315-430U8	REC93315-425U7	REC93332-000U7		REC93306-208U0
140B	1988-89	REC93315-628U9	REC93317-330U2 REC93341-930V2		REC93315-430U8	REC93315-425U7	REC93332-000U7		REC93306-208U0
L140B	1989	REC93315-628U9	REC93317-330U2 REC93341-930V2		REC93315-430U8	REC93315-425U7	REC93332-000U7	REC93315-430V5	REC93306-208U0
150A	1984-89	REC93311-928U5	REC93317-330U2 REC93341-930V2		REC93315-430U8	REC93315-425V3	REC93332-000V3 STD. ROT REC93390-000U2 C.ROT.	REC93315-430V5	REC93306-209U0 STD. ROT REC93332-00048 C.ROT.
150A ET	1998-00	REC93311-928U5	REC93317-330U2 REC93341-930V2		REC93315-430U8	REC93315-425V3	REC93332-000V3		REC93306-209U0
150A ETO	1986-87				REC93315-430U8		REC93390-000U2		REC93390-000U2
150A ETL	2001-02	REC93311-928U5	REC93317-330U2 REC93341-930V2		REC93315-430U8	REC93315-425V3	REC93332-000V3		REC93306-209U0
150A ETX	2001-02	REC93311-928U5	REC93317-330U2 REC93341-930V2		REC93315-430U8	REC93315-425V3	REC93332-000V3		REC93306-209U0
150C	1990-94	REC93311-928U5	REC93317-330U2 REC93341-930V2		REC93315-430U8	REC93315-425V3	REC93332-000V3		REC93306-209U0
150F	1996-98	REC93311-928U5	REC93315-430V5 REC93341-930V2		REC93315-430U8	REC93315-425V3	REC93390-000U2		REC93332-00048
150F	1997-98	REC93311-928U5	REC93315-430V5 REC93341-930V2		REC93315-430U8	REC93315-425V3	REC93332-000V3 STD. ROT REC93390-000U2 C.ROT.		REC93306-209U0 STD. ROT REC93332-00048 C.ROT.





		1	2	3	4	5	6	7	8
200B	1990-94	REC93311-928U5	REC93317-330U2 REC93341-930V2		REC93315-430U8	REC93315-425V3	REC93332-000V3		REC93306-209U0
200B	1995	REC93311-928U5	REC93315-430V5		REC93315-430U8	REC93315-425V3	REC93390-000U2 REC93332-000V3		REC93332-00048 REC93306-209U0
200F	1996-98	REC93311-928U5	REC93315-430V5 REC93341-930V2		REC93315-430U8	REC93315-425V3	STD. ROT REC93390-000U2 C.ROT.		STD. ROT REC93332-00048 C.ROT.
200F ETO	2000	REC93311-928U5	REC93317-330U2 REC93341-930V2		REC93315-430U8	REC93315-425V3	REC93332-000V3 STD. ROT REC93390-000U2 C.ROT.		REC93306-209U0 STD. ROT REC93332-00048 C.ROT.
200F ETOL 200F ETOX	2001-06	REC93311-928U5	REC93317-330U2 REC93341-930V2		REC93315-43061	REC93315-425V3	REC93332-000V3 STD. ROT REC93390-000U2 C.ROT.		REC93306-209U0 STD. ROT REC93332-00048 C.ROT.
200G	1999	REC93311-928U5	REC93317-330U2 REC93341-930V2		REC93315-430U8	REC93315-425V3	REC93332-000V3		REC93306-209U0
200G ETO	2000	REC93311-928U5	REC93317-330U2 REC93341-930V2		REC93315-430U8	REC93315-425V3	REC93332-000V3		REC93306-209U0
200G ETOL	2001-03	REC93311-928U5	REC93317-330U2 REC93341-930V2		REC93315-430U8	REC93315-425V3	REC93332-000V3		REC93306-209U0
F200A ETX	2002-06	REC93311-83280	REC93317-330U2		REC93315-43061		REC93332-000W1		REC93306-209U0 STD. ROT REC93332-00048 C.ROT.
F200C ETX	2006	REC93311-83280	REC93317-330U2				REC93332-000W1		REC93306-209U0 STD. ROT REC93332-00048 C.ROT.
FL200A ETX	2002-06	REC93311-83280	REC93317-330U2		REC93315-43061		REC93332-000W1		REC93306-209U0 STD. ROT REC93332-00048 C.ROT.
FL200C ETX	2006	REC93311-83280	REC93317-330U2				REC93332-000W1		REC93306-209U0 STD. ROT REC93332-00048 C.ROT.
L200A	1988-89	REC93311-928U5	REC93317-330U2 REC93341-930V2		REC93315-430U8	REC93315-425V3	REC93390-000U2	REC93315-430V5	REC93332-00048
L200B	1990-94	REC93311-928U5	REC93317-330U2 REC93341-930V2			REC93315-425V3	REC93332-000V3 STD. ROT REC93390-000U2 C.ROT.	REC93315-430V5	REC93306-209U0
L200F	1996-98	REC93311-928U5	REC93315-430V5 REC93341-930V2		REC93315-430U8	REC93315-425V3	REC93332-000V3 STD. ROT REC93390-000U2 C.ROT.		REC93306-209U0 STD. ROT REC93332-00048 C.ROT.
L200F ETO	2000	REC93311-928U5	REC93317-330U2 REC93341-930V2		REC93315-430U8	REC93315-425V3	REC93332-000V3 STD. ROT REC93390-000U2 C.ROT.		REC93306-209U0 STD. ROT REC93332-00048 C.ROT.
L200F ETOL	2001-06	REC93311-928U5	REC93317-330U2 REC93341-930V2		REC93315-43061	REC93315-425V3	REC93332-000V3 STD. ROT REC93390-000U2 C.ROT.		REC93306-209U0 STD. ROT REC93332-00048 C.ROT.
L200F ETOX	2001	REC93311-928U5	REC93317-330U2		REC93315-430U8	REC93315-425V3	REC93332-000V3 STD. ROT REC93390-000U2 C.ROT.		REC93306-209U0 STD. ROT REC93332-00048 C.ROT.
LZ200N	2000						REC93390-000U2		REC93390-000U2
LZ200N ETO	2000	REC93311-928U5	REC93317-330U2		REC93315-430U8	REC93315-425V3	REC93332-000V3		REC93306-209U0 STD. ROT REC93332-00048 C.ROT.
LZ200N ETOX	2001-07	REC93311-928U5	REC93317-330U2 REC93341-930V2		REC93315-43061	REC93315-425V3	REC93332-000V3 STD. ROT REC93390-000U2 C.ROT.		REC93306-209U0 STD. ROT REC93332-00048 C.ROT.
LZ200T R	2005						REC93390-000U2		REC93390-000U2
LZ200T XRC	2004-06						REC93390-000U2		REC93390-000U2
LZ200T XRD	2005						REC93390-000U2		REC93390-000U2
Z200N ETO	2000	REC93311-928U5	REC93317-330U2 REC93341-930V2		REC93315-430U8	REC93315-425V3	REC93332-000V3		REC93306-209U0 STD. ROT REC93332-00048 C.ROT.
Z200N ETOL Z200N ETOX	2001-06	REC93311-928U5	REC93317-330U2 REC93341-930V2		REC93315-43061	REC93315-425V3	REC93332-000V3 STD. ROT REC93390-000U2 C.ROT.		REC93306-209U0 STD. ROT REC93332-00048 C.ROT.
Z200P ETOL	2003-06	REC93311-928U5	REC93317-330U2 REC93341-930V2		REC93315-43061	REC93315-425V3	REC93332-000V3		REC93306-209U0
220A	1984-86	REC93311-928U5	REC93317-330U2 REC93341-930V2		REC93315-430U8	REC93315-425V3	REC93332-000V3		REC93306-209U0
225A	1987-89	REC93311-928U5	REC93317-330U2 REC93341-930V2		REC93315-430U8	REC93315-425V3			REC93306-209U0
225B	1990-94	REC93311-928U5	REC93317-330U2 REC93341-930V2		REC93315-430U8	REC93315-425V3	REC93332-000V3		REC93306-209U0
225B	1995	REC93311-928U5	REC93315-430V5			REC93315-425V3	REC93332-000V3		REC93306-209U0
225C	1994	REC93311-83280	REC93317-330U2		REC93315-430U8		REC93332-000W1		REC93306-210U0

		1	2	3	4	5	6	7	8
225C	1995	REC93311-83280	REC93315-430V5						
225D	1996-98	REC93311-928U5	REC93315-430V5 REC93341-930V2		REC93315-430U8	REC93315-425V3	REC93332-000V3		REC93306-209U0
225D ETO	2000	REC93311-928U5	REC93317-330U2 REC93341-930V2		REC93315-430U8	REC93315-425V3	REC93332-000V3		REC93306-209U0
225D ETOL 225D ETOX	2001-03	REC93311-928U5	REC93317-330U2 REC93341-930V2		REC93315-430U8	REC93315-425V3	REC93332-000V3		REC93306-209U0
225G	1999	REC93311-83280	REC93317-330U2		REC93315-43061		REC93332-000W1		REC93306-210U0
225G ETO	2000	REC93311-83280	REC93317-330U2		REC93315-43061		REC93332-000W1		REC93306-210U0
225G ETOL	2001-03	REC93311-928U5	REC93317-330U2		REC93315-43061		REC93332-000W1		REC93306-210U0 REC93306-209U0 STD. ROT REC93332-00048 C.ROT.
F225A ETU	2003-06		REC93317-330U2		REC93315-43061		REC93332-000W1		REC93306-210U0 STD. ROT REC93332-00048 C.ROT.
F225A ETX FL225A ETX	2002-06	REC93311-83280	REC93317-330U2		REC93315-43061		REC93332-000W1		REC93306-210U0 STD. ROT REC93332-00048 C.ROT.
L225C	1994	REC93311-83280	REC93317-330U2		REC93315-430U8		REC93332-000W1		REC93306-210U0
L225C	1995	REC93311-83280	REC93315-430V5				REC93332-000W1		REC93306-210U0
250A	1990-94	REC93311-83280	REC93317-330U2		REC93315-430U8		REC93332-000W1		REC93306-210U0
250A	1995-98	REC93311-83280	REC93315-430V5				REC93332-000W1		REC93306-210U0
250A ETO	2000	REC93311-83280	REC93317-330U2		REC93315-430U8		REC93332-000W1		REC93306-210U0
250A ETOX	2001-06	REC93311-83280	REC93317-330U2		REC93315-43061		REC93332-000W1		REC93306-210U0
250B	1997-98	REC93311-83280	REC93317-330U2		REC93315-430U8		REC93332-000W1		REC93306-210U0
250B ETO	2000	REC93311-83280	REC93317-330U2		REC93315-430U8		REC93332-000W1		REC93306-210U0
250B ETOX	2001-03	REC93311-83280	REC93317-330U2		REC93315-430U8		REC93332-000W1		REC93306-210U0
250G ETOX	2006	REC93311-83280	REC93317-330U2		REC93315-43061		REC93332-000W1		REC93306-210U0
F250A ETU	2006	REC93311-83280	REC93317-330U2				REC93332-000W1		REC93306-210U0 REC93306-209U0 STD. ROT REC93332-00048 C.ROT.
F250A ETX FL250A ETU FL250 ETX	2006	REC93311-83280	REC93317-330U2				REC93332-000W1		REC93306-210U0 REC93306-209U0 STD. ROT REC93332-00048 C.ROT.
L250A	1990-94	REC93311-83280	REC93317-330U2		REC93315-430U8		REC93332-000W1	REC93315-430U8	REC93315-430U8
L250A	1995-98	REC93311-83280	REC93315-430V5				REC93332-000W1		REC93306-210U0
L250A ETO	2000	REC93311-83280	REC93317-330U2		REC93315-430U8		REC93332-000W1		REC93306-210U0
L250A ETOX	2001-06	REC93311-83280	REC93317-330U2		REC93315-43061		REC93332-000W1		REC93306-210U0
L250B	1997-98	REC93311-83280	REC93317-330U2		REC93315-430U8		REC93332-000W1		REC93306-210U0
L250B ETO	2000	REC93311-83280	REC93317-330U2		REC93315-430U8		REC93332-000W1		REC93306-210U0
L250B ETOX	2001-03	REC93311-83280	REC93317-330U2		REC93315-430U8		REC93332-000W1		REC93306-210U0
L250G ETOX	2006	REC93311-83280	REC93317-330U2		REC93315-43061		REC93332-000W1		REC93306-210U0 REC93306-209U0 STD. ROT REC93332-00048 C.ROT.
LZ250D EOX	2003-06	REC93311-83280	REC93317-330U2		REC93315-43061		REC93332-000W1		REC93306-209U0 STD. ROT REC93332-00048 C.ROT.
Z250D ETOU	2003	REC93311-83280	REC93317-330U2		REC93315-43061		REC93332-000W1		REC93306-209U0 STD. ROT REC93332-00048 C.ROT.
Z250D ETOX Z250F ETOL	2003-06	REC93311-83280	REC93317-330U2		REC93315-43061		REC93332-000W1		REC93306-209U0 STD. ROT REC93332-00048 C.ROT.
LZ300A ETOX Z300A ETOU Z300A ETOX	2004-06	REC93311-83280	REC93317-330U2				REC93332-000W1		REC93306-209U0 STD. ROT REC93332-00048 C.ROT.

# SISTEMA DE PROPULSIÓN PROPULSION SYSTEM

# SISTEMA DI PROPULSIONE SYSTEME DE PROPULSION

HÉLICES ALUMINIO E INOXIDABLE DE 3 Y 4 PALAS    3 & 4 BLADE ALUMINIUM & SS PROPELLERS    ELICHE ALLUMINIO E INOX DA 3 E 4 PALE    HELICE ALUMINIUM ET INOX 3 ET 4 PALES

CÓDIGO DE REFERENCIAS    PART NO. CODING SYSTEM    SISTEMA DI CODICE    CODAGE DES REFERENCES

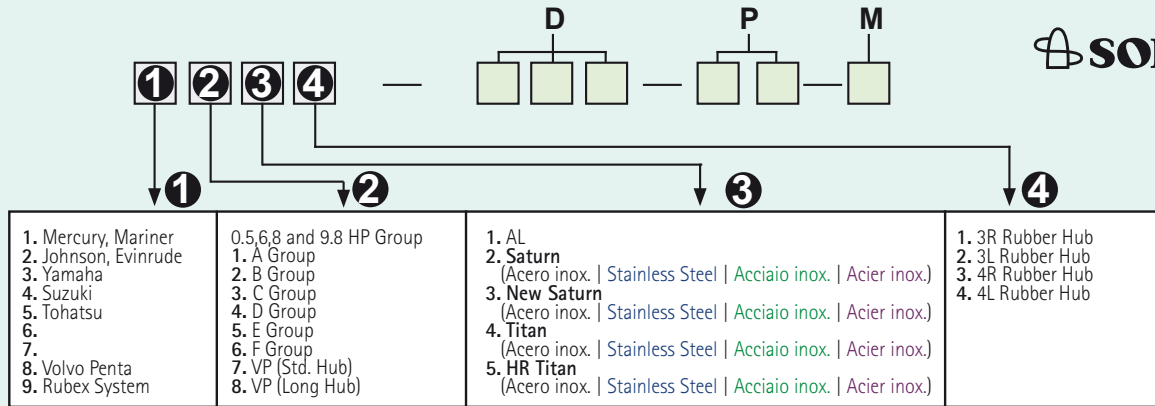

Ejemplo | Note | Esempio | Exemple

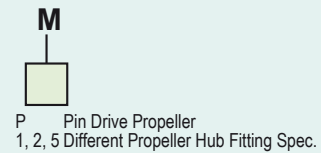
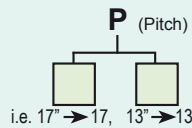
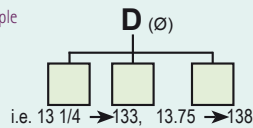

## AMITA 3

Hélice de aluminio de 3 palas con núcleo de goma de gran resistencia.

3 blade aluminum propeller with heavy duty rubber hub.

Eliche di alluminio a 3 pale con mozzi in gomma ad alta resistenza.

Hélice en aluminium 3 pales avec moyeu en caoutchouc



## AMITA 4

Hélices de aluminio de 4 palas con núcleo de goma de gran resistencia. Van muy suaves a poca velocidad y hace el barco muy manejable con la mar picada.

4 Blade aluminum propeller with heavy duty rubber hub. Smoother low speed makes the offshore boating activity much easier.

Eliche di alluminio a 4 pale con mozzo in gomma ad alta resistenza. Molto morbido a bassa velocità e rende la barca molto maneggevole con mare cattivo.

Hélice en aluminium 4 pales avec moyeu en caoutchouc. Permet d'aller doucement à basse vitesse et rend le bateau très maniable lorsque la mer est agitée



## LEXOR

Hélices de acero inoxidable de 3 palas. Gran diámetro del área de las palas para barcos pesados. Gran rendimiento en alta velocidad sin sacrificar las velocidades medias. Excelente ahorro de combustible.

Three blade stainless steel propeller. Large diameter and blade area for big boat loads. Great high speed performance without sacrificing mid-range speeds. Excellent fuel economy.

Eliche di acciaio inox a 3 pale. Grande diametro delle pale per imbarcazioni pesanti. Grandi prestazioni ad alta velocità senza sacrificare velocità medie. Eccellente risparmio di carburante.

Hélice inox 3 Pales, grand diamètre pour bateaux lourds. Excellentes performances à grande vitesse sans sacrifier les vitesses moyennes. Excellente économie de carburant.



## NEW SATURN

Hélices de acero inoxidable de 3 palas. Ofrece buena aceleración y rendimiento. Tamaño más pequeño que ofrece un diámetro extragrande.

Three blade stainless steel propeller. Offers good acceleration & all-round performance. Smaller pitch sizes offered in extra large diameter with increased blade area.

Eliche di acciaio inox a 3 pale. Buona accelerazione. Piccole dimensioni che offre un più grande diametro.

Hélice inox 3 pales, offrant de bonnes accélérations et performances. Taille de pas réduite pour les modèles de grands diamètres avec une surface de pale plus importante.

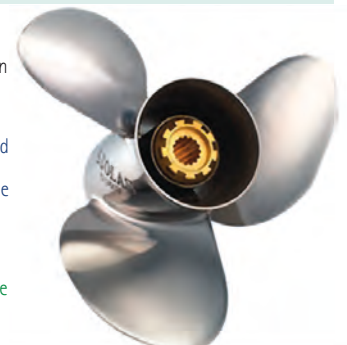



GUÍA DE HÉLICES  
CON NÚCLEO INTEGRADO

PROPELLERS APPLICATION  
WITH RUBBER HUB

GUIDA ELICHE  
CON MOZZO

GUIDE DES HELICES ET  
MOYEUX

	2T STROKES	4T STROKES	R.O. OEM	A	G	B	D	P	R	AL	INOX STAINLESS STEEL	
2.5 - 6 HP	✓	✓	6L5-45949-00-EL	9			7 <sup>1/4</sup>	5	R	SOL3011-073-05S	AMITA 3	
			6E0-45943-01-EL				7 <sup>1/2</sup>	7	R	SOL3011-075-07S	AMITA 3	
			6L5-45943-00-EL				7 <sup>1/4</sup>	6	R	PAF2.6-03010000		
			6E0-45943-01-EL				7 <sup>1/2</sup>	7	R	PAF4-03070000		
6.8 HP F6, F8, F9.9	✓	✓	6G1-45947-00-EL	7		3	8 <sup>1/2</sup>	7	R	SOL3011-085-07	AMITA 3	
			6G1-45943-00-EL				8 <sup>1/2</sup>	8	R	SOL3011-085-08	AMITA 3	
			6G1-45941-00-EL				8 <sup>1/2</sup>	9	R	SOL3011-085-09	AMITA 3	
8 HP (1976-83)	✓		647-45943-00-EL	PIN		3	8 <sup>3/4</sup>	8	R	SOL2011-083-08P	AMITA 3	
							9	7	R	SOL3011-090-07-P	AMITA 3	
9.9 15 T8 T9.9 F9.9 (2000-07) F15 F20 Hight Thrust	✓	✓	683-45947-00-EL	8	2 1/2	3	9 <sup>1/4</sup>	7	R	SOL3111-093-07	AMITA 3	
			683-45945-00-EL				9 <sup>1/4</sup>	8	R	SOL3111-093-08	AMITA 3	
			683-45942-00-EL				9 <sup>1/4</sup>	9		SOL3111-093-09	AMITA 3	
			683-45943-00-EL				9 <sup>1/4</sup>	10	R	SOL3111-093-10	AMITA 3	
			63V-45943-10-00				9 <sup>1/4</sup>	11	R	SOL3111-093-11	AMITA 3	
			683-45941-00-00				9 <sup>1/4</sup>	11	R	PAF15-06090000		
							9 <sup>1/4</sup>	12	R	SOL3111-093-12	AMITA 3	
20 (1996-97) 25 (1980 +) 30 (1979 +) F25	✓	✓	664-45941-01-EL	10	3	3	9 <sup>7/8</sup>	9	R	SOL3211-099-09		
			664-45945-00-EL				9 <sup>7/8</sup>	10	R	SOL3211-099-10		
			664-45947-01-EL				9 <sup>7/8</sup>	11	R	SOL3211-099-11		
			664-45954-00-EL				9 <sup>7/8</sup>	12	R	SOL3211-099-12		
			664-45949-02-EL				9 <sup>7/8</sup>	13	R	SOL3211-099-13		
							10 <sup>3/4</sup>	10	R		SOL3231-108-10	NEW SATURN
							10 <sup>1/2</sup>	11	R		SOL3231-105-11	NEW SATURN
	10 <sup>1/4</sup>	12	R		SOL3231-103-12	NEW SATURN						
					10 <sup>1/8</sup>	13	R		SOL3231-101-13	NEW SATURN		
40 48 50 (NO T50) 55 60 (-1991) F30 F40 (1999+) F50 (1995+) F60 (1999+)			663-45956-01-EL	13	3 1/2	3	12 <sup>1/4</sup>	9	R	SOL3311-121-09	AMITA 3	
			663-45947-02-EL				11 <sup>5/8</sup>	11	R	SOL3311-116-11	AMITA 3	
			663-45952-02-EL				11 <sup>3/4</sup>	12	R	SOL3311-114-12	AMITA 3	
			663-45945-02-EL				11 <sup>1/8</sup>	13	R	SOL3311-111-13	AMITA 3	
			69W-45941-00-EL				11 <sup>1/8</sup>	13	R	PAT40-04070000		
			663-45958-01-EL				11 <sup>1/4</sup>	14	R	SOL3311-111-14	AMITA 3	
			663-45943-02-EL				11	15	R	SOL3311-110-15	AMITA 3	
			663-45949-01-EL				10 <sup>3/4</sup>	16	R	SOL3311-110-16	AMITA 3	
			663-45941-01-EL				11	17	R	SOL3311-110-17	AMITA 3	
							11 <sup>7/8</sup>	10	R		SOL3331-119-10	NEW SATURN
							11 <sup>5/8</sup>	11	R		SOL3331-116-11	NEW SATURN
							11 <sup>3/8</sup>	12	R		SOL3331-114-12	NEW SATURN
							11 <sup>1/8</sup>	13	R		SOL3331-111-13	NEW SATURN
	11 <sup>1/8</sup>	14	R		SOL3331-111-14	NEW SATURN						
40 HP				PIN		3	11 <sup>1/2</sup>	10	R	SOL3311-115-10-P	AMITA 3	
							11 <sup>1/2</sup>	11	R	SOL3311-115-11-P	AMITA 3	
							11 <sup>1/2</sup>	12	R	SOL3311-115-12-P	AMITA 3	
60 (1992+) 70 (1984+) 75 (1994+) 80 (1978-89) 85 (1991-97) 90 (1984+) 115 (1984+) 130 (1984+) F75 (2003+) F80 (1999+) F90 (2003+) F100 (1999+) F115 (2000+) T50 (1996+) T60 (2003+) F70 (2010+)			6E5-45954-00-EL	15	4 1/4	3	14	11	R	SOL3411-140-11	AMITA 3	
			6E5-45949-00-EL				13 <sup>1/4</sup>	13	R	SOL3411-138-13	AMITA 3	
							13 <sup>3/8</sup>	13	L	SOL3412-138-13	AMITA 4	
			6E5-45947-00-EL				13 <sup>1/2</sup>	15	R	SOL3411-135-15	AMITA 3	
							13 <sup>1/2</sup>	15	L	SOL3413-130-15	AMITA 4	
							13 <sup>1/2</sup>	15	L	SOL3412-135-15		
			6E5-45945-00-EL				13 <sup>1/4</sup>	17	R	SOL3411-133-17	AMITA 3	
							13 <sup>1/4</sup>	17	L	SOL3413-128-17	AMITA 4	
							13 <sup>1/4</sup>	17	L	SOL3412-133-17		
			6E5-45941-00-EL				13	19	R	SOL3411-130-19	AMITA 3	
							13	19	R	SOL3413-125-19	AMITA 4	
			6E5-45943-00-EL				13	21	R	SOL3411-130-21	AMITA 3	
							13	21	R	SOL3413-125-21	AMITA 4	
			688-45978-60-98				13 <sup>1/2</sup>	15	R		SOL3431-135-15	NEW SATURN
			688-45930-02-98				13	17	R		SOL3431-133-17	NEW SATURN
							13	17	L		SOL3432-133-17	NEW SATURN
			688-45970-03-98				13	19	R		SOL3431-130-19	NEW SATURN
	13	19	L		SOL3432-130-19	NEW SATURN						
688-45972-02-98	13	21	R		SOL3431-130-21	NEW SATURN						



	2T STROKES	4T STROKES	R.O. OEM	A	G	B	D	P	R	AL	INOX STAINLESS STEEL	
			6G5-45941-00-98				15	15	R	SOL3511-150-15 SOL3513-148-15		
			6G5-45952-00-98				15	15	L	SOL3512-150-15 SOL3514-148-15	AMITA 3 AMITA 4	
			6G5-45947-01-98				14,8	17	R	SOL3511-148-17 SOL3513-145-17	AMITA 3 AMITA 4	
			6K1-45947-00-98				14,8	17	L	SOL3512-148-17 SOL3514-145-17	AMITA 3 AMITA 4	
			6G5-45945-01-98				14,5	19	R	SOL3511-145-19 SOL3513-143-19	AMITA 3 AMITA 4	
			6K1-45945-01-98				14,5	19	L	SOL3512-145-19 SOL3514-143-19	AMITA 3 AMITA 4	
			6G5-45949-00-98				14,3	21	R	SOL3511-143-21 SOL3513-140-21	AMITA 3 AMITA 4	
150 (1986+)							14,3	21	L	SOL3512-143-21 SOL3514-140-21	AMITA 3 AMITA 4	
175 (1984+)												
200 (1984+)												
200VMAX (2001+)			6G5-45949-00-98				14,2	23	R	SOL3511-142-23	AMITA 3	
220 (1987-88)							14,2	23	L	SOL3512-142-23	AMITA 3	
225 (1986+)												
250 (1990+)			6G5-45941-00-98				15 <sup>3/4</sup>	15	R			SOL3571-158-15 LEXOR
225VMAX (2001+)			6G5-45952-00-98				15 <sup>3/4</sup>	15	L			SOL3572-158-15 LEXOR
300 (2004+)			6G5-45947-01-98				15 <sup>1/2</sup>	17	R			SOL3571-155-17 LEXOR
F150 (2004+)			6K1-45947-00-98				15 <sup>1/2</sup>	17	L			SOL3572-155-17 LEXOR
F200 (2002+)			6G5-45945-01-98			3	15 <sup>1/4</sup>	19	R			SOL3571-153-19 LEXOR
F225 (2002+)			6K1-45945-01-98				15 <sup>1/4</sup>	19	L			SOL3572-153-19 LEXOR
F250 (2005+)			6G5-45949-00-98				15	21	R			SOL3571-150-21 LEXOR
F300 (2003+)							15	21	R			SOL3572-150-21 LEXOR
dentro-fueraborda			6G5-45949-00-98				14	23	R			SOL3571-148-23 LEXOR
Intro-outboard							14	23	L			SOL3572-148-23 LEXOR
Intro-Fuoribordo							14	25	R			SOL3571-145-25 LEXOR
Intro-horsbord							14	27	R			SOL3571-145-27 LEXOR
3.0L-7.4L			6G5-45970-02-98				15 <sup>1/4</sup>	15	R			SOL3531-145-15 NEW SATURN
			6K1-45970-01-98				15 <sup>1/4</sup>	15	L			SOL3532-145-15 NEW SATURN
			6G5-45978-03-98				13 <sup>3/4</sup>	17	R			SOL3531-143-17 NEW SATURN
			6K1-45978-02-98				13 <sup>3/4</sup>	17	L			SOL3532-143-17 NEW SATURN
			6G5-45974-03-98				13 <sup>3/4</sup>	19	R			SOL3531-140-19 NEW SATURN
			6K1-45974-02-98				13 <sup>3/4</sup>	19	L			SOL3532-140-19 NEW SATURN
			6G5-45972-02-98				13 <sup>3/4</sup>	21	R			SOL3531-140-21 NEW SATURN
			6K1-45972-01-98				13 <sup>3/4</sup>	21	L			SOL3532-140-21 NEW SATURN
			6G5-45976-01-98				13 <sup>3/8</sup>	23	R			SOL3531-140-23 NEW SATURN
			6K1-45976-00-98				13 <sup>3/8</sup>	23	L			SOL3532-140-23 NEW SATURN

HÉLICES PARA NÚCLEO INTERCAMBIABLE

PROPELLERS FOR INTERCHANGEABLE HUB

ELICHE PER MOZZO INTERCAMBIABILE

HELICES AVEC MOYEU INTERCHANGEABLE

	B	D	P	R	AL
<b>C</b> 30-75 HP	3	12.1	9	R	SOL9311-121-09
		12	10	R	SOL9311-120-10
		11-6	11	R	SOL9311-116-11
		11.4	12	R	SOL9311-114-12
		11.1	13	R	SOL9311-111-13
		11.1	14	R	SOL9311-111-14
<b>D</b> 40-140 HP	3	11	15	R	SOL9311-110-15
		14	9	R	SOL9411-140-09
		14	11	R	SOL9411-140-11
		13.75	13	R	SOL9411-138-13
		13.50	15	R	SOL9411-135-15
		13.25	17	R	SOL9411-133-17
<b>E</b> 135-350 HP	3	13.2	19	R	SOL9411-132-19
		13.2	21	R	SOL9411-132-21
		15.5	11	R	SOL9511-155-11
		15.3	13	R	SOL9511-153-13
		16	13	R	SOL9511-160-13
		15	15	R	SOL9511-150-15
		15	15	L	SOL9511-150-15
		14.8	17	R	SOL9511-148-17
		14.8	17	L	SOL9511-148-17
		14.5	19	R	SOL9511-145-19
14.5	19	L	SOL9511-145-19		
14.3	21	R	SOL9511-143-21		
14.3	21	L	SOL9511-143-21		

	B	D	P	R	INOX STAINLESS STEEL
<b>C</b> 30-75 HP	3	11 <sup>5/8</sup>	11	R	SOL9331-116-11
		11 <sup>3/8</sup>	12	R	SOL9331-114-12
		11 <sup>1/8</sup>	13	R	SOL9331-111-13
		11 <sup>1/8</sup>	14	R	SOL9331-111-14
		11	15	R	SOL9331-110-15
		<b>D</b> 40-140 HP	3	13 <sup>3/4</sup>	13
13 <sup>3/4</sup>	13			L	SOL9432-138-13
13 <sup>1/2</sup>	15			R	SOL9431-135-15
13 <sup>1/2</sup>	15			L	SOL9432-135-15
13 <sup>1/4</sup>	17			R	SOL9431-133-17
13 <sup>1/4</sup>	17			L	SOL9432-133-17
<b>E</b> 90-140 HP	3	13	19	R	SOL9431-130-19
		13	19	L	SOL9432-130-19
		13	21	R	SOL9431-130-21
		14 <sup>1/2</sup>	15	R	SOL9531-145-15
		14 <sup>1/2</sup>	15	L	SOL9532-145-15
		14 <sup>1/4</sup>	17	R	SOL9531-143-17
		14 <sup>1/4</sup>	17	L	SOL9532-143-17
		14	19	R	SOL9531-140-19
		14	19	L	SOL9532-140-19
		14	21	R	SOL9531-140-21
<b>E</b> 135-350 HP	3	14	21	L	SOL9532-140-21
		14	23	R	SOL9531-140-23
		14	23	L	SOL9532-140-23
		15 <sup>3/4</sup>	15	R	SOL9571-158-15
		15 <sup>3/4</sup>	15	L	SOL9572-158-15
		15 <sup>1/2</sup>	17	R	SOL9571-155-17
		15 <sup>1/2</sup>	17	L	SOL9572-155-17
		15 <sup>1/4</sup>	19	R	SOL9571-153-19
		15 <sup>1/4</sup>	19	L	SOL9572-153-19
		15	21	R	SOL9571-150-21
15	21	L	SOL9572-150-21		
14 <sup>3/4</sup>	23	R	SOL9571-148-23		
14 <sup>3/4</sup>	23	L	SOL9572-148-23		
14 <sup>1/2</sup>	25	R	SOL9571-145-25		
14 <sup>1/2</sup>	25	L	SOL9572-145-25		

**RUBEX**





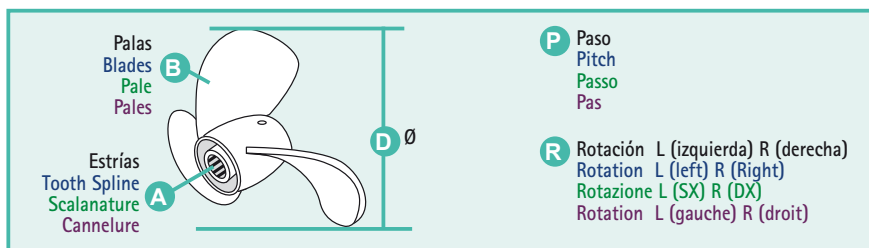

Núcleo intercambiable (no incluido).  
Interchangeable hub (not included).  
Mozzo intercambiable (non incluso).  
Moyaux interchangeable (non inclus)



NÚCLEO INTERCAMBIABLE INTERCHANGEABLE HUB

MOZZO INTERCAMBIABILE

MOYEU INTERCHANGEABLE

	  		REF	
	2T STROKES	4T STROKES		
F30 (2001-05) F40 (1999+); F50 (1995+) F60 (1999+)	✓		13 SOLRBX-117	C
40HP et 50HP (not T50), (1984+) 48HP (1995+) 55HP (1976-95) 60HP (1976-91)			13 SOLRBX-117	C
T50 (1996+)			15 SOLRBX-108	D
60-100 HP (1984+)	✓	✓	15 SOLRBX-108	D
80-140HP, (1978-83)			15 SOLRBX-102	D
115HP FS115		✓	15 SOLRBX-103	D
130HP, (1984+)			15 SOLRBX-103	D
150-175HP, (1978-83)			15 SOLRBX-102	E
150-300HP, (1984+)			15 SOLRBX-103	E
225 EFI		✓	15 SOLRBX-103	E
F300, F350			17 SOLRBX-127	E+
300, 350HP, V8		✓	17 SOLRBX-127	E+
Stern drives, (1989-93)			15 SOLRBX-103	E



**RUBEX**

GUÍA DE RECAMBIOS DE HELICE

PROPELLER SPARE PARTS

GUIDA RICAMBIO ELICHE

GUIDE DES PIECES POUR HELICE

	1	2	3	4	5
F2.5A, F4B, F5A, F6C	PAF4-03000025		PAF4-03000026	PAF4-03080000	PAGB/T91-1.6X12
F8C, F8F			REC90201-10M01	REC90171-10M01	REC91490-30025
F9.9J			REC90201-10M01	REC90171-10M01	REC91490-30025
F15C, F20B	REC6E7-45987-00		REC90201-10M01	REC90171-10M01	REC91490-30025
F25D	REC6L2-45987-00	REC689-45997-00	PAGB/T97.1-14	REC90171-14013-00	REC91490-30030
FT25F	REC663-45987-00		REC92990-16200	REC90171-16011	REC91490-30030
F30, F40F, F50H, F60F	REC663-45987-00	REC66T-45997-00	REC90389-22M01	REC90171-16011	REC91490-30030
FT50J, FT60G	REC688-45987-00	REC67F-45997-00	REC90389-25M00	REC90171-16011	REC91490-30030
F70A, F80B, F100D	REC688-45987-00	REC67F-45997-00	REC90389-25M00	REC90171-16011	REC91490-30030
F(L) 115A, F(L) 115B, F130A, F(L)150A, F(L)150D, F175A, F(L)200F	REC6E5-45987-00	REC688-45997-00	REC92990-18200	REC90171-18M04	REC91490-40030
F(L)225F, F(L)250D, F(L)300B (4.2L) V6		REC688-45997-00	REC92990-18200	REC90171-18M04	REC91490-40030

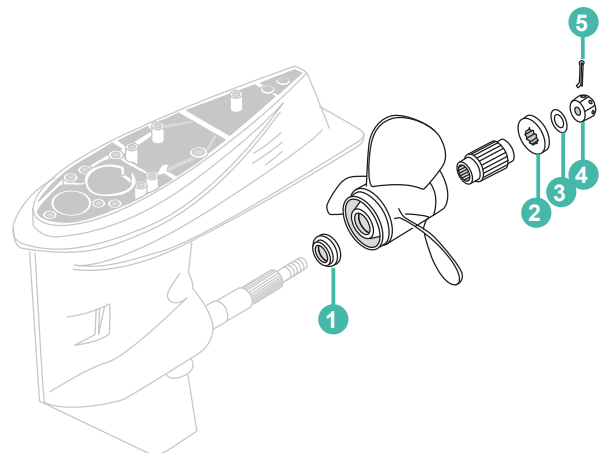

YAMAHA

RECAMBIOS MARINOS



# REF --> RO / OEM

REF	R.O. / OEM	
<b>C</b>		
CEF500302	6G1-44352-00	143
CEF500316	6H3-44352-00	143
CEF500320	682-44352-03	143
CEF500321	662-44352-01	143
CEF500322	6L5-44352-00	143
CEF500323	688-44352-03	143
CEF500324	646-44352-01	143
CEF500325	6E0-44352-00	143
CEF500326	689-44352-02	143
CEF500352	6F5-44352-00	143
CEF500363	63V-44352-01	143
CEF500364	67F-44352-00	143
CEF500368	68T-44352-00	143
CEF500371	6E5-44352-01	143
CEF500384	6L2-44352-00	143
CEF500385G	6H4-44352-02	143
CEF500389N	6AW-44352-00	143-155
CEF500401N	6CE-44352-00	143
CHAL77JC4		108
CHAL82C		108
CHAL90C		108
CHAQL77JC4		108
CHAQL78C		108
CHAQL82C		108
CHAQL86C		108
CHARA8HC		108
CHARC12YC		108
CHARC9YC4		108
CHAZ9Y		108
CM15008	66M-11325-00	159
CM15008A	66M-11325-00	159
CM15026	6E5-11325-00	158-169
		65-70-72-73-158-169-187-209-213
CM15026A	6E5-11325-00	158
CM3082523	689-11325-00	158
CM41106-ZW000	41106-ZW-000	158
CM42121		159
CM43107M	677-45251-00	169
CM61A-11325-00	61A-11325-00	161
CM61A-45371	61A-45371-00	160-169-383
CM61A-45371-00A	61A-45371-00	160-169-331-335-337
CM61N-45251-01	61N-45251-01	160-169-291-351-355
CM61N-45251-01A	61N-45251-01	65-66-160-169
CM62Y-11325-00	62Y-11325-00	158
		65-66-67-68-69-158-197-203-205-207
CM62Y-11325-00A	62Y-11325-00	159-169
CM63D-45251-01	63D-45251-01	169
CM63D-45251-01A		169
CM63P-11325-01	63P-11325-00	161
CM63P-11325-01	63P-11325-01	161
CM63P-11325-01		169
CM63P-11325-01A	63P-11325-00	161
CM63P-11325-01A	63P-11325-01	161-211-214
CM63P-11325-01A		70-71-73
CM63P-11325-11	63P-11325-11	161-169
CM63P-11325-11A	63P-11325-11	71-73-161-211
		169-357-359-361
CM664-45371-01	664-45371-01	361
CM664-45371-01	664-45371-01-00	353
CM664-45371-01	664-45371-01A	160
CM664-45371-01A	664-45371-01A	66-160-169
CM66M-11325-00A		65
CM66M-45371-00	66M-45371-00	159-169-291
CM679-45251-00	679-45251-00	160
CM679-45251-00A	679-45251-00	160
CM67C-45251-00	67C-45251-00	158-169-361
		66-67-69-158-299-303-307-311
CM67C-45251-00A	67C-45251-00	160-169
CM67C-45371-00	67C-45371-00	160-169
		66-67-68-69-160-169-299-303-307-311
CM67C-45371-00A	67C-45371-00	159
CM67F-11325-00	67F-11325-00	161
CM67F-11325-01	67F-11325-01	161
CM67F-11325-01A	67F-11325-01	70-71-72-73-161-211-213
CM67F-45371-00	67F-45371-00	70-161
CM67F-45371-00A	67F-45371-00	68-69-161-315-319
CM688-45251-01	688-45251-01	158-169
CM688-45251-01A	688-45251-01	67-68-69-158-169
CM688-45371-02	688-45371-02	371
CM688-45371-02	688-45371-02	160-169
CM688-45371-02	688-45371-02-00	373
CM688-45371-02A		160-169
CM689-11325-00A	689-11325-00	158
CM68T-11325-00	68T-11325-00	161
CM68T-11325-00A	68T-11325-00	71-72-73-161-211
CM68T-45251-00	68T-45251-00	158-169
CM68T-45251-00A	68T-45251-00	64-65-158-169-289
CM68V-11325-01	68V-11325-01	158
CM68V-11325-01A	68V-11325-01	158
CM68V-11325-01A	68V-11325-02	209
CM68V-11325-01A		69
CM69L-45371-00	69L-45371-00	160-169
CM69L-45371-00A	69L-45371-00	160-169
CM6AW-45251-00	6AW-45251-00	161-169

REF	R.O. / OEM	
CM6AW-45251-00A	6AW-45251-00	72-161-169
CM6AW-45373-00	6AW-45373-00	161-169
CM6AW-45373-00A	6AW-45373-00	161-169-341
CM6AW-45619-00	6AW-45619-00	161
CM6AW-45619-00A	6AW-45619-00	161-341
CM6BL-11325-00	6BL-11325-00	161
CM6BL-11325-00A	6BL-11325-00	66-161-195
CM6E0-45251-11	6E0-45251-11	347
CM6E0-45251-11	6E0-45251-11-00	158
CM6E0-45251-11	6E0-45251-11	169
CM6E0-45251-11A	6E0-45251-11-00	65-66-67-68-69-158-169
CM6E5-45251-00	6E5-45251-00	158-169
CM6E5-45251-00A		66-158-169
CM6E5-45371-01A	6E5-45371-00	323
CM6E5-45371-01A	6E5-45371-01	161-379
CM6E5-45371-01A		70-71-169
CM6E5-45371-10	6E5-45371-10	160
CM6E8-45251-00	6E8-45251-00	159
CM6E8-45251-01	6E8-45251-02	159-169
CM6G1-45251-02	6G1-45251-02	159-169
CM6G1-45251-03	6G1-45251-03	159
CM6G1-45251-03	6GH-45251-00	159
CM6G1-45251-03	6N0-WG525-00	159
CM6G1-45251-03	6G1-45251-03	169
CM6G5-45251-01	6G5-45251-01	158-169
CM6G5-45251-01A	6G5-45251-01	70-158-169
CM6G8-11325-00	6G8-11325-00	159-169-181
		65-159-180-187-195-201-203-205
CM6G8-11325-00A	6G8-11325-00	159-169
CM6G8-45251-01	6G8-45251-00	158-169
CM6H1-45251-01	6H1-45251-01	158-169
CM6H1-45251-01A	6H1-45251-01	158
CM6H1-45251-02	6H14525102	158-169
CM6H1-45251-02A	6H14525102	69-70-71-158-169
CM6H3-11325-01A	6H3-11325-01	241
CM6J9-45371-01	6J9-45371-01	160-169
CM6J9-45371-01A	6J9-45371-01	72-160-169-327
CM6K1-45371-00	6K1-45371-00	161-169
CM6K1-45371-00A	6K1-45371-00	161-169
CM6K1-45371-02	6J9-45371-02	160-169
CM6K1-45371-02A	6J9-45371-02	72-160-169
CM6L5-45251-02	6L5-45251-02	159-169-343
CM6L5-45251-02	6L5-45251-03	345
CM6L5-45251-02A	68D-G5251-00	287
CM6L5-45251-02A	6L5-45251-02	159
CM6L5-45251-02A		64-169
CM6T4-45836-00	6T4-45836-00	159
CM6T5-45371-00	6T5-45371-00	161
CM6T5-45373-00	6T545373-00	159
CM6U0-45251-00	6U0-45251-00	159-169
CM6U4-45251-00	6U4-45251-00	158-169
CM825171		158
CM82795M		160
CM82795MA		160
CM85007	688-11325-00	160
CM85007A	688-11325-00	160
CMY150CRKITA		71-162
CMY150CRKITEM		162
CMY150KITA		71-162
CMY150KITM		162
CMY200250KITA		72-73-162
CMY200250KITM		162
CMY200300KITA		162
CMY300350KITA		73-162
CMY300350KITM		162
CMY300350XPKITA		73-162
CMY300350XPKITM		162
CMY4050KITA		162
CMY4050KITM		162
CMY4060KITA		162
CMY4060KITM		162
CMY6090KITA		162
CMY6090KITM		162
CMY80100KITA		162
CMY80100KITM		162
CMYHP200300KITA		162
<b>G</b>		
GS11290		121
GS11291		121
GS11292		121
GS11294		121
GS30435		80
GS31001		80
GS31002		80
GS31020		77
GS31064		77
GS31065	YMM-2FE10-00	79
GS31066	YMM-2FS08-00	79
GS31067	YMM-2FS10-00	79
GS31068		76
GS31069		76
GS31073		77
GS31074	6Y1-24305-05-00	76
GS31074	6Y1-24305-06	76
GS31074	6Y1-24305-06-00	76
GS31074	6YL-24305-01-00	76
GS31075	6G1-24305-00	76
GS31075	6G1-24305-01	76
GS31075	6G1-24305-02	76

REF	R.O. / OEM	
GS31075	6G1-24305-02-00	76
GS31075	6G1-24305-03	76
GS31075	6G1-24305-03-00	76
GS31075	6G1-24305-04	76
GS31075	6G1-24305-04-00	76
GS31075	6G1-24305-05	76
GS31075	6G1-24305-05-00	76
GS31075	6G1-24305-0500	76
GS31075	6Y1-24305-00	76
GS31075	6Y1-24305-01	76
GS31075	6Y1-24305-02	76
GS31075	6Y1-24305-05-00	76
GS31075	6Y1-24305-06-00	76
GS31075	6YL-24305-01-00	76
GS31076	6E5-24305-05-00	76
GS31076	6E5-24305-06	76
GS31076	6E5-24305-06-00	76
GS31076	6Y2-24305-05-00	76
GS31076	6Y2-24305-06-00	76
GS31076	6YK-24305-01-00	76
GS31090	6Y2-24360-52	74
GS31092		77
GS31095		74
GS31096		74
GS31097		74
GS31099		74
GS31155		79
GS31156		79
GS31157		79
GS31166	YMM-2FE08-00	79
GS31183	6Y1-24360-52-00	74
GS31183	6Y1-24360-52-01	74
GS31183	6Y1-24360-52-02	74
GS31183	6Y1-24360-52-51	74
GS31183	6Y1-24360-52-52	74
GS31187	6Y1-24360-52	74
GS31031	90890-56878	75
GS35032	90790-77001	75
GS40015	YMD-RBOX-00-10	127
GS41084	6E5-61301-00	130
GS41084	6E5-61301-01	130
<b>N</b>		
NGKB7HS	94702-00040	220-235-239
NGKB7HS-10	94702-00217	225-229
NGKB7HS-10	94702-00271	227
NGKB8HS	94702-00041	239
NGKB8HS-10	90472-00247	243
NGKB8HS-10	94702-00160	239
NGKBKR6EUKU	94702-00405-00	108
NGKBKR7EUKU	94702-00404-00	108
NGKBPR7HS	94702-00248	175
NGKBR5HS	94702-00249-00	108
NGKBR6FS	94701-00365-00	108
NGKBR6HS	94701-00248-00	108
NGKBR6HS	94702-00248	64-173
NGKBR6HS-10	94702-00274	64-65-180-223
NGKBR6HS-10	94702-00274-00	108
NGKBR7HS	94701-00110	108
NGKBR7HS	94701-00110-10	108
NGKBR7HS	94702-00272	221-233
NGKBR7HS-10	94702-00271	223-229-231-237
NGKBR7HS-10	94702-00271-00	108
NGKBR8ES	94701-00204	108
NGKBR8ES-11	94702-00396	108
NGKBR8HS	94701-00195	108
NGKBR8HS	94701-00195-00	108
NGKBR8HS-10	94702-00247	237-241-245
NGKBR8HS-10	94702-00247-00	108
NGKBR8HS-10	94702-00271	247
NGKBR9HS-10	94701-00309-00	108
NGKBR9HS-10	94702-00309	245
NGKCR5HSB	94701-00300-00	108
NGKCR6HS	94701-00282	181
NGKCR6HS	94701-00282-00	108
NGKCR6HS	94702-00372-00	108
NGKCR6HSB	94702-00372	64-173-179
NGKCR9EB	94702-00409	108
NGKDPRE5EA-9	94701-00406-00	69-108
NGKDPRE6EA-9	94701-00375	65-66-67-68-197-207
NGKDPRE6EA-9	94701-00375-00	108
NGKDPRE6EB-9	94702-00418	65-66-67-68-69-187-195-201-203
NGKDPRE6EB-9	94702-00418-00	108
NGKDPRE7EA-9	94701-00375	185-191
NGKLF5A-11	94702-00391	69-70-71-72-209-211
NGKLF5A-11	94702-00391-00	108
NGKLF6A-11	94702-00400	70-72-73-213-214
NGKLF6A-11	94702-00400-00	108
NGKLF6A-11	947	

REF	R.O. / OEM	
PA166F-010008	67D-12157-00	173-175-179
PA166F-010009	67D-12151-00	173-175-179
PA166F-010010	7FK-12165-00	173-175-179
PA166F-010011	7FK-12158-00	173-175-179
PAE4-10040100W	703-82563-00	122-128
PAE4-10040100W	703-82563-01	122-128
PAE4-10040100W	703-82563-02	128
PAF15-00000001	63V-45551-00-4D	132
PAF15-00000001	66M-44551-00-4D	132
PAF15-00000002	682-44555-30	135
PAF15-00000003	66M-44557-00	135
PAF15-00000005	66M-45113-00	271
PAF15-00000013	93604-10M03	201-317-351 171-173-283- 289-291-293- 351
PAF15-00000013	93604-12M07	183-217-218- 351
PAF15-00000014	66M-11351-10	233
PAF15-01000001	65F-42537-00	133
PAF15-01000004	90386-30048	133
PAF15-01000006	90386-30M60	133
PAF15-01010001	63V-43131-00	131
PAF15-01010001	63V-43131-01	131
PAF15-01010001	63V-43131-10	131
PAF15-01010007	63V-43145-00	131
PAF15-01010007	90185-22043	131
PAF15-01010007	90185-22M11	131
PAF15-01010100	63V-43111-00-4D	131
PAF15-01010100	63V-43111-01-4D	131
PAF15-01010100	63V-43111-A2-4D	131
PAF15-01010200	63V-43112-00-4D	131
PAF15-01010200	63V-43112-01-4D	131
PAF15-01010200	63V-W4311-00-4D	131
PAF15-01010200	63V-W4311-03-4D	131
PAF15-01010200	63V-WS431-B6-8D	131
PAF15-01010301S	63V-43311-00-4D	131
PAF15-01010301S	63V-43311-01-4D	131
PAF15-01010301S	99999-03116	131
PAF15-01010302	90386-22M15	133
PAF15-01030100	65W-42138-00	131
PAF15-02000005L	66M-44361-10	291
PAF15-02000005S	66M-44361-00	291
PAF15-02000006	63V-44365-10	289-291-351
PAF15-02010000	66M-44514-00-4D	135
PAF15-03000003	66M-45115-00	268
PAF15-04000002	90340-14M00	237-241 191-195-197- 201-203-205- 207-209-211- 213
PAF15-04000002	90340-14M06	195-197-201- 207-209-211- 213-235-237- 239-241
PAF15-04000003	90430-14115	65-66-67-68- 69-70-71-72- 73-191
PAF15-04000003	90430-14M09	173-179-181- 183-195-213- 225-227-229- 231-233
PAF15-04000005	676-11372-00	187
PAF15-04000005	6H1-11372-00	187
PAF15-04010004	66M-41138-00	268
PAF15-05000009	6BL-44391-00	139
PAF15-05000009	6H3-44391-00	139
PAF15-05000009	6H3-44391-01	139
PAF15-05000011	688-24378-00	183-191-195- 197-207
PAF15-05000012	90445-09061	183
PAF15-05000013	90445-09086	183
PAF15-05000014	90445-09104	183-197-207
PAF15-05170300W	6G1-81941-10	111-114
PAF15-06000001	63V-45311-01-4D	351
PAF15-06000002	63V-45215-00	293-350
PAF15-06000002	6G1-45215-00	289
PAF15-06000003	6G1-45214-00	289-293-350
PAF15-06000004	61N-45251-00	295
PAF15-06000006	63V-45536-00	291-292-351
PAF15-06000008	6E8-45587-10	293
PAF15-06000008	6E8-45587-10-13	291-351
PAF15-06000009	6E7-45587-01-30	348
PAF15-06000009	6E8-45587-30	293
PAF15-06000010-1	664-45567-01-10	291-351
PAF15-06000010-1	664-45567-05	349
PAF15-06000010-1	664-45567-01	293
PAF15-06000010-2	664-45567-10	293
PAF15-06000010-2	664-45567-12	349
PAF15-06000010-3	664-45567-20	293
PAF15-06000010-4	664-45567-30	293
PAF15-06000010-5	664-45567-40	349
PAF15-06000010-6	664-45567-50	293
PAF15-06000010-7	664-45567-60	349
PAF15-06000010-7	664-45567-60	293
PAF15-06000014	63V-44328-00	289-291-351
PAF15-06000014	63V-44328-01	293
PAF15-06000015	6E7-45987-01	351
PAF15-06000016	90171-10M01	349
PAF15-06000020-1	90201-15017	293
PAF15-06020005	63V-45375-00	289-291-292- 351
PAF15-06030000L	63V-44150-10	291-351
PAF15-06030000S	63V-44150-00	291-351
PAF15-06040000S	63V-45510-00	291
PAF15-06070002	90501-14M06	291-349-351
PAF15-06070002	90501-150A0	293
PAF15-06080000	683-45361-02-8D	293

REF	R.O. / OEM	
PAF15-06080003	93210-56M80	231-291-293- 351
PAF15-06080006-1	626-45577-00	293-351
PAF15-06080006-1	626-45577-00-01	291-349
PAF15-06080006-2	626-45577-10	293
PAF15-06080006-3	626-45577-00-03	349
PAF15-06080006-3	626-45577-20	293
PAF15-06080006-4	626-45577-30	293
PAF15-06080006-5	626-45577-00-05	349
PAF15-06090000	63V-45943-10-00	402
PAF15-06100000L	66M-45300-11-4D	277-291
PAF15-06100000S	66M-45300-02-4D	277-291
PAF15-07000000	66M-W009B-15-1S	185
PAF15-07000001	99510-10114	180-183-185
PAF15-07000001	91810-03014	181
PAF15-07000013	93604-12M07	183
PAF15-07000016	661-41262-01	100
PAF15-07000016	661-41262-02	100
PAF15-07000024	66M-46297-00	185
PAF15-07000028	90105-08M78	180-185
PAF15-07000030	97013-06035	197
PAF15-07000031	66M-12411-00	137
PAF15-07000031	66M-12411-01	137-179-180- 183
PAF15-07000031	6G8-12411-02	191
PAF15-07000031	6G8-12411-03	66-67-68-69- 137-195-197- 201-203-205- 207
PAF15-07000100	66M-11181-10	185-215-218
PAF15-07000200	66M-85580-00	107
PAF15-07000300	66M-85520-00	106
PAF15-07000400	66M-85533-00	104
PAF15-07000500	66M-85540-10	118
PAF15-07000600	66M-85570-00	104
PAF15-07010000	66M-15100-02-1S	183
PAF15-07010003	6C5-12858-00	187
PAF15-07010003	90401-20M00	183-191-197
PAF15-07010004	90344-51003	203-205
PAF15-07010006	6E5-24377-00	181-183
PAF15-07010007	90445-10M46	183
PAF15-07010008	66M-11325-00	183
PAF15-07010009	66M-11328-00	65-66-67-68-69- 183-191-197- 203-205-207
PAF15-07010011	66M-11327-00-94	168-183-191- 197-203-205- 207
PAF15-07010012	66M-12535-00	183-191-197- 203-205-207
PAF15-07010014	66M-11357-00	183
PAF15-07010015	90465-08M83	195
PAF15-07010018	66M-41114-01	65-140-183
PAF15-07010019	66M-41113-20-1S	183
PAF15-07010021	6H3-12413-00-1S	197-207-241
PAF15-07010021	6H3-12413-00-9M	191
PAF15-07010021	6H3-12413-001S	183
PAF15-07010022	62Y-12414-00	66-67-68-69- 138-183-191- 195-197-201
PAF15-07010023	5GH-13440-00	183
PAF15-07010024	66M-11416-00	183
PAF15-07010026	6E5-11325-00	183
PAF15-07010027	90480-12072	185-209-211
PAF15-07010103	62Y-82504-10	103
PAF15-07010103	65W-82504-00	103
PAF15-07010200	66M-11168-001S	183
PAF15-07020001	66M-11631-00-96	183-219
PAF15-07020005	93450-15023	183-219
PAF15-07020006	634-11633-00	183-219
PAF15-07020100	66M-11650-00	183
PAF15-07030000	66M-11411-00	183-219
PAF15-07030003	66M-11536-10	185
PAF15-07030004	66M-11557-00	185
PAF15-07030005	90170-28M37	185
PAF15-07030006	93102-25014	189
PAF15-07030006	93102-35M51	183
PAF15-07030007	93102-25M52	183
PAF15-07040000	66M-11111-01-1S	185
PAF15-07040001	66M-12111-00	185
PAF15-07040002	66M-12121-00	185
PAF15-07040004	66M-12116-00	185
PAF15-07040005	66M-12113-00	185
PAF15-07040006	30X-12117-00	189-193-195- 199-201-203- 207
PAF15-07040007	30X-12118-00	185-189-193- 195-199-201- 203-207
PAF15-07040008	93102-18M21	180-185
PAF15-07040009	90387-13001	185
PAF15-07040011	90387-13002	185
PAF15-07040012	90387-13M56	180-185
PAF15-07040013	90501-12M41	185
PAF15-07040014	90501-12M40	180-185
PAF15-07040015	66M-12146-00	185-189
PAF15-07040016	66M-13329-10	185
PAF15-07040017	90201-13201	180-185
PAF15-07040018	66M-11537-00-94	185
PAF15-07040200	66M-12170-00	185
PAF15-07040301	66M-12151-10	185
PAF15-07040300	62Y-12159-00	185-193-199
PAF15-07040303	64J-12159-00	189
PAF15-07040304	62Y-12158-00	185-189-193- 195-199-201- 203-205-207

REF	R.O. / OEM	
PAF15-07040500	66M-13300-10	185
PAF15-07050001	66M-11191-00-1S	185
PAF15-07050002	66M-11356-00	185
PAF15-07050003	90480-10M16	185
PAF15-07050004	69M-E5363-00	171-180 181-185-187- 191-195-197- 201-203-205- 207-209-211- 213-214
PAF15-07050004	6G8-15363-00	
PAF15-07050006	30X-12117-00	185
PAF15-07060001	6J8-81960-00	117
PAF15-07070000	66M-85550-00	109
PAF15-07070100W	66M-85550-10	109
PAF15-07080000	61N-24560-00	80
PAF15-07080002	61N-24521-00	80
PAF15-07090000	66M-14301-00	91
PAF15-07090000W	66M-14301-00	91
PAF15-07130001	63V-15716-00	113
PAF15-07130107	63V-15713-00	112
PAF15-07130201	63V-15714-00	113
PAF15-07130202	63V-15741-00	112
PAF15-07130203	63V-15767-00	112
PAF15-07130204	63V-15784-00	112
PAF15-07140000	66M-24410-11	85
PAF15-09000000	6G1-24306-55	74
PAF15-09000000	6Y1-24306-55-00	74
PAF15-10000002	6YJ-24167-00	76
PAF15-10000003	6Y1-24268-00	76
PAF15-10010000	6YJ-24610-00	75
PAF15-10010000	6YJ-24610-01	75
PAF15-10020000	6YJ-24260-00	76
PAF15-10020000	6YJ-24260-10	76
PAF15-10030001	66M-12138-60	185
PAF15-11000002W	703-48293-10	129
PAF15-11020000W	63V-61350-00	130
PAF15-13000000W	60J-24260-10	126
PAF15-13000100W	688-82586-21	128
PAF15-13000200W	703-82510-12	113
PAF15-13000500W	703-48261-01	127
PAF15-13010010W	703-48245-00	130
PAF15-13020007W	703-48152-00	129
PAF166-010003	51Y-12119-00	179-193
PAF2.6-00000003	69M-45113-A0	173-217-218
PAF2.6-00000004	69M-24575-00	76
PAF2.6-02000003L	69M-44361-10	283
PAF2.6-02000003S	69M-44361-00	283
PAF2.6-03000001	69M-G5311-00-4D	283
PAF2.6-03000002	6L5-45317-09	283
PAF2.6-03000003	6L5-45316-09	283
PAF2.6-03000004	93103-09M41	283
PAF2.6-03000007	69M-G5315-A0	283
PAF2.6-03000009	69M-G5321-00-94	283
PAF2.6-03000010	93210-05001	283
PAF2.6-03000010	69M-G4323-00	148-154-283
PAF2.6-03000011L	69M-G5511-10	283
PAF2.6-03000011S	69M-G5511-00	283
PAF2.6-03000012	93440-08819	28



REF	R.O. / OEM	
PAF2.6-04030000	69M-11400-00	173-219
PAF2.6-04040001	69M-E2155-00	173
PAF2.6-04040100	69M-E1111-00-1S	173
PAF2.6-04050001	69M-E5111-00-1S	171
PAF2.6-04050100	69M-E3102-00	171
PAF2.6-04060000	69M-E5396-00-5B	171
PAF2.6-04060001	69M-E5396-00	171
PAF2.6-04060002	93210-09004	171
PAF20-02000005	6AH-44368-00	293
PAF20-02000007	6AH-44365-00	293
PAF20-02000101L	6AH-44361-11	293
PAF20-02000101S	6AH-44361-01	293
PAF20-04000000L	6AH-45300-10-4D	277
PAF20-04000000L	6AH-45300-10-8D	277-292
PAF20-04000000S	6AH-45300-00-4D	277
PAF20-04000000S	6AH-45300-00-8D	277-292
PAF20-04000001	69G-45315-A0	292
PAF20-04010001	69G-45331-01-CA	292
PAF20-04020000L	6AH-44150-10	292
PAF20-04020000S	6AH-44150-00	292
PAF20-04030000L	6AH-45510-10	293
PAF20-04030000S	6AH-45510-00	293
PAF20-04040001	6AH-44311-00	147-293
PAF20-05000000	6AH-W009B-02-1S	189
PAF20-05000002	90105-090006	187
PAF20-05000003	6AH-46241-00	189-267
PAF20-05000016	6AH-12481-00	187
PAF20-05000027	6AH-11536-00	189
PAF20-05000028	6AH-11557-00	189
PAF20-05000029	90170-30003	189
PAF20-05000034	90480-10627	189
PAF20-05000036	90480-06M19	189
PAF20-05000100	6AH-85580-00	107
PAF20-05000200	6AH-85510-00	121
PAF20-05000300	6AH-85540-00	118
PAF20-05000500	6AH-85550-00	109
PAF20-05000500W	6AH-85550-10	109
PAF20-05000600	6AH-41113-01-1S	187
PAF20-05000602	6AH-41114-00	187
PAF20-05000700	6AH-12413-00-1S	187
PAF20-05000702	6AH-12414-00	65-187
PAF20-05000900W	6AH-81800-00	111
PAF20-05000900W	6AH-81800-01	111
PAF20-05010000	6AH-15100-00	187
PAF20-05010003	6AH-11416-00	189
PAF20-05010007	97013-06040	187
PAF20-05020001	6AH-11631-00	189-219
PAF20-05020002	93450-17129	189-219
PAF20-05020003	137-11633-10	189-219
PAF20-05020004	6AH-11411-00	189-219
PAF20-05020100	6AH-11603-00	189-219
PAF20-05020200	6AH-11650-10	189
PAF20-05030001	6AH-12111-00	189
PAF20-05030002	6AH-12121-10	189
PAF20-05030003	62Y-12116-00	189
PAF20-05030004	3YF-12113-00	189
PAF20-05030005	93102-22010	189
PAF20-05030006	90387-13006	189
PAF20-05030007	90501-120A5	189
PAF20-05030008	6AH-12279-00	189
PAF20-05030009	6G8-11197-01	203-205
PAF20-05030010	6G8-11197-A0	187
PAF20-05030011	6AH-13329-10	189
PAF20-05030012	90201-15423	189
PAF20-05030013	6AH-11537-00	189
PAF20-05030100	90201-08784	189
PAF20-05030100	6AH-11111-10-1S	187
PAF20-05030200	6AH-12170-00	189
PAF20-05030301	6AH-12151-00	189
PAF20-05030400	6AH-13300-00	189
PAF20-05040000	6AH-11191-001S	187
PAF20-05040002	6AH-11356-00	187
PAF20-05040003	6AH-11168-00	187
PAF20-05040004	6AH-11169-00	187
PAF20-05040005	62Y-14485-00	195
PAF20-05040005	6AH-11372-00	187
PAF20-05050000	6AH-24410-00	85
PAF20-05000702	6AH-12414-00	138
PAF20-07000100W	63AH-61350-00	130
PAF25-00000011	90105-10M12	295
PAF25-00000013	65W-11351-00	191
PAF25-00000013	65W-11351-10	21821-7
PAF25-00000014	93608-12063	235-239-241-243
PAF25-00000014	99530-08012	191-197-201-203-205-207
PAF25-01000001	90386-52M02	133
PAF25-01000004	90386-44M03	133
PAF25-01010002	90386-22M15	133
PAF25-02000004L	65W-44361-10	297
PAF25-02000004S	65W-44361-00	297
PAF25-02000005	90430-12072	297
PAF25-02000019	90202-12060	297-301-305-309-367-371
PAF25-02010005	62Y-11325-00	191
PAF25-02010007	67C-15312-00	271
PAF25-03000007	90387-06M69	133
PAF25-03000008	90445-09068	191-197-207
PAF25-03000009	90445-09095	191-197-207
PAF25-03000009	90445-09104	195
PAF25-03000011	90445-09105	191
PAF25-03000011	90445-09251	195
PAF25-04000001	61N-45311-02-4D	295
PAF25-04000002	61N-45536-00	297-355
PAF25-04000003-2	61N-45587-00-10	297

REF	R.O. / OEM	
PAF25-04000003-3	61N-45587-00-11	297
PAF25-04000003-4	61N-45587-00-12	297
PAF25-04000003-5	61N-45587-00-13	297
PAF25-04000003-6	61N-45587-00-14	297
PAF25-04000003-7	61N-45587-00-15	297
PAF25-04000004-3	6L2-45567-12	295
PAF25-04000004-5	6L2-45567-14	295
PAF25-04000005	61N-45551-00	295
PAF25-04000007	93604-08062	214-223-239-301-305-309-313-349-357-363-367
PAF25-04000007	93604-10M03	195-203-205-297-321-355-371
PAF25-04000008	65W-45331-00-5B	297
PAF25-04000009	61N-45315-00	297-355
PAF25-04000012	65W-44176-00	297
PAF25-04000013	61N-45127-00	297-355
PAF25-04000015	90280-03024	155-297
PAF25-04000016	65W-44328-00	297
PAF25-04000017	61N-44362-10	297-355
PAF25-04000017S	61N-44362-00	297-355
PAF25-04000021	61N-45214-00	295
PAF25-04000022	6L2-45214-00	295
PAF25-04000023	6L2-45215-00	295
PAF25-04010000L	61N-45510-10	297
PAF25-04010000S	61N-45510-00	297
PAF25-04030000L	65W-44150-10	297
PAF25-04030000S	65W-44150-00	297
PAF25-04050000	61N-44311-01	297
PAF25-04050001	61N-44311-01	148-154-155-297-355
PAF25-04050003	93210-45161	66-154-155-297-355
PAF25-04050004	6L2-44367-00	293-297-355
PAF25-04060000	648-45633-11	295
PAF25-04060002	90501-10065	295-355-357
PAF25-04060003	664-45631-02	295
PAF25-04060007	90201-20417	295
PAF25-04070000	61N-45361-01-8D	295-388-389
PAF25-04070001	61N-45361-01-4D	295-355
PAF25-04070004	61N-45571-00	295
PAF25-04070005-1	6L2-45577-00-10	295-355
PAF25-04070005-3	6L2-45577-00-12	295
PAF25-04080000	664-45947-01-EL	295
PAF25-04090000L	65W-45300-01-4D	278
PAF25-04090000L	65W-45300-10-4D	295
PAF25-04090000S	65W-45300-00-4D	295
PAF25-04090000S	65W-45300-01-4D	278
PAF25-05000002	90119-09M00	191-197-207
PAF25-05000003	65W-11356-00	191
PAF25-05000004	65W-11191-00-94	191
PAF25-05000005	65W-15121-00	191
PAF25-05000007	65W-15121-00	191
PAF25-05000016	90464-07M05	241
PAF25-05000021	65W-11536-10	193-199
PAF25-05000022	65W-11476-00	193-199
PAF25-05000024	90280-04M06	199
PAF25-05000026	90170-20137	195
PAF25-05000026	90170-35M47	193
PAF25-05000100	5GH-13440-00	191
PAF25-05010000	65W-15100-00-94	191
PAF25-05010103	65W-11168-00	191
PAF25-05010106	65W-11119-00	197
PAF25-05010106	66W-11119-00	191
PAF25-05010107	65W-13286-00	191
PAF25-05010108	65W-11169-00	191
PAF25-05010111	65W-41114-00	141-191
PAF25-05010112	65W-41113-01-94	191
PAF25-05010113	62Y-11372-01	191
PAF25-05010113	62Y-12481-10	203-205
PAF25-05010201	65W-85790-00	103
PAF25-05010302-1	62Y-11416-00	193-199
PAF25-05010302-2	62Y-11416-10	193-199
PAF25-05020001	65W-11411-01	193-219
PAF25-05020002	93102-35M47	193-199
PAF25-05020003	93102-43M42	193-199-199-201-203-207
PAF25-05020100	65W-11631-00-96	193-199-219
PAF25-05020101	65W-11631-00-96	193-199
PAF25-05020105	62Y-11633-00	193-195-199-201-203-205-207-219
PAF25-05020106	93450-17129	193-195-199-201-203-205-207-219-231
PAF25-05020200	62Y-11650-10	199
PAF25-05020200	67C-11650-00	193
PAF25-05020200	6C5-11650-00	195-203-207
PAF25-05020200	6C5-11650-10	201-205
PAF25-05020203-1	62Y-11656-00	193-199
PAF25-05020203-2	62Y-11656-00	193
PAF25-05020203-2	62Y-11656-10	199
PAF25-05020204	62Y-11654-00	193-199
PAF25-05020204	6AH-11654-00	189
PAF25-05020204	6C5-11654-00	195-201-203-205-207
PAF25-05020301	65W-11642-11	193
PAF25-05020310	65W-11665-00	193
PAF25-05040000	65W-11181-30	191-215-218
PAF25-05050001	67C-12111-00	193-199
PAF25-05050002	62Y-12121-00	193-199-207
PAF25-05050003	62Y-12116-00	193-195-199-201-203-207

REF	R.O. / OEM	
PAF25-05050005	51Y-12114-00	193-195-199-201-203-207
PAF25-05050006	90109-06M65	191-195-197-201-203-205-207
PAF25-05050007	90430-06014	191-195-197-201-203-205-207
PAF25-05050008	65W-12146-00	193
PAF25-05050009	62Y-12238-00	193-207
PAF25-05050011	62Y-12216-00	193-199-207
PAF25-05050012	62Y-12231-00	193-207
PAF25-05050013	93210-12MG9	193-199-207
PAF25-05050014	93210-14515	193-199-207
PAF25-05050015	93210-33MH2	193-199-207
PAF25-05050016	93605-14143	193-199-207
PAF25-05050017	65W-11537-01	193
PAF25-05050018	90201-10144	201
PAF25-05050018	90201-10M06	193-199-207
PAF25-05050019	90109-08M63	193-199-207
PAF25-05050021	93102-37004	189
PAF25-05050021	93102-37M40	193-195-199-201-203-205-207
PAF25-05050100	65W-11111-02-94	191
PAF25-05050200	65W-12171-10	193
PAF25-05050300	65W-12151-00	193
PAF25-05050301	65W-12151-00	193-199
PAF25-05050400	65W-13300-00	193
PAF25-05070000	65W-14901-12	91
PAF25-05070019	6H4-14548-00	99
PAF25-05080004	65W-14457-10	268
PAF25-05110000	65W-85580-00	107
PAF25-05120000	65W-85570-01	104
PAF25-05130000	62Y-24410-04	85
PAF25-05130005	62Y-24471-00	87
PAF25-05140000	65W-85510-10	121
PAF25-05150000	65W-85550-01	109
PAF25-07000007W	703-48345-01	127
PAF25-07000300W	65W-61350-00	130
PAF4-00000001	90387-06806	285-287
PAF4-00000001	90387-06M14	345
PAF4-00000006	67D-45113-A0	175-217-218
PAF4-01090100	6EG-G2138-00	131
PAF4-01090100	6G1-42138-00	131
PAF4-01090100	6G1-42138-01	131
PAF4-01090300	6EG-G2177-10	134
PAF4-01090300	6EE-G2177-00	134
PAF4-01090401	682-82556-00	120
PAF4-02040001	68D-G4360-10	285
PAF4-02040001S	68D-G4360-00	285
PAF4-02040002	68D-G4365-	

REF	R.O. / OEM	
PAF4-03060000	6E0-44352-00	64-285
PAF4-03070000	6E0-45943-01	287
PAF4-03070000	6E0-45943-01-EL	285-402
PAF4-03080000	6L5-45616-00	283-285-287-405
PAF4-0310000L	68D-65300-11-4D	277
PAF4-0310000L	68D-65300-10-4D	285
PAF4-0310000S	68D-65300-03-4D	277
PAF4-0310000S	68D-65300-00-4D	285
PAF4-04000000	680-WE090-11-15	175
PAF4-04000001	90105-08M76	171
PAF4-04000001	97095-08020	331-335-337-341
PAF4-04000001	97095-08020-00	177
PAF4-04000002	68D-11351-A0	177-270
PAF4-04000003	99510-10114	175-177-179
PAF4-04000004	90201-266P2	175
PAF4-04000006	90201-08818	177
PAF4-04000006	90201-08818-00	171
PAF4-04000006	90430-08143	197-209-211
PAF4-04000006	90430-08800	179
PAF4-04000006	90430-08800-00	175
PAF4-04000006	90201-08818	64-66
PAF4-04000007	68D-E5362-00	177
PAF4-04000008	93210-24M79	177-180-185-201-203-205
PAF4-04000009	68D-E1169-A0	177
PAF4-04000010	68D-E1168-00	177
PAF4-04000010	68D-E5362-00	179
PAF4-04000011	68D-E2414-A0	64-138-173-175-179
PAF4-04000012	90445-09807	175
PAF4-04000014	67D-11181-A0	175-215-218
PAF4-04000015	67D-12154-00	175
PAF4-04000017	68D-E1193-A0	175
PAF4-04000018	67D-11191-00	175
PAF4-04000019	90280-04M06	193-207
PAF4-04000030	90467-08004	75-243
PAF4-04000030	90467-09M09	191-225
PAF4-04000030	90467-09M09	64-65-67
PAF4-04000033	90105-08046-00	175
PAF4-04000034	90105-08M36	173-179-180
PAF4-04000034	90105-08M36-00	175
PAF4-04000036	6EE-E5362-00	177
PAF4-04000038	67D-85640-00	106
PAF4-04010003	68D-E5346-00	177
PAF4-04010004	93102-25090	177
PAF4-04010100	68D-E1311-02-15	177
PAF4-04010102	650-24378-00	173-175-177-179-180-235-237-241
PAF4-04010102	6E9-24378-00	187
PAF4-04020001	68D-E1631-00-96	175
PAF4-04020005	68D-E1633-00	175-219
PAF4-04020006	93450-14088	175-219
PAF4-04020100	67D-11650-00	175
PAF4-04020103	67D-11654-00	175
PAF4-04020200	68D-E1631-00-96	175-219
PAF4-04030000	67D-11400-00	175-219
PAF4-04040000	68D-E2170-00	175
PAF4-04050100	68D-E3102-00	177
PAF4-04050200	68D-E5111-00-1S	177
PAF4-04060000	6EE-E5396-00-CA	177
PAF4-04060001	68D-E5396-00-5B	177-179
PAF4-04060002	93210-35537	171-177
PAF4-04060004	93102-10004	177-179
PAF4-04070000	68D-E2413-00-1S	179
PAF4-04070001	67D-12413-00-1S	175
PAF4-04070003	68D-E1325-00	64-65-66-67-68-69-70-71-173-175-179
PAF4-04070100	68D-E2413-001S	175
PAF4-04080005	67D-12111-00	175
PAF4-04080006	67D-12121-00	175-180
PAF4-04080007	68T-12116-00	175-179-180
PAF4-04080008	68D-E2113-00	173-175
PAF4-04080009	68D-E2155-00	175
PAF4-04080101	68D-E1111-10-1S	175
PAF4-04090000	67D-24410-03	85
PAF4-04120005	6L5-24251-00	64-80-81-82
PAF4-04120100	67D-24610-00	75
PAF4-04120100	67D-24610-02	75
PAF4-04120100	67D-24610-03	75
PAF4-04120100	67D-24610-04	75
PAF4-04120100	68D-24610-10	75
PAF4-04120103	624-24634-00	75
PAF4-04130100	6G1-15755-00	113
PAF4-04130100	6G1-15779-00	113
PAF4-04140000	67D-14301-03	91
PAF4-05000010	90467-13M13	75
PAF4-05000300	646-24251-01	80
PAF4-05000300	646-24251-02	64-80-81
PAF4-04000000L	66T-45300-10-4D	279
PAF4-04000000L	66T-45311-13-8D	279
PAF4-05000053	90445-10M40	209
PAF4-05040003	62Y-12279-00	207
PAF4-05040006	67C-11537-01	199
PAF4-05070002	62Y-14485-00	197-201-203-207
PAF4-07010000E	907-94469-05	79
PAF4-13000000E	703-48272-12	126
PAF6-00000001	6BX-45113-00	151-179-217
PAF6-03000002	6BX-44322-00	154-287
PAF6-04000001	6BX-11351-00	179
PAF6-04000002	6BX-11181-00	179-215
PAF6-04000003	6BX-12154-00	179

REF	R.O. / OEM	
PAF6-04000004	6BX-E1191-00-5B	179
PAF6-04000005	6BX-11356-00	179
PAF6-04000009	6G0-82519-00	179
PAF6-04000020	6BX-F4323-00	179
PAF6-04010004	6BX-E1168-00	179
PAF6-04030000	6BX-E2170-00	179
PAF6-04050001	6BX-12111-00	179
PAF6-04050002	6AU-12121-00	179
PAF6-04050003	60R-12113-00	179
PAF6-04050004	6BX-E2155-00	179
PAF6-04050100	6BX-E1111-00-1S	179
PAF6-02000007	6C5-44361-00	313
PAF6-04000000	69W-45300-00-4D	278
PAF6-04000000	69W-45300-00-8D	278
PAF6-04000000	69W-45300-01-8D	278
PAF6-04000000	69W-45300-04-8D	311
PAF6-04000001	69W-45301-00-8D	311
PAF6-04000002	69W-45551-00	311
PAF6-04000003	62Y-44151-00	303-307-311
PAF6-04000008	63D-45344-00	313
PAF6-04000101	63D-45321-00	305-309-313
PAF6-04000500	62Y-45571-00	311
PAF6-04000600	69W-45560-00	311
PAF6-04010000	69W-45501-00	313
PAF6-04020001	63D-45611-00	303-307-311
PAF6-04020002	90501-18001	303-307-311
PAF6-04020003	62Y-45631-00	307-311
PAF6-04020005	63D-45635-00	303-307-311
PAF6-04030000	63D-45361-02-8D	307-311
PAF6-06000000	6C5-43800-11	124
PAF6-06000000	6C5-43800-12	124
PAF8-05000022	90119-06MA3	187
PAF8-05030006	7NJ-12117-00	173-175
PAF8-05030007	7NJ-12118-00	173-175-179
PAGB/T1099-3X5X13	90280-03017	201
PAGB/T1099-3X5X13	90280-03M01	180-185-189-195-203-205
PAGB/T276-6004C2	93306-004U0	345
PAGB/T276-6004C2	93306-004YH	289
PAGB/T276-6004C2	93306-205YD	177
PAGB/T276-6006/P6	93306-00612	295
PAGB/T276-62/22/P6	93306-272Y2	171
PAGB/T290F-2020	93315-220V7	297
PAGB/T345.2-D32.5XD1	93210-35537	179
PAGB/T3452.1-13X2	93210-13M63	64-65-68-69-70-71-180-187-195-201-203-205
PAGB/T3452.1-25.8X2	93210-22164	355
PAGB/T3452.1-25.8X2	93210-26130	297-355
PAGB/T3452.1-32.5X1.8	93210-32738	65-66-67-68-69-70-71-180-185
PAGB/T5287.6	90201-06M94	180-185
PAGB/T5782-2000S	90119-06M40	285
PAGB/T5782-M6X125	95895-06035	295
PAGB/T5782-M6X125	97013-06035	193-285
PAGB/T5782-M6X25	97095-06025	209-213-231
PAGB/T5782-M6X35	90119-06MA5	191-203-205-233-241
PAGB/T5782-M6X45	90105-06M25	175
PAGB/T5782-M6X45	947395-06040	349
PAGB/T5782-M8X35	65W-08M87	191
PAGB/T5782-M8X80	90119-08M01	191
PAGB/T5783-M5X10	97013-05010	179
PAGB/T5783-M5X12	68D-E5362-00	183
PAGB/T5783-M5X12	90119-06M48	295
PAGB/T5783-M5X12	90201-08818	183
PAGB/T5783-M5X12	90465-08M99	171
PAGB/T5783-M5X12	92995-06600	185-237
PAGB/T5783-M5X12	93102-25090	183
PAGB/T5783-M5X12	93306-205YD	183
PAGB/T5783-M5X12	95895-06016	287-289
PAGB/T5783-M5X12	95895-06016-00	285
PAGB/T5783-M5X12	95895-06020	283
PAGB/T5783-M5X12	97013-06016	185-223-229
PAGB/T5783-M5X12	97013-06045	171
PAGB/T5783-M5X12	97095-05012	191
PAGB/T5783-M5X12	97095-0512	183
PAGB/T5783-M5X12	97095-06035	185
PAGB/T5783-M5X12	97575-08550-00	183
PAGB/T5783-M5X16	97095-05016	343
PAGB/T5783-M6X10	97095-06010	197-349-363
PAGB/T5783-M6X12	95817-06012	171
PAGB/T5783-M6X12	95817-06012-00	177
PAGB/T5783-M6X12	97013-06012	189
PAGB/T5783-M6X14	90119-06M80-00	177
PAGB/T5783-M6X14	95895-06012	287
PAGB/T5783-M6X16	90105-06039	173
PAGB/T5783-M6X16	90105-06M14	175
PAGB/T5783-M6X16	92995-06600	371
PAGB/T5783-M6X16	97090-06014	343
PAGB/T5783-M6X16	97095-06016	221-223-225-227-231-235-239-321-339
PAGB/T5783-M6X20	65W-12228-00	191
PAGB/T5783-M6X20	90119-06MA2	179-227
PAGB/T5783-M6X20	90119-06MA3	191
PAGB/T5783-M6X20	97095-06020	171-173-179-180-191-195-197-201-203-205-207-209-213-233-237-241-291-347-351
PAGB/T5783-M6X20	97095-06020-00	175
PAGB/T5783-M6X20	97395-06020	349

REF	R.O. / OEM	
PAGB/T5783-M6X20	97575-06520	293
PAGB/T5783-M6X20	97595-06520	185-187
PAGB/T5783-M6X20	65W-12228-00	191
PAGB/T5783-M6X25	90119-06MA3	187-191-235
PAGB/T5783-M6X25	90119-06MA5	191
PAGB/T5783-M6X25	90119-08MA5	235
PAGB/T5783-M6X25	97513-06525	185
PAGB/T5783-M6X30	90119-06M04	227
PAGB/T5783-M6X30	90119-06MA4	235
PAGB/T5783-M6X30	90119-06MA5	195
PAGB/T5783-M6X30	95895-06035	293
PAGB/T5783-M6X30	970-95-06030	231
PAGB/T5783-M6X30	97095-06030	180-211-213-343-346
PAGB/T5783-M6X35	90105-06035	189
PAGB/T5783-M6X35	90119-06MA5	243
PAGB/T5783-M6X35	90119-06MA5	191
PAGB/T5783-M6X35	95895-06012	343-347
PAGB/T5783-M8X14	97095-08014	171-179
PAGB/T5783-M8X14	97095-08014-00	175
PAGB/T5783-M8X20	97095-08020	179
PAGB/T5783-M8X20	97095-08020-00	177
PAGB/T5783-M8X25	90105-081A7	189
PAGB/T5783-M8X25	97075-08025	209
PAGB/T5783-M8X25	97080-08025	289-291-292-351
PAGB/T5783-M8X25	97095-08025	299-303-307-311-325-329-333-339
PAGB/T5783-M8X30	97575-08530	293
PAGB/T5783-M8X35	90101-08001	235
PAGB/T5783-M8X35	97075-08035	289
PAGB/T5783-M8X35	97095-08035	303-307-311
PAGB/T5787-1986	97575-08550-00	177
PAGB/T6182-M5	90185-05002	289-293-315-319-323-327-331-335-337-341-350
PAGB/T818-M4X10	97607-04210	187
PAGB/T818-M4X10	98507-04010	195-197-201-203-205-207
PAGB/T818-M4X6	98503-04066-00	177
PAGB/T818-M5X12	97095-05012	197-203-205-207
PAGB/T818-M5X16	98780-05016	211
PAGB/T818-M5X25	97880-05025	173-179-203-205
PAGB/T818-M5X25	97880-05025-00	175
PAGB/T818-M5X25	98980-05025	187
PAGB/T818-M6X16	98580-06016	365
PAGB/T820-M4X12	98780-04015	213-239
PAGB/T820-M4X12	98780-04016	187-209-237
PAGB/T820-M5X20	90152-05011	293
PAGB/T820-M5X25	90152-05M03	289
PAGB/T820-M5X25	90152-05M04	350
PAGB/T820-M5X30	6E0-W0078-00	345
PAGB/T820-M5X30	6E0-W0078-01	345
PAGB/T820-M5X30	6E0-W0078-02	345
PAGB/T820-M5X30	90142-05M06	299
PAGB/T820-M5X30	90151-05M05	295
PAGB/T820-M5X30	90152-05010	303-311
PAGB/T820-M5X30	90152-05M06	307
PAGB/T820-M5X30	90152-05M06	365
PAGB/T845-ST4.2X16	97780-40112	349
PAGB/T845-ST4.8X9	97780-50510	349



REF	R.O. / OEM		REF	R.O. / OEM		REF	R.O. / OEM	
PAGB/T97.1-8	92990-08600	367	PAT40-04060005-5	63D-45577-40	299-303-307-311	PH130-0076	6C9-81800-00	112
PAGB/T97.1-8	92990-14200	295				PH130-0076	6D0-81800-00	112
PAGB/T97.1-8	92995-05600	183-203-205	PAT40-04060005-6	63D-45577-50	299-303-307-311	PH130-0084	66M-81800-00	110
PAGB/T97.1-8	92995-06600	185-227-229-233-241				PH130-0084	66M-81800-01	110
		179-209-214-325-329-333-335-337-341-343-363-369-377	PAT40-04060005-7	63D-45577-60	299-303-307-311	PH130-0084	66M-81800-02	110
PAGB/T97.1-8	92995-08600	295-299-303-307-311-315-319-331				PH200-T029	6H1-43880-02	122
PAGB/T97.1-8	92995-10600	307-311-315-319-331	PAT40-04070000	69W-45941-00-EL	402	PH200-T030	6G5-43880-00	123
PAGB/T97.1-8	93102-20108	183	PAT40-05000100	6AH-82560-00	103	PH200-T030	6G5-43880-01	123
PAGB/T97.1-8	97595-06520	183-191-193-283	PAT40-10000000	65W-43800-00-4D	124	PH200-T030	6G5-43880-02	123
PAGBT3452.1-97.5X1.8	65W-15663-00	191	PAT40-10000000	65W-43800-01-4D	124	PH200-T035	62X-43880-00	122
PAHI-CAP32004JRKYOYO	93332-000W5	297	PAT40-10000000	65W-43800-02-4D	124	PH200-T035	62X-43880-01	122
PAHT-2.5X50	90465-11M10	293	PAT40-10000000	65W-43800-03-4D	124	PH200-T035	62X-43880-09	122
		180-191-197-207-209-213-301-305-309-313-317-321-325	PAT40-10000000	65W-43800-20-4D	124	PH200-T036	62Y-43880-01	122
PAHT-2.5X60	90467-06016	221-225-231-237-239-241	PAT40-10000000	65W-43800-21-4D	124	PH200-T036	62Y-43880-02	122
PAHT2.5X50	90465-11M10	187	PAT40-10000000	65W-43800-22-8D	124	PH200-T036	69W-43880-00	122
PAJASOF404-19-033	93210-33M49	335-339	PAT40-10000000	65W-43800-23-8D	124	PH200-T036	69W-43880-01	122
PAJASOF404-19-033	93210-33M85	64-154-283	PAT40-10000000	65W-43880-00	123	PH200-T036	CS3-43880-00	122
PAJASOF404-31-045	93210-44398	351	PAT40-10020500	65W-43880-01	123	PH200-T037	688-43880-11	123
PAJASOF40424-050	93210-48001	313	PAT40-10020500	65W-43880-01	123	PH200-T037	6E5-43880-00	123
		64-65-69-70-171-181-187-191-195-197-207-209-211-213-214	PAT85-00000012	90105-10M00	323-327-331-335-337-375-379	PH200-T037	6E5-43880-01	123
PAJASOF40431-025	93210-24M79	213-214				PH200-T037	6E5-43880-02	123
PAJB/T9740.1-M6	93700-06M03	133	PAT85-00000012	90105-16M67	315-319	PH200-T041	6H1-43880-00	122
PAJISB2401P48	93210-48214	283-285	PAT85-00000017	90386-18M35	133	PH200-T044	67F-43880-00	123
PAKOYOHI-CAP322/32	93332-00092	311	PAT85-01010203	90386-10M16	133	PH200-T045	6C5-43880-00	123
PANTN16003EY	93316-003Y0	283	PAT85-01020003	90386-30M78	133	PH200-T045	6C5-43880-01	123
PANTN6205C3	93306-205B2	179	PAT85-01200003	90386-30M77	133	PH200-T048	6H5-43880-00	122
		175-185-199-203-205-207-213	PAT85-040000003-B	688-45587-01	317-321	PH200-T048	6H5-43880-01	122
PAPS2700.04.03	51Y-12119-00	203-205-207-213	PAT85-040000004-B	688-45567-01	315-319	PH200-T048	6H5-43880-02	122
		213	PAT85-05000023	6C5-82105-01	112	PH200-T048	6H5-43880-09	122
PAT15-04010202	62A-14485-00	235	PAT85-05000023	6H0-82105-02	112	PH200-T050	61A-43880-00	124
PAT15-04010202	6H1-14485-00	171	PAT85-05000023	6H0-82105-J2	112	PH200-T050	61A-43880-01	124
PAT20-13000500W	703-48861-11	1276	PAT85-05030300	6AH-81960-00	116	PH200-T057	67H-43880-00	123
PAT36-04000023	90465-06M86	179	PAT85-08010000W	703-48205-10	126	PH200-T057	68W-43880-03	123
		301-305-309-313-317-321-367-371	PAT85-08010100	688-8258A-20	128	PH200-T057	6AE-43880-00	123
PAT40-02000002	663-44367-00	301-305-309-313	PH130-0005	6E5-81800-10	110	PH200-T057	6AE-43880-01	123
		313	PH130-0005	6E5-81800-11	110	PH200-T057	6AE-43880-03	123
PAT40-04000002	6H4-45536-00	309	PH130-0005	6E5-81800-12	110	PH200-T057	6AE-43880-04	123
PAT40-04000003-1	663-45587-01	367	PH130-0007	676-81800-10	111	PH200-T068	6D8-43880-00	123
PAT40-04000003-1	663-45587-01-10	367	PH130-0007	697-81800-10	111	PH200-T068	6D8-43880-09	123
PAT40-04000003-2	663-45587-01-12	367	PH130-0007	697-81800-11	111	PH200-T069	60V-43880-00	123
PAT40-04000003-2	663-45587-10	309	PH130-0007	697-81800-12	111	PH200-T069	69J-43880-00	123
PAT40-04000003-3	663-45587-01-15	367	PH130-0028	99999-03249	111	PH200-T069	69J-43880-01	123
PAT40-04000003-3	663-45587-20	309	PH130-0028	67C-81800-01	110	PH200-WH01	65W-81941-00	111-114
PAT40-04000003-4	663-45587-01-18	367	PH130-0028	67C-81800-02	110	PH375-0034	65W-81941-00	110
PAT40-04000003-4	663-45587-30	309	PH130-0029	67C-81800-03	110	PH375-0036	68N-81940-00	114
PAT40-04000003-5	663-45587-01-30	367	PH130-0029	65W-81800-00	111	PH375-0042	68V-8194A-00	114
PAT40-04000003-5	663-45587-40	309	PH130-0029	65W-81800-02	111	PH375-0042	6E5-81950-01	110-115
PAT40-04000003-6	663-45587-01-40	367	PH130-0029	65W-81800-03	111	PH375-0047	6E5-8195A-01	115
PAT40-04000003-6	663-45587-50	309	PH130-0034	66M-81800-01	111	PH375-0048	6E5-8195C-01	115
PAT40-04000003-7	663-45587-01-50	367	PH130-0034	66M-81800-02	111	POWERHEAD2.6	69M-WE0090-01-1S	173
PAT40-04000003-7	663-45587-60	309	PH130-0049	689-81800-10	110	POWERHEAD20-25		193
		299-303-307-311	PH130-0049	689-81800-11	110	PRE3300C05	YMM-21005-00-00	130
PAT40-04000004-1	663-45567-01	365	PH130-0049	689-81800-12	110	PRE3300C06	YMM-21006-C8-00	130
PAT40-04000004-1	663-45567-01-10	365	PH130-0049	689-81800-13	110	PRE3300C07	YMM-21007-C8-00	130
PAT40-04000004-2	663-45567-01-12	365	PH130-0050	6H3-81800-10	111	PRE3300C08	YMM-21008-C8-00	130
		299-303-307-311	PH130-0050	6H3-81800-11	111	PRE3300C09	YMM-21009-C8-00	130
PAT40-04000004-2	663-45567-10	365	PH130-0051	6H3-81800-01	110	PRE3300C10	YMM-21010-C8-00	130
PAT40-04000004-3	663-45567-01-15	365	PH130-0051	6H3-81800-02	110	PRE3300C11	YMM-21011-C8-00	130
		299-303-307-311	PH130-0051	6H3-81800-03	110	PRE3300C12	YMM-21012-C8-00	130
PAT40-04000004-3	663-45567-20	365	PH130-0051	6H3-81800-04	110	PRE3300C13	YMM-21013-C8-00	130
PAT40-04000004-5	663-45567-01-30	365	PH130-0051	68F-81800-00	111	PRE3300C14	YMM-21014-C8-00	130
		299-303-307-311	PH130-0051	68F-81800-01	111	PRE3300C15	YMM-21015-C8-00	130
PAT40-04000004-5	663-45567-40	365	PH130-0051	68F-81800-03	111	PRE3300C16	YMM-21016-C8-00	130
		299-303-307-311	PH130-0051	68F-81800-04	111	PRE3300C17	YMM-21017-C8-00	130
PAT40-04000007	66T-45321-00	301	PH130-0056	68F-81800-00	111	PRE3300C18	YMM-21018-C8-00	130
		301-305-309-313	PH130-0056	68F-81800-01	111	PRE3300C19	YMM-21019-C8-00	130
PAT40-04000008	90201-27M00	301-305-309-313	PH130-0056	68F-81800-03	111	PRE3300C20	YMM-21020-C8-00	130
		301-305-309-313	PH130-0056	68F-81800-04	111	PRE3300C21	YMM-21021-C8-00	130
PAT40-04000009	66T-45344-01	301-305-309-313	PH130-0056	6C5-81800-00	111	PRE3300C22	YMM-21022-C8-00	130
		301-305-309-313	PH130-0056	6CJ-81800-00	111	PRE3300C23	YMM-21023-C8-00	130
PAT40-04000014	63D-45375-00	299-303-307-311	PH130-0057	68V-81800-00	111	PRE3300C24	YMM-21024-C8-00	130
		299-303-307-311	PH130-0057	68V-81800-01	111	PRE3300C25	YMM-21025-C8-00	130
PAT40-04000022	63D-45214-00	299-303-307-311	PH130-0057	68V-81800-02	111	PRE3300C26	YMM-21026-C8-00	130
		299-303-307-311	PH130-0057	68V-81800-03	111	PRE3300C27	YMM-21027-C8-00	130
PAT40-04000023	63D-45215-00	299-303-307-311	PH130-0058	688-81800-10	111	PRE3300C28	YMM-21028-C8-00	130
		299-303-307-311	PH130-0058	688-81800-11	111	PRE3300C29	YMM-21029-C8-00	130
PAT40-04000027	93332-00079	367	PH130-0058	688-81800-12	111	PRE3300C30	YMM-21030-C8-00	130
PAT40-04000003-1	663-45587-01	301-305-313	PH130-0059	61A-81800-00	110			
PAT40-04000003-2	663-45587-10	301-305-313	PH130-0059	61A-81800-01	110	RAC120R-RAC-01	YMM-2W114-00	79
PAT40-04000003-3	663-45587-20	301-305-313	PH130-0061	61A-81800-02	110	RAC320R-RAC-01	YMM-2W227-01	78
PAT40-04000003-4	663-45587-30	301-305-313	PH130-0061	61A-81800-03	110	RAC320R-RAC-03		78
PAT40-04000003-5	663-45587-40	301-305-313	PH130-0061	682-81800-10	110	RAC490R-RAC-01	YMM-2W227-01	79
PAT40-04000003-6	663-45587-50	301-305-313	PH130-0061	682-81800-11	110	RACPF5510		77
PAT40-04000003-6	663-45587-60	301-305-313	PH130-0061	682-81800-12	110	RACRK22628		79
PAT40-04000003-7	663-45587-70	301-305-313	PH130-0061	682-81800-13	110	RACS3213	MAR-24563-00	78
PAT40-040000201	66T-44311-00	148-301-305	PH130-0061	6L2-81800-10	110	RACS3227	YMM-2E227-00	79
PAT40-04040001	66G-44341-00	313	PH130-0061	6L2-81800-11	110	RACS3227	YMM-2E227-01	79
PAT40-04050002	90501-15M01	361	PH130-0062	6L2-81800-12	110	RACS3240	YMM-2E114-00	79
PAT40-04050005	67C-45633-00	307-311	PH130-0062	6F5-81800-10	110	REC09168-12017	90430-10M11	

REF	R.O. / OEM	
REC25000		77
REC25010		77
REC25020		77
REC25030		77
REC25W40U3		84
REC2TU3	YMD-63021-04	84
REC2TU6	YMD-63021-01	84
REC35-802893Q		77
REC35-802893Q01		77
REC35-80365M	646-24251-01	80
REC35-80365M	646-24251-02	80-82-83
REC35-822626Q15	69J-13440-00	83
REC35-822626Q15	69J-13440-01	83-211-213
REC35-822626Q15	69J-13440-03	71-72-73-83
REC3FV-13440-00	3FV-13440-00	83
REC3FV-13440-00	3FV-13440-10	83
REC3FV-13440-00	3FV-13440-20	83
REC3FV-13440-00	3FV-13440-30	67-83
REC40135		80
REC40145	65W-24251-00	82
REC40145	65W-24251-10	80
REC40145		65-67-81
REC40155		80
REC40165	67F-24251-02	80-81-82
REC405-A20	6E5-45300-16-8D	375
REC405-A20	6E5-45300-17-8D	280
REC405-A25	6E5-45300-26-8D	375
REC405-A25	6E5-45300-27-8D	280
REC40970		121
REC40990		121
REC416-A20	64D-45300-01-8D	280
REC416-A20	64D-45300-02-8D	379
REC416-A25	64D-45300-21-8D	280
REC416-A25	64D-45300-22-8D	379
REC416-B20	64K-45300-02-NA	281
REC416-B20F	63P-45300-00-8D	278
REC416-B20F	63P-45300-02-8D	327
REC416-B25F	63P-45300-10-8D	278
REC416-B25F	63P-45300-12-8D	327
REC418-A25	64P-45300-10-8D	280
REC418-B25F	64P-45300-10-8D	278
REC418-B25F	64P-45300-12-8D	327
REC421-A20	66K-45300-12-NA	281
REC421-A25	60V-45300-20-8D	281
REC421-B25F	69J-45300-21-8D	279
REC421-B25F	69J-45300-22-8D	331
REC421-B30F	69J-45300-32-8D	279
REC422-B25F	6P2-45300-20-8D	278-339
REC422-B25F	6P2-45300-21-8D	278-339
REC422-B25F	6P2-45300-40-8D	278
REC422-B25F	6P2-45300-41-8D	278
REC422-B25F	6P245300208D	278
REC422-B25F	6P245300218D	278
REC422-B25F	6P245300408D	278
REC422-B25F	6P245300418D	278
REC428-A25	60W-45300-20-8D	281
REC428-B25F	69K-45300-21-8D	279
REC428-B30F	69K-45300-34-8D	279
REC429-B25F	6P3-45300-40-8D	278-339
REC429-B25F	6P3-45300-41-8D	278-339
REC429-B25F	6P3-45300-42-8D	278
REC429-B25F	6P345300408D	278
REC429-B25F	6P345300418D	278
REC429-B25F	6P345300428D	278
REC48630-92J00	61A-43811-00	125
REC48630-92J00	63P-43811-10	125
REC48630-92J00	63P-43811-20	125
REC48630-92J00	64E-43811-02	125
REC48630-92J00	64E-43821-05	125
REC48630-92J00	6AW-4380R-01	125
REC48630-92J00	6EK-4380R-00	125
REC48630-94900	61A-43821-00	125
REC48630-94900	61A-43821-01	125
REC48630-94900	61A-43821-09	125
REC48630-94900	67F-4380R-00	125
REC48630-94900	67F-4380R-01	125
REC48630-94900	67F-43811-00	125
REC48630-96J03	64E-43820-00	125
REC48630-96J03	64E-43820-08	125
REC48630-96J03	64E-43820-09	125
REC48630-96J03	64E-43820-09	125
REC48630-96J03	64E-43820-08	125
REC48630-96J03	64E-43820-09	125
REC48630-96J03	64E-43820-09	125
REC48630-96J03	64E-43821-08	125
REC48630-96J03	6AW-4380R-00	125
REC50M-14355-00	50M-14355-00	99
REC5GH-13440-00	5GH-13440-00	83-183-191-197-209
REC5GH-13440-00	5GH-13440-10	207
REC5GH-13440-00	5GH-13440-30	83
REC5GH-13440-00	5GH-13440-70	83
REC5GH-13440-00	5GH-13440-70	65-66-67-68-69-70-71-83
REC5GH-13440-60	5GH-13440-20	195-203
REC5GH-13440-60	5GH-13440-50	83-201-205
REC5GH-13440-60	5GH-13440-60	83-187
REC5GH-13440-60	5GH-13440-60	65-66-67-68-69-83
REC5W40U3		84
REC5W40U6		84
REC60E-81950-00	60E-81950-00	115
REC60H-12416-00	60H-12416-00	245-247
REC60H-12416-00	6G5-12416-00	209-211

REF	R.O. / OEM	
REC60V-11181-00	60V-11181-00	249-254
REC60V-12411-00	60V-12411-00	70-137
REC60V-13621-A0	60V-13621-A0	276
REC60V-13645-00	60V-13645-00	276
REC60V-13907-00	60V-13907-00	86
REC60V-24251-01	60V-24251-01	82
REC60V-44150-00	60V-44150-00	385
REC60V-45113-02	60V-45113-02	254
REC60V-45332-00-94	60V-45332-00-94	383
REC60V-45611-00	60V-45611-00	383
REC60V-81950-00	60V-81950-00	115
REC60V-81960-05	60V-81960-05	117
REC60V-81960-05	60V-81960-01	117
REC60V-81960-05	60V-81960-02	117
REC60V-81960-05	60V-81960-03	117
REC60V-81960-05	60V-81960-04	117
REC60V-81960-05	60V-81960-05	117
REC60X-44315-A0	60X-44315-A0	339-386
REC60X-W0078-00	60X-W0078-00	153-157-386
REC61A-11181-A0	61A-11181-00	249-254
REC61A-11193-A2	61A-11193-A2	255
REC61A-11381-A0	61A-11381-A0	276
REC61A-11650-00	61A-11650-00	261
REC61A-12414-A0	61A-12414-A0	138-231
REC61A-12414-A0	61A-12414-A0	237
REC61A-13411-00	61A-13411-00	83
REC61A-13621-A0	61A-13621-A0	276
REC61A-13645-00	61A-13645-00	276
REC61A-13646-00	61A-13646-00	276
REC61A-24563-00	61A-24563-00	81-82
REC61A-41134-A0	60D-41134-00	272
REC61A-44311-00	61A-44311-00	385
REC61A-44311-00	61A-44311-01	325-329-333-339-377-381-386
REC61A-44311-00	6E5-44311-00	148
REC61A-44311-00	61A-44311-00	155-156-157-158-159-160-161-162-163-164-165-166-167-168-169-170-171-172-173-174-175-176-177-178-179-180-181-182-183-184-185-186-187-188-189-190-191-192-193-194-195-196-197-198-199-200-201-202-203-204-205-206-207-208-209-210-211-212-213-214-215-216-217-218-219-220-221-222-223-224-225-226-227-228-229-230-231-232-233-234-235-236-237-238-239-240-241-242-243-244-245-246-247-248-249-250-251-252-253-254-255-256-257-258-259-260-261-262-263-264-265-266-267-268-269-270-271-272-273-274-275-276-277-278-279-280-281-282-283-284-285-286-287-288-289-290-291-292-293-294-295-296-297-298-299-300-301-302-303-304-305-306-307-308-309-310-311-312-313-314-315-316-317-318-319-320-321-322-323-324-325-326-327-328-329-330-331-332-333-334-335-336-337-338-339-340-341-342-343-344-345-346-347-348-349-350-351-352-353-354-355-356-357-358-359-360-361-362-363-364-365-366-367-368-369-370-371-372-373-374-375-376-377-378-379-380-381-382-383-384-385-386-387-388-389-390-391-392-393-394-395-396-397-398-399-400-401-402-403-404-405-406-407-408-409-410-411-412-413-414-415-416-417-418-419-420-421-422-423-424-425-426-427-428-429-430-431-432-433-434-435-436-437-438-439-440-441-442-443-444-445-446-447-448-449-450-451-452-453-454-455-456-457-458-459-460-461-462-463-464-465-466-467-468-469-470-471-472-473-474-475-476-477-478-479-480-481-482-483-484-485-486-487-488-489-490-491-492-493-494-495-496-497-498-499-500-501-502-503-504-505-506-507-508-509-510-511-512-513-514-515-516-517-518-519-520-521-522-523-524-525-526-527-528-529-530-531-532-533-534-535-536-537-538-539-540-541-542-543-544-545-546-547-548-549-550-551-552-553-554-555-556-557-558-559-560-561-562-563-564-565-566-567-568-569-570-571-572-573-574-575-576-577-578-579-580-581-582-583-584-585-586-587-588-589-590-591-592-593-594-595-596-597-598-599-600-601-602-603-604-605-606-607-608-609-610-611-612-613-614-615-616-617-618-619-620-621-622-623-624-625-626-627-628-629-630-631-632-633-634-635-636-637-638-639-640-641-642-643-644-645-646-647-648-649-650-651-652-653-654-655-656-657-658-659-660-661-662-663-664-665-666-667-668-669-670-671-672-673-674-675-676-677-678-679-680-681-682-683-684-685-686-687-688-689-690-691-692-693-694-695-696-697-698-699-700-701-702-703-704-705-706-707-708-709-710-711-712-713-714-715-716-717-718-719-720-721-722-723-724-725-726-727-728-729-730-731-732-733-734-735-736-737-738-739-740-741-742-743-744-745-746-747-748-749-750-751-752-753-754-755-756-757-758-759-760-761-762-763-764-765-766-767-768-769-770-771-772-773-774-775-776-777-778-779-780-781-782-783-784-785-786-787-788-789-790-791-792-793-794-795-796-797-798-799-800-801-802-803-804-805-806-807-808-809-810-811-812-813-814-815-816-817-818-819-820-821-822-823-824-825-826-827-828-829-830-831-832-833-834-835-836-837-838-839-840-841-842-843-844-845-846-847-848-849-850-851-852-853-854-855-856-857-858-859-860-861-862-863-864-865-866-867-868-869-870-871-872-873-874-875-876-877-878-879-880-881-882-883-884-885-886-887-888-889-890-891-892-893-894-895-896-897-898-899-900-901-902-903-904-905-906-907-908-909-910-911-912-913-914-915-916-917-918-919-920-921-922-923-924-925-926-927-928-929-930-931-932-933-934-935-936-937-938-939-940-941-942-943-944-945-946-947-948-949-950-951-952-953-954-955-956-957-958-959-960-961-962-963-964-965-966-967-968-969-970-971-972-973-974-975-976-977-978-979-980-981-982-983-984-985-986-987-988-989-990-991-992-993-994-995-996-997-998-999-1000

REF	R.O. / OEM	
REC61N-44322-00	61N-44322-01	154-155-297-355
REC61N-44323-00	61N-44323-00	149-154-155-297-355
REC61N-45510-00	61N-45510-00	355-388-389
REC61N-45510-10	61N-45510-10	355-388-389
REC61N-45551-00	61N-45551-00	355-388-389
REC61N-45560-10	61N-45560-00	295
REC61N-45560-10	61N-45560-10	355-388-389
REC61N-45570-00	61N-45571-00	355-388-389
REC61N-85540-00	61N-85540-00	119
REC61N-85570-01	61N-85570-01	105
REC61N-85570-01	61N-85570-01	105
REC61N-W0001-E1	61N-W0001-E1	145-354
REC61N-W0078-11	61N-W0078-11	150
REC61N-W0078-11	61N-W0078-11	65-66-150-154-155-297-354
REC61N-W0093-00	61N-W0093-00	93-96-229
REC61T-11193-A0	61T-11193-A1	229-255
REC61T-45113-A0	61T-45113-A0	253
REC61T-45113-A0	689-45113-A1	229
REC61T-45113-A0	61T-45113-A0	254
REC61T-W0001-02	61T-W0001-02	229-250-254-266-267-221-225-227-231-233-237-239-241-243
REC624-14485-00	624-14485-00	
REC624-42542-00	90387-06119	98
REC626-14390-90	626-14390-90	98
REC626-44365-01	626-44365-01	349-353
REC626-45316-09	626-45316-09	291-292-349
REC626-45316-09	90381-14020	351
REC62Y-15312-00	62Y-15312-00	271
REC62Y-41133-00	62Y-41133-00	268
REC62Y-45127-00	62Y-45127-00	268
REC62Y-46241-00	62Y-46241-00	207-267
REC62Y-W0001-22	62Y-W0001-20	146
REC62Y-W0001-22	62Y-W0001-21	146
REC62Y-W0001-22	62Y-W0001-22	146-306
REC634-11633-00	634-11633-00	227-260-262
REC63D-11181-A1	63D-11181-A2	237-248-254
REC63D-11193-A0	63D-11193-A0	237-255
REC63D-11603-00	63D-11603-00	237-263
REC63D-11605-00	63D-11605-00	237-263
REC63D-44311-01	63D-44311-00	148-156-309-313
REC63D-44312-00	63D-44312-00	301-305-309-313-317-361
REC63D-44316-00	63D-44316-00	301-305-309-313-361
REC63D-44322-00	63D-44322-00	154-156-301-305-309-313-317-361
REC63D-44323-00	63D-44323-00	305-309-313
REC63D-44323-00	63D-44323-00-00	149
REC63D-44323-00	63D-44323-00	154-156
REC63D-44341-00	63D-44341-00	301-309-361
REC63D-45114-A0	63D-45114-A0	272
REC63D-45123-00	63D-45123-00	269



REF	R.O. / OEM	
REC63P-82380-00	63P-82380-00	90-102
REC63V-11181-A1	63V-11181-A1	248
REC63V-11181-A1	63V-11181-A2	227-254
REC63V-11412-00	63V-11412-00	227-256
REC63V-11422-00	63V-11422-00	227-256
REC63V-11432-00	63V-11432-00	227-256
REC63V-11442-00	63V-11442-00	227-256
REC63V-11445-00	63V-11445-00	227
REC63V-11515-02	63V-11515-02	227
REC63V-14126-00	63V-14126-00	94
REC63V-14301-00	63V-14301-00	93
REC63V-14984-00	63V-14984-00	94
REC63V-14985-00	63V-14985-00	93-100
REC63V-15396-01-CA	63V-15396-01-CA	227
REC63V-24411-00	63V-24411-00	87
REC63V-41111-00-1S	63V-41111-00-1S	227
REC63V-41112-A0	63V-41112-A0	140-227
REC63V-41113-00-1S	63V-41113-00-1S	227
REC63V-41133-A1	63V-41133-A1	268
REC63V-44301-00	63V-44301-00	289-291-351
REC63V-44301-00-00	63V-44301-00-00	147
REC63V-44301-00	63V-44301-00	154-155
REC63V-44322-00	63V-44322-00	154-155-289-291-293-351
REC63V-44323-00	63V-44323-00	351
REC63V-44323-00-00	63V-44323-00-00	149
REC63V-44352-01	63V-44352-01	143-154-155-291-293-351
REC63V-44361-01	63V-44361-01	351
REC63V-44361-11	63V-44361-11	351
REC63V-44514-01-CA	63V-44514-01-CA	135
REC63V-45113-A1	63V-45113-A1	227-253-254
REC63V-45300-03-8D	63V-45300-03-8D	279
REC63V-45300-03-8D	63V-45300-03-8D	279
REC63V-45300-03-8D	63V-45300-03-8D	279
REC63V-45300-10-4D	63V-45300-10-4D	279
REC63V-45300-13-8D	63V-45300-13-8D	279
REC63V-45300-13-8D	63V-45300-13-8D	279
REC63V-45315-A0	63V-45315-A0	291-351
REC63V-45331-00-5B	63V-45331-00-5B	291-351
REC63V-45501-10	63V-45501-10	291-387-388
REC63V-45501-01	63V-45501-01	351-387-388
REC63V-45501-11	63V-45501-11	351-387-388
REC63V-45551-00	63V-45551-00	291-293-351-387-388
REC63V-85520-00	63V-85520-00	106
REC63V-85533-00	63V-85533-00	104
REC63V-85540-00-01	63V-85540-00-01	118-119
REC63V-85540-00-01	63V-85540-00-01	118-119
REC63V-85540-00-01	63V-85540-02	118
REC63V-85570-00	63V-85570-00	105
REC63V-85570-00	63V-85570-00	105
REC63V-85580-01	63V-85580-01	107
REC63V-W0001-00	63V-W0001-00	226
REC63V-W0001-00	63V-W0001-01	249-254
REC63V-W0001-21	63V-W0001-21	144
REC63V-W0078-01	63V-W0078-01	150
REC63V-W0078-01	63V-W0078-01	65-154-155-290-350
REC63V-W0093-00	63V-W0093-00	93-95-226
REC63W-13610-00	63W-13610-00	92-99
REC646-11633-00	646-11633-00	220
REC646-11651-02	646-11651-02	220-260
REC646-11681-00	646-11681-00	220-260
REC646-14623-A1	646-14623-A1	220-254-270
REC646-44322-00	646-44322-00	343
REC646-44323-00	646-44323-00	148-155-343
REC646-44352-01	646-44352-01	143-155-343
REC646-44365-00	646-44365-00	343
REC646-44366-01	646-44366-01	343
REC646-45551-00	646-45551-00	343-387
REC646-45560-00	646-45560-00	343-387
REC647-11610-00	647-11610-00	225-262-266
REC647-11610-10	647-11610-10	225
REC647-11610-20	647-11610-20	225
REC647-14323-00	647-14323-00	98
REC647-14385-00	647-14385-00	100
REC647-14386-10	647-14386-10	99
REC647-44366-00	647-44366-00	154-155-291-346-347-351
REC647-45316-09	647-45316-09	347
REC647-45551-00	647-45551-00	347-387
REC647-45560-00	647-45560-00	347-387
REC647-45570-00	647-45570-01	347-387
REC647-45616-02	647-45616-02	345
REC648-11633-00	648-11633-00	237-260-261-263-264
REC648-11651-00	648-11651-00	260-261
REC648-11681-00	648-11681-00	260
REC648-13621-A0	648-13621-A1	273
REC648-13645-A0	648-13645-A0	273
REC648-14198-A0	648-14198-A0	274
REC648-14384-01-00	648-14384-01	94
REC648-14385-00	648-14385-00	100
REC648-24411-00	648-24411-00	87
REC648-24434-01	648-24434-01	88
REC648-24435-02	648-24435-02	88
REC648-44146-00	648-44146-00	134
REC648-45633-00	648-45633-00	291-295-349-351-353-355-357
REC648-45633-00	648-45633-11	293
REC648-45633-00	648-45633-11	387-388-389
REC648-45635-00	648-45635-00	295-353-355
REC64D-11603-01	64D-11603-01	245

REF	R.O. / OEM	
REC64D-11603-01	64D-11603-02	247-265-266-267
REC64D-11604-01	64D-11603-04	265
REC64D-11604-01	64D-11604-01	245-247
REC64D-11604-01	64D-11604-02	247
REC64D-11605-01	64D-11603-05	265
REC64D-11605-01	64D-11605-01	245
REC64D-11605-01	64D-11605-02	247
REC64D-11631-00K	64D-11631-02-90	247-265-267
REC64D-11642-00K	64D-11642-02-90	247-265-267
REC64D-14384-1	64D-14384-01	94
REC64D-14394-00	64D-14394-00	99
REC64D-W0093-00	64D-W0093-00	97-247
REC64E-13645-A0	64E-13645-A0	276
REC64E-43821-05	64E-43821-00	125
REC64E-43822-00	64E-43822-00	125
REC64E-4384J-00	64E-4384J-00	125
REC64J-24560-10	64J-24560-10	80
REC64J-24560-10	64J-24560-10	80
REC64J-W0001-20	64J-W0001-20	145-146-333
REC64J-W0001-21	64J-W0001-21	146-333
REC650-11370-00	650-11370-00	231
REC650-11370-00	650-11370-01	225-235-237-239-241-243
REC650-11651-04	650-11651-00	227-260
REC650-14485-03	650-14485-03	227
REC650-24351-51	650-24351-00	75
REC650-24351-51	650-24351-01	75
REC650-24351-51	650-24351-50	75
REC650-24351-51	650-24351-51	75
REC650-24431-A0	650-24431-A0	88
REC650-44147-00	650-44147-00	134-363-367
REC650-45635-00	650-45635-00	291-293-349-351
REC655-12414-A1	655-12414-A1	138-229
REC65L-13645-00	65L-13645-00	275
REC65L-13646-00	65L-13646-00	275
REC65L-13915-00	65L-13915-00	82
REC65L-24563-00	65L-24563-00	71-72-81-82
REC65N-45321-00	65N-45321-00	335
REC65N-W0078-A1	65N-W0078-A1	152-157
REC65W-46241-00	65W-46241-00	193-199-267
REC65W-82575-01	65W-82575-01	120
REC65W-W0001-00	65W-W0001-00	217
REC65W-W0001-00	65W-W0001-02	190
REC65W-W0001-00	65W-W0001-02	218
REC65W-W0001-20	65W-W0001-20	145-297
REC662-44352-01	662-44352-01	143-347
REC663-11193-00	663-11193-A0	239-255
REC663-11411-01	663-11411-01	239-256
REC663-11561-00	663-11561-00	239
REC663-11633-00	663-11633-00	239-243-260-261-264
REC663-11634-00	663-11634-00	233-263
REC663-11634-00	663-11634-00	235-263
REC663-12414-A0	663-12414-A0	138-239
REC663-12416-00	663-12416-00	235-239
REC663-13621-01	663-13621-A0	275
REC663-14198-00	663-14198-A0	275
REC663-14483-A0	663-14483-A0	275
REC663-14548-00	663-14548-00	99
REC663-14923-00	663-14923-00	99
REC663-24411-00	663-24411-00	87
REC663-41114-00	663-41114-A0	142-239
REC663-42138-00	663-42138-00	130
REC663-43118-01-4D	663-43118-01-4D	134
REC663-44144-01	663-44144-01	369-371
REC663-44151-00	663-44151-00	369-371
REC663-44311-02	663-44311-02	359-369
REC663-44311-02	663-44311-02-00	147
REC663-44311-02	663-44311-02	369
REC663-44311-02	663-44311-02	357
REC663-44311-02	663-44311-02	155-156
REC663-44315-A0	663-44315-A0	155-156-357-359-369
REC663-44316-A0	663-44316-A0	357-359-369
REC663-44322-00	663-44322-00	154-155-156-357-359-369
REC663-44323-00	663-44323-00	149-155-156-357-359-369
REC663-44324-00	663-44324-A0	357-359-369
REC663-44366-00	663-44366-00	301-305-309-313-317-321-333-357-359-361-363-367-369-371-373-385
REC663-44366-00	663-44366-00	154-155-156
REC663-44551-02-8D	663-44551-02-8D	135
REC663-45123-00	663-45123-00	268
REC663-45331-00-94	663-45331-00-94	369-390
REC663-45375-00	663-45375-00	367
REC663-45376-00	663-45376-00	305-325-335-367
REC663-45376-00	663-45376-00-94	301-309-313-317-321-329
REC663-45510-01	663-45510-01	369-390
REC663-45552-00	663-45552-00	359-365-369
REC663-45576-00	663-45576-00	365
REC663-45631-01	663-45631-01	359-363-365-369-389-390
REC663-45633-00	663-45633-00	359-361-363-365-369-389-390
REC663-45634-00	663-45634-00	303-307-311-359-363-365-369

REF	R.O. / OEM	
REC663-45987-00	663-45987-00	365
REC663-45987-00	663-45987-02	299-303-307-311-359-361-369
REC663-45987-00	663-45987-02	405
REC663-48344-00	663-48344-00	127
REC663-85518-00	663-85518-00	132
REC663-85540-11	663-85540-11	119
REC663-85540-15	663-85540-15	119
REC663-W0078-01	663-W0078-00	368
REC663-W0078-01	663-W0078-01	152-368
REC663-W0078-01	663-W0078-A0	151
REC663-W0078-01	663-W0078-A0	156
REC664-41114-A0	664-41114-A0	140
REC664-41134-A0	664-41134-A0	268
REC664-44338-00	63V-44338-00	351
REC664-44338-00	664-44338-00	289-291-293-353
REC664-44338-00	664-44338-00	154-155
REC664-45384-00	664-45384-00	353-357
REC664-45631-00	664-45631-02	355-388-389
REC664-45631-01	664-45631-01	353
REC664-45987-00	664-45987-00	353
REC66K-13907-00	66K-13907-00	86
REC66K-13915-00	66K-13915-00	82
REC66K-14984-00	66K-14984-00	86-88
REC66K-45501-00	66K-45501-00	385
REC66M-46241-00	66M-46241-00	185-267
REC66M-W0001-01	66M-W0001-01	182-216-218
REC66M-W0001-20	66M-W0001-20	144-290
REC66M-W0093-01	66M-W0093-01	95-182
REC66N-11603-00	66N-11603-00	183-219
REC66T-11181-00	66T-11181-A0	249
REC66T-11181-00	66T-11181-A2	233-254
REC66T-11193-A0	66T-11193-A0	233-255
REC66T-11412-00	66T-11412-00	233-256
REC66T-11422-00	66T-11422-00	233-256
REC66T-11432-00	66T-11432-00	233-256
REC66T-11442-00	66T-11442-00	233-256
REC66T-11603-00	66T-11603-00	233-263-266
REC66T-11604-00	66T-11604-00	233-263
REC66T-11605-00	66T-11605-00	233-263
REC66T-11631-01-93	66T-11631-01-93	233-263-266
REC66T-11635-01	66T-11635-01	233-263
REC66T-11636-01K	66T-11636-01	233-263
REC66T-11681-01	66T-11681-01	233-260-261
REC66T-14301-60	66T-14301-60	92-93
REC66T-14384-01	66T-14384-01	94
REC66T-14536-01	66T-14536-01	94
REC66T-14992-00	66T-14992-00	99
REC66T-15713-00	66T-15713-00	112



REF	R.O. / OEM	
REC676-43160-02	676-43160-02	132
REC676-44311-00	676-44311-00	148-156-363-367
REC676-44315-00	676-44315-A0	367
REC676-44315-A1	676-44315-A1	156-363
REC676-44316-A1	676-44316-A1	363
REC676-44322-00	676-44322-00	156-367
REC676-44323-00-40	676-44323-00	149-156-367-363
REC676-44324-A0	676-44324-A0	367
REC676-44324-A0	676-44324-A1	363
REC676-44341-00	676-44341-94	363
REC676-44361-00	676-44361-00	367
REC676-44361-10	676-44361-10	367
REC676-44518-00	676-44518-00	135
REC676-45114-A1	676-45114-A1	271
REC676-45127-00	676-45127-00	269
REC676-45128-00	676-45128-00	269
REC676-45314-00	676-45314-00	363
REC676-45361-00	676-45361-01-94	363-390
REC676-45501-10	676-45501-10	363-389-390
REC676-45533-00	676-45533-00	363
REC676-45587-00	676-45587-00-70	363
REC676-45587-00-75	676-45587-00-75	363
REC676-45587-00-80	676-45587-00-80	363
REC676-45635-00	676-45635-00	359-363-365
REC677-11181-A0	677-11181-A1	225-248-254
REC677-11412-02	677-11412-02	225-256
REC677-11422-02	677-11422-02	225-256
REC677-11432-02	677-11432-02	225-256
REC677-11442-02	677-11442-02	225-256
REC677-11631-00K	677-11631-00-97	225-262-266
REC677-11635-00K	677-11635-00	225-262
REC677-11636-00K	677-11636-00	225-262
REC677-11651-00	677-11650-01	260
REC677-13621-00	677-13621-A1	273
REC677-14198-A1	677-14198-A1	273
REC677-14227-00	677-14227-01	94
REC677-14343-68	677-14343-68	98
REC677-14384-01	677-14384-01	94
REC677-24434-02	677-24434-02	273
REC677-24435-01	677-24435-01	87
REC677-24471-01	677-24471-01	87
REC677-26301-02	677-26301-02	129
REC677-41112-A0	677-41112-A1	225
REC677-41112-A0	677-41114-A0	140
REC677-41112-A0	677-41114-A1	225-389
REC677-45113-A0	677-45113-A0	225-252-254
REC677-W0093-00	677-W0093-00	95-225
REC679-14923-00	679-14923-00	99
REC679-44150-00	679-44150-00	367
REC679-44150-10	679-44150-10	367
REC679-44152-00	679-44152-00	367
REC679-44316-A0	679-44316-A0	367
REC679-44341-00	679-44341-00-94	367
REC679-44514-00-94	679-44514-00-94	135
REC679-45315-A1	679-45315-A1	365
REC679-45321-02	679-45321-02	365
REC679-45331-00	679-45331-00-94	365
REC679-45501-10	679-45501-10	367-389
REC679-45536-00	679-45536-00	367
REC679-45560-00	679-45560-00	365-389
REC679-45571-00	679-45571-00	365
REC679-45611-00	679-45611-01	359-365-389-390
REC679-W0078-A1	679-W0078-00	151-156
REC67C-11181-01	67C-11181-01	197-215-218
REC67C-11351-00	67C-11351-01	197-207-218
REC67C-11356-00	67C-11356-00	197
REC67C-11603-00	67C-11603-00	193-195-199-201-203-205-219
REC67C-15312-00	67C-15312-00	271
REC67C-41114-00	67C-41114-00	141
REC67C-41114-00	67C-41114-10	197
REC67C-41133-00	67C-41133-00	268
REC67C-43880-01	67C-43880-01	122
REC67C-43880-01	67C-43880-01	122
REC67C-45113-00	67C-45113-00	271
REC67C-45123-00	67C-45123-00	268
REC67C-45501-00	67C-45501-00	301-305-389-390
REC67C-45501-10	67C-45501-10	301-305-389-390
REC67C-W0001-01	67C-W0001-00	217
REC67C-W0001-01	67C-W0001-01	197-217-218
REC67C-W0001-20	67C-W0001-20	298
REC67D-W0093-00	67D-W0093-00	95-177
REC67F-11181-03	67F-11181-02	209
REC67F-11181-03	67F-11181-03	215-218
REC67F-11328-00	67F-11328-00	209-211-214
REC67F-11416-00	67F-11416-00	209
REC67F-11416-10	67F-11416-10	209
REC67F-11416-20	67F-11416-20	209
REC67F-12411-01	67F-12411-00	137
REC67F-12411-01	67F-12411-01	69-70-71-72-73-137-209-211-213
REC67F-14371-01	67F-14371-01	101
REC67F-41114-A2	67F-41114-A0	209
REC67F-41134-A0	67F-41134-A0	269
REC67F-41138-00	67F-41138-00	269
REC67F-44311-01	67F-44311-00	321
REC67F-44311-01	67F-44311-01-00	148-154-155
REC67F-44322-00	67F-44322-00	321-154-155

REF	R.O. / OEM	
REC67F-44323-00	67F-44323-00	149-154-155-321
REC67F-44352-00	67F-44352-00	143-321-154-155
REC67F-45113-00	67F-45113-00	272
REC67F-45123-00	67F-45123-00	269
REC67F-45127-00	67F-45127-00	269
REC67F-45331-00-CA	67F-45331-00-94	319
REC67F-45501-10	67F-45501-10	321-391
REC67F-45560-00	67F-45560-00	319-390-391
REC67F-45570-00	67F-45570-00	391
REC67F-45576-00	67F-45576-00	315-319
REC67F-45611-01	67F-45611-01	315-319-391
REC67F-45997-00	67F-45997-00	315-319-371-405
REC67F-46241-00	67F-46241-00	209-267
REC67F-81960-12	67F-81960-00	116
REC67F-85570-00	67F-85570-00	105
REC67F-W0001-00	67F-W0001-00	217
REC67F-W0001-01	67F-W0001-01	209
REC67F-W0001-02	67F-W0001-02	218
REC67F-W0001-20	67F-W0001-20	145-318
REC67F-W0078-00	67F-W0078-00	69-70-152-154-155-318
REC67F-W0093-00	67F-W0093-00	97-209
REC67H-11411-00	67H-11411-00	256
REC67H-13907-00	67H-13907-00	86
REC67H-8592A-01	67H-8592A-01	103
REC682-11351-A0	682-11351-A0	253
REC682-11412-00	682-11412-00	256
REC682-11422-00	682-11422-00	256
REC682-11432-00	682-11432-00	256
REC682-11442-00	682-11442-00	256
REC682-11610-01	682-11610-01	262
REC682-11610-01	682-11610-01	227-266
REC682-11610-11	682-11610-11	227-262
REC682-11610-21	682-11610-21	227-262
REC682-11681-00	682-11681-00	227-260
REC682-12413-00-1S	682-12413-00-1S	139-227
REC682-12413-00-1S	682-12413-00-9M	139
REC682-12414-A1	682-12414-A1	138-139-227
REC682-13621-A0	682-13621-A0	273
REC682-41112-00	682-41112-A1	140
REC682-41114-00	682-41114-A1	140
REC682-41133-A0	682-41133-A0	268
REC682-41237-00	682-41237-00	132
REC682-41237-50	682-41237-50	132
REC682-44147-00	682-44147-00	349-357
REC682-44176-00	682-44176-00	349
REC682-44312-00	682-44312-00	349
REC682-44315-00	682-44315-00	154-155-156-349
REC682-44322-00	682-44322-00	154-155-156-349
REC682-44323-00	682-44323-00	154-155-156-349
REC682-44328-00	682-44328-00	349
REC682-44352-01	682-44352-00	349
REC682-44352-01	682-44352-03	143-154-155-156
REC682-44361-01	682-44361-01	349
REC682-44361-10	682-44361-10	349
REC682-44365-00	682-44365-00	154-155-156-349
REC682-44514-01-94	682-44514-01-94	135
REC682-45113-A0	682-45113-02	254-271
REC682-45376-01	682-45376-01	349
REC682-45631-00	682-45631-00	291-293-349-351-387-388
REC682-W0078-A1	682-W0078-A1	150-154-155-156-348
REC683-44362-01	683-44361-01	349
REC683-44365-01	683-44365-01	349
REC683-44373-00	683-44373-00	349
REC683-45315-A0	683-45315-00	349
REC683-45361-01-4D	683-45361-01-EJ	349
REC683-45361-01-4D	683-45361-02-4D	291-351
REC683-45361-01-4D	683-45361-02-8D	293
REC683-45361-02-4D	683-45361-02-8D	387-388
REC683-45611-00	683-45611-00	291-293-349-351-387-388
REC683-W0001-21	683-W0001-21	348
REC683-W0001-21	683-W0001-C1	144
REC688-11111-02-1S	688-11111-02-1S	243
REC688-11181-A1	688-11181-A1	243
REC688-11181-A1	688-11181-A2	249-254
REC688-11193-A1	688-11193-A1	243-255
REC688-11370-00	688-11370-01	237-241-243
REC688-11411-00	688-11411-01	243-256
REC688-11603-A0	688-11603-A0	239-243-264-266
REC688-11605-A0	688-11605-A0	239-243-264
REC688-11610-02	688-11610-02	264-266
REC688-11631-02K	688-11631-02-95	264-266
REC688-11631-03K	688-11631-03-94	239-243-264
REC688-11631-81K	688-11631-81-96	264-266
REC688-11634-00	688-11634-00	229-239-243-263-264
REC688-11634-00	688-11634-10	241
REC688-11635-03K	688-11635-03	239-264
REC688-11636-03K	688-11636-03	264
REC688-11636-03K	688-11636-03	239
REC688-11650-03	688-11650-03	239-243-264
REC688-11651-00	688-11651-00	261
REC688-12413-00-1S	688-12413-00-1S	139-243
REC688-12414-A1	688-12414-A1	138-139-243-245-247

REF	R.O. / OEM	
REC688-12416-00	688-12416-00	139-243
REC688-13610-00	688-13610-00	99
REC688-13621-A1	688-13621-A1	274
REC688-14198-A1	688-14198-A2	274
REC688-14416-01	688-14416-01	274
REC688-14483-A0	688-14483-A0	274
REC688-14548-00	688-14548-00	99
REC688-14947-00	688-14947-00	98
REC688-41112-A0	688-41112-A0	142-243
REC688-41114-A0	688-41114-A0	142-243
REC688-41134-00	688-41134-A0	269
REC688-41211-01	688-41211-00	132
REC688-41211-01	688-41211-01	132
REC688-41217-00	688-41217-00	101
REC688-43160-01	688-43160-01	132
REC688-44120-12	688-44120-11	134
REC688-44120-12	688-44120-12	134
REC688-44120-22	688-44120-22	134
REC688-44311-01	688-44311-01	148-371
REC688-44311-01	688-44311-01	156
REC688-44311-01	688-44311-01-00	373
REC688-44315-00	688-44315-A0	321-371
REC688-44315-00	688-44315-A0-00	154-155-156
REC688-44316-00	688-44316-00	373
REC688-44316-00	688-44316-A0	371
REC688-44316-00	688-44316-A0-00	373
REC688-44322-00	688-44322-00	156-371
REC688-44322-00	688-44322-00-00	373
REC688-44323-00	688-44323-00-00	149-373
REC688-44323-00	688-44323-00	156-371
REC688-44324-00	688-44324-A0	321-371
REC688-44324-00	688-44324-A0-00	373
REC688-44341-01	688-44341-01-94	371
REC688-44341-01	688-44341-01	321
REC688-44341-01	688-44341-01-94	373
REC688-44352-03	688-44352-03	143-156-371
REC688-44352-03	688-44352-03-00	373
REC688-44361-10	688-44361-10	371
REC688-44514-00	688-44514-00	135
REC688-44555-00	688-44555-00	135
REC688-45113-A0	688-45113-A0	243-253-254
REC688-45114-A1	688-45114-A1	272
REC688-45123-00	688-45123-00	269
REC688-45214-02	688-45214-02	323-365
REC688-45215-02	688-45215-02	323-365
REC688-45331-00-94	688-45331-00-94	371-373-388-390-391
REC688-45341-00	688-45341-00	295-359-375
REC688-45341-00	688-45341-00-00	373
REC688-45341-00	688-45341-10	299-303-307-311-315-319-323-327-331-3



REF	R.O. / OEM	
REC689-11610-00	689-11610-01	263-266
REC689-11631-00K	689-11631-00-95	263-266
REC689-11633-00	689-11633-00	229-260-263
REC689-11651-00	689-11651-00	229-260-261
REC689-11681-00	689-11681-01	229-260-261
REC689-15396-01-CA	689-15396-01-5B	229
REC689-15755-00	689-15755-00	134
REC689-41112-A0	689-41112-A0	141
REC689-41114-A0	689-41114-A0	141
REC689-44311-00	689-44311-03	147-155-353
REC689-44315-A0	689-44315-A0	353
REC689-44316-A0	689-44316-A0	353
REC689-44323-00	689-44323-03	155-353
REC689-44324-A0	689-44324-A0	155-353
REC689-44352-02	689-44352-02	143-155-353
REC689-44366-00	689-44366-00	155-353-355
REC689-45501-00	689-45501-10	353-388-389
REC689-45551-00	689-45551-00	353-388-389
REC689-45560-00	689-45560-00	353-388-389
REC689-45571-00-00	689-45570-00	353-388-389
REC689-45611-00	689-45611-00	353-388-389
REC689-45997-00	689-45997-00	295-353-355-357-405
REC689-81311-40	66M-85570-00	105
REC689-85540-21	689-85540-20	119
REC689-85540-21	689-85540-21	119
REC689-W0001-20	689-W0001-20	145
REC689-W0001-21	689-W0001-21	145-353
REC689-W0001-C2	689-W0001-C2	145
REC689-W0078-04	689-W0078-04	151-155
REC689-W0078-A6	689-W0078-A6	151-155-353
REC689-W0093-02	689-W0093-02	95
REC689-W4432-01	689-W4432-02	155-156-353
REC68D-E1603-00	68D-E1603-00	175-219
REC68F-11181-00	68F-11181-00	249-254
REC68F-11193-02	68F-11193-02	255
REC68F-11381-00	68F-11381-00	276
REC68F-13440-00	68F-13440-00	83
REC68F-13907-01	68F-13907-01	86
REC68F-13915-00	68F-13915-00	82
REC68F-24563-00	68F-24563-00	81
REC68F-24563-10	68F-24563-10	81
REC68F-41114-00	68F-41114-00	142
REC68F-45113-01	68F-45113-01	253-254
REC68F-8195A-00	68F-8195A-00	115
REC68F-83688-00	68F-83688-00	90-102
REC68F-83688-10	68F-83688-10	90-102
REC68F-8592A-00	68F-8592A-00	103
REC68F-W0001-01	68F-W0001-01	252-254
REC68T-13475-00	68T-13475-00	271
REC68T-24251-00	68T-24251-00	80-82
REC68T-24251-00	68T-24251-01	80
REC68T-24251-00	6EE-F4251-00	80
REC68T-24251-00	68T-24251-00	64-65-81
REC68T-24410-00-00	68T-24410-00	85
REC68T-24410-00-00	68T-24410-01	85
REC68T-44323-00	68T-44323-00	149-154-289-293
REC68T-44352-00	68T-44352-00	143-154-289
REC68T-44366-00	68T-44366-00	154-289
REC68T-45551-A0	6N0-G5551-A0	289
REC68T-46241-00	60R-G6241-00	180
REC68T-46241-00	68T-46241-00	267
REC68T-85540-00	68T-85540-00	118
REC68T-W0001-20	68T-W0001-20	144-289
REC68T-W0078-00	68T-W0078-00	150-289
REC68T-W0078-00	68T-W0078-01	64-65-150-154
REC68V-11351-00	68V-11351-00	209-218
REC68V-12111-00	68V-12111-00	209
REC68V-13761-10	68V-13761-10	90
REC68V-13907-00	68V-13907-00	86
REC68V-13907-00	68V-13907-01	86
REC68V-13907-00	68V-13907-02	86
REC68V-13907-00	68V-13907-03	86
REC68V-13907-00	68V-13907-04	86
REC68V-13915-00	68V-13915-00	72-82
REC68V-14984-00	68V-14984-00	72-86-88
REC68V-15312-00	68V-15312-00	272
REC68V-24410-00	68V-24410-00	85
REC68V-24563-00	68V-24563-00	68-80-81-82
REC68V-44323-00	6EK-44323-00	149-155-269-325
REC68V-45123-00	68V-45123-00	269
REC68V-45501-10	68V-45501-10	325
REC68V-81950-00	68V-81950-00	115
REC68V-82380-00	68V-82380-00	90-102
REC68V-85885-00	68V-85885-00	90-102
REC68V-8A360-00	68V-13761-00	89
REC68V-8A360-00	68V-8A360-00	89-90
REC68V-W0001-20	68V-W0001-20	147-322
REC68V-W0078-00	68V-W0078-00	70-71-152-155-322
REC692-14590-01	692-14590-00	98
REC692-14590-01	692-14590-01	98
REC692-14923-00	692-14923-00	98
REC692-24410-00	692-24410-00	85
REC692-24410-00	6A0-24410-00	85
REC692-24410-00	6A0-24410-03	85
REC692-24410-00	6A0-24410-04	85
REC692-24410-00	6A0-24410-05	85
REC692-24411-00	692-24411-00	87
REC692-26301-03	692-26301-00	129
REC692-26301-03	692-26301-01	129
REC692-26301-03	692-26301-02	129
REC692-26301-03	692-26301-03	129

REF	R.O. / OEM	
REC692-41256-00	692-41256-00	101
REC692-44120-22	692-44120-21	134
REC692-44120-22	692-44120-22	134
REC692-45300-16-8D	692-45300-12-4D	280
REC692-45300-16-8D	692-45300-13-4D	280
REC692-45300-16-8D	692-45300-14-4D	280-370
REC692-W0078-02	692-W0078-00-00	373
REC692-W0078-02	692-W0078-01-00	373
REC692-W0078-02	692-W0078-00	152
REC692-W0078-02	692-W0078-01	152
REC692-W0078-02	692-W0078-02	152-156-370
REC695-11181-00	695-11181-A1	248-254
REC695-85540-11	695-85540-11	119
REC695-85540-11	695-85540-12	119
REC695-W0001-A2	695-W0001-01	250-254
REC696-14590-01	696-14590-01	98
REC696-45113-00	696-45113-00	239
REC696-45113-00	696-45113-A0	253-254
REC696-85540-12	696-85540-10	119
REC696-85540-12	696-85540-11	119
REC696-85540-12	696-85540-12	119
REC696-W0093-00	696-W0093-00	239
REC696-W0093-00	696-W0093-02	96
REC697-11181-A1	697-11181-A2	239-249-254
REC697-45114-00	697-45114-A0	254-271
REC697-45384-00	697-45384-00	359-365-369
REC697-45551-00	697-45551-00	369-390
REC697-45560-00	697-45560-00	369-390
REC697-45570-00	697-45571-00	369
REC697-45571-00-00	697-45571-00	390
REC697-45611-00	697-45611-00	369-388-390
REC697-85570-00	697-85570-00	105
REC697-85570-10	697-85570-10	105
REC697-W0001-02	697-W0001-01	239
REC697-W0001-02	697-W0001-A0	251
REC697-W0001-02	697-W0001-A0	254
REC698-W0001-21	698-W0001-21	145-368
REC69D-45501-10	69D-45501-10	390
REC69D-W0001-20	69D-W0001-20	146
REC69G-45510-10	69G-45510-10	387
REC69G-45510-20	69G-45510-20	387
REC69G-W0001-20	69G-W0001-20	144-289
REC69G-W0078-01	69G-W0078-01	150
REC69G-W0078-01	69G-W0078-01	150
REC69J-11181-03	69J-11181-03	216-218
REC69J-11182-03	69J-11182-03	216-218
REC69J-11351-11	69J-11351-11	213-218
REC69J-12111-00	69J-12111-00	211
REC69J-12119-00	69J-12119-00	211
REC69J-13645-00	69J-13645-A1	273
REC69J-13761-00	69J-13761-00	90
REC69J-13906-00	69J-13906-00	89-90
REC69J-13907-03	69J-13907-00	86
REC69J-13907-03	69J-13907-01	86
REC69J-13907-03	69J-13907-02	86
REC69J-13907-03	69J-13907-03	86
REC69J-13907-03	69J-13907-04	86
REC69J-15451-00	69J-15451-00	213
REC69J-15451-00	69J-15451-A1	273
REC69J-24410-02	69J-24410-00	86
REC69J-24410-02	69J-24410-01	86
REC69J-24501-10	69J-24501-10	71-72-81
REC69J-24502-00	69J-24502-00	81
REC69J-41134-A0	69J-41134-A0	270
REC69J-41135-A0	69J-41135-A0	270
REC69J-41138-00	69J-41138-00	270
REC69J-45123-00	69J-45123-00	270
REC69J-45361-00-8D	69J-45361-00-8D	331-383
REC69J-45375-00	69J-45375-00	331-383
REC69J-45611-00	69J-45611-00	331-337-392
REC69J-45631-00	69J-45631-00	331-337-392
REC69J-46241-00	69J-46241-00	267
REC69J-81960-13	69J-81960-10	116
REC69J-81960-13	69J-81960-11	116
REC69J-81960-13	69J-81960-12	116
REC69J-81960-13	69J-81960-13	116
REC69J-85885-00	69J-85885-00	90-102
REC69J-W0001-20-00	69J-W0001-20	147
REC69K-45611-00	69K-45611-00	331-337
REC69L-11635-00-85	69L-11635-00-85	267
REC69L-11642-00	69L-11642-00-85	267
REC69M-E1603-01	69M-E1603-01	173-219
REC69P-85541-09	69P-85541-09	106
REC69W-82575-00	69W-82575-00	120
REC6A0-14325-00	6A0-14325-00	99
REC6A0-24410-04	6A0-24410-00	85
REC6A0-24410-04	6A0-24410-01	85
REC6A0-24410-04	6A0-24410-02	85
REC6A0-24410-04	6A0-24410-03	85
REC6A0-24410-04	6A0-24410-04	85
REC6A0-82550-01	6A0-82550-01	120
REC6A0-W0001-21	6A0-W0001-21	146
REC6A1-14301-03	6A1-14301-03	92-93
REC6A1-14613-A0	6A1-14613-00	270
REC6A1-14613-A0	6A1-14613-01	270
REC6A1-14613-A0	6A1-14613-A0	220-270
REC6A1-44325-00P	6A1-44325-00P	343
REC6A1-44361-00	6A1-44361-00	343
REC6A1-85540-00	6A1-85540-00	118
REC6A1-85540-01	6A1-85540-01	118
REC6A1-85570-00	6A1-85570-00	105
REC6A1-85570-00	6A1-85570-00	144
REC6A1-W0001-22	6A1-W0001-22	144
REC6A1-W0001-23	6A1-W0001-23	144-343

REF	R.O. / OEM	
REC6A1-W0078-01	6A1-W0078-01	150-155-343
REC6A1-W0093-01	6A1-W0093-01	93-95
REC6AG-11181-00	6AG-11181-00	215
REC6AG-11181-00	6AG-11181-10	187-218
REC6AH-11351-00	6AH-11351-10	187-218
REC6AH-12411-00	69M-12411-00	136
REC6AH-12411-00	69M-12411-01	136-173-175
REC6AH-12411-00	6G8-12411-00	136-187
REC6AH-12411-00	6G8-12411-01	181
REC6AH-12411-00	6AH-12411-00	65-137
REC6AH-13329-00	6AH-13329-00	271
REC6AH-15312-00	6AH-15312-00	271
REC6AH-W0078-00	6AH-W0078-00	150-153-292
REC6AH-W0078-00	6AH-W0078-01	150-292
REC6AH-W0078-00	6AH-W0078-01	65-154
REC6AW-11181-00	6AW-11181-00	214-216-218
REC6AW-11182-00	6AW-11182-00	214-216-218
REC6AW-11351-00	6AW-11351-00	214-218
REC6AW-12411-00	6AW-12411-00	73-137-214
REC6AW-13907-00	6AW-13907-00	86
REC6AW-13907-00	6P2-13907-00	86
REC6AW-14613-00	6AW-14613-00	272
REC6AW-14623-00	6AW-14623-00	272
REC6AW-14984-00	65L-13907-00	86
REC6AW-14984-00	66K-13907-00	86
REC6AW-14984-00	67H-13907-00	86
REC6AW-14984-00	6AW-14984-00	73-88
REC6AW-15312-00	6AW-15312-00	272
REC6AW-15451-00	6AW-15451-00	214-272
REC6AW-41134-01	6AW-41134-00	270
REC6AW-43880-02	6AW-43880-00	123
REC6AW-43880-02	6AW-43880-01	123
REC6AW-43880-02	6AW-43880-02	123
REC6AW-44311-01	6AW-44311-00	148-341
REC6AW-44311-01	6AW-44311-01	148
REC6AW-44312-00	6AW-44312-00	335-341
REC6AW-44315-00	6AW-44315-00	341
REC6AW-44322-00	6AW-44322-00	335-341
REC6AW-44323-00	6AW-44323-00	341
REC6AW-44336-00	6AW-44336-00	341

REF	R.O. / OEM	
REC6D8-WS24A-00	6D8-24563-00	80
REC6D8-WS24A-00	6D8-WS24A-00	66-67-68-69-70-71-80-81
REC6D9-12411-00	6D9-12411-00	70-137
REC6D9-45551-00	6D9-45551-00	319
REC6DA-11181-00	6DA-11181-00	216-218
REC6DA-12411-01	6DA-12411-01	72-136-137
REC6DA-13761-00	6DA-13761-00	90
REC6E0-11193-A1	6E0-11193-A1	221
REC6E0-11631-00-98K	6E0-11631-00-98	221-262-266
REC6E0-11651-01	6E0-11651-01	221-225-260
REC6E0-24411-00	6E0-24411-00	87
REC6E0-24434-00	6G1-24431-01	87
REC6E0-24435-00	6E0-24435-00	87
REC6E0-24471-00	6E0-24471-00	87
REC6E0-26301-01	6E0-26301-01	129
REC6E0-41112-A1	6E0-41112-A1	140-21
REC6E0-41114-A1	6E0-41114-A1	140-221
REC6E0-43118-01	6E0-43118-00	134
REC6E0-43118-01	6E0-43118-01	134
REC6E0-44322-02	6E0-44322-02	154-155-345
REC6E0-44352-00	6E0-44352-00	143-154-155-287-345
REC6E0-45113-A1	6E0-45113-A1	221-252
REC6E0-45316-00	6E0-45316-09	345
REC6E0-45317-00	6E0-45317-09	345
REC6E0-45511-01	6E0-45511-01	345-387
REC6E0-45511-11	6E0-45511-11	345-387
REC6E0-45551-00	6E0-45551-00	345-387
REC6E0-45560-00	6E0-45560-00	345-387
REC6E0-45570-00	6E0-45570-00	345-387
REC6E0-45611-01	6E0-45611-01	345
REC6E0-45631-00	6E0-45631-00	345-387
REC6E0-85540-71	6E0-85540-70	119
REC6E0-85540-71	6E0-85540-71	119
REC6E0-85570-00	6E0-85570-00	104
REC6E0-W0001-C1	6E0-W0001-C1	144-285-345
REC6E0-W0078-A2	6E0-W0078-00	150-153
REC6E0-W0078-A2	6E0-W0078-01	150-153
REC6E0-W0078-A2	6E0-W0078-02	150-153
REC6E0-W0078-A2	6E0-W0078-A2	150-153-155-285-345
REC6E3-14301-05	6E3-14301-05	92-93
REC6E5-11181-A0	6E5-11181-A2	245-249-254
REC6E5-11193-A0	6E5-11193-A0	245-255
REC6E5-11381-A1	6E5-11381-A1	275
REC6E5-11381-A1	6E5-11381-A2	245-247
REC6E5-11411-00	6E5-11411-00	256
REC6E5-11447-00	6E5-11447-00	245-247
REC6E5-11610-02	6E5-11610-02	265-266-267
REC6E5-11633-00	6E5-11633-01	261-265
REC6E5-11634-00	6E5-11634-00	265
REC6E5-11650-01	6E5-11650-01	261
REC6E5-11651-00	6E5-11651-00	261
REC6E5-12411-02	6E5-12411-00	136
REC6E5-12411-02	6E5-12411-01	136-221-223-229-231-233
REC6E5-12411-02	6E5-12411-02	136-137
REC6E5-12411-30	6E5-12411-10	243
REC6E5-12411-30	6E5-12411-10	137
REC6E5-12411-30	6E5-12411-20	137
REC6E5-12411-30	6E5-12411-30	137-227-237-245-247
REC6E5-12411-30	6E5-12411-30	137
REC6E5-13411-00	6E5-13411-00	83
REC6E5-13621-A1	6E5-13621-A1	275
REC6E5-13645-A1-00	6E5-13645-A1	275
REC6E5-14198-A2	6E5-14198-A2	275
REC6E5-14323-03	6E5-14323-03	99
REC6E5-14328-01	6E5-14328-01	99
REC6E5-14385-02	6E5-14385-02	93-100
REC6E5-14386-01	6E5-14386-01	99
REC6E5-14386-02	6E5-14386-02	99
REC6E5-14416-A1	6E5-14416-A1	275
REC6E5-14483-A1	6E5-14483-A1	275
REC6E5-14546-00	6E5-14546-00	93-98
REC6E5-24351-51	6E5-24351-51	75
REC6E5-24351-51	6E5-24351-51	75
REC6E5-24410-03	6E5-24410-01-00	85
REC6E5-24411-00	6E5-24411-00-00	87
REC6E5-24434-02	6E5-24434-02	88
REC6E5-24435-00	6E5-24435-00	88
REC6E5-24471-00	6E5-24471-00	87
REC6E5-41112-A1	6E5-41112-A1	142-245
REC6E5-41134-A0	6E5-41134-A0	269-270
REC6E5-44150-02	6E5-44150-01	377
REC6E5-44311-00	6E5-44311-00	155-156-157-381
REC6E5-44312-00	6E5-44312-00	325-329-333-339-385-386
REC6E5-44315-A0	6E5-44315-A0	156-157-325-329-333-377-381-385
REC6E5-44322-00	6E5-44322-00	156-157-381
REC6E5-44323-00-40	6E5-44323-00	149-155-156-157-377
REC6E5-44352-01	6E5-44352-01	143-155-156-157-325-329-333-339-377-381-385-386
REC6E5-44365-00	6E5-44365-00	155-157-325-329-333-339-377-381-385-386

REF	R.O. / OEM	
REC6E5-44366-00	6E5-44366-00	155-156-157-325-333-339-377-381
REC6E5-45113-A2	6E5-45113-A0	253-254
REC6E5-45114-00	6E5-45114-A0	272
REC6E5-45321-00	6E5-45321-00	325-329-377-381
REC6E5-45331-00-94	6E5-45331-00-94	377-381
REC6E5-45331-00-94	6E5-45331-00-9S	325-329-391
REC6E5-45332-00-94	6E5-45332-00-94	375
REC6E5-45332-00-94	6E5-45332-00-CA	323
REC6E5-45344-00	6E5-45344-00	325-329-333-339-377-381-385
REC6E5-45371-01	6E5-45371-01	161-169-375
REC6E5-45501-01	6E5-45501-01	377-391
REC6E5-45536-00	6E5-45536-00	325-377
REC6E5-45536-00	6E5-45536-01	329
REC6E5-45551-02	6E5-45551-02	375-391
REC6E5-45560-01	6E5-45560-01	375-391
REC6E5-45567-01	6E5-45567-01	323
REC6E5-45567-01	6E5-45567-01-60	375
REC6E5-45570-00	6E5-45571-01	375-391
REC6E5-45576-00	6E5-45576-00	323-375
REC6E5-45587-01	6E5-45587-01	325-329-377
REC6E5-45611-00	6E5-45611-00	323
REC6E5-45611-01	6E5-45611-01	375-391-392
REC6E5-45631-00	6E5-45631-01	375-391-392
REC6E5-45633-01	6E5-45633-01	323-327-335-375-379-391-392
REC6E5-45634-01	6E5-45634-01	323-327-375
REC6E5-45634-01	6E5-45634-02	327
REC6E5-45641-03	6E5-45641-02	375
REC6E5-45641-03	6E5-45641-03	327-379
REC6E5-45987-00	63P-45987-00	323-327
REC6E5-45987-00	6E5-45987-01	379
REC6E5-45987-00	6E5-45987-01	375
REC6E5-45987-00	6E5-45987-01	405
REC6E5-81900-01	6E5-81900-01	84
REC6E5-85510-11	6E5-85510-10	121
REC6E5-85510-11	6E5-85510-11	121
REC6E5-85540-12	6E5-85540-10	119
REC6E5-85540-12	6E5-85540-11	119
REC6E5-85540-12	6E5-85540-12	119
REC6E5-85570-10	6E5-85570-10	105
REC6E5-85570-11	6E5-85570-11	105
REC6E5-W0001-A2	6E5-W0001-A2	251
REC6E5-W0001-A2	6N6-W0001-A3	245
REC6E5-W0001-A2	6E5-W0001-A2	254
REC6E5-W0001-F1	6E5-W0001-F1	147-374-378
REC6E5-W0001-F1	6F3-W0001-21	147
REC6E5-W0093-06	6E5-W0093-06	97-245
REC6E5-W0093-07	6E5-W0093-07	97
REC6E5-W0093-08	6E5-W0093-08	97
REC6E7-11111-01-1S	6E7-11111-01-1S	227
REC6E7-11181-00	6E7-11181-A2	248-254
REC6E7-11631-00K	6E7-11631-00	262
REC6E7-11631-00K	6E7-11631-00-97	227
REC6E7-11631-00K	6E7-11631-00-97	266
REC6E7-11635-00K	6E7-11635-00	227-262
REC6E7-11636-00K	6E7-11636-00	227-262
REC6E7-14227-00	6E7-14227-00	94
REC6E7-14385-00	6E7-14385-00	93-100
REC6E7-44366-00	6E7-44366-00	349
REC6E7-45331-00-CA	6E7-45331-00-9M	349
REC6E7-45501-00	6E7-45501-00	349
REC6E7-45501-11	6E7-45501-10	349-387-388
REC6E7-45536-00	6E7-45536-00	349
REC6E7-45551-00	6E7-45551-00	348-387-388
REC6E7-45560-01	6E7-45560-00	349
REC6E7-45560-01	6E7-45560-01	291-293-351-387-388
REC6E7-45570-00	6E7-45570-00	293
REC6E7-45570-00	6E7-45571-00	291-349-351-387-388
REC6E7-45987-00	6E7-45987-00	291-349
REC6E7-45987-00	6E7-45987-01	293-351-405
REC6E7-85570-19	6E7-85570-19-00	106
REC6E7-W0001-A1	6E7-W0001-00	249
REC6E7-W0001-A1	6E7-W0001-A1	249-254
REC6E7-W0093-01	6E7-W0093-04	95
REC6E8-14390-12	6E8-14390-12	98
REC6E9-11193-A0	6E9-11193-A0	255
REC6E9-12413-00-1S	6E9-12413-00-1S	139-235
REC6E9-12414-A1	6E9-12414-A1	138-139-235
REC6E9-14198-A0	6E9-14198-A0	275
REC6E9-41114-A0	6E9-41114-A0	142
REC6E9-82575-02	6E9-82575-00	120
REC6E9-W0093-02	6E9-W0093-02	96
REC6E9-W0093-03	6E9-W0093-03	96
REC6EE-W0078-00	6BX-WG0078-00	150
REC6EE-W0078-01	6EE-W0078-00	150
REC6EE-W0078-01	6EE-W0078-01	150
REC6EK-13761-00	6EK-13761-00	90
REC6F3-W0001-04-00	6F3-W0001-A4	251
REC6F5-11181-A2	6F5-11181-A1	235
REC6F5-11181-A2	6F5-11181-A2	248-254
REC6F5-11515-00	6F5-11515-00	233-235
REC6F5-11610-00	6F5-11610-00	263
REC6F5-11610-00	6F6-11610-00	235
REC6F5-11610-10	6F5-11610-10	263
REC6F5-11610-10	6F6-11610-10	235
REC6F5-11610-20	6F5-11610-20	263
REC6F5-11610-20	6F6-11610-20	235

REF	R.O. / OEM	
REC6F5-11633-00	6F5-11633-00	233-235-260-261-263
REC6F5-11651-00	6F5-11651-00	233-235-260-261
REC6F5-11681-00	6F5-11681-00	235-261
REC6F5-12411-03	6F5-12411-00	137
REC6F5-12411-03	6F5-12411-01	137
REC6F5-12411-03	6F5-12411-02	137-235-239
REC6F5-12411-03	6F5-12411-03	137
REC6F5-12411-03	6F5-12411-03	137
REC6F5-13621-A1	6F5-13621-A1	275
REC6F5-13645-A0	6F5-13645-A0	274
REC6F5-13646-A2	6F5-13646-A1	274
REC6F5-14198-A1	6F5-14198-A1	275
REC6F5-14323-00	6F5-14323-01	98
REC6F5-14384-00	6F5-14384-00	94
REC6F5-14390-21	6F5-14390-21	98
REC6F5-14398-00	6F5-14398-00	94
REC6F5-14483-00	6F5-14483-00	94
REC6F5-15396-01-5B	6F5-15396-01-5B	235
REC6F5-24563-00	6F5-24563-00	80-81-82
REC6F5-26311-00	6F5-26311-00	129
REC6F5-41111-01-1S	6F5-41111-01-1S	235
REC6F5-41112-A0	6F5-41112-A0	141-235
REC6F5-41113-A0-1S	6F5-41113-01-1S	235
REC6F5-41114-A0	6F5-41114-A0	142-235
REC6F5-44352-00	6F5-44352-00	143-363
REC6F5-44352-00	6F5-44352-02	156-367
REC6F5-45113-A0	6F5-45113-A0	235-255-254
REC6F5-45312-00-4D	6F5-45312-01-4D	363
REC6F5-45551-00	6F5-45551-00	363-389-390
REC6F5-45560-00	6F5-45560-00	363-389-390
REC6F5-45570-00	6F5-45570-00	363-389-390
REC6F5-85540-22	6F5-85540-22	119
REC6F5-85570-11	F5-85570-13	105
REC6F5-W0001-C0	6F5-W0001-C0	145-363
REC6F5-W0078-A0	6F5-W0078-00	151
REC6F5-W0078-A0	6F5-W0078-A0	156-363
REC6F6-11111-00-1S	6F6-11111-00-1S	235
REC6F6-11191-00-1S	6F6-11191-00-1S	235
REC6F6-11193-A1	6F6-11193-A1	235-255
REC6F6-11400-02	6F6-11400-01	235
REC6F6-11631-00K	6F6-11631-00-95	235-263
REC6F6-11635-00K	6F6-11635-00	235-263
REC6F6-11636-00K	6F6-11636-00	235-263
REC6F6-13610-00	6F6-13610-00	99
REC6F6-14301-06	6F6-14301-06	91
REC6F6-14341-00	6F6-14341-00	98
REC6F6-14385-00	6F6-14385-00	100
REC6F6-45611-00	6F6-45611-00	363-389-390
REC6F6-85530-01	6F6-85530-01	106
REC6F6-85540-01	6F6-85540-01	118
REC6F6-W0001-02	6F6-W0001-02	234-251
REC6F6-W0093-00	6F6-W0093-00	96-234
REC6F8-11181-A1	6F8-11181-A1	220-248-254
REC6FM-12411-00	6FM-	



REF	R.O. / OEM	
REC6G1-81970-62	6G1-81970-60	116
REC6G1-81970-62	6G1-81970-61	116
REC6G1-81970-62	6G1-81970-62	116
REC6G1-81970-62	6G1-81970-A0	116
REC6G1-W0001-C1	6G1-W0001-C0	144
REC6G1-W0001-C1	6N0-W0001-20	346
REC6G1-W0078-A1	6G1-W0078-00	150
REC6G1-W0078-A1	6G1-W0078-01	150
REC6G1-W0078-A1	6G1-W0078-A1	150-346
REC6G1-W0078-A1	6N0-W0078-A0	150
REC6G1-W0078-A1	6G1-W0078-A1	155
REC6G1-W0093-00	6G1-W0093-00	93-95-223
REC6G5-11181-A2	6G5-11181-A3	247-249-254
REC6G5-11193-A0	6F5-11193-A0	247
REC6G5-11193-A0	6G5-11193-A1	255
REC6G5-11382-A1	6G5-11382-A1	142-245-247
REC6G5-11411-02	6G5-11411-02	247-256
REC6G5-11631-00K	6G5-11631-00-93	265-266-267
REC6G5-11642-00K	6G5-11642-00-93	265-266-267
REC6G5-13645-A1	6G5-13645-A2	276
REC6G5-14416-A1	6G5-14416-A1	275
REC6G5-14483-01	6G5-14483-A1	276
REC6G5-41112-A1	6G5-41112-A1	142-247
REC6G5-41114-A0	6G5-41114-A0	142-247
REC6G5-41134-A1	6G5-41134-A1	270
REC6G5-41217-00	6G5-41217-01	101
REC6G5-43864-A0	6G5-43864-00	125
REC6G5-44150-02	6G5-44150-02	381
REC6G5-44323-00	6G5-44323-00	329-333-381-385
REC6G5-44323-00	6G5-44323-01	149
REC6G5-44323-00	6G5-44323-00	155-157
REC6G5-45113-A1	6G5-45113-A1	245-247
REC6G5-45113-A1	6G5-45113-A2	253-254
REC6G5-45114-A0	6G5-45114-A1	272
REC6G5-45383-01	6G5-45383-01	327-379
REC6G5-45384-00	6G5-45384-00	327-379
REC6G5-45501-21	6G5-45501-21	381-391-392
REC6G5-45536-01	6G5-45536-01	381
REC6G5-45551-00	6G5-45551-01	379-391-392
REC6G5-45560-00	6G5-45560-01	379-391-392
REC6G5-45571-00	6G5-45571-02	379-391-392
REC6G5-45576-10	6G5-45576-10	327
REC6G5-45631-00	6G5-45631-00	379-391-392
REC6G5-81960-A0	6G5-81960-A0	116
REC6G5-85510-11	6G5-85510-10	121
REC6G5-85540-12	6G5-85540-10	119
REC6G5-85540-12	6G5-85540-11	119
REC6G5-85540-12	6G5-85540-12	119
REC6G5-W0001-A3	6G5-W0001-03	252
REC6G5-W0001-A3	6G5-W0001-A3-00	247
REC6G5-W0001-A3	6G5-W0001-03	254
REC6G5-W0078-A1	6G5-W0078-00	152
REC6G5-W0078-A1	6G5-W0078-01	152
REC6G5-W0078-A1	6G5-W0078-A1	152-157-378
REC6G8-11181-A1	6G8-11181-01	181
REC6G8-11181-A1	6G8-11181-A1	215-218
REC6G8-11351-A0	6G8-11351-00	181
REC6G8-11351-A0	6G8-11351-A0	217-218
REC6G8-12414-A0	60R-E2414-A0	180
REC6G8-12414-A0	6G8-12414-00	181
REC6G8-12414-A0	6G8-12414-A0	138
REC6G8-13440-00	6G8-13440-00	83
REC6G8-13645-00	6G8-13645-00	273
REC6G8-13646-A0	6G8-13646-00	273
REC6G8-14198-A0	6G8-14198-00	273
REC6G8-15374-00	6G8-15374-00	273
REC6G8-41112-02	6G8-41112-02	140-181
REC6G8-41114-00	6G8-41114-00	140
REC6G8-45113-A1	6G8-45113-A1	271
REC6G8-46241-00	6G8-46241-00	267
REC6G8-81870-00	6G8-81870-00	120
REC6G8-81960-A1	6G8-81960-A1	117
REC6G8-W0001-A3	6G8-W0001-A3	181-216-218
REC6G9-85540-29	6G9-85540-20	117-118
REC6G9-85540-29	6G9-85540-21	117-118
REC6G9-85540-29	6G9-85540-22	117-118
REC6G9-85540-29	6G9-85540-29	117-118
REC6G9-W0001-C4	6G9-W0001-C4	144
REC6G9-W0001-C6	6G9-W0001-C6	144
REC6H0-81960-00	6H0-81960-00	116
REC6H0-W0093-00	6H0-W0093-00	97
REC6H1-11631-03K	6H1-11631-03-95	264-266
REC6H1-15359-01-94	6H1-15359-01-94	243
REC6H1-43800-17-8D	6H1-43800-13-4D	124
REC6H1-43800-17-8D	6H1-43800-14-4D	124
REC6H1-43800-17-8D	6H1-43800-15-4D	124
REC6H1-43800-17-8D	6H1-43800-16-4D	124
REC6H1-43800-17-8D	6H1-43800-17-8D	124
REC6H1-44144-00	6H1-44144-00	373
REC6H1-45214-00	6H1-45214-00	315-319
REC6H1-45215-00	6H1-45215-00	315-319
REC6H1-45611-00	6H1-45611-01-00	373-390-391
REC6H1-45631-01	6H1-45631-01-00	373-390-391
REC6H1-45634-02	6H1-45634-02	373
REC6H1-45668-00	6H1-45668-00	315-319-331-335-337-341-373-383
REC6H1-81950-01	6H1-81950-00	115
REC6H1-81950-01	6H1-81950-01	115
REC6H1-85510-00	6H1-85510-00	121
REC6H1-W0001-00-00	6H1-W0001-A1	251
REC6H1-W0093-01-00	6H1-W0093-01	97
REC6H1-W0093-01-00	6H1-W0093-01-00	243
REC6H1-W0093-10	6H1-W0093-10	97

REF	R.O. / OEM	
REC6H2-81960-10	6H2-81960-10	116
REC6H2-85540-13	6H2-85540-10	118
REC6H2-85540-13	6H2-85540-11	118
REC6H2-85540-13	6H2-85540-12	118
REC6H2-85540-13	6H2-85540-13	118
REC6H2-W0001-20	6H2-W0001-20	146
REC6H2-W0093-10	6H2-W0093-10	96-241
REC6H3-11181-A2	6H3-11181-A2	241-248-254
REC6H3-11193-A1	6H3-11193-A1	241-255
REC6H3-11631-01K	6H3-11631-01-96	241-262-266
REC6H3-11633-00	6H3-11633-00	241-261-262-264
REC6H3-11635-01K	6H3-11635-01	241-262
REC6H3-11636-01K	6H3-11636-01	241-262
REC6H3-12411-10	6H3-12411-00	137
REC6H3-12411-10	6H3-12411-01	137
REC6H3-12411-10	6H3-12411-10	137-241
REC6H3-12411-10	6H3-12411-11	137
REC6H3-12414-A1	6H3-12414-A1	203-205-207
REC6H3-13621-A1	6H3-13621-A1	138-241
REC6H3-13622-A1	6H3-13622-A1	274
REC6H3-14198-A1	6H3-14198-A1	274
REC6H3-14457-01	6H3-14457-01	94
REC6H3-14590-00	6H3-14590-01	93-98
REC6H3-41112-A0	6H3-41112-A0	141-241
REC6H3-41114-A0	6H3-41114-A0	141-241
REC6H3-41217-00	6H3-41217-00	101
REC6H3-44311-00	6H3-44311-00	148
REC6H3-44315-00	6H3-44315-00	154-156
REC6H3-44323-00	6H3-44323-00-00	149-154-156
REC6H3-44352-00	6H3-44352-00	369
REC6H3-44352-00	6H3-44352-00	143-154-156-313-317
REC6H3-45113-00	6H3-45113-00	241
REC6H3-45113-A0	6H3-45113-A0	253-254
REC6H3-45114-A1	6H3-45114-A1	271
REC6H3-45123-00	6H3-45123-00	269
REC6H3-45127-00	6H3-45127-00	269
REC6H3-82510-03	6H3-82510-00	114
REC6H3-82510-03	6H3-82510-01	114
REC6H3-82510-03	6H3-82510-02	114
REC6H3-82510-03	6H3-82510-03	114
REC6H3-85520-00	6H3-85520-00	107
REC6H3-85540-11	6H3-85540-10	118
REC6H3-85540-11	6H3-85540-11	118
REC6H3-85540-12	6H3-85540-12	118
REC6H3-85540-13	6H3-85540-10	118
REC6H3-85540-13	6H3-85540-11	118
REC6H3-85540-13	6H3-85540-12	118
REC6H3-85540-13	6H3-85540-13	118
REC6H3-85570-10	6H3-85570-10	104
REC6H3-W0001-02	6H3-W0001-02	241-250-254
REC6H3-W0001-22	6H3-W0001-22	145
REC6H3-W0078-02	6H3-W0078-00	68-69-152-154-156
REC6H3-W0093-02	6H3-W0093-02	93-97
REC6H4-11181-00	6H4-11181-A2	248-254
REC6H4-11193-A1	6H4-11193-00	255
REC6H4-11610-00-00	6H4-11610-00	264-266
REC6H4-11631-00K	6H4-11631-00-96	264-266
REC6H4-11631-01K	6H4-11631-01-95	237-263-266
REC6H4-11634-01	6H4-11634-01	237-263-264
REC6H4-11635-00K	6H4-11635-00	264
REC6H4-11635-01K	6H4-11635-01	237-263
REC6H4-11636-01K	6H4-11636-00	264
REC6H4-11636-01K	6H4-11636-01	237-263
REC6H4-11641-00	6H4-11641-00	237-261
REC6H4-14198-01	6H4-14198-01	274
REC6H4-14198-09	6H4-14198-00	274
REC6H4-14984-00	6H4-14984-00	94
REC6H4-14985-01	650-14385-00	100
REC6H4-14985-01	6H4-14985-00	100
REC6H4-14985-01	6H4-14985-01	100
REC6H4-14985-01	6M6-14385-00	100
REC6H4-14985-01	6H4-15369-A1	237
REC6H4-41112-A0	6H4-41112-A0	141-237
REC6H4-41114-A0	6H4-41114-A0	141-237
REC6H4-41134-A0	6H4-41134-A0	269
REC6H4-44352-02	6H4-44352-00	309
REC6H4-44352-02	6H4-44352-02	143-297-301-305-355-357-359-361
REC6H4-44352-02	6H4-44352-02	154-155-156
REC6H4-45113-00	6H4-45113-00	237
REC6H4-45113-00	6H4-45113-A0	253-254
REC6H4-45551-00	6H4-45551-00	359-389-390
REC6H4-45560-00	6H4-45560-00	359-389-390
REC6H4-45570-00	6H4-45571-00	359-389-390
REC6H4-45631-00	6H4-45631-00	389-390
REC6H4-W0001-04	6H4-W0001-04	237-250
REC6H4-W0001-21	6H4-W0001-21	359
REC6H4-W0001-A1	6H4-W0001-01	250-254
REC6H4-W0078-00	6H4-W0078-00	151
REC6H4-W0078-00	6H4-W0078-A0	359
REC6H4-W0078-00	6H4-W0078-A0	155-156
REC6H4-W0093-01-00	6H4-W0093-01	96
REC6H4-W0093-03	6H4-W0093-03	96-237
REC6H9-45551-00	6H9-45551-00	365-389
REC6J1-11610-00	6J1-11610-00	221
REC6J8-11181-A2	6J8-11181-A1	231
REC6J8-11181-A2	6J8-11181-A2	248
REC6J8-11181-A2	6J8-11181-A2	254
REC6J8-11631-02	6J8-11631-02-97	231-263-266
REC6J8-13411-00	6J8-13411-00	83

REF	R.O. / OEM	
REC6J8-24471-00	6J8-24471-00	87
REC6J8-45113-00	6J8-45113-A0	231-253-254
REC6J8-85540-H2	6J8-85540-H2	120
REC6J8-W0001-21	6J8-W0001-21	145-357
REC6J8-W0078-A2	6J8-W0078-A1	150-151
REC6J8-W0078-A2	6J8-W0078-A2	155-357
REC6J9-45332-00-CA	6J9-45332-00-CA	327-379-391-392
REC6J9-45611-00	6J9-45611-01	327-379-391-392
REC6K1-82510-07	6K1-82510-06	113
REC6K1-82570-13	6K1-82570-13	128
REC6K4-11422-00	6K4-11422-00	256
REC6K4-11432-00	6K4-11432-00	256
REC6K4-11651-00	6K4-11651-00	260
REC6K5-11601-02	6K5-11601-02	241-262-264-266
REC6K5-11601-12	6K5-11601-12	241-262-264
REC6K5-11601-22	6K5-11601-22	241-262-264
REC6K5-11631-03K-95	6K5-11631-03-95	264-266
REC6K5-11635-03K	6K5-11635-03	264
REC6K5-11636-03K	6K5-11636-03	264
REC6K5-11681-00	6K5-11681-00	261
REC6K5-14301-03 +	6K5-14301-03 +	92-93
REC6K5-14302-03 +	6K5-14302-03 +	92-93
REC6K5-14303-03	6K5-14303-03	388-390
REC6K5-45551-00	6K5-45551-00	388-390
REC6K5-45560-00	6K5-45560-00	388-390
REC6K5-45570-00	6K5-45570-00	390
REC6K5-W0001-02	6K5-W0001-02	251
REC6K5-W0078-01	6K5-W0078-01	152-156
REC6K7-11633-00	6K7-11633-00	261-265
REC6K7-13645-A2	6K7-13645-A2	276
REC6K7-13646-A2	6K7-13646-A2	276
REC6K7-W0093-09	6K7-W0093-09	97
REC6K8-41122-A1	6K8-41122-A1	141-229
REC6K8-41124-A1	6K8-41124-A1	141-229
REC6L2-11181-A1	6L2-11181-A3	248-254
REC6L2-11193-A1	6L2-11193-A1	255
REC6L2-13621-00	6L2-13621-00	274
REC6L2-14384-00-00	6L2-14384-00	94
REC6L2-14385-00	6L2-14385-00	93-100
REC6L2-14399-00	6L2-14399-00	94
REC6L2-26301-00		

REF	R.O. / OEM	
REC6P3-WS24A-00	6P3-WS24A-00	81
REC6P3-WS24A-00	6P3-WS24A-01	81
REC6P3-WS24A-00	6P3-WS24A-01	71-72-73-81
REC6R3-11411-00	6R3-11411-00	256
REC6R3-81960-10	6R3-81960-10	116
REC6R3-82563-01	6R3-82563-00	122
REC6R3-82563-01	6R3-82563-01	122
REC6R3-85570-01	6R3-85570-01104	104
REC6R3-W0001-03	6R3-W0001-A3	252
REC6R4-13200-02	6R4-13200-00	84
REC6R4-13200-02	6R4-13200-01	84
REC6R4-13200-02	6R4-13200-02	84
REC6R5-11603-00	6R5-11603-00	265-266-267
REC6R5-11631-01K	6R5-11631-11-93	265-266-267
REC6R5-11631-11K	6R5-11631-11-93	245
REC6R5-11631-11K	6R5-11631-11-93	265
REC6R5-11631-11K	6R5-11631-11-93	266-267
REC6R5-11633-00	6R5-11633-10	245-247-261-265
REC6R5-11634-00	6R5-11634-00	265
REC6R5-11634-00	6R5-11634-10	245-247-265
REC6R5-11642-01K	6R5-11642-11-93	245-265-266-267
REC6R5-11642-11K	6R5-11642-11-93	265-266-267
REC6R5-11650-10	6R5-11650-10	247
REC6R5-11650-10	6R5-11650-00	245
REC6R6-W0001-02-00	6R6-W0001-02	250-254
REC6R7-11181-A0	6R7-11181-A1	248-254
REC6S1-41136-00	6S1-41136-00	270
REC6S1-85885-00	6S1-85885-00	90-102
REC6X2-85885-10	6X2-85885-00	103
REC6X2-85885-10	6X2-85885-10	103
REC703-48205-16	703-48205-10	126
REC703-48205-16	703-48205-11	126
REC703-48205-16	703-48205-12	126
REC703-48205-16	703-48205-13	126
REC703-48205-16	703-48205-14	126
REC703-48205-16	703-48205-15	126
REC703-48205-16	703-48205-16	126
REC703-48205-16	703-48205-17	126
REC703-48205-16	703-48205-18	126
REC703-48205-16	703-48205-1A	126
REC703-48205-16	703-48205-1B	126
REC703-48205-16	703-48205-20	126
REC703-48205-16	703-48205-21	126
REC703-48230-14	703-48230-10	126
REC703-48230-14	703-48230-11	126
REC703-48230-14	703-48230-12	126
REC703-48230-14	703-48230-13	126
REC703-48230-14	703-48230-14	126
REC703-48230-14	703-48230-15	126
REC703-48230-14	703-48230-16	126
REC703-48230-14	703-48230-17	126
REC703-48230-14	703-48230-18	126
REC703-48230-14	703-48230-1A	126
REC703-48230-14	703-48230-20	126
REC703-48230-14	703-48230-21	126
REC703-48230-14	703-48230-23	126
REC703-82510-44	703-82510-43	114
REC704-48205-R0	704-48205-11	127
REC704-48205-R0	704-48205-12	127
REC704-48205-R0	704-48205-13	127
REC704-48205-R0	704-48205-14	127
REC704-48205-R0	704-48205-15	127
REC704-48205-R0	704-48205-B0	127
REC704-48205-R0	704-48205-B1	127
REC704-48205-R0	704-48205-P0	127
REC704-48205-R0	704-48205-P1	127
REC704-48207-R0	704-48207-20	127
REC704-48207-R0	704-48207-21	127
REC704-48207-R0	704-48207-22	127
REC704-48207-R0	704-48207-30	127
REC704-48207-R0	704-48207-31	127
REC704-48207-R0	704-48207-39	127
REC704-48207-R0	704-48207-P1	127
REC704-48207-R0	704-48207-R0	127
REC704-82570-12	6E5-82570-05	128
REC704-82570-12	704-82570-08	128
REC704-82570-12	704-82570-10	128
REC704-82570-12	704-82570-11	128
REC704-82570-12	704-82570-12	128
REC70720		79
REC84419M	696-W0093-01	96
REC84419M	696-W0093-02	96
REC8542561	65W-W0093-02	95-190-197
REC855686		77
REC866169T01	6C5-13907-00	86
REC881346T	68V-81960-00	117
REC881346T	6D3-81960-00	117
REC89-825096T01	66G1-81941-10	114
REC89-825096T01	6E5-81950-01	114
REC89-825096T01	6G1-81940-00	114
REC89-825096T01	6G1-81941-10	110
REC90101-06M56	90101-06M56	353
REC90101-06M56	97095-06030	209
REC90105-06M01	90105-06M01	363
REC90109-08022	90109-08022	239-243-247
REC90109-08M71	90109-08M71	245
REC90119-06M10	90119-06M10	325-329-333-377-385
REC90119-08M13	90119-08M13	321-357-371-317-325-329-333-335-339-341-377-381-385-386
REC90119-08M14	90119-08M14	

REF	R.O. / OEM	
REC90119-08M15	90119-08M15	301-305-309-13-361
REC90119-08M21	90119-08M21	231
REC90119-08M33	90119-08M33	317
REC90119-08M87	90119-08M87	321
REC90149-06M00	90149-06M00	365
REC90151-05M00	90152-05000	315-319
REC90170-12138	90170-012138	365
REC90170-12138	90170-12138	299-303-307-311-359-361-369
REC90170-16M01	90170-16M01	315-319-323-327-371-375-379
REC90170-16M01	90170-16M01-00	373
REC90170-16M19	90170-16M19	331-335-337-383
REC90171-10M01	90171-10M01	289-291-293-405-351
REC90171-14013-00	90171-14013	295-353-355-357-405
REC90171-16011	90171-16011	299-303-307-311-315-319-359-361-365-369-371
REC90171-16011	90171-16011	405
REC90171-16011	90171-16011-00	373
REC90171-18M04	90171-18M04	323-327-331-335-337-341-375-379-383-405
REC90179-08M06	90179-08M06	291-293-348-351
REC90179-09M02	90179-09M02	353
REC90179-10M14	90179-10M14	295-355-357-315-319-331-335-337-341-373-383
REC90183-02M03	90183-02M03	331-335-337-341-383
REC90201-02M00	90201-02M00	341-383
REC90201-10M01	90201-10M01	289-405
REC90201-12565	90201-12565	225-260
REC90201-14377	90201-14377	227-260
REC90201-16M00	90201-16M00	331-335-337-383
REC90201-17682	90201-17682	291-293-349-351
REC90201-17M00	90201-17M00-00	373
REC90201-20417	90201-20417	233-235-239-241-243-260-261-353-355-357
REC90201-20M27	90201-20M27	229-260
REC90201-21M75	90201-21M75	245-247-261-299-303-307-359-361-365-369
REC90201-22429	90201-22429	325-329-333-377-381-385-245-247-261
REC90201-22M01	90201-22M01	323-327-375-379
REC90201-23M01	90201-23M01	331-383
REC90201-30M92	90201-30M92	339
REC90201-31M00	90201-31M00	227
REC90201-42014	90201-42014	339
REC90201-46M29	90201-46M29	227
REC90206-22M19	90206-22M19	325-329-333-377-381-385-221-223-225-260
REC90209-18112	90209-18112	227-260
REC90209-20159	90209-20M23	229-260-261
REC90209-24M03	90209-24M03	233-235-260-261
REC90209-27M07	90209-27M07	261
REC90209-27M11	90209-27M11	261
REC90214-48M03	90214-48M03	365-369
REC90250-03M10	90250-03M10	291-293-295-349-351-353-355-357
REC90250-05010	90250-05010	347
REC90250-05036	90250-05036	345
REC90250-05046	90250-05046	299-303-307-311-359-361-363-365-369-315-319-371
REC90250-06023	90250-06023	373
REC90250-07M02	90250-07M02	323-327-335-375-379
REC90250-07M02	90250-07M02-00	154-155-156-309-313-346-347-349-357-359
REC90250-08M07	90250-08M07	154-156-301-305-317-355-361-369-335
REC90280-03024	90280-03024	156-363-367-154-155-156-321-371
REC90280-03M03	90280-03M03	373
REC90280-04002	90280-04002	155-156-157-325-329-333-339-377-381-385-386
REC90280-04M00	90280-04M00	229
REC90280-04M04	90280-04M04-00	365
REC90280-04M04	90280-04M04-00	
REC90280-04M05	90280-04M05	
REC90280-05049	90280-05049	
REC90282-04010	90282-04010	

REF	R.O. / OEM	
REC90282-04010	90282-04010	315-319-323-353-357-359-369-371-373-375
REC90282-04M00	90282-04M00	327
REC90340-08002	6E0-45316-09	346
REC90340-08002	90340-08002	283-285-287-289-291-282-299-303-307-311-315-319-323-327-331-335-337-341-345-350-353-357-361-363-369-370-373-379-383
REC90340-08002	90340-08014	348-359
REC90340-08002	90340-08M04	295-343-347-365-375
REC90381-20001	90381-20001	133
REC90386-18M63	90386-18M63	133
REC90386-22M13	90386-22M13	133
REC90386-22M98	90386-22M98	133
REC90386-25M31	90386-25M31	133
REC90386-30M77	90386-30M77	133
REC90386-38M89	90386-38M89	133
REC90387-32002	90387-32002	229
REC90389-22M01	90389-22M01	299-303-307-311-361-365-405
REC90389-25M00	90389-25M00	315-319-371-405
REC90430-06M03	90430-06M03	209-211-213-214-347-363-365
REC90430-08020	90430-08003	292-303-307-311-315-323-283-285-287-289-291-299-327-331-335-337-341-343-345-346-347-348-350-353-355-357-359-361-363-365-369-370-375-379-383-386
REC90430-08020	90430-08020	295
REC90430-08020	90430-08020	64-65-66-67-68-69-70-71-72-73
REC90430-08020	90430-08020-00	373
REC90430-12072	90430-12072	301-305-309-361-367-371
REC90430-12072	90430-12072-00	373
REC90480-18065	90480-18065	235-239
REC90480-20M05	90480-20M05	139-209-211-243-245-247-331-335-337-341-383
REC90501-10M77	90501-10M77	329-333-339-381-385
REC90501-11M10-00	90501-11M10	315-319-373
REC90501-12M48	90501-12M48	235
REC90501-14M02	90501-14M02	369-371
REC90501-16233	90501-16233	359-365
REC90501-16M01	90501-16M01	139-209-211-243-245-247
REC90501-16M11	90501-16M11	323-327-375-379
REC90501-16M37	90501-16M37	339
REC90501-450A2	90501-450A2	78
REC90794-46866	907-94469-05	78
REC90794-46866	907-94469-13	78
REC91490-30025	91490-30020	289-291-293-351
REC91490-30025	91490-30025	64-65-67-68-69-299-303-307-311-315-357-361-365-405
REC91490-30030	91490-30030	353-359-405
REC91490-30040	91490-30040	343
REC91490-40030	91490-40025	319-369-371-68-69-70-71-72-73-323-327-331-335-337-341-375-379-383-405
REC91490-40030	91490-40030-00	373
REC92990-16200	92990-16200	359-369-405
REC92990-18200	92990-18200	323-327-331-335-337-375-379-405
REC93101-10M14	93101-10M14	345
REC93101-10M25	93101-10M25	221
REC93101-11M23	93101-11M23	289-346
REC93101-12M70	93101-12M70	341
REC93101-13018	93101-13018	227
REC93101-13M12	93101-13M12	287-345
REC93101-13M27	93101-13M27	270
REC93101-14M01	93101-14M01	225
REC93101-15074	93101-15074	289-346-347
REC93101-16001	93101-16001	229-233
REC93101-17054	93101-17054	291-293-349-351
REC93101-18050	93101-18050	347
REC93101-20048	93101-20011	292
REC93101-20048	93101-20048	291-349-351-363

YAMAHA

RECAMBIOS MARINOS



REF	R.O. / OEM	
REC93101-20M07	93101-20M07	295-353-355-357
REC93101-20M29	93101-20M29	221-225
REC93101-20M34	93101-20M34	223
REC93101-22067	93101-22067	353-355-359-365-367-369
REC93101-22M00	93101-22067	297
REC93101-22M00	93101-22M00	299-303-307-311-361-363
REC93101-22M15	93101-22M15	245-247
REC93101-22M60	93101-22M60	301-305-361
REC93101-23070	93101-23070	317-357-359-369
REC93101-25018	93101-250-18	227
REC93101-25M03	93101-25M03	315-319-321-371
REC93101-25M03	93101-25M03-00	373
REC93101-25M35	93101-25M28	231
REC93101-25M57	93101-25M57	309-313
REC93101-28M16	93101-28M16	325-329-333-335-339-377-381-385-386
REC93101-30002	93101-300002	335-337
REC93101-30M17	93101-30M17	323-327-331-375-379-383
REC93101-30M33	93101-30M33	235
REC93102-15M32	93102-15M32	220
REC93102-20M25	93102-20M25	223-225
REC93102-23096	93102-23096	237
REC93102-25008	93102-25008	229
REC93102-25M28	93102-25M28	237
REC93102-25M48	93102-25M48	227
REC93102-26M27	93102-26M27	231
REC93102-28135	93102-28135	239
REC93102-30M05	93102-30M05	243
REC93102-30M23	93102-30M23	241
REC93102-30M56	93102-30M56	233
REC93102-32M07	93102-32M07	229-239
REC93102-35M13	93102-35M13	245-247
REC93102-35M18	93102-35M18	235
REC93102-36M02	93102-36M02	243
REC93102-36M24	93102-36M24	241
REC93102-38008	93102-38008	211-213
REC93102-38008	93102-38M59	209
REC93102-40M14	93102-40M14	245-247
REC93102-48009	93102-48009	209
REC93102-60004	93102-60004	211
REC93102-63004	93102-63008	213
REC93103-10052	93103-10052	343
REC93103-11051	93103-11051	343
REC93104-16M01	93104-16M01	235-237
REC93104-16M01	93104-16M04	231
REC93104-18049	93104-18049	239
REC93104-20M02	93104-20M02	243
REC93104-22M07	93104-22M07	335
REC93106-09014	93106-09014	305-309-313-317-321-325-329-333-335-339-369-371-377-381-385
REC93106-09014	93106-09014-00	373
REC93106-18M01	93106-18M01	241
REC93109-44M00	93109-44M00	132
REC93110-23M00	93110-23M00	227
REC93210-06ME6	93210-06ME6	289-291-292-297-301-351-361
REC93210-07540	93210-07003	329
REC93210-19MJ1	93210-19MJ1	211-213
REC93210-22M02	93210-22M02	235
REC93210-25552	93210-25552	211-213
REC93210-32738	93210-32738	65-66-68-69
REC93210-33MG4	93210-33MG4	301-305-309-313-361
REC93210-37160	93210-37160	325-329-333-335-339-341-377-381
REC93210-37M67	93210-37M67	385-386
REC93210-41042	93210-41042	357-359-367-369
REC93210-42101	93210-42101	343
REC93210-42159	93210-42159	223-225-231-239
REC93210-42M70	93210-42M70	225
REC93210-44398	93210-44398	154-155-289-291
REC93210-45161	93210-45161	155
REC93210-46044	93210-46044	317-321-371
REC93210-46044	93210-46044-00	373
REC93210-46M16	93210-46M16	227-229-241-243
REC93210-48214	93210-48214	287-341-345
REC93210-48MG8	93210-48MG8	301-309-361
REC93210-49046	93210-49046	154-289-293-317-321-346-359-369-371
REC93210-49046	93210-49046-00	373
REC93210-53M08	93210-53M08	289-346
REC93210-54534	93210-54534	333-339-385
REC93210-54534	93210-55M14	325-329-377-381
REC93210-54M54	93210-54M54	223
REC93210-57M00	93210-57M00	363
REC93210-57M09	93210-57M09	291-293-349-351
REC93210-58677	93210-58144	325-329-377-381
REC93210-58677	93210-58677	347

REF	R.O. / OEM	
REC93210-58M21	93210-58M21	229-237
REC93210-59MG7	93210-59MG7	154-156-301-305-309-313-361
REC93210-60MA3	93210-60MA3	357
REC93210-62269	93210-62269	239-243
REC93210-64ME7	93210-64ME7	295-355
REC93210-65752-00	93210-64488	333-335
REC93210-65M50	93210-65M50	233-235-241-295-355
REC93210-66M98	93210-66M98	359-365-369
REC93210-69MG6	93210-69MG6	299-303-307-311-341-361
REC93210-74M35	93210-74M35	245-247
REC93210-74MG5	93210-74MG5	299-303-311-361
REC93210-85M97	93210-85M97	371
REC93210-85M97	93210-85M97-00	373
REC93210-86M38	93210-86M38	155-156-157-325-329-333-339-377-381-385-386
REC93210-86M39	93210-86M39	315-319-323-375
REC93210-94003	93210-94003	335-341
REC93210-97M55	93210-97M55	327-379
REC93211-04001	93211-04001	245-247
REC93211-04384	93211-04384	331-337-383
REC93304-205U0	93304-205U0	257
REC93306-001U1	93306-001U1	299-303-307-311-361-394-395-396
REC93306-00501	93306-00501	291-293-349-351-393-394
REC93306-00519	93306-00519	347-393
REC93306-00612	93306-00612	353-355-357-394-395
REC93306-00702	93306-00702	359-365-369-394-395-396
REC93306-204U0	93306-204U0	221-223
REC93306-204U0	93306-240U0	225-257
REC93306-204Y7	93306-20401	363
REC93306-205U2	93306-205U7	257
REC93306-205U7	93306-205U7	227-257
REC93306-206U5	93306-206U5	243-258
REC93306-207U0	93306-207U0	315-319-371-395-396-397
REC93306-207U0	93306-207U0-00	373
REC93306-208U0	93306-208U0	245-247-258-259-323-375-393-397
REC93306-209U0	93306-209U0	397-398-399-400
REC93306-209U1	93306-209U1	259
REC93306-210U0	93306-210U0	331-337-383-399-400
REC93306-304U0	93306-304U0	257
REC93306-30510	93306-30510	257-258
REC93306-305U3	93306-305U3	229-231-257-258
REC93306-305U8	93306-305-U8	237-258
REC93306-306V1	93306-303V1	235
REC93306-306V1	93306-306V1	241-257-258
REC93306-306V5	93306-306V5	233-258
REC93306-307U0	93306-307U0	233-235-258
REC93310-112V0	93310-112V0	221-223-257-262
REC93310-32337	93310-323V6	245
REC93310-32337	93603-21111	265
REC93310-32337	93310-32337	247-258-259-265
REC93310-32668	93310-32668	247
REC93310-326V4	93310-326V4	259
REC93310-418U0	93310-418U0	225-257
REC93310-418V1	93310-418V1	221-223-257
REC93310-522W0	93310-522W0	257-258
REC93310-527W1	93310-527W1	258
REC93310-620V5	93310-620V5	227-257
REC93310-624U5	93310-624U5	229-257-258
REC93310-636U4	93310-636U4	243-258
REC93310-727U0	93310-727U0	233-258
REC93310-727V7	93310-727V7	235-258
REC93310-730V6	93310-730V6	258
REC93310-730V8	93310-730V8	239-243-258
REC93310-835U8	93310-835U8	243-258
REC93310-836U0	93310-836U0	258-259
REC93310-836V2	93310-836V2	245-247-258-259
REC93310-954U1	93310-954U1	245-247-258-259
REC93310-954V3	93310-954V3	258-259
REC93310-959U0	93310-959U0	247
REC93311-632U1	93311-632U1	239-258
REC93311-632U7	93311-632U7	231-257
REC93311-632V4	93311-632V4	257-258
REC93311-636U6	93311-636U6	241-257-258
REC93311-83280	93311-83280	331-335-337-383-399-400
REC93311-832U4	93311-832U4	239-258
REC93311-858U4	93311-858U4	335
REC93311-928U5	93311-928U5	329-381-397-398-399-400
REC93311-940U3	93311-940U3	245-247-258-259
REC93311-940V0	93311-940V0	247
REC93315-017U4	93315-017U4	353-394-395
REC93315-217U0	93315-217U0	363-395

REF	R.O. / OEM	
REC93315-22004	93315-22004	295-353-355-357-394-395
REC93315-220V7	93315-220V7	355-357-394-395
REC93315-314V8	93315-314V8	291-292-351-393-394
REC93315-317U2	93315-317U2	291-293-349-351-393-394
REC93315-32224	93315-32224	301-305-309-313-359-361-367-369-394-395-396
REC93315-324U1	93315-324U1	363-395
REC93315-325V1	93315-325V1	371-394-395-396
REC93315-325V1	93315-325V1-00	373
REC93315-425U7	93315-425U7	323-375-396-397
REC93315-425V3	93315-425V3	327-379-397-398-399-400
REC93315-43061	93315-43061	327-331-335-379-383-397-398-399-400
REC93315-430U8	93315-430U8	323-375-396-397-398-399-400
REC93315-430V5	93315-430V5	396-397-398-399-400
REC93315-628U9	93315-628U9	325-377-396-397-398
REC93317-22204	93317-22204	299-303-307-311-359-361-365-369-394-395-396
REC93317-322V0	93317-322V0	315-319-396-397
REC93317-325U0	93317-325U0	315-319-371-396-397
REC93317-325U0	93317-325U0-00	373
REC93317-330U2	93317-330U2	325-329-333-339-377-381-385-396-397-398-399-400
REC93332-00001	93332-00001	301-305-309-313-357-361-369-394-395-396
REC93332-00003	93332-00003	291-293-295-349-351-353-355-393-394-395
REC93332-00005	93332-00005	395
REC93332-00023	93332-00023	394-395-396
REC93332-00048	93332-00048	327-331-397-398-399-400
REC93332-000A5	93332-000A5	335
REC93332-000U0	93332-000U0	363-395
REC93332-000U3	93332-000U3	317-321-371-396-397
REC93332-000U3	93332-000U3-00	373
REC93332-000U5	93332-000U5	396
REC93332-000U7	93332-000U7	323-375-396-397
REC93332-000U7	93332-000U7	233-235-258
REC93332-000V3	93332-000V3	327-379-397-398-399-400
REC93332-000W1	93332-000W1	331-337-383-399-400
REC93332-000W5	93332-000W5	355-394-395
REC93332-000W7	93332-000W7	371-394-395-396
REC93332-000W7-00	93332-000W7-00	373
REC93340-670U1	93340-670U1	335-341
REC93341-214U1	93314-314V8	291
REC93341-214U1	93341-214U1	348-393-394
REC93341-41414	93341-41414	351-393-394
REC93341-93020	93341-93020	333-385
REC93341-93020	93341-930U9	339
REC93341-930V2	93341-930V2	325-329-377-381-396-397-398-399-400
REC93342-624U0	93342-624U0	363
REC93390-000U0	93390-000U0	363-395
REC93390-000U2	93390-000U2	397-398-399
REC93399-99951	93399-99951	229-257
REC93440-52009	93440-52008	227
REC93440-68M03	93440-68M03	233-235
REC93450-13022	93450-13022	221-223-225-262
REC93450-15023	93450-15023	227-262
REC93501-04011	93501-04011	331-335-337-341-383
REC93503-16003	93503-16003	315-319-323-327-373-375-379
REC93507-32031	93507-32009	323-327
REC93507-32031	93507-32031	375-379
REC93511-32027	93511-32017	327
REC93511-32027	93511-32027	323-375-379
REC93602-14104	93602-14104	227-257-262
REC93602-14118	93602-14118	225-257-262
REC93602-18M12	93602-18M12	229
REC93602-20M02	93602-20M02	229-237-257-258-263-264
REC93603-1		

REF	R.O. / OEM	
REC93603-21111	93603-21111	233-235-239-243-258-259-263-264-265
REC93606-12019	93606-12019	205
REC93606-12019	93606-11M24	297
		187-195-201-203-207-209-211-213-214-221-227-229-231-237-299-303-307-311-315-319-325-329-333-335-339-341-349-367-371-377-381-385
REC93606-12019	93606-42019	386
REC93608-12M05	93608-12M05	323-331-337-341-383
REC95380-06700	95380-06700	301-361
REC97075-10040	97075-10040	299-303-307-311-319-369-370
REC97080-08045	97080-08045	289-291-351
REC97095-06040	97095-06040	347-355
REC97095-06045	97095-06045	211-287-346
REC97095-08045	97095-08045	293-363-367-369
REC97095-08045	97395-08045	359
REC97095-08055	97095-08055	363-367-369
REC97095-08055	97395-08055	359
REC97395-08070	97395-08070-00	373
REC99001-06600	99001-06600	287-346
		305-309-313-317-321-325-329-333-335-339-369-371-377-381-385
REC99001-08600-00	99001-08600	337-383
REC99590-10114	99590-10114	134
REC99999-02808	99999-02808	209
RECK0A-A3721-00	K0A-A3721-00	209
RECK0A-A3722-00	K0A-A3722-00	209
RECKITF100D		70
RECKITF100F		70
RECKITF115A		70
RECKITF115B		71
RECKITF150CR		71
RECKITF150G		72
RECKITF150RR		71
RECKITF15C		65
RECKITF2.5A		64
RECKITF2.5B		64
RECKITF200A		72
RECKITF200C		72
RECKITF20A		65
RECKITF20B		65
RECKITF225B		72
RECKITF225C		73
RECKITF250D		73
RECKITF25A		66
RECKITF25D		66
RECKITF25G		66
RECKITF300A		73
RECKITF30A		67
RECKITF30B		67
RECKITF350A		73
RECKITF40B		67
RECKITF4A		64
RECKITF50A		67
RECKITF50F		68
RECKITF5A		64
RECKITF60A		69
RECKITF6A		64
RECKITF6C		64
RECKITF70A		69
RECKITF80A		69
RECKITF80B		70
RECKITF9.9C		65
RECKITF25B		66
RECKITF25F		66
RECKITF50B		68
RECKITF50C		68
RECKITF50G		68
RECKITF60B		69
RECKITF8D		65
REC26-13440-00	N26-13440-00	83-214
REC26-13440-00	N26-13440-02	73-83
RECOBBRACKET		77
RECOBELEMENT		78
RECOBFILALU		78
RECOBFILTER		78
RECPIN4		125
RECPIN4.5		125
RECPIN6		125
RECTOOLTRIM1		125
RECTOOLTRIM2		125
RECTOOLTRIM3		125
RECTOOLTRIMKIT		125
RECYS-225-15		78
RM35-802893Q		78
RM92-858026QB1U6	92-858026QB1	84
RM92-858027QB1U3	92-858027QB1	84
RM92-8M0086220U6	92-8M0086220	84
RM92-8M0086221U3	92-8M0086221	84

**S**  
SIE18-8013

REF	R.O. / OEM	
SIE18-8015		74
SOL2011-083-08P		402
SOL3011-073-05S	6L5-45949-00-EL	402
SOL3011-075-07S	6E0-45943-01-EL	402
SOL3011-085-07	6G1-45947-00-EL	402
SOL3011-085-08	6G1-45943-00-EL	402
SOL3011-085-09	6G1-45941-00-EL	402
SOL3011-090-07-P	647-45943-00-EL	402
SOL3111-093-07		402
SOL3111-093-08	683-45947-00-EL	402
SOL3111-093-09	683-45945-00-EL	402
SOL3111-093-10	683-45942-00-EL	402
SOL3111-093-11	683-45943-00-EL	402
SOL3111-093-12	683-45941-00-00	402
SOL3211-099-09	664-45941-01-EL	402
SOL3211-099-10	664-45945-00-EL	402
SOL3211-099-11	664-45947-01-EL	402
SOL3211-099-12	664-45954-00-EL	402
SOL3211-099-13	664-45949-02-EL	402
SOL3231-101-13	MAR-6YT30-02-12	402
SOL3231-103-12	664-45970-00-98	402
SOL3231-105-11	664-45972-00-98	402
SOL3231-108-10		402
SOL3311-110-15	663-45943-02-EL	402
SOL3311-110-16	663-45949-01-EL	402
SOL3311-110-17	663-45941-01-EL	402
SOL3311-111-13	663-45945-02-EL	402
SOL3311-111-14	663-45958-01-EL	402
SOL3311-114-12	663-45952-02-EL	402
SOL3311-115-10-P		402
SOL3311-115-11-P		402
SOL3311-115-12-P		402
SOL3311-116-11	663-45947-02-EL	402
SOL3311-121-09	663-45956-01-EL	402
SOL3331-111-13	663-45945-02-EL	402
SOL3331-111-14	663-45958-01-EL	402
SOL3331-114-12	663-45970-60-98	402
SOL3331-116-11	663-45972-60-98	402
SOL3331-119-10	663-45954-01-EL	402
SOL3411-130-19	6E5-45941-00-EL	402
SOL3411-130-21	6E5-45943-00-EL	402
SOL3411-133-17	6E5-45945-00-EL	402
SOL3411-135-15	6E5-45947-00-EL	402
SOL3411-138-13	6E5-45949-00-EL	402
SOL3411-140-11	6E5-45954-00-EL	402
SOL3412-133-17		402
SOL3412-135-15		402
SOL3412-138-13		402
SOL3413-125-19	6E5-45941-00-EL	402
SOL3413-125-21	6E5-45943-00-EL	402
SOL3413-128-17	6E5-45945-00-EL	402
SOL3413-130-15	6E5-45947-00-EL	402
SOL3413-133-13	6E5-45949-00-EL	402
SOL3431-130-19	688-45970-03-98	402
SOL3431-130-21	688-45972-02-98	402
SOL3431-133-17	688-45930-02-98	402
SOL3431-135-15	688-45978-60-98	402
SOL3432-130-19		402
SOL3432-133-17		402
SOL3511-142-23	6G5-45949-00-98	403
SOL3511-143-21	6G5-45949-00-98	403
SOL3511-145-19	6G5-45945-01-98	403
SOL3511-148-17	6G5-45947-01-98	403
SOL3511-150-15	6G5-45941-00-98	403
SOL3512-142-23	6G5-45949-00-98	403
SOL3512-143-21		403
SOL3512-145-19	6K1-45945-01-98	403
SOL3512-148-17	6K1-45947-00-98	403
SOL3512-150-15	6G5-45952-00-98	403
SOL3513-140-21	6G5-45949-00-98	403
SOL3513-143-19	6G5-45945-01-98	403
SOL3513-145-17	6G5-45947-01-98	403
SOL3513-148-15	6G5-45941-00-98	403
SOL3514-140-21		403
SOL3514-143-19	6K1-45945-01-98	403
SOL3514-145-17	6K1-45947-00-98	403
SOL3514-148-15	6G5-45952-00-98	403
SOL3531-140-19	6G5-45974-03-98	403
SOL3531-140-21	6G5-45972-02-98	403
SOL3531-140-23	6G5-45976-01-98	403
SOL3531-143-17	6G5-45978-03-98	403
SOL3531-145-15	6G5-45970-02-98	403
SOL3532-140-19	6K1-45974-02-98	403
SOL3532-140-21	6K1-45972-01-98	403
SOL3532-140-23	6K1-45976-00-98	403
SOL3532-143-17	6K1-45978-02-98	403
SOL3532-145-15	6K1-45970-01-98	403
SOL3571-145-25		403
SOL3571-145-27		403
SOL3571-148-23	6G5-45949-00-98	403
SOL3571-150-21	6G5-45949-00-98	403
SOL3571-153-19	6G5-45945-01-98	403
SOL3571-155-17	6G5-45947-01-98	403
SOL3571-158-15	6G5-45941-00-98	403
SOL3572-148-23		403
SOL3572-150-21		403
SOL3572-153-19	6K1-45945-01-98	403
SOL3572-155-17	6K1-45947-00-98	403
SOL3572-158-15	6G5-45952-00-98	403
SOL9311-110-15		404
SOL9311-111-13		404
SOL9311-111-14		404
SOL9311-114-12		404
SOL9311-116-11		404

REF	R.O. / OEM	
SOL9311-120-10		404
SOL9311-121-09		404
SOL9331-110-15		404
SOL9331-111-13		404
SOL9331-111-14		404
SOL9331-114-12		404
SOL9331-116-11		404
SOL9411-132-19		404
SOL9411-132-21		404
SOL9411-133-17		404
SOL9411-135-15		404
SOL9411-138-13		404
SOL9411-140-09		404
SOL9411-140-11		404
SOL9431-130-19		404
SOL9431-130-21		404
SOL9431-133-17		404
SOL9431-135-15		404
SOL9431-138-13		404
SOL9432-130-19		404
SOL9432-133-17		404
SOL9432-135-15		404
SOL9432-138-13		404
SOL9511-143-21		404
SOL9511-145-19		404
SOL9511-148-17		404
SOL9511-150-15		404
SOL9511-153-13		404
SOL9511-155-11		404
SOL9511-160-13		404
SOL9531-140-19		404
SOL9531-140-21		404
SOL9531-140-23		404
SOL9531-143-17		404
SOL9531-145-15		404
SOL9532-140-19		404
SOL9532-140-21		404
SOL9532-140-23		404
SOL9532-143-17		404
SOL9532-145-15		404
SOL9571-145-25		404
SOL9571-148-23		404
SOL9571-150-21		404
SOL9571-153-19		404
SOL9571-155-17		404
SOL9571-158-15		404
SOL9572-145-25		404
SOL9572-148-23		404
SOL9572-150-21		404
SOL9572-153-19		404
SOL9572-155-17		404
SOL9572-158-15		404
SOLRBX-102		405
SOLRBX-103		405
SOLRBX-108		405
SOLRBX-117		405
SOLRBX-127		405
STA93900		136
STA93922		136
STA93932		136
STA94100		136
TEN01100	664-45371-01	164-169
TEN01100AL	664-45371-01	164-169
TEN01101	679-45371-00	164-169-365-369
TEN01101AL	679-45371-00	164-169
TEN01102		164
TEN01103	6L6-45371-00	164-169
TEN01103AL	6L6-45371-00	164-169
TEN01104	688-45371-02	164-169
TEN01104AL	688-45371-02	164-169
TEN01105	6E5-45251-00	164-169
TEN01106	6E8-45251-00	164
TEN01107		165
TEN01108	6G1-45251-02	165-169
TEN01109	676-45251-00	163-169
TEN01110	688-45251-01	163-169
TEN01111		163
TEN01112	6G5-45251-01	166-169
TEN01112	6G5-45251-02	166-169
TEN01112AL	6G5-45251-01	166-169
TEN01112AL	6G5-45251-02	166-169
TEN01112-1	6AW-45251	166-169
TEN01113	6H1-45251-03	166-169
TEN01114		167
TEN01115	6H1-45251-02	166-169
TEN01115AL	6H1-45251-02	166-169
TEN01116	6B4-45251-00	348
TEN01116	6E8-45251-02	164
TEN01116	6B4-45251-00	169
TEN01117	6L5-45251-02	166-169
TEN01118	6G1-45251-03	164
TEN01118	6N0-G5251-00	346
TEN01118	6G1-45251-03	169
TEN01119	6T5-45371-00	165
TEN01120	6T5-45373-00	166
TEN01121	689-11325-00	167-229
TEN01122	6T4-45836-00	164
TEN01123	65W-45251-00	164-169
TEN01123	6E0-45251-11-00	164-169
TEN01123AL	65W-45251-00	164-169
TEN01123AL	6E0-45251-11-00	164-169
TEN01124	6T4-45371-00	165-169



REF	R.O. / OEM	
TEN01124AL	61A-45371-00	165-169
TEN01125	6H1-45251-01	167
TEN01126		167
TEN01127	676-45251-00	166-233-235
TEN01128	682-45251-00	166
TEN01129	6E5-45251-00	165
TEN01130	61N-45371-00	165-355
TEN01131	63D-45251-00	165
TEN01131	63D-45251-01	165
TEN01131	63D-45251-00	169
TEN01132	63D-45251-10	163
TEN01132	67C-45251-00	163
TEN01132	63D-45251-10	169
TEN01133	6J9-45371-01	165-169
TEN01133AL	6J9-45371-01	165-169
TEN01134	6K1-45371-02	165-169
TEN01135	61N-45251-01	163-169
TEN01135AL	61N-45251-01	163-169
TEN01136	66M-45371-00	65-164-169
TEN01137	6G8-45251-00	164-169
TEN01138	6AV-45251-00	164
TEN01138	6V3-45251-01	164
TEN01139	6T5-45251-00	167
TEN01140	67F-45371-00	165
TEN01141	67F-45371-00	165-169
TEN01141AL	67F-45371-00	165-169
TEN01142	68T-45251-00	163-169
TEN01143	6J9-45371-00	165
TEN01144	6K1-45371-00	168-169

REF	R.O. / OEM	
TEN01144AL	6K1-45371-00	168-169
TEN01145	69L-45371-00	168-169
TEN01146	67F-11325-00	163
TEN01146-1	67F-11325-01	163
TEN01147	688-11325-00	163-237-243
TEN01148	6G8-11325-00	163-169
TEN01149	62Y-11325-00	163
TEN01150	6J8-11325-00	163-229-231
TEN01151	66M-11325-00	163
TEN01152	6E5-11325-00	163-169-245-247
TEN01153	6E5-45371-00	164
TEN01153	6E5-45371-10	370-375
TEN01154	6AH-45251-00	169
TEN01154AL	6AH-45251-00	65-165
TEN01155	6AW-45373-00	166-169
TEN01155AL	6AW-45373-00	166-169
TEN01156	68V-11325-02	72-167
TEN01156AL	68V-11325-02	72-167
TEN01156-1	68V-11325-01	167
TEN01156/1AL	68V-11325-01	167
TEN01157	6U0-45251-00	165-169
TEN01158	6U4-45373-00	166-169
TEN01159	6U4-45251-00	167-169
TEN01160T	N51-11325-01	167
TEN01161	6BL-11325-00	166
TEN01162	682-11325-00	166-227
TEN01163	68T-11325-00	166
TEN01164	63P-11325-11-00	166-169

REF	R.O. / OEM	
TEN01165	63P-11325-21	211
TEN01165	63P-11325-21-00	163
TEN01165	63P-11325-21	70-71
TEN01166	664-11325-00	225
TEN01166	676-11325-00	166-233-235
TEN01167	63P-11325-01-00	166-169
TEN01168	61A-11325-00	163
TEN01169	6AW-45619-00	165
TEN01170	6AW-11325-00	214
TEN01170	6AW-11325-00	167
TEN01170	6AW-11325-00	73-169
TEN01171	6AQ-1132N-00	73-167-169
TEN01172	6AW-1132R-00	73-167-169-214
TEN01173	6AW-1132L-00	73-167-169
TEN01174	6AW-1132U-00	73-167
TEN01175	6AW-1132T-00	73-167-169
TEN01176	6AW-1132M-00	167-169
TEN01177	6AW-1132P-00	73-168-169-214
TENKITYAMAHA150-200		168
TENKITYAMAHA150-200C		168
TENKITYAMAHA200-250		168
TENKITYAMAHA200-300		168
TENKITYAMAHA40-60		168
TENKITYAMAHA60-90		168
TRI305-0386		74
TRI305-0566		74

## RO / OEM --> REF

R.O. / OEM	REF	
137-11633-10	PAF20-05020003	189-219
30X-12117-00	PAF15-07040006	189-193-195-199-201-203-207
30X-12117-00	PAF15-07050006	185
30X-12118-00	PAF15-07040007	185-189-193-195-199-201-203-207
3FV-13440-00	REC3FV-13440-00	83
3FV-13440-10	REC3FV-13440-00	83
3FV-13440-20	REC3FV-13440-00	83
3FV-13440-30	REC3FV-13440-00	67-83
3YF-12113-00	PAF20-05030004	189
41106-ZW-000	CM41106-ZW000	158
50M-14355-00	REC50M-14355-00	99
51Y-12114-00	PAF25-05050005	193-195-199-201-203-207
51Y-12119-00	PA166F-010003	173-180-189-195-201
51Y-12119-00	PAF166-010003	179-193
51Y-12119-00	PAPS2700.04.03	175-185-199-203-205-207-213
5GH-13440-00	PAF15-07010023	183
5GH-13440-00	PAF25-05000100	191
5GH-13440-00	REC5GH-13440-00	83-183-191-197-209
5GH-13440-10	REC5GH-13440-00	207
5GH-13440-20	REC5GH-13440-60	195-203
5GH-13440-30	REC5GH-13440-00	83
5GH-13440-50	REC5GH-13440-60	83-201-205
5GH-13440-60	REC5GH-13440-60	65-66-67-68-69-83-187
5GH-13440-70	REC5GH-13440-00	65-66-67-68-69-70-71-83
60E-81950-00	REC60E-81950-00	115
60H-12416-00	REC60H-12416-00	245-247
60R-12113-00	PAF6-04050003	179
60R-E2414-A0	REC60R-E2414-A0	180
60R-G6241-00	REC60R-G6241-00	180
60V-11181-00	REC60V-11181-00	249-254
60V-12411-00	REC60V-12411-00	70-137
60V-13621-A0	REC60V-13621-A0	276
60V-13645-00	REC60V-13645-00	276
60V-13907-00	REC60V-13907-00	86
60V-24251-01	REC60V-24251-01	82
60V-43880-00	PH200-T069	123
60V-44150-00	REC60V-44150-00	385
60V-45113-02	REC60V-45113-02	254
60V-45300-20-8D	REC421-A25	281
60V-45332-00-94	REC60V-45332-00-94	383
60V-45611-00	REC60V-45611-00	383
60V-81800-00	PH130-0076	112
60V-81950-00	REC60V-81950-00	115
60V-81960-00	REC60V-81960-05	117
60V-81960-01	REC60V-81960-05	117
60V-81960-02	REC60V-81960-05	117
60V-81960-03	REC60V-81960-05	117
60V-81960-04	REC60V-81960-05	117
60V-81960-05	REC60V-81960-05	117
60W-45300-20-8D	REC428-A25	281
60X-44315-A0	REC60X-44315-A0	339-386
60X-81800-00	PH130-0076	112
60X-W0078-00	REC60X-W0078-00	153-157-386

R.O. / OEM	REF	
612-45611-00	REC612-45611-00	295
61A-11193-A2	REC61A-11193-A2	255
61A-11325-00	CM61A-11325-00	161
61A-11325-00	TEN01168	163
61A-11381-A0	REC61A-11381-A0	276
61A-11650-00	REC61A-11650-00	261
61A-12414-A0	REC61A-12414-A0	138-231
61A-13411-00	REC61A-13411-00	83
61A-13621-A0	REC61A-13621-A0	276
61A-13645-00	REC61A-13645-00	276
61A-13646-00	REC61A-13646-00	276
61A-24563-00	REC61A-24563-00	81-82
61A-43811-00	REC48630-92J00	125
61A-43821-00	REC48630-94900	125
61A-43821-09	REC48630-94900	125
61A-43880-00	PH200-T050	124
61A-43880-01	PH200-T050	124
61A-44311-00	REC61A-44311-00	155-156-157-385
61A-44311-01	REC61A-44311-00	325-329-333-339-377-381-386
61A-44322-02	REC61A-44322-02	155-156-157-325-329-333-339-377-381-386
61A-45113-A0	REC61A-45113-A0	254
61A-45214-10	REC61A-45214-10	383
61A-45214-11	REC61A-45214-10	331
61A-45215-10	REC61A-45215-10	383
61A-45215-11	REC61A-45215-10	331
61A-45321-01	REC61A-45321-01	333-385
61A-45331-00-94	REC61A-45331-00-94	333-385-386
61A-45371-00	CM61A-45371	160-169-383
61A-45371-00A	CM61A-45371-00A	160-169-331-335-337
61A-45371-00	TEN01124	165-169
61A-45371-00	TEN01124AL	165-169
61A-45376-00	REC61A-45376-00-94	333-339
61A-45376-00-94	REC61A-45376-00-94	341-385
61A-45501-20	REC61A-45501-20	385
61A-45501-30	REC61A-45501-30	385
61A-45527-00	REC61A-45527-00	325-329-333-377-381-385
61A-45538-00	REC61A-45538-00	377-381-385
61A-45567-00	REC61A-45567-00/60-0	331-337
61A-45577-00	REC61A-45577-00/60-0	331-337
61A-45587-00	REC61A-45587-00/60-0	333-339
61A-45587-00/60	REC61A-45587-00/60-0	385
61A-45631-03	REC61A-45631-03	383
61A-45632-00	REC61A-45632-00	331-337-383
61A-45633-00	REC61A-45633-00	331-337-383-392
61A-45634-01	REC61A-45634-01	331-337-341-383
61A-45635-00	REC61A-45635-00	331-335-337-341-383
61A-45641-02	REC61A-45641-02	331-337-383
61A-81800-01	PH130-0059	110
61A-81800-01	PH130-0059	110
61A-81941-00	REC61A-81941-00	110-114
61A-81950-00	REC61A-81950-01	115
61A-81950-01	REC61A-81950-01	115

R.O. / OEM	REF	
61A-81960-00	REC61A-81960-04	117
61A-81960-01	REC61A-81960-04	117
61A-81960-02	REC61A-81960-04	117
61A-81960-03	REC61A-81960-04	117
61A-81960-04	REC61A-81960-04	117
61A-85885-00	REC6X2-85885-10	103
61A-W0001-A1	REC61A-W0001-01	252-254
61A-W0078-01	REC61A-W0078-A1	153
61A-W0078-A1	REC61A-W0078-A1	328-383
61A-W0078-A3	REC61A-W0078-A1	71-72-155-157-333
61A-W0093-01	REC61A-W0093-01	97
61B-82510-01	REC61B-82510-02	113
61H-81800-00	PH130-0051	110
61H-81800-01	PH130-0051	110
61N-11181-A1	REC61N-11181-00	229
61N-11181-A2	REC61N-11181-00	248-254
61N-11515-00	REC61N-11515-00	229
61N-11603-00	REC61N-11603-00	229-263-266
61N-11604-00	REC61N-11604-00	229-263
61N-11605-00	REC61N-11605-00	229-263
61N-11631-00-95	REC61N-11631-00K	229-263-266
61N-11635-00	REC61N-11635-00K	229-263
61N-11636-00	REC61N-11636-00K	229-263
61N-14198-00	REC61N-14198-00	274
61N-14301-04	REC61N-14301-04	91-93
61N-24521-00	PAF15-07080002	80
61N-24560-00	PAF15-07080000	80
61N-24563-00	REC61N-24563-10	80
61N-24563-10	REC61N-24563-10	65-66-68-69-80-81-82
61N-26311-00	REC61N-26311-00	129
61N-44146-00	REC61N-44146-00	361
61N-44311-01	PAF25-04050000	297
61N-44311-01	PAF25-04050001	148-154-155-297-355
61N-44322-01	REC61N-44322-00	154-155-297-355
61N-44323-00	REC61N-44323-00	149-154-155-297-355
61N-44362-10	PAF25-04000017S	297-355
61N-44362-10	PAF25-04000017	297-355
61N-45127-00	PAF25-04000013	297-355
61N-45214-00	PAF25-04000021	295
61N-45251-00	PAF15-06000004	295
61N-45251-01	CM61N-45251-01	160-169-291-351-355
61N-45251-01	CM61N-45251-01A	65-66-160-169
61N-45251-01	TEN01135	163-169
61N-45251-01	TEN01135AL	163-169
61N-45311-02-4D	PAF25-04000001	295
61N-45315-00	PAF25-04000009	297-355
61N-45361-01-4D	PAF25-04070001	295-355
61N-45361-01-8D	PAF25-04070000	295-388-389
61N-45371-00	TEN01130	165-355
61N-45510-00	PAF25-04010000S	297
61N-45510-00	REC61N-45510-00	355-388-389
61N-45510-10	PAF25-04010000L	297
61N-45510-10	REC61N-45510-10	355-388-389
61N-45536-00	PAF25-04000002	297-355
61N-45551-00	PAF25-04000005	295
61N-45551-00	REC	

R.O. / OEM	REF		R.O. / OEM	REF		R.O. / OEM	REF	
61N-45560-10	REC61N-45560-10	355-388-389	633-11634-00	REC663-11634-00	233-263	63P-43880-11	REC63P-43880-22	124
61N-45571-00	PAF25-04070004	295	633-85518-00	REC663-85518-00	132	63P-43880-12	REC63P-43880-22	124
61N-45571-00	REC61N-45570-00	355-388-389	634-11633-00	PAF15-07020006	183-219	63P-43880-22	REC63P-43880-22	124
61N-45587-00-10	PAF25-04000003-2	297	634-11633-00	REC634-11633-00	227-260-262	63P-45300-00-8D	REC416-B20F	278
61N-45587-00-11	PAF25-04000003-3	297	63AH-61350-00	PAF20-07000100W	130	63P-45300-02-8D	REC416-B20F	327
61N-45587-00-12	PAF25-04000003-4	297	63D-11181-A2	REC63D-11181-A1	237-248-254	63P-45300-10-8D	REC416-B25F	278
61N-45587-00-13	PAF25-04000003-5	297	63D-11193-A0	REC63D-11193-A0	237-255	63P-45300-12-8D	REC416-B25F	327
61N-45587-00-14	PAF25-04000003-6	297	63D-11603-00	REC63D-11603-00	237-263	63P-45501-00	REC63P-45501-00	329-333
61N-45587-00-15	PAF25-04000003-7	297	63D-11605-00	REC63D-11605-00	237-263	63P-45501-10	REC63P-45501-10	329-333
61N-85540-00	REC61N-85540-00	119	63D-44144-00	PA60-04000004	305-309-313	63P-45551-00	REC63P-45551-00	327
61N-85570-00	REC61N-85570-01	105	63D-44311-00	REC63D-44311-01	148-156-309-313	63P-45987-00	REC6E5-45987-00	323-327
61N-85570-01	REC61N-85570-01	105				63P-46241-00	REC63P-46241-00	211-267
61N-W0001-E1	REC61N-W0001-E1	145-354	63D-44312-00	REC63D-44312-00	301-305-309-313-317-361	63P-81800-00	PH130-0073	112
61N-W0078-10	REC61N-W0078-11	150				63P-81950-00	REC63P-81950-00	115
		65-66-150-154-155-297-354	63D-44316-00	REC63D-44316-00	301-305-309-313-361	63P-81960-01	REC63P-81960-02	116
61N-W0078-11	REC61N-W0078-11	150				63P-81960-02	REC63P-81960-02	116
		93-96-229	63D-44322-00	REC63D-44322-00	154-156-301-305-309-313-317-361	63P-81960-02	REC63P-81960-02	116
61N-W0093-00	REC61N-W0093-00	336				63P-82380-00	REC63P-82380-00	90-102
61P2-W0078-00	REC62P-W0078-00	336	63D-44323-00	REC63D-44323-00	154-156-305-309-313	63V-11181-A1	REC63V-11181-A1	248
61T-11193-A1	REC61T-11193-A0	229-255	63D-44323-00-00	REC63D-44323-00	149	63V-11181-A2	REC63V-11181-A1	227-254
61T-45113-A0	REC61T-45113-A0	253-254	63D-44341-00	REC63D-44341-00	301-309-361	63V-11412-00	REC63V-11412-00	227-256
61T-W0001-02	REC61T-W0001-02	229-250-254-266-267	63D-45114-A0	REC63D-45114-A0	272	63V-11422-00	REC63V-11422-00	227-256
624-14485-00	PAT15-04010202	235	63D-45123-00	REC63D-45123-00	269	63V-11432-00	REC63V-11432-00	227-256
		221-225-227-231-233-237-239-241-243	63D-45214-00	PAT40-04000022	299-303-307-311	63V-11442-00	REC63V-11442-00	227-256
624-14485-00	REC624-14485-00	75				63V-11445-00	REC63V-11445-00	227
		98	63D-45215-00	PAT40-04000023	299-303-307-311	63V-11515-02	REC63V-11515-02	227
624-24634-00	PAF4-04120103	98	63D-45251-00	TEN01131	165-169	63V-14126-00	REC63V-14126-00	94
626-14390-90	REC626-14390-90	349-353	63D-45251-01	CM63D-45251-01	159-169	63V-14301-00	REC63V-14301-00	93
626-44365-01	REC626-44365-01	291-292-349	63D-45251-01	TEN01131	165	63V-14984-00	REC63V-14984-00	94
626-45316-09	REC626-45316-09	293-351	63D-45251-10	TEN01132	163-169	63V-14985-00	REC63V-14985-00	93-100
626-45577-00	PAF15-06080006-1	291-349	63D-45321-00	PAF60-04000101	305-309-313	63V-15396-01-CA	REC63V-15396-01-CA	227
626-45577-00-01	PAF15-06080006-1	349	63D-45344-00	PAF60-04000008	313	63V-15713-00	PAF15-07130107	112
626-45577-00-03	PAF15-06080006-2	349	63D-45361-02-4D	REC63D-45361-02-4D	299-307-361	63V-15714-00	PAF15-07130201	113
626-45577-00-05	PAF15-06080006-5	293	63D-45361-02-8D	PAF60-04030000	307-311	63V-15716-00	PAF15-07130001	113
626-45577-10	PAF15-06080006-2	293	63D-45361-02-8D	REC63D-45361-02-8D	303-311-389-390	63V-15741-00	PAF15-07130202	112
626-45577-20	PAF15-06080006-3	293				63V-15767-00	PAF15-07130203	112
626-45577-30	PAF15-06080006-4	293	63D-45375-00	PAT40-04000014	301-305-309-313	63V-15784-00	PAF15-07130204	112
626-45577-40	PAF15-06080006-5	293	63D-45375-00	REC688-45375-00	317-321-325	63V-24411-00	REC63V-24411-00	87
62P-14984-00	REC62P-14984-00	72-73-86-88	63D-45577-10	PAT40-04060005-2	299-303-307-311	63V-41111-00-1S	REC63V-41111-00-1S	227
62X-43880-00	PH200-T035	122	63D-45577-20	PAT40-04060005-3	299-303-307-311	63V-41112-A0	REC63V-41112-A0	140-227
62X-43880-01	PH200-T035	122				63V-41113-00-1S	REC63V-41113-00-1S	227
62X-43880-09	PH200-T035	122	63D-45577-30	PAT40-04060005-4	299-303-307-311	63V-41133-A1	REC63V-41133-A1	268
62Y-11325-00	CM62Y-11325-00	158	63D-45577-40	PAT40-04060005-5	299-303-307-311	63V-43111-00-4D	PAF15-01010100	131
		65-66-67-68-69-158-197-203-205-207	63D-45577-50	PAT40-04060005-6	299-303-307-311	63V-43111-01-4D	PAF15-01010100	131
62Y-11325-00	CM62Y-11325-00A	191	63D-45577-60	PAT40-04060005-7	299-303-307-311	63V-43111-A2-4D	PAF15-01010100	131
		191	63D-45577-70	PAT40-04060005-8	299-303-307-311	63V-43112-00-4D	PAF15-01010200	131
62Y-11325-00	PAF25-02010005	163	63D-45611-00	PAF60-04020001	303-307-311	63V-43112-01-4D	PAF15-01010200	131
62Y-11325-00	TEN01149	163	63D-45635-00	PAF60-04020005	303-307-311	63V-43131-00	PAF15-01010001	131
62Y-11372-01	PAF25-05010113	191	63D-85540-00	REC63D-85540-04	118	63V-43131-01	PAF15-01010001	131
62Y-11416-00	PAF25-05010302-1	193-199	63D-85540-01	REC63D-85540-01	118	63V-43131-10	PAF15-01010001	131
62Y-11416-10	PAF25-05010302-2	193-199	63D-85540-02	REC63D-85540-02	118	63V-43131-10-4D	PAF15-01010001	131
		193-199	63D-85540-03	REC63D-85540-03	118	63V-43145-00	PAF15-01010007	131
62Y-11633-00	PAF25-05020105	201-203-205-207-219	63D-85540-04	REC63D-85540-04	118	63V-43311-00-4D	PAF15-01010301S	131
		199	63D-85540-05	REC63D-85540-05	118	63V-43311-01-4D	PAF15-01010301S	131
62Y-11650-10	PAF25-05020200	193-199	63D-85540-06	REC63D-85540-06	118	63V-44150-00	PAF15-06030000S	291-351
62Y-11654-00	PAF25-05020204	193-199	63D-85540-07	REC63D-85540-07	118	63V-44150-10	PAF15-06030000L	291-351
62Y-11656-00	PAF25-05020203-1	193-199	63D-85540-08	REC63D-85540-08	118	63V-44301-00	REC63V-44301-00	289-291-351
62Y-11656-00	PAF25-05020203-2	193	63D-85540-09	REC63D-85540-09	118	63V-44301-00	REC63V-44301-00	154-155
62Y-11656-10	PAF25-05020203-2	199	63D-W0001-00	REC63D-W0001-00	237-251-254-68-69-151-154-156-306-310	63V-44301-00-00	REC63V-44301-00	147
62Y-12116-00	PAF20-05030003	189	63D-W0078-01	REC63D-W0078-01	211-215-218	63V-44322-00	REC63V-44322-00	154-155-289-291-293-351
62Y-12116-00	PAF25-05050003	193-199-201-203-207	63P-11181-00	REC63P-11181-00	161			351
62Y-12121-00	PAF25-05050002	193-199-207	63P-11325-00	CM63P-11325-01	161	63V-44323-00-00	REC63V-44323-00	149
		185-189-193-195-199-201-203-205-207	63P-11325-01	CM63P-11325-01A	161	63V-44328-00	PAF15-06000014	289-291-351
62Y-12158-00	PAF15-07040304	185-193-199	63P-11325-01	CM63P-11325-01A	161-211-214	63V-44328-01	PAF15-06000014	293
		193-199-207	63P-11325-01-00	TEN01167	166-169	63V-44338-00	REC664-44338-00	351
62Y-12159-00	PAF15-07040303	193-199-207	63P-11325-11	CM63P-11325-11	161-169	63V-44352-01	CEF500363	143
62Y-12216-00	PAF25-05050011	193-207	63P-11325-11A	CM63P-11325-11A	71-73-161-211	63V-44352-01	REC63V-44352-01	143-154-155-291-293-351
62Y-12231-00	PAF25-05050012	193-207	63P-11325-11-00	TEN01164	166-169	63V-44361-01	REC63V-44361-01	351
62Y-12238-00	PAF25-05050009	193-207	63P-11325-21	TEN01165	70-71-211	63V-44361-11	REC63V-44361-11	351
62Y-12279-00	PAF40-05040003	207	63P-11325-21-00	TEN01165	163	63V-44365-10	PAF15-02000006	293-350
		66-67-68-69-138-183-191-195-197-201	63P-11351-00	REC63P-11351-01	211-218	63V-45113-A1	REC63V-45113-A1	227-253-254
62Y-12414-00	PAF15-07010022	203-205-207	63P-12414-00	REC63P-12414-00	71-138-211	63V-45215-00	PAF15-06000002	293-350
		203-205	63P-13761-00	REC63P-13761-01	90	63V-45300-00-4D	REC63V-45300-03-8D	279
62Y-12481-10	PAF25-05010113	203-205	63P-13761-01	REC63P-13761-01	90	63V-45300-03-4D	REC63V-45300-03-8D	279
62Y-14392-00	REC61N-14392-00	93-98	63P-13906-00	REC63P-13906-01	89-90	63V-45300-03-8D	REC63V-45300-03-8D	279
62Y-14485-00	PAF20-05040005	195	63P-13907-00	REC63P-13907-03	86	63V-45300-10-4D	REC63V-45300-13-8D	279
		197-201-203-207	63P-13907-01	REC63P-13907-03	86	63V-45300-13-4D	REC63V-45300-13-8D	279
62Y-14485-00	PAF40-05070002	207	63P-13907-02	REC63P-13907-03	86	63V-45300-13-8D	REC63V-45300-13-8D	279
		271	63P-13907-03	REC63P-13907-03	86	63V-45300-13-8D	REC63V-45300-13-8D	279
62Y-15312-00	REC62Y-15312-00	85	63P-13915-00	REC63P-13915-00	70-71-72-73-82	63V-45311-01-4D	PAF15-06000001	351
62Y-24410-04	PAF25-05130000	85	63P-14984-00	REC63P-14984-00	71-86-88	63V-45315-A0	REC63V-45315-A0	291-351
62Y-24471-00	PAF25-05130005	87	63P-15312-00	REC63P-15312-00	272	63V-45331-00-5B	REC63V-45331-00-5B	291-351
62Y-								



R.O. / OEM	REF		R.O. / OEM	REF		R.O. / OEM	REF	
63V-61350-00	PAF15-1102000W	130	64E-43821-05	REC48630-92J00	125	65W-45251-00	TEN01123AL	164-169
63V-85520-00	REC63V-85520-00	106	64E-43821-08	REC48630-96J03	125	65W-45300-00-4D	PAF25-04090000S	295
63V-85533-00	REC63V-85533-00	104	64E-43821-09	REC48630-96J03	125	65W-45300-01-4D	PAF25-04090000L	278
63V-85540-00	REC63V-85540-00-01	118-119	64E-43822-00	REC64E-43822-00	125	65W-45300-01-4D	PAF25-04090000S	278
63V-85540-01	REC63V-85540-00-01	118-119	64E-4384J-00	REC64E-4384J-00	125	65W-45300-10-4D	PAF25-04090000L	295
63V-85540-02	REC63V-85540-00-01	118	64E-43880-02-40	REC18-6865	124	65W-45331-00-5B	PAF25-04000008	297
63V-85570-00	REC63V-85570-00	105	64E-43880-02-40	REC63P-43800-20	124	65W-46241-00	REC65W-46241-00	193-199-267
63V-85580-01	REC63V-85580-01	107	64J-12159-00	PAF15-07040303	189	65W-61350-00	PAF25-07000300W	130
63V-W0001-00	REC63V-W0001-00	226	64J-24560-00	REC64J-24560-10	80	65W-81800-00	PH130-0029	111
63V-W0001-01	REC63V-W0001-00	249-254	64J-24560-10	REC64J-24560-10	80	65W-81800-01	PH130-0029	111
63V-W0001-21	REC63V-W0001-21	144	64J-W0001-20	REC64J-W0001-20	145	65W-81800-02	PH130-0029	111
63V-W0078-00	REC63V-W0078-01	150	64J-W0001-21	REC64J-W0001-21	146-333	65W-81800-03	PH130-0029	111
63V-W0078-01	REC63V-W0078-01	65-154-155-290-350	64K-45300-02-NA	REC416-B20	281	65W-81941-00	PH375-0034	111-114
63V-W0093-00	REC63V-W0093-00	93-95-226	64P-45300-10-8D	REC418-A25	280	65W-81941-00	PH375-0036	110
63V-W4311-00-4D	PAF15-01010200	131	64P-45300-10-8D	REC418-B25F	278	65W-82504-00	PAF15-07010103	103
63V-W4311-03-4D	PAF15-01010200	131	64P-45300-12-8D	REC418-B25F	327	65W-82575-01	REC65W-82575-01	120
63V-WS431-B6-8D	PAF15-01010200	131	650-11370-00	REC650-11370-00	231	65W-85510-10	PAF25-05140000	121
63W-13610-00	REC63W-13610-00	92-99	650-11370-01	REC650-11370-00	225-235-237-239-241-243	65W-85550-01	PAF25-05150000	109
646-11633-00	REC646-11633-00	220	650-11651-00	REC650-11651-04	227-260	65W-85570-01	PAF25-05120000	104
646-11651-00	REC646-11651-00	260-261	650-14385-00	REC650-11651-01	100	65W-85580-00	PAF25-05110000	107
646-11651-02	REC646-11651-02	220-260	650-14485-03	REC650-14485-03	227	65W-85790-00	PAF25-0510201	103
646-11681-00	REC646-11681-00	220-260	650-24351-00	REC650-24351-51	75	65W-W0001-00	REC65W-W0001-00	217
646-14623-A1	REC646-14623-A1	220-254-270	650-24351-01	REC650-24351-51	75	65W-W0001-02	REC65W-W0001-00	190-
646-24251-01	PAF4-05000300	80	650-24351-50	REC650-24351-51	75	65W-W0001-02	REC65W-W0001-00	218
646-24251-01	REC35-80365M	80	650-24351-51	REC650-24351-51	75	65W-W0001-20	REC65W-W0001-20	145-297
646-24251-02	PAF4-05000300	64-80-81				65W-W0093-02	REC8542561	95-190-197
646-24251-02	REC35-80365M	80-82-83	650-24378-00	PAF4-04010102	173-175-177-179-180-235-237-241	661-41262-01	PAF15-07000016	100
646-44322-00	REC646-44322-00	343	650-24431-A0	REC650-24431-A0	88	661-41262-02	PAF15-07000016	100
646-44323-00	REC646-44323-00	343	650-44147-00	REC650-44147-00	134-363-367	662-44352-01	CEF500321	143
646-44323-00	REC646-44323-00	148-155	650-45635-00	REC650-45635-00	291-293-349-351	662-44352-01	REC662-44352-01	143-347
646-44352-01	CEF500324	143	655-12414-A1	REC655-12414-A1	351	663-11193-A0	REC663-11193-00	239-255
646-44352-01	REC646-44352-01	143-155-343	65E-85570-00	REC655-12414-A1	138-229	663-11411-01	REC663-11411-00	239-256
646-44365-00	REC646-44365-00	343	65F-42537-00	REC63V-85570-00	105	663-11561-00	REC663-11561-00	239
646-44366-01	REC646-44366-01	343	65L-13645-00	PAF15-01000001	133	663-11633-00	REC663-11633-00	239-243-260-261-264
646-45534-00-03	PAF2.6-03000017	343	65L-13646-00	REC65L-13645-00	275	663-11634-00	REC663-11634-00	235-263
646-45551-00	REC646-45551-00	343-387	65L-13761-00	REC65L-13646-00	275	663-12414-A0	REC663-12414-00	138-239
646-45560-00	REC646-45560-00	343-387	65L-13907-00	REC65L-13761-00	89-90	663-12416-00	REC663-12416-00	235-239
647-11610-00	REC647-11610-00	225-262-266	65L-24563-00	REC6AW-14984-00	86	663-13621-A0	REC663-13621-00	275
647-11610-10	REC647-11610-10	225	65N-45321-00	REC65L-24563-00	71-72-81-82	663-14198-A0	REC663-14198-00	275
647-11610-20	REC647-11610-20	225	65N-W0078-A1	REC65N-45321-00	335	663-14483-A0	REC663-14483-A0	275
647-14323-00	REC647-14323-00	98	65W-08M87	REC65N-W0078-A1	152-157	663-14548-00	REC663-14548-00	99
647-14323-00	REC6G1-14985-00	93-100	65W-11111-02-94	PAGB/T5782-M8X35	191	663-14923-00	REC663-14923-00	99
647-14385-00	REC647-14385-00	100	65W-11119-00	PAF25-05050100	191	663-24411-00	REC663-24411-00	87
647-14386-10	REC647-14386-10	99	65W-11168-00	PAF25-05010106	197	663-41114-A0	REC663-41114-00	142-239
647-44366-00	REC647-44366-00	154-155-291-346-347-351	65W-11169-00	PAF25-05010103	191	663-42138-00	REC663-42138-00	130
647-45316-09	REC647-45316-09	347	65W-11181-30	PAF25-05010108	191	663-43118-01-4D	REC663-43118-01-4D	134
647-45551-00	REC647-45551-00	347-387	65W-11191-00-94	PAF25-05040000	191-215-218	663-44144-01	REC663-44144-01	369-371
647-45560-00	REC647-45560-00	347-387	65W-11351-10	PAF25-05000005	191	663-44151-00	REC663-44151-00	369-371
647-45570-01	REC647-45570-00	347-387	65W-11356-00	PAF25-00000013	191	663-44311-02	REC663-44311-02	155-156-359-369
647-45943-00-EL	SOL3011-090-07-P	402	65W-11356-00	PAF25-00000013	217-218	663-44311-02-00	REC663-44311-02	147
648-11633-00	REC648-11633-00	237-260-261-263-264	65W-11411-01	PAF25-05000004	191	663-44315-A0	REC663-44315-A0	155-156-357-359-369
648-13621-A1	REC648-13621-A0	273	65W-11476-00	PAF25-05000022	193-199	663-44316-A0	REC663-44316-A0	357-359-369
648-13645-A0	REC648-13645-A0	273	65W-11536-10	PAF25-05000021	193-199	663-44322-00	REC663-44322-00	154-155-156-357-359-369
648-14198-A0	REC648-14198-A0	274	65W-11537-01	PAF25-05050017	193	663-44323-00	REC663-44323-00	149-155-156-357-359-369
648-14384-01	REC648-14384-01-00	94	65W-11631-00-96	PAF25-05020100	193-199-219	663-44324-A0	REC663-44324-A0	357-359-369
648-14385-00	REC648-14385-00	100	65W-11631-00-96	PAF25-05020101	193-199	663-44341-00	REC663-44341-00	369
648-24411-00	REC648-24411-00	87	65W-11642-11	PAF25-05020301	193			
648-24434-01	REC648-24434-01	88	65W-11665-00	PAF25-05020310	193			
648-24435-02	REC648-24435-02	88	65W-12146-00	PAF25-05050008	193			
648-44146-00	REC648-44146-00	134	65W-12151-00	PAF25-05050300	193			
		291-295-349-351-353-355-357	65W-12151-00	PAF25-05050301	193-199	663-44366-00	REC663-44366-00	154-155-156-301-305-309-313-317-321-333-357-359-361-363-367-369-371-373-385
648-45633-11	PAF25-04060000	295	65W-12228-00	PAF25-05050200	193			
648-45633-11	REC648-45633-00	293-387-388-389	65W-13286-00	PAGB/T5783-M6X20	191			
648-45635-00	REC648-45635-00	295-353-355	65W-13286-00	PAF25-05010107	191			
64D-11603-01	REC64D-11603-01	245	65W-13300-00	PAF25-05010107	191	663-44367-00	PAT40-02000002	301-305-309-313-317-321-367-371
64D-11603-02	REC64D-11603-01	247-265	65W-14457-10	PAF25-05050400	193	663-44551-02-8D	REC663-44551-02-8D	135
64D-11603-02	REC64D-11603-01	266-267	65W-14901-12	PAF25-05070000	91	663-45123-00	REC663-45123-00	268
64D-11603-04	REC64D-11604-01	265	65W-15100-00-94	PAF25-05010000	191	663-45331-00-94	REC663-45331-00-94	369-390
64D-11603-05	REC64D-11605-01	265	65W-15121-00	PAF25-05000007	191	663-45375-00	REC663-45375-00	367
64D-11604-01	REC64D-11604-01	245-247	65W-15663-00	PAGBT3452-1-97.5X1.8	191	663-45376-00	REC663-45376-00	305-325-335-367
64D-11604-02	REC64D-11604-01	247	65W-24251-00	REC40145	82			
64D-11605-01	REC64D-11605-01	245	65W-24251-10	REC40145	80			
64D-11605-02	REC64D-11605-01	247	65W-41113-01-94	PAF25-05010112	191	663-45376-00-94	REC663-45376-00	301-309-313-317-321-329
64D-11631-02-90	REC64D-11631-00K	247-265-267	65W-41114-00	PAF25-05010111	141-191	663-45510-01	REC663-45510-01	369-390
64D-11642-02-90	REC64D-11642-00K	247-265-267	65W-42138-00	PAF15-01030100	131	663-45552-00	REC663-45552-00	359-365-369
64D-14384-01	REC64D-14384-1	94	65W-43800-00-4D	PAT40-10000000	124	663-45557-00	REC663-45576-00	365
64D-14394-00	REC64D-14394-00	99	65W-43800-01-4D	PAT40-10000000	124	663-45567-01	PAT40-04000004-1	299-303-307-311
64D-45300-01-8D	REC416-A20	280	65W-43800-02-4D	PAT40-10000000	124	663-45567-01-10	PAT40-04000004-1	365
64D-45300-02-8D	REC416-A20	379	65W-43800-03-4D	PAT40-10000000	124	663-45567-01-12	PAT40-04000004-2	365
64D-45300-21-8D	REC416-A25	280	65W-43800-20-4D	PAT40-10000000	124	663-45567-01-15	PAT40-04000004-3	365
64D-45300-22-8D	REC416-A25	379	65W-43800-21-4D	PAT40-10000000	124	663-45567-01-30	PAT40-04000004-5	365
64D-W0093-00	REC64D-W0093-00	97-247	65W-43800-22-8D	PAT40-10000000	124	663-45567-10	PAT40-04000004-2	299-303-307-311
64E-13645-A0	REC							

R.O. / OEM	REF		R.O. / OEM	REF		R.O. / OEM	REF	
663-45587-01-18	PAT40-04000003-4	367	66K-13907-00	REC6AW-14984-00	86	66T-11604-00	REC66T-11604-00	233-263
663-45587-01-30	PAT40-04000003-5	367	66K-13915-00	REC66K-13915-00	82	66T-11605-00	REC66T-11605-00	233-263
663-45587-01-40	PAT40-04000003-6	367	66K-14984-00	REC66K-14984-00	86-88	66T-11631-01-93	REC66T-11631-01K	233-263-266
663-45587-01-50	PAT40-04000003-7	367	66K-45300-12-NA	REC421-A20	281	66T-11635-01	REC66T-11635-01K	233-263
663-45587-10	PAT40-04000003-2	301-305-309-313	66K-45501-00	REC66K-45501-00	385	66T-11636-01	REC66T-11636-01K	233-263
663-45587-20	PAT40-04000003-3	301-305-309-313	66M-11111-01-1S	PAF15-07040000	185	66T-11681-00	REC66T-11681-00	233-260-261
663-45587-30	PAT40-04000003-4	301-305-309-313	66M-11168-001S	PAF15-07010200	183	66T-14301-60	REC66T-14301-60	92-93
663-45587-40	PAT40-04000003-5	301-305-309-313	66M-11181-10	PAF15-07000100	185-215-218	66T-14384-01	REC66T-14384-01	94
663-45587-50	PAT40-04000003-6	301-305-309-313	66M-11191-00-1S	PAF15-07050001	185	66T-14536-01	REC66T-14536-01	94
663-45587-60	PAT40-04000003-7	301-305-309-313	66M-11325-00	CM15008	159	66T-14992-00	REC66T-14992-00	99
663-45631-01	REC663-45631-00	359-363-365-369-389-390	66M-11325-00	CM15008A	159	66T-15713-00	REC66T-15713-00	112
663-45633-00	REC663-45633-00	359-361-363-365-369-389-390	66M-11325-00	PAF15-07010008	183	66T-26301-00	REC66T-26301-00	129
663-45634-00	REC663-45634-00	303-307-311-359-363-365-369	66M-11327-00-94	TEN01151	163	66T-41114-A0	REC66T-41114-A0	141
663-45941-01-EL	SOL3311-110-17	402	66M-11328-00	PAF15-07010011	168-183-191-197-203-205-207	66T-41133-A0	REC66T-41133-A1	269
663-45943-02-EL	SOL3311-110-15	402	66M-11351-10	PAF15-07010009	65-66-67-68-69-183-191-197-203-205-207	66T-44311-00	PAT40-04000201	148-301-305
663-45945-02-EL	SOL3311-111-13	402	66M-11351-10	PAGB/T97.1-8	183-217	66T-44323-00	REC66T-44323-00	149-154-301-361
663-45945-02-EL	SOL3311-111-13	402	66M-11356-00	PAF15-00000014	193	66T-44514-00-4D	REC66T-44514-00-4D	135
663-45947-02-EL	SOL3311-111-13	402	66M-11356-00	PAF15-00000014	233	66T-45113-A0	REC66T-45113-A0	233-253-254
663-45949-01-EL	SOL3311-110-16	402	66M-11356-00	PAF15-00000014	218	66T-45114-A0	REC66T-45114-A0	271
663-45952-02-EL	SOL3311-114-12	402	66M-11357-00	PAF15-07050002	185	66T-45300-10-4D	PAF40-04000000L	279
663-45954-01-EL	SOL3331-119-10	402	66M-11411-00	PAGB/T97.1-8	191	66T-45311-13-8D	PAF40-04000000L	279
663-45956-01-EL	SOL3311-121-09	402	66M-11416-00	PAF15-07010014	183	66T-45321-00	PAT40-04000007	301
663-45958-01-EL	SOL3311-111-14	402	66M-11536-10	PAF15-07030000	183-219	66T-45344-01	PAT40-04000009	301-305-309
663-45970-60-98	SOL3331-114-12	402	66M-11537-00-94	PAF15-07030004	185	66T-45501-01	REC66T-45501-01	361-389
663-45972-60-98	SOL3331-116-11	402	66M-11557-00	PAF15-07030004	185	66T-45501-11	REC66T-45501-10	361-389-390
663-45987-00	REC663-45987-00	365	66M-11631-00-96	PAF15-07030004	185	66T-45551-00	REC66T-45551-00	299-303-361-389-390
663-45987-02	REC663-45987-00	299-303-307-311-359-361-369	66M-11650-00	PAF15-07020001	183-219	66T-45560-01	REC66T-45560-00	299-361-389-390
663-45987-02	REC663-45987-00	405	66M-12111-00	PAF15-07020100	183	66T-45571-00	REC66T-45571-00	299-361-389-390
663-48344-00	REC663-48344-00	127	66M-12113-00	PAF15-07040001	185	66T-45611-00	REC66T-45611-00	299-361-389-390
663-85540-11	REC663-85540-15	119	66M-12116-00	PAF15-07040005	185	66T-45631-00	REC66T-45631-00	299-361-389-390
663-85540-15	REC663-85540-15	119	66M-12121-00	PAF15-07040004	185	66T-45635-00	REC66T-45635-00	299-361
663-W0078-00	REC663-W0078-01	368	66M-12138-60	PAF15-07040002	185	66T-45997-00	REC66T-45997-00	299-361-365-405
663-W0078-01	REC663-W0078-01	152-368	66M-12146-00	PAF15-10030001	185	66T-82575-01	REC66T-82575-01	120
664-11325-00	TEN01166	225	66M-12151-10	PAF15-07040015	185-189	66T-85520-00	REC66T-85520-00	106
664-41114-A0	REC664-41114-A0	140	66M-12170-00	PAF15-07040301	185	66T-85533-00	REC66T-85533-00	104
664-41134-A0	REC664-41134-A0	268	66M-12411-00	PAF15-07040200	185	66T-85540-01	REC66T-85540-00-01	119
664-44338-00	REC664-44338-00	289-291-293-353	66M-12411-01	PAF15-07000031	137	66T-85570-00	REC66T-85570-00	105
664-44338-00	REC664-44338-00	154-155	66M-12535-00	PAF15-07000031	137-179-180-183	66T-85580-00	REC66T-85580-00	107
664-45371-01	CM664-45371-01	357-359-361	66M-13300-10	PAF15-07010012	183-191-197-203-205-207	66T-W0001-01	REC66T-W0001-01	233-250-254
664-45371-01	CM664-45371-01	169	66M-13329-10	PAF15-07040500	185	66T-W0001-20	REC66T-W0001-20	146-361
664-45371-01	TEN01100	164-169	66M-14301-00	PAF15-07040016	185	66T-W0078-00	REC66T-W0078-00	298-361
664-45371-01-00	TEN01100AL	164-169	66M-14301-00	PAF15-07090000	91	66T-W0078-01	REC66T-W0078-01	66-67-152-154
664-45371-01A	CM664-45371-01	353	66M-15100-02-1S	PAF15-07090000W	91	66T-W0093-01	REC66T-W0093-01	93-96-233
664-45371-01A	CM664-45371-01A	66-160-169	66M-24410-11	PAF15-07010000	183	66W-11119-00	PAF25-05010106	191
664-45384-00	REC664-45384-00	353-357	66M-41113-20-1S	PAF15-07010000	183	670-44514-00	REC670-44514-00	135
664-4556-50	PAF15-06000010-7	349	66M-41114-01	PAF15-070140000	85	670-45997-02	REC670-45997-02	359-369
664-45567-01	PAF15-06000010-1	293	66M-41138-00	PAF15-07010019	183	676-11181-A2	REC676-11181-01	249-254
664-45567-05	PAF15-06000010-1	349	66M-41138-00	PAF15-07010018	65-140-183	676-11325-00	TEN01166	166-233-235
664-45567-10	PAF15-06000010-2	293	66M-44361-00	PAF15-07010018	268	676-11372-00	PAF15-04000005	173-179-181-183-195-213-225-227-229-231-233
664-45567-12	PAF15-06000010-2	349	66M-44361-10	PAF15-02000005S	291	676-12414-A0	REC676-12414-A0	233
664-45567-20	PAF15-06000010-3	293	66M-44361-00-4D	PAF15-02000005L	291	676-12414-A1	REC676-12414-A0	138
664-45567-30	PAF15-06000010-4	293	66M-44514-00-4D	PAF15-02010000	135	676-13646-A0	REC676-13646-A0	274
664-45567-40	PAF15-06000010-5	293	66M-44551-00-4D	PAF15-00000001	132	676-14186-00	REC676-14186-00	99
664-45567-50	PAF15-06000010-6	293	66M-44557-00	PAF15-00000003	135	676-14984-00	REC676-14984-00-00	94
664-45631-01	REC664-45631-01	353	66M-45113-00	PAF15-00000003	271	676-14985-01	REC676-14985-01	100
664-45631-02	PAF25-04060003	295	66M-45115-00	PAF15-00000005	268	676-41112-A0	REC676-41112-A0	172
664-45631-02	REC664-45631-00	355-388-389	66M-45300-02-4D	PAF15-03000003	268	676-41133-A0	REC676-41133-A0	269
664-45941-01-EL	SOL3211-099-09	402	66M-45300-11-4D	PAF15-06100000S	277-291	676-41360-00	REC676-43160-02	132
664-45945-00-EL	SOL3211-099-10	402	66M-45371-00	PAF15-06100000L	277-291	676-43160-01	REC676-43160-02	132
664-45947-01-EL	PAF25-04080000	295	66M-46241-00	CM66M-45371-00	159-169-291	676-43160-02	REC676-43160-02	132
664-45947-01-EL	SOL3211-099-11	402	66M-46297-00	TEN01136	65-164-169	676-44311-00	REC676-44311-00	148-156-363-367
664-45949-02-EL	SOL3211-099-13	402	66M-81800-00	REC66M-46241-00	185-267	676-44315-A0	REC676-44315-00	156-363
664-45954-00-EL	SOL3211-099-12	402	66M-81800-01	PAF15-07000024	185	676-44316-A1	REC676-44316-A1	363
664-45970-00-98	SOL3231-103-12	402	66M-81800-02	TEN01136	65-164-169	676-44322-00	REC676-44322-00	156-367
664-45972-00-98	SOL3231-105-11	402	66M-81800-02	PH130-0084	110	676-44323-00	REC676-44323-00-40	149-156-367-363
664-45987-00	REC664-45987-00	353	66M-81800-01	PH130-0034	111	676-44324-A0	REC676-44324-A0	363
664-81970-60	REC6G1-81970-62	116	66M-81800-02	PH130-0084	110	676-44324-A1	REC676-44324-A0	363
664-81970-61	REC6G1-81970-62	116	66M-85520-00	PH130-0084	110	676-44341-94	REC676-44341-00	363
664-81970-62	REC6G1-81970-62	116	66M-85533-00	PAF15-07000300	106	676-44361-00	REC676-44361-00	367
664-81970-63	REC6G1-81970-62	116	66M-85533-00	PAF15-07000400	104	676-44361-10	REC676-44361-10	367
665L-13915-00	REC65L-13915-00	82	66M-85540-10	PAF15-07000500	118	676-44518-00	REC676-44518-00	135
667-41114-A0	REC66T-41114-A0	233	66M-85550-00	PAF15-07070000	109	676-45114-A1	REC676-45114-A1	271
667-45551-00	REC66T-45551-00	303	66M-85550-10	PAF15-07070100W	109	676-45127-00	REC676-45127-00	269
667-45571-00	REC66T-45571-00	303	66M-85570-00	PAF15-07070000	109	676-45128-00	REC676-45128-00	269
667-45997-00	REC66T-45997-00	303-307-311	66M-85570-00	PAF15-07000600	104	676-45251-00	TEN01109	163-169
6689-W0001-C2	REC689-W0001-C2	145	66M-85580-00	REC689-81311-40	105	676-45251-00	TEN01127	166-233-235
66G1-81941-10	REC89-825096T01	114	66M-85580-00	PAF15-07000200	107	676-45314-00	REC676-45314-00	363
66K-13907-00	REC66K-13907-00	86	66M-W0001-01	REC66M-W0001-01	182-216-218	676-45314-01-94	REC676-45314-00	363-390
			66M-W0001-20	REC66M-W0001-20	144-290	676-45501-10	REC676-45501-10	363-389-390
			66M-W0093-01	REC66M-W0093-01	95-182	676-45533-00	REC676-45533-00	363
			66M-W009B-15-1S	PAF15-0700				



R.O. / OEM	REF		R.O. / OEM	REF		R.O. / OEM	REF	
676-81800-10	PH130-0007	111	67D-12121-00	PA166F-010002	173	682-11610-01	REC682-11610-01	227-266
676-81970-00	REC6G1-81970-62	116	67D-12121-00	PAF4-04080006	175-180	682-11610-11	REC682-11610-11	227-262
677-11181-A1	REC677-11181-A0	225-248-254	67D-12151-00	PA166F-010009	173-175-179	682-11610-21	REC682-11610-21	227-262
677-11412-02	REC677-11412-02	225-256	67D-12154-00	PAF4-04000015	175	682-11681-00	REC682-11681-00	227-260
677-11422-02	REC677-11422-02	225-256	67D-12157-00	PA166F-010008	173-175-179	682-12413-00-1S	REC682-12413-00-1S	139-227
677-11432-02	REC677-11432-02	225-256	67D-12413-00-1S	PAF4-04070001	175	682-12413-00-9M	REC682-12413-00-9M	139
677-11442-02	REC677-11442-02	225-256	67D-14301-03	PAF4-04140000	91	682-12414-A1	REC682-12414-A1	138-139-227
677-11631-00-97	REC677-11631-00K	225-262-266	67D-24410-03	PAF4-04090000	85	682-13621-A0	REC682-13621-00	273
677-11635-00	REC677-11635-00K	225-262	67D-24610-00	PAF4-04120100	75	682-41112-A1	REC682-41112-00	140
677-11636-00	REC677-11636-00K	225-262	67D-24610-02	PAF4-04120100	75	682-41114-A1	REC682-41114-00	140
677-11650-01	REC677-11651-00	260	67D-24610-03	PAF4-04120100	75	682-41133-A0	REC682-41133-A0	268
677-13621-A1	REC677-13621-00	273	67D-24610-04	PAF4-04120100	75	682-41237-50	REC682-41237-50	132
677-14198-A1	REC677-14198-A1	273	67D-44366-00	PAF4-03000021	285-287	682-42137-00	REC682-42137-00	132
677-14227-01	REC677-14227-00	94	67D-45113-A0	PAF4-00000006	175-217-218	682-44147-00	REC682-44147-00	349-357
677-14343-68	REC677-14343-68	98	67D-45560-00	PAF4-03010000	285-287-387	682-44176-00	REC682-44176-00	349
677-14384-01	REC677-14384-01	94	67D-45570-00	PAF4-03040000	285-287-387	682-44312-00	REC682-44312-00	349
677-24434-02	REC677-24434-02	273	67D-45631-01	PAF4-03030002	285-287	682-44315-00	REC682-44315-00	154-155-156-349
677-24435-01	REC677-24435-01	87	67D-45635-00	PAF4-03000008	285-287	682-44322-00	REC682-44322-00	154-155-156-349
677-24471-01	REC677-24471-01	87	67D-85640-00	PAF4-04000038	106	682-44323-00	REC682-44323-00	154-155-156-349
677-26301-02	REC677-26301-02	129	67D-W0093-00	REC67D-W0093-00	95-177	682-44328-00	REC682-44328-00	349
677-41112-A1	REC677-41112-A0	225	67F-11181-02	REC67F-11181-03	215-218	682-44352-00	REC682-44352-01	349
677-41114-A0	REC677-41112-A0	140	67F-11181-03	REC67F-11181-03	215-218	682-44352-03	CEF500320	143
677-41114-A1	REC677-41112-A0	225-389	67F-11325-00	CM67F-11325-01	159	682-44352-03	REC682-44352-01	154-155-156
677-45113-A0	REC677-45113-A0	225-252-254	67F-11325-01	TEN01146	163	682-44352-03	REC682-44352-01	349
677-45251-00	CM43107M	169	67F-11325-01	CM67F-11325-01	161	682-44361-01	REC682-44361-10	349
677-45251-00	CM6E0-45251-11	347	67F-11325-01	CM67F-11325-01A	70-71-72-73-161-211-213	682-44361-10	REC682-44361-10	154-155-156-349
677-W0093-00	REC677-W0093-00	95-225	67F-11325-01	TEN01146-1	163	682-44361-10	REC682-44361-10	154-155-156-349
679-14923-00	REC679-14923-00	99	67F-11328-00	REC67F-11328-00	209-211-214	682-44365-00	REC682-44365-00	154-155-156-349
679-14966-00	REC679-14966-00	100	67F-12411-00	REC67F-12411-01	137	682-44514-01-94	REC682-44514-01-94	135
679-44150-00	REC679-44150-00	367	67F-12411-01	REC67F-12411-01	69-70-71-72-73-137-209-211-213	682-44555-30	PAF15-00000002	135
679-44150-10	REC679-44150-10	367	67F-14371-01	REC67F-14371-01	101	682-45113-02	REC682-45113-A0	254-271
679-44152-00	REC679-44152-00	367	67F-24251-02	REC40165	80-81-82	682-45251-00	TEN01128	166
679-44316-A0	REC679-44316-A0	367	67F-41134-A0	REC67F-41134-A0	269	682-45376-01	REC682-45376-01	349
679-44341-00-94	REC679-44341-00	367	67F-41138-00	REC67F-41138-00	269	682-45631-00	REC682-45631-00	291-293-349-351-387-388
679-44514-00-94	REC679-44514-00-94	135	67F-4380R-00	REC48630-94900	125	682-81800-10	PH130-0061	110
679-45251-00	CM679-45251-00	160	67F-4380R-01	REC48630-94900	125	682-81800-11	PH130-0061	110
679-45251-00A	CM679-45251-00A	160	67F-43811-02	REC48630-94900	125	682-81800-12	PH130-0061	110
679-45315-A1	REC679-45315-A1	365	67F-43880-00	PH200-T044	123	682-82556-00	PAF4-01090401	120
679-45321-02	REC679-45321-02	365	67F-44311-00	REC67F-44311-01	321	682-W0078-A1	REC682-W0078-A1	150-154-155-156-348
679-45331-00-94	REC679-45331-00	365	67F-44311-01-00	REC67F-44311-01	148-154-155	683-44361-01	REC683-44361-01	349
679-45371-00	TEN01101	164-169-365-369	67F-44322-00	REC67F-44322-00	321-154-155	683-44365-01	REC683-44365-01	349
679-45371-00	TEN01101AL	164-169	67F-44323-00	REC67F-44323-00	149-154-155-321	683-44373-00	REC683-44373-00	349
679-45501-10	REC679-45501-10	367-389	67F-44352-00	CEF500364	143	683-45315-00	REC683-45315-A0	349
679-45536-00	REC679-45536-00	367	67F-44352-00	REC67F-44352-00	143-321-154-155	683-45361-00-EJ	REC683-45361-01-4D	349
679-45560-00	REC679-45560-00	365-389	67F-45113-00	REC67F-45113-00	272	683-45361-02-4D	REC683-45361-01-4D	291-351
679-45571-00	REC679-45571-00	365	67F-45123-00	REC67F-45123-00	269	683-45361-02-8D	PAF15-06080000	293
679-45611-01	REC679-45611-00	359-365-389-390	67F-45127-00	REC67F-45127-00	269	683-45361-02-8D	REC683-45361-01-4D	293
679-W0078-00	REC679-W0078-A1	151-156	67F-45331-00-94	REC67F-45331-00-CA	319	683-45361-02-8D	REC683-45361-02-4D	387-388
67C-11181-01	REC67C-11181-01	197-215-218	67F-45371-00	CM67F-45371-00	70-161	683-45611-00	REC683-45611-00	291-293-349-351-387-388
67C-11351-01	REC67C-11351-01	197-207-218	67F-45371-00A	CM67F-45371-00A	68-69-161-315-319	683-45941-00-00	SOL3111-093-12	402
67C-11356-00	REC67C-11356-00	197	67F-45371-00	TEN01140	165	683-45942-00-EL	SOL3111-093-10	402
67C-11537-01	PAF40-05040006	199	67F-45371-00	TEN01141	165-169	683-45943-00-EL	SOL3111-093-11	402
67C-11603-00	REC67C-11603-00	193-195-199-201-203-205-219	67F-45371-00	TEN01141AL	165-169	683-45945-00-EL	SOL3111-093-09	402
67C-11650-00	PAF25-05020200	193	67F-45371-00	TEN01141AL	165-169	683-45947-00-EL	SOL3111-093-08	402
67C-12111-00	PAF25-05050001	193-199	67F-45501-10	REC67F-45501-10	321-391	683-W0001-21	REC683-W0001-21	348
67C-15312-00	PAF25-02010007	271	67F-45560-00	REC67F-45560-00	319-390-391	683-W0001-C1	REC683-W0001-21	144
67C-15312-00	REC67C-15312-00	271	67F-45570-00	REC67F-45570-00	391	688-11111-02-1S	REC688-11111-02-1S	243
67C-41114-00	REC67C-41114-00	141	67F-45576-00	REC67F-45576-00	315-319	688-11181-A1	REC688-11181-A1	243
67C-41114-10	REC67C-41114-00	197	67F-45611-01	REC67F-45611-01	315-319-391	688-11181-A2	REC688-11181-A1	249
67C-41133-00	REC67C-41133-00	268	67F-45997-00	REC67F-45997-00	315-319-371-405	688-11181-A2	REC688-11181-A1	254
67C-43880-00	REC67C-43880-01	122	67F-46241-00	REC67F-46241-00	209-267	688-11193-A1	REC688-11193-A1	243-255
67C-43880-01	REC67C-43880-01	122	67F-81800-01	PH130-0055	112	688-11325-00	CM85007	160
67C-45113-00	REC67C-45113-00	271	67F-81800-02	PH130-0055	112	688-11325-00	CM85007A	160
67C-45123-00	REC67C-45123-00	268	67F-81800-03	PH130-0055	112	688-11370-01	TEN01147	163-237-243
67C-45251-00	CM67C-45251-00A	158-169-361-66-67-69-158-299-303-307-311	67F-81800-04	PH130-0055	112	688-11411-01	REC688-11411-00	243-256
67C-45251-00	TEN01132	163	67F-81960-00	REC67F-81960-12	116	688-11603-A0	REC688-11603-A0	239-243-264-266
67C-45371-00	CM67C-45371-00	160-169	67F-85570-00	REC67F-85570-00	105	688-11605-A0	REC688-11605-A0	239-243-264
67C-45371-00	CM67C-45371-00A	66-67-68-69-160-169-299-303-307-311	67F-W0001-00	REC67F-W0001-00	217	688-11610-02	REC688-11610-02	264-266
67C-45501-00	REC67C-45501-00	301-305-389-390	67F-W0001-01	REC67F-W0001-01	209-218	688-11631-02-95	REC688-11631-02K	264-266
67C-45501-10	REC67C-45501-10	301-305-389-390	67F-W0001-20	REC67F-W0001-20	145-318	688-11631-03-94	REC688-11631-03K	239-243-264
67C-45633-00	PAT40-04050005	307-311	67F-W0078-00	REC67F-W0078-00	69-70-152-154-155-318-97-209	688-11631-81-96	REC688-11631-81K	264-266
67C-81800-00	PH130-0028	110	67F-W0093-00	REC67F-W0093-00	209	688-11634-00	REC688-11634-00	229-239-243-263-264
67C-81800-01	PH130-0028	110	67F-11416-10	REC67F-11416-10	209	688-11634-10	REC688-11634-10	241
67C-81800-02	PH130-0028	110	67F-11416-20	REC67F-11416-20	209	688-11635-03	REC688-11635-03K	239-264
67C-W0001-00	REC67C-W0001-01	217	67H-11411-00	REC67H-11411-00	256	688-11635-03	REC688-11636-03K	264
67C-W0001-01	REC67C-W0001-01	197-217	67H-13907-00	REC67H-13907-00	86	688-11636-03	REC688-11636-03K	239
67C-W0001-01	REC67C-W0001-01	218	67H-13907-00	REC67H-13907-00	86	688-11650-03	REC688-11650-03	239-243-264
67C-W0001-20	REC67C-W0001-20	298	67H-43880-00	REC6AW-14984-00	86	688-11651-00	REC688-11651-00	261
67D-11181-A0	PAF4-04000014	175-215-218	67H-8592A-01	REC67H-8592A-01	123	688-12411-10	REC688-12411-10	243
67D-11191-00	PAF4-04000018	175	680-WE090-11-15	PAF4-04000000	175	688-12413-00-1S	REC688-12413-00-1S	139-243
67D-11400-00	PAF4-04030000	175-219	682-11325-00	TEN01162	166-227	688-12414-A1	REC688-12414-A1	138-139-243-245-247
67D-11650-00	PAF4-04020100	175	682-11351-A0	REC682-11351-A0	253	688-12416-00	REC688-12416-00	139-243
67D-11654-00	PAF4-04020103	175	682-11412-00	REC682-11412-00	256	688-13610-00	REC688-13610-00	99
67D-12111-00	PA166F-010001	173-180	682-11422-00	REC682-11422-00	256	688-13621-A1	REC688-13621-A1	274
67D-12111-00	PAF4-04080005	175	682-11432-00	REC682-11432-00	256	688-14198-A2	REC688-14198-A2	274
			682-11442-00	REC682-11442-00	256	688-14416-01	REC688-14416-01	274
			682-11610-00	REC682-11610-01	262			

R.O. / OEM	REF		R.O. / OEM	REF		R.O. / OEM	REF	
688-14483-A0	REC688-14483-A0	274	688-81800-10	PH130-0058	111	68D-G4311-01	PAF4-03000019	147-285
688-14548-00	REC688-14548-00	99	688-81800-11	PH130-0058	111	68D-G4315-A0	PAF4-03000018	285
688-14947-00	REC688-14947-00	98	688-81800-12	PH130-0058	111	68D-G4328-00	PAF4-03000020	285-287
688-24378-00	PAF15-05000011	183-191-195-197-207	688-81950-10	REC688-81950-10	111-114	68D-G4360-00	PAF4-02040001S	285
688-41112-A0	REC688-41112-A0	142-243	688-82560-10	REC688-82560-10	103	68D-G4360-10	PAF4-02040001	285
688-41114-A0	REC688-41114-A0	142-243	688-82575-01	REC688-82575-01	120	68D-G4365-00	PAF4-02040002	283-285
688-41134-A0	REC688-41134-A0	269	688-82586-21	PAF15-13000100W	128	68D-G5251-00	CM6L5-45251-02A	287
688-41211-00	REC688-41211-01	132	688-8258A-10	REC688-8258A	128	68D-G5251-00	PAF4-03000022	64-283-285
688-41211-01	REC688-41211-01	132	688-8258A-20	PAT85-08010100	128	68D-G5300-00-4D	PAF4-03100005	285
688-41217-00	REC688-41217-00	101	688-8258A-30	REC688-8258A-30	128	68D-G5300-10-4D	PAF4-0310000L	285
688-43160-01	REC688-43160-01	132	688-85510-00	REC688-85510-01	121	68D-G5300-11-4D	PAF4-03000001	285
688-43880-11	PH200-T037	123	688-85510-01	REC688-85510-01	121	68D-G5315-A0	PAF4-03000011	285-287
688-44120-11	REC688-44120-12	134	688-85510-10	REC688-85510-10	121	68D-G5321-00	PAF4-03000012	285-287
688-44120-12	REC688-44120-12	134	688-85510-11	REC688-85510-10	121	68D-G5361-00-4D	PAF4-03050001	285-287
688-44120-22	REC688-44120-22	134	688-85540-00	REC688-85540-00	117	68D-G5511-00	PAF4-03000004S	287
688-44311-01	REC688-44311-01	148-156-371	688-85540-16	REC688-85540-16	120	68D-G5511-10	PAF4-03000004L	287
688-44311-01-00	REC688-44311-01	373	688-W0001-02	REC688-W0001-A0	243	68D-G5978-00	PAF4-03000025	283
688-44315-A0	REC688-44315-00	154-155-156-321-371	688-W0001-20	REC688-W0001-20	146	68D-G5987-00	PAF4-03000025	285-287
688-44315-A0-00	REC688-44315-00	373	688-W0001-20-00	REC688-W0001-22	373	68F-11181-00	REC68F-11181-00	249-254
688-44316-A0	REC688-44316-00	321-371	688-W0001-22	REC688-W0001-22	146-370	68F-11193-02	REC68F-11193-02	255
688-44316-A0-00	REC688-44316-00	373	688-W0001-A0	REC688-W0001-A0	251-254	68F-11381-00	REC68F-11381-00	276
688-44322-00	REC688-44322-00	156-371	689-11181-A2	REC689-11181-00	248-254	68F-13440-00	REC68F-13440-00	83
688-44322-00-00	REC688-44322-00	373	689-11325-00	CM3082523	158	68F-13907-01	REC68F-13907-01	86
688-44323-00	REC688-44323-00	156-371	689-11325-00	CM689-11325-00A	158	68F-13915-00	REC68F-13915-00	82
688-44323-00-00	REC688-44323-00	149-373	689-11610-01	TEN01121	167-229	68F-24563-00	REC68F-24563-00	81
688-44324-A0	REC688-44324-00	321-371	689-11610-01	REC689-11610-00	263-266	68F-24563-10	REC68F-24563-10	81
688-44324-A0-00	REC688-44324-00	373	689-11631-00-95	REC689-11631-00K	263-266	68F-41114-00	REC68F-41114-00	142
688-44341-01-94	REC688-44341-01	371-373	689-11633-00	REC689-11633-00	229-260-263	68F-45113-01	REC68F-45113-01	253-254
688-44352-03	CEF500323	143	689-11651-00	REC689-11651-00	229-260-261	68F-81800-00	PH130-0056	111
688-44352-03	REC688-44352-03	143-156-371	689-11681-01	REC689-11681-00	229-260-261	68F-81800-01	PH130-0056	111
688-44352-03-00	REC688-44352-03	373	689-15396-01-5B	REC689-15396-01-CA	229	68F-81800-03	PH130-0056	111
688-44361-10	REC688-44361-10	371	689-15755-00	REC689-15755-00	134	68F-8195A-00	REC68F-8195A-00	115
688-44514-00	REC688-44514-00	135	689-41112-A0	REC689-41112-A0	141	68F-83688-00	REC68F-83688-00	90-102
688-44555-00	REC688-44555-00	135	689-41114-A0	REC689-41114-A0	141	68F-83688-10	REC68F-83688-10	90-102
688-45113-A0	REC688-45113-A0	243-253-254	689-44311-03	REC689-44311-00	147-155-353	68F-8592A-00	REC68F-8592A-00	103
688-45114-A1	REC688-45114-A1	272	689-44315-A0	REC689-44315-A0	353	68F-W0001-01	REC68F-W0001-01	252-254
688-45123-00	REC688-45123-00	269	689-44316-A0	REC689-44316-A0	353	68N-81940-00	PH375-0042	114
688-45214-02	REC688-45214-02	323-365	689-44323-03	REC689-44323-00	155-353	68T-11325-00	CM68T-11325-00	161
688-45215-02	REC688-45215-02	323-365	689-44324-A0	REC689-44324-A0	155-353	68T-11325-00A	CM68T-11325-00A	71-72-73-161-211
688-45251-01	CM688-45251-01	158-169	689-44352-02	CEF500326	143	68T-11325-00	TEN01163	166
688-45251-01	CM688-45251-01A	67-68-69-158-169	689-44352-02	REC689-44352-02	143-155-353	68T-12116-00	PAF4-04800007	175-179-180
688-45251-01	TEN01110	163-169	689-44366-00	REC689-44366-00	155-353-355	68T-13475-00	REC68T-13475-00	271
688-45331-00-94	REC688-45331-00-94	371-373-388-390-391	689-45113-A1	REC689-45113-A0	229	68T-24251-00	REC68T-24251-00	64-65-80-81-82
688-45341-00	REC688-45341-00	295-359-375	689-45501-10	REC689-45501-10	353-388-389	68T-24251-01	REC68T-24251-01	80
688-45341-00-00	REC688-45341-00	373	689-45551-00	REC689-45551-00	353-388-389	68T-24410-00	REC68T-24410-00-00	85
688-45341-10	REC688-45341-00	299-303-307-311-315-319-323-327-331-335-337-341-355-361-363-369-370-379	689-45560-00	REC689-45560-00	353-388-389	68T-24410-01	REC68T-24410-00-00	85
688-45371-02	CM688-45371-02	371	689-45611-00	REC689-45611-00	295-353-355-357-405	68T-44323-00	REC68T-44323-00	149-154-289-293
688-45371-02	CM688-45371-02	160-169	689-81800-10	PH130-0049	110	68T-44352-00	CEF500368	143
688-45371-02	TEN01104	164-169	689-81800-11	PH130-0049	110	68T-44366-00	REC68T-44366-00	143-154-289
688-45371-02	TEN01104AL	164-169	689-81800-12	PH130-0049	110	68T-45251-00	CM68T-45251-00	158-169
688-45371-02-00	CM688-45371-02	373	689-81800-13	PH130-0049	110	68T-45251-00A	CM68T-45251-00A	64-65-158-169-289
688-45375-00	REC688-45375-00	329-371	689-85540-20	REC689-85540-21	119	68T-45251-00	TEN01142	163-169
688-45383-02	REC688-45383-01	315-319-323-371-375	689-85540-21	REC689-85540-21	119	68T-46241-00	REC68T-46241-00	267
688-45383-02-00	REC688-45383-01	373	689-W0001-20	REC689-W0001-20	145	68T-85540-00	REC68T-85540-00	118
688-45384-00	REC688-45384-00	371-375	689-W0001-21	REC689-W0001-21	145-353	68T-W0001-20	REC68T-W0001-20	144-289
688-45384-00-00	REC688-45384-00	373	689-W0078-A6	REC689-W0078-A6	151-155-353	68T-W0078-00	REC68T-W0078-00	150-289
688-45384-02	REC688-45384-00	315-319-323	689-W0093-02	REC689-W0093-02	95	68T-W0078-01	REC68T-W0078-01	64-65-150-154
688-45501-10	REC688-45501-10	390-391	689-W4432-02	REC689-W4432-01	155-156-353	68V-11325-01	CM68V-11325-01	158
688-45501-11	REC688-45501-11	371-390-391	68D-11351-A0	PAF4-04000002	177-270	68V-11325-01A	CM68V-11325-01A	158
688-45536-01	REC688-45536-01	317-321	68D-24610-10	PAF4-04120100	75	68V-11325-01	TEN01156-1	167
688-45551-01	REC688-45551-01	371-390-391	68D-65300-03-4D	PAF4-03100000S	277	68V-11325-01	TEN01156-1AL	167
688-45551-01-00	REC688-45551-00	373	68D-65300-11-4D	PAF4-0310000L	277	68V-11325-02	CM68V-11325-01A	209
688-45560-00	REC688-45560-00	371-390-391	68D-E1111-10-1S	PAF4-04080101	175	68V-11325-02	TEN01156	72-167
688-45560-00-00	REC688-45560-00	373	68D-E1168-00	PAF4-04000010	177	68V-11325-02	TEN01156AL	72-167
688-45567-01	PAT85-040000004-B	315-319	68D-E1169-A0	PAF4-04000009	177	68V-11351-00	REC68V-11351-00	209-218
688-45571-01	REC688-45570-00	371	68D-E1193-A0	PAF4-04000017	175	68V-12111-00	REC68V-12111-00	209
688-45571-01	REC688-45571-00-00	390-391	68D-E1311-02-15	PAF4-04010100	177	68V-13761-00	REC68V-8A360-00	89
688-45587-01	PAT85-040000003-B	317-321	68D-E1325-00	PAF4-04070003	64-65-66-67-68-69-70-71-173-175-179	68V-13761-01	REC68V-13761-01	90
688-45611-00	REC688-45611-00	371-390-391	68D-E1603-00	REC68D-E1603-00	175-219	68V-13907-00	REC68V-13907-00	86
688-45631-01	REC688-45631-00	371-390-391	68D-E1631-00-96	PAF4-04020001	175	68V-13907-01	REC68V-13907-01	86
688-45633-00	REC688-45633-00	373	68D-E1631-00-96	PAF4-04020200	175-219	68V-13907-02	REC68V-13907-02	86
688-45634-00	REC688-45634-00	371	68D-E1633-00	PAF4-04020005	175-219	68V-13907-03	REC68V-13907-03	86
688-45635-00	REC688-45635-00	369-371	68D-E2113-00	PAF4-04020008	173-175	68V-13907-04	REC68V-13907-04	86
688-45930-02-98	SOL3431-133-17	402	68D-E2155-00	PAF4-04080009	175	68V-13915-00	REC68V-13915-00	72-82
688-45970-03-98	SOL3431-130-19	402	68D-E2170-00	PAF4-04040000	175	68V-14984-00	REC68V-14984-00	72-86-88
688-45972-02-98	SOL3431-130-21	402	68D-E2413-00-1S	PAF4-04070000	179	68V-15312-00	REC68V-15312-00	272
688-45978-60-98	SOL3431-135-15	402	68D-E2413-001S	PAF4-04070100	175	68V-24410-00	REC68V-24410-00	85
688-45987-01	REC688-45987-00	315-319-371-405	68D-E2414-A0	PAF4-04000011	175	68V-24563-00	REC68V-24563-00	68-80-81-82
688-45987-01-00	REC688-45987-00	373	68D-E3102-00	PAF4-04050100	177	68V-43880-03-40	REC18-6865	124
688-45997-00	REC688-45997-00	383	68D-E5111-00-1S	PAF4-04050200	177	68V-43880-03-40	REC63P-43880-20	124
688-45997-01	REC688-45997-00	323-327-331-335-337-375-379-405	6					



R.O. / OEM	REF		R.O. / OEM	REF		R.O. / OEM	REF	
68V-W0001-20	REC68V-W0001-20	147-322	69J-45300-22-8D	REC421-B25F	331	6A0-24410-02	REC6A0-24410-04	85
68V-W0078-00	REC68V-W0078-00	70-71-152-155-322	69J-45300-32-8D	REC421-B30F	279	6A0-24410-03	REC692-24410-00	85
68W-43880-03	PH200-T057	123	69J-45361-00-8D	REC69J-45361-00-8D	331-383	6A0-24410-03	REC6A0-24410-04	85
692-14590-00	REC692-14590-01	98	69J-45375-00	REC69J-45375-00	331-383	6A0-24410-04	REC692-24410-00	85
692-14590-01	REC692-14590-01	98	69J-45611-00	REC69J-45611-00	331-337-392	6A0-24410-04	REC6A0-24410-04	85
692-14923-00	REC692-14923-00	98	69J-45631-00	REC69J-45631-00	331-337-392	6A0-24410-05	REC692-24410-00	85
692-24410-00	REC692-24410-00	85	69J-46241-00	REC69J-46241-00	267	6A0-82550-01	REC6A0-82550-01	120
692-24411-00	REC692-24411-00	87	69J-81800-00	PH130-0074	112	6A0-W0001-21	REC6A0-W0001-21	146
692-26301-00	REC692-26301-03	129	69J-81800-01	PH130-0074	112	6A1-14301-03	REC6A1-14301-03	92-93
692-26301-01	REC692-26301-03	129	69J-81960-10	REC69J-81960-13	116	6A1-14613-00	REC6A1-14613-A0	270
692-26301-02	REC692-26301-03	129	69J-81960-11	REC69J-81960-13	116	6A1-14613-01	REC6A1-14613-A0	270
692-26301-03	REC692-26301-03	129	69J-81960-12	REC69J-81960-13	116	6A1-14613-A0	REC6A1-14613-A0	220-270
692-41256-00	REC692-41256-00	101	69J-81960-13	REC69J-81960-13	116	6A1-44325-00P	REC6A1-44325-00	343
692-44120-21	REC692-44120-22	134	69J-85885-00	REC69J-85885-00	90-102	6A1-44361-00	REC6A1-44361-00	343
692-44120-22	REC692-44120-22	134	69J-W0001-20	REC64J-W0001-20	146-333	6A1-85540-01	REC6A1-85540-01	118
692-45300-12-4D	REC692-45300-16-8D	280	69J-W0001-20	REC69J-W0001-20-00	147	6A1-85540-01	REC6A1-85540-01	118
692-45300-13-4D	REC692-45300-16-8D	280	69K-45300-21-8D	REC428-B25F	279	6A1-85570-00	REC6A1-85570-00	105
692-45300-14-4D	REC692-45300-16-8D	280-370	69K-45300-34-8D	REC428-B30F	279	6A1-W0001-22	REC6A1-W0001-22	144
692-W0078-00	REC692-W0078-02	152	69K-45611-00	REC69K-45611-00	331-337	6A1-W0001-23	REC6A1-W0001-23	144-343
692-W0078-00-00	REC692-W0078-02	373	69L-11181-00	REC61A-11181-A0	249-254	6A1-W0078-01	REC6A1-W0078-01	150-155-343
692-W0078-01	REC692-W0078-02	152	69L-11635-00-85	REC69L-11631-00K	267	6A1-W0093-01	REC6A1-W0093-01	93-95
692-W0078-01-00	REC692-W0078-02	373	69L-11642-00-85	REC69L-11642-00	267	6AE-43880-00	PH200-T057	123
692-W0078-02	REC692-W0078-02	152-156-370	69L-45371-00	CM69L-45371-00	160-169	6AE-43880-01	PH200-T057	123
695-11181-A1	REC695-11181-00	248-254	69L-45371-00	CM69L-45371-00A	160-169	6AE-43880-03	PH200-T057	123
695-85540-11	REC695-85540-11	119	69L-45371-00	TEN01145	168-169	6AE-43880-04	PH200-T057	123
695-85540-12	REC695-85540-11	119	69L-81800-00	PH130-0059	110	6AG-11181-00	REC6AG-11181-00	215
695-W0001-01	REC695-W0001-A2	250-254	69M-11181-00	PAF2.6-04000001	173-215-218	6AG-11181-10	REC6AG-11181-00	187-218
696-14590-01	REC696-14590-01	98	69M-11193-A0	PAF2.6-04000005	173	6AH-11111-10-1S	PAF20-05030100	187
696-45113-00	REC696-45113-00	239	69M-11351-A0	PAF2.6-04000004	171-270	6AH-11168-00	PAF20-05040003	187
696-45113-A0	REC696-45113-00	253-254	69M-11400-00	PAF2.6-04000000	173-219	6AH-11169-00	PAF20-05040004	187
696-85540-10	REC696-85540-12	119	69M-11650-00	PAF2.6-04020100	173	6AH-11191-001S	PAF20-05040000	187
696-85540-11	REC696-85540-12	119	69M-12154-00	PAF2.6-04000002	173	6AH-11351-10	REC6AH-11351-10	187-218
696-85540-12	REC696-85540-12	119	69M-12170-01	PAF2.6-04000100	173	6AH-11356-00	PAF20-05040002	187
696-W0093-00	REC696-W0093-00	239	69M-12411-00	REC6AH-12411-00	136	6AH-11372-00	PAF20-05040005	187
696-W0093-01	REC84419M	96	69M-12411-01	REC6AH-12411-01	136-173-175	6AH-11411-00	PAF20-05020004	189-219
696-W0093-02	REC696-W0093-00	96	69M-14301-21	PAF2.6-04000200	91	6AH-11416-00	PAF20-05010003	189
696-W0093-02	REC84419M	96	69M-15361-00	PAF2.6-04010102	171	6AH-11536-00	PAF20-05000027	189
697-11181-A2	REC697-11181-A1	239-249-254	69M-24575-00	PAF2.6-00000004	76	6AH-11537-00	PAF20-05030012	189
697-44352-00	REC6H3-44352-00	369	69M-44361-00	PAF2.6-02000003S	283	6AH-11557-00	PAF20-05000028	189
697-45114-A0	REC697-45114-00	254-271	69M-44361-10	PAF2.6-02000003L	283	6AH-11603-00	PAF20-05020100	189-219
697-45384-00	REC697-45384-00	359-365-369	69M-45113-A0	PAF2.6-00000003	173-217-218	6AH-11631-00	PAF20-05020001	189-219
697-45551-00	REC697-45551-00	369-390	69M-65300-01-4D	PAF2.6-03020000S	277	6AH-11650-10	PAF20-05020200	189
697-45560-00	REC697-45560-00	369-390	69M-65300-11-4D	PAF2.6-03020000L	277	6AH-11654-00	PAF25-05020204	189
697-45571-00	REC697-45570-00	369	69M-85640-00	PAF2.6-04000600	106	6AH-12111-00	PAF20-05030001	189
697-45571-00-00	REC697-45571-00-00	390	69M-E1111-00-1S	PAF2.6-040040100	173	6AH-12121-10	PAF20-05030002	189
697-45611-00	REC697-45611-00	369-388-390	69M-E1191-00-1S	PAF2.6-04000006	173	6AH-12151-00	PAF20-05030301	189
697-81800-10	PH130-0007	111	69M-E1311-00-1	PAF2.6-04010100	171	6AH-12170-00	PAF20-05030200	189
697-81800-11	PH130-0007	111	69M-E1603-01	REC69M-E1603-01	173-219	6AH-12279-00	PAF20-05030008	189
697-81800-12	PH130-0007	111	69M-E1631-01-96	PAF2.6-04020001	173-219	6AH-12411-00	REC6AH-12411-00	65-136-137-187
697-85570-00	REC697-85570-00	105	69M-E1633-00	PAF2.6-04020005	173-219	6AH-12413-00-1S	PAF20-05000700	187
697-85570-11	REC697-85570-10	105	69M-E2155-00	PAF2.6-04040001	173	6AH-12414-00	PAF20-05000702	65-138-187
697-W0001-02	REC697-W0001-02	239	69M-E2413-00-1S	PAF2.6-04000501	173	6AH-12481-00	PAF20-05000116	187
697-W0001-A0	REC697-W0001-02	251-254	69M-E3102-00	PAF2.6-04050100	171	6AH-13300-00	PAF20-05030400	189
698-W0001-21	REC698-W0001-21	145-368	69M-E5111-00-1S	PAF2.6-04050001	171	6AH-13329-00	REC6AH-13329-00	271
69D-45501-10	REC69D-45501-10	390	69M-E5363-00	PAF15-07050004	171-180	6AH-13329-01	PAF20-05030010	189
69D-W0001-20	REC69D-W0001-20	146	69M-E5396-00	PAF2.6-04060001	171	6AH-15100-00	PAF20-05010000	187
69G-45315-A0	PAF20-04000001	292	69M-E5396-00-5B	PAF2.6-04060000	171	6AH-15312-00	REC6AH-15312-00	271
69G-45331-01-CA	PAF20-04010001	292	69M-G2743-00	PAF2.6-04000008	171	6AH-24410-00	PAF20-05050000	85
69G-45510-10	REC69G-45510-10	387	69M-G4311-00	PAF2.6-03000014	147-154-283	6AH-41113-01-1S	PAF20-05000600	187
69G-45510-20	REC69G-45510-20	387	69M-G4323-00	PAF2.6-03000010	148-154-283	6AH-41114-00	PAF20-05000602	187
69G-W0001-20	REC69G-W0001-20	144-289	69M-G4328-00	PAF2.6-03000016	283	6AH-44150-00	PAF20-04020000S	292
69G-W0078-00	REC69G-W0078-01	150	69M-G5300-00-4D	PAF2.6-03020000S	283	6AH-44150-10	PAF20-04020000L	292
69G-W0078-01	REC69G-W0078-01	150	69M-G5300-01-4D	PAF2.6-03020000L	283	6AH-44311-00	PAF20-04040001	147-293
69J-11181-03	REC69J-11181-03	216-218	69M-G5311-00-4D	PAF2.6-03000001	283	6AH-44361-01	PAF20-02000101S	293
69J-11182-03	REC69J-11182-03	216-218	69M-G5315-A0	PAF2.6-03000007	283	6AH-44361-11	PAF20-02000101L	293
69J-11351-11	REC69J-11351-11	213-218	69M-G5321-00-9A	PAF2.6-03000008	283	6AH-44365-00	PAF20-02000007	293
69J-12111-00	REC69J-12111-00	211	69M-G5361-00-4D	PAF2.6-03000300	283	6AH-44368-00	PAF20-02000005	293
69J-12119-00	REC69J-12119-00	211	69M-G5361-00-4D	PAF2.6-03000301	283	6AH-45251-00	TEN01154	169
69J-13440-00	REC35-822626Q15	83	69M-G5511-00	PAF2.6-0300011S	283	6AH-45251-00	TEN01154L	65-165
69J-13440-01	REC35-822626Q15	83-211-213	69M-G5511-10	PAF2.6-0300011L	283	6AH-45300-00-4D	PAF20-04000000S	277
69J-13440-03	REC35-822626Q15	71-72-73-83	69M-G5635-00	PAF2.6-03000200	283	6AH-45300-00-8D	PAF20-04000000L	277-292
69J-13645-A1	REC69J-13645-00	273	69M-WE0090-01-1S	POWERHEAD2.6	173	6AH-45300-10-4D	PAF20-04000000L	277
69J-13761-00	REC69J-13761-00	90	69P-11412-00	REC6G0-11412-00	229-256	6AH-45300-10-8D	PAF20-04000000L	277-292
69J-13906-00	REC69J-13906-00	89-90	69P-11422-00	REC6G0-11422-00	229-256	6AH-45510-00	PAF20-04030000S	293
69J-13907-00	REC69J-13907-03	86	69P-11432-00	REC6G0-11432-00	229-256	6AH-45510-10	PAF20-04030000L	293
69J-13907-01	REC69J-13907-03	86	69P-11442-00	REC6G0-11442-00	229-256	6AH-46241-00	PAF20-05000003	189-267
69J-13907-02	REC69J-13907-03	86	69P-85541-09	REC69P-85541-09	106	6AH-81800-00	PAF20-0500900W	111
69J-13907-03	REC69J-13907-03	86	69W-43880-00	PH200-T036	122	6AH-81800-01	PAF20-0500900W	111
69J-13907-04	REC69J-13907-03	86	69W-43880-01	PH200-T036	122	6AH-81960-00	PAT85-05030300	116
69J-15451-00	REC69J-15451-00	213	69W-45300-00-4D	PAF60-04000000	278	6AH-82560-00	PAT40-05000100	103
69J-15451-A1	REC69J-15451-00	273	69W-45300-00-8D	PAF60-04000000	278	6AH-85510-00	PAF20-05000200	121
69J-24410-00	REC69J-24410-02	86	69W-45300-01-8D	PAF60-04000000	278	6AH-85540-00	PAF20-05000300	118
69J-24410-01	REC69J-24410-02	86	69W-45300-04-8D	PAF60-04000000	311	6AH-85550-00	PAF20-05	

R.O. / OEM	REF		R.O. / OEM	REF		R.O. / OEM	REF	
6AW-11182-00	REC6AW-11182-00	214-216-218	6C5-12858-00	PAF15-07010003	187	6E0-45251-11	CM6E0-45251-11	169
6AW-11325-00	TEN01170	214	6C5-13761-00	REC6C5-13761-00	89-90	6E0-45251-11-00	CM6E0-45251-11	158
6AW-11325-00	TEN01170	167	6C5-13907-00	REC866169T01	86	6E0-45251-11-00	CM6E0-45251-11A	65-66-67-68-69-158-169
6AW-11325-00	TEN01170	73-169	6C5-13915-00	REC6C5-13915-00	68-69-70-81	6E0-45251-11-00	TEN01123	164-169
6AW-1132L-00	TEN01173	73-167-169	6C5-14984-00	REC6C5-14984-00	68-69-86-88	6E0-45251-11-00	TEN01123AL	164-169
6AW-1132M-00	TEN01176	167-169	6C5-24251-00	REC6C5-24251-00	67-68-69-70-80	6E0-45315-A0	PAF4-03000011	345
6AW-1132P-00	TEN01177	73-168-169-214	6C5-24410-00	REC6C5-24410-00	85	6E0-45316-09	PAF4-03000003	285-287
6AW-1132R-00	TEN01172	73-167-169-214	6C5-43800-11	PAF60-06000000	124	6E0-45316-09	PAF4-03000016-00	345
6AW-1132T-00	TEN01175	73-167-169	6C5-43800-12	PAF60-06000000	124	6E0-45316-09	REC90340-08002	346
6AW-1132U-00	TEN01174	73-167	6C5-43880-00	PH200-T045	123	6E0-45317-09	PAF4-03000002	285-287
6AW-11351-00	REC6AW-11351-00	214-218	6C5-43880-01	PH200-T045	123	6E0-45317-09	REC6E0-45317-00	345
6AW-12411-00	REC6AW-12411-00	73-137-214	6C5-44361-00	PAF60-02000007	313	6E0-45321-01-5B	PAF4-03000012	345
6AW-13907-00	REC6AW-13907-00	86	6C5-46241-00	REC6C5-46241-00	195-201-203-205-267	6E0-45361-01-4D	PAF4-03050001	345-387
6AW-14613-00	REC6AW-14613-00	272	6C5-81800-00	PH130-0056	111	6E0-45511-01	REC6E0-45511-01	285
6AW-14623-00	REC6AW-14623-00	272	6C5-82105-01	PAT85-05000023	112	6E0-45511-01	REC6E0-45511-01	345-387
6AW-14984-00	REC6AW-14984-00	73-88	6C5-85885-00	REC6C5-85885-00	90-102	6E0-45511-11	PAF4-03000004L	285
6AW-15312-00	REC6AW-15312-00	272	6C9-81800-00	PH130-0076	112	6E0-45511-11	REC6E0-45511-11	345-387
6AW-15451-00	REC6AW-15451-00	214-272	6CB-11181-00	REC6CB-11181-00	216-218	6E0-45551-00	PAF4-03000007	285
6AW-41134-00	REC6AW-41134-01	270	6CB-13016-00	REC6CB-13016-00	70-71-72-73-88	6E0-45551-00	REC6E0-45551-00	345-387
6AW-4380R-00	REC48630-96J03	125	6CB-14984-00	REC6CB-14984-00	70-71-72-73-88	6E0-45560-00	REC6E0-45560-00	345-387
6AW-4380R-01	REC48630-92J00	125	6CB-24501-01	REC6CB-24501-01	70-72-73	6E0-45570-00	REC6E0-45570-00	345-387
6AW-43880-00	REC6AW-43880-02	123	6CB-45611-00	REC6CB-45611-00	335	6E0-45611-01	REC6E0-45611-01	345
6AW-43880-01	REC6AW-43880-02	123	6CE-12411-00	REC6CE-12411-00	73-137	6E0-45631-00	REC6E0-45631-00	345-387
6AW-43880-02	REC6AW-43880-02	123	6CE-44311-00	REC6CE-44311-01	148	6E0-45943-01	PAF4-03070000	287
6AW-44311-00	REC6AW-44311-01	148-341	6CE-44311-01	REC6CE-44311-01	148-335	6E0-45943-01-EL	PAF4-03070000	285-402
6AW-44311-01	REC6AW-44311-01	148	6CE-44315-00	REC6CE-44315-00	335	6E0-45943-01-EL	SOL3011-075-07S	402
6AW-44312-00	REC6AW-44312-00	335-341	6CE-44323-01	REC6CE-44323-01	335	6E0-45949-00	PAF2.6-03010000	287
6AW-44315-00	REC6AW-44315-00	341	6CE-44352-00	CEF500401N	143	6E0-85540-70	REC6E0-85540-71	119
6AW-44322-00	REC6AW-44322-00	335-341	6CE-44352-01	REC6CE-44352-00	155-335	6E0-85540-70	REC6E0-85540-71	119
6AW-44323-00	REC6AW-44323-00	341	6CE-W0078-00	REC6CE-W0078-01	153	6E0-85570-00	REC6E0-85570-00	104
6AW-44336-00	REC6AW-44336-00	341	6CE-W0078-01	REC6CE-W0078-01	73-153-334	6E0-W0001-C1	REC6E0-W0001-C1	144-285-345
6AW-44352-00	CEF500389N	143-155	6CJ-11181-00	REC6CJ-11181-00	205-215-218	6E0-W0078-00	PAGB/T820-M5X30	345
6AW-44352-00	REC6AW-44352-00	143-341	6CJ-44323-00	REC6CJ-44323-00	317	6E0-W0078-01	PAGB/T820-M5X30	345
6AW-44365-00	REC6AW-44365-00	335-341	6CJ-44324-00	REC6CJ-44324-00	317	6E0-W0078-02	PAGB/T820-M5X30	345
6AW-45113-00	REC6AW-45113-00	272	6CJ-81800-00	PH130-0056	111	6E0-W0078-02	REC6E0-W0078-02	150-153
6AW-45251	TEN01112-1	166-169	6CJ-W0078-00	REC6CJ-W0078-00	69-151-153-154-314	6E0-W0078-A2	REC6E0-W0078-A2	150-153-155-285-345
6AW-45251-00	CM6AW-45251-00	161-169	6D0-11181-00	REC6D0-11181-00	249-254	6E3-14301-05	REC6E3-14301-05	92-93
6AW-45251-00A	CM6AW-45251-00A	72-161-169	6D0-41134-00	REC6D0-41134-00	272	6E5-11181-A2	REC6E5-11181-A0	245-249-254
6AW-45373-00	CM6AW-45373-00	161-169	6D0-44362-01	REC6D0-44362-01	335-339	6E5-11193-A0	REC6E5-11193-A0	245-255
6AW-45373-00A	CM6AW-45373-00A	161-169-341	6D0-44367-00	REC6D0-44367-00	335-339	6E5-11325-00	CM15026	158-169
6AW-45373-00	TEN01155	166-169	6D0-45332-00-CA	REC6D0-45332-00-CA	337	6E5-11325-00	CM15026A	65-70-72-73-158-169-187-209-213
6AW-45373-00	TEN01155AL	166-169	6D0-45361-00-8D	REC6D0-45361-00-8D	337	6E5-11325-00	PAF15-07010026	183
6AW-45619-00	CM6AW-45619-00	161	6D0-81800-00	PH130-0076	112	6E5-11325-00	TEN01152	163-169-245-247
6AW-45619-00A	CM6AW-45619-00A	161-341	6D0-W0001-00	REC6D0-W0001-00	252-254	6E5-11381-A1	REC6E5-11381-A1	275
6AW-45619-00	TEN01169	165	6D3-81960-00	REC881346T	117	6E5-11381-A2	REC6E5-11381-A1	245-247
6AW-8194A-00	REC6AW-8194A-00	115	6D8-11603-01	REC6D8-11603-10	209	6E5-11411-00	REC6E5-11411-00	256
6AW-81950-00	REC6AW-81950-00	115	6D8-11604-01	REC6D8-11604-10	209	6E5-11447-00	REC6E5-11447-00	245-247
6AW-W0078-00	REC6AW-W0078-00	73-153-155-341	6D8-12121-10	REC6D8-12121-10	209	6E5-11610-02	REC6E5-11610-02	265-266-267
6B4-11193-A0	REC6B4-11193-A0	140	6D8-13761-00	REC6D8-13761-00	89-90	6E5-11633-01	REC6E5-11633-00	261-265
6B4-11351-A1	REC6B4-11351-A1	252	6D8-24563-00	REC6D8-WS24A-00	80	6E5-11634-00	REC6E5-11634-00	265
6B4-14301-00	REC6B4-14301-00	91-93	6D8-41114-A0	REC67F-41114-A2	209	6E5-11650-01	REC6E5-11650-01	261
6B4-26301-00	REC6B4-26301-00	129	6D8-43880-00	PH200-T068	123	6E5-11651-00	REC6E5-11651-00	261
6B4-45251-00	TEN01116	169-348	6D8-43880-01	REC6D8-43880-09	123	6E5-12411-00	REC6E5-12411-02	136
6B4-85520-00	REC6B4-85520-00	107	6D8-43880-09	PH200-T068	123	6E5-12411-01	REC6E5-12411-02	136-221-223-229-231-233
6B4-85540-01	REC6B4-85540-01	120	6D8-44341-01	REC6D8-44341-01	321	6E5-12411-02	REC6E5-12411-02	136-137
6B4-85570-00	REC6B4-85570-01	104	6D8-WS24A-00	REC6D8-WS24A-00	80	6E5-12411-20	REC6E5-12411-30	137
6B4-85570-01	REC6B4-85570-01	104	6D9-12411-00	REC6D9-12411-00	66-67-68-69-70-71-81	6E5-12411-30	REC6E5-12411-30	137-227-237-245-247
6B4-85580-00	REC6B4-85580-00	107	6D9-45551-00	REC6D9-45551-00	70-137	6E5-13411-00	REC6E5-13411-00	83
6BG-11181-00	REC6BG-11181-00	201-215-218	6DA-11181-00	REC6DA-11181-00	216-218	6E5-13621-A1	REC6E5-13621-A1	275
6BG-13761-00	REC6BG-13761-00	89-90	6DA-12411-01	REC6DA-12411-01	72-136-137	6E5-13645-A1	REC6E5-13645-A1-00	275
6BG-13915-00	REC6BG-13915-00	67-80	6DA-13761-00	REC6DA-13761-00	90	6E5-14198-A2	REC6E5-14198-A2	275
6BG-44341-00	PAT40-04040001	313	6E0-11193-A1	REC6E0-11193-A1	221	6E5-14323-03	REC6E5-14323-03	99
6BG-W0078-00	REC6BG-W0078-00	67-151-153-154-302	6E0-11631-00-98	REC6E0-11631-00-98K	221-262-266	6E5-14328-01	REC6E5-14328-01	99
6BL-11181-00	REC6BL-11181-00	195-215-218	6E0-11651-01	REC6E0-11651-01	221-225-260	6E5-14385-02	REC6E5-14385-02	93-100
6BL-11325-00	CM6BL-11325-00	161	6E0-24411-00	REC6E0-24411-00	87	6E5-14386-01	REC6E5-14386-01	99
6BL-11325-00	CM6BL-11325-00A	161-195	6E0-24435-00	REC6E0-24435-00	87	6E5-14386-02	REC6E5-14386-02	99
6BL-11325-00	TEN01161	166	6E0-24471-00	REC6E0-24471-00	87	6E5-14416-A1	REC6E5-14416-A1	275
6BL-44391-00	PAF15-05000009	139	6E0-26301-01	REC6E0-26301-01	129	6E5-14483-A1	REC6E5-14483-A1	275
6BR-81800-00	PH130-0073	112	6E0-41112-A1	REC6E0-41112-A1	140-21	6E5-14546-00	REC6E5-14546-00	93-98
6BR-81800-01	PH130-0073	112	6E0-41114-A1	REC6E0-41114-A1	140-221	6E5-24305-05-00	GS31076	76
6BX-11181-00	PAF6-04000002	179-215	6E0-43118-00	REC6E0-43118-00	134	6E5-24305-06-00	GS31076	76
6BX-11351-00	PAF6-04000001	179	6E0-43118-01	REC6E0-43118-01	134	6E5-24351-00	REC6E5-24351-00	75
6BX-11356-00	PAF6-04000005	179	6E0-44311-00	PAF4-03000019	154-345	6E5-24351-51	REC6E5-24351-51	75
6BX-12111-00	PAF6-04050001	179	6E0-44315-A0	PAF4-03000018	345	6E5-24377-00	PAF15-07010006	181-183
6BX-12154-00	PAF6-04000003	179	6E0-44322-02	PAF4-03000017	285	6E5-24410-01-00	REC6E5-24410-03	85
6BX-44322-00	PAF6-03000002	154-287	6E0-44322-02	REC6E0-44322-02	154-155-345	6E5-24411-00-00	REC6E5-24411-00	87
6BX-45113-00	PAF6-00000001	151-179-217	6E0-44322-02	REC6E0-44322-02	154-155-285-	6E5-24434-02	REC6E5-24434-02	88
6BX-E1111-00-1S	PAF6-04050100	179	6E0-44323-00	PAF4-03000015	345	6E5-24435-00	REC6E5-24435-00	88
6BX-E1168-00	PAF6-04010004	179	6E0-44328-00	PAF4-03000020	345	6E5-24471-00	REC6E5-24471-00	87
6BX-E1191-00-5B	PAF6-04000004	179	6E0-44352-00	PAF4-03000000	64-285	6E5-41112-A1	REC6E5-41112-A1	142-245
6BX-E2155-00	PAF6-04050004	179	6E0-44366-00	PAF4-03000000	143	6E5-41134-A0	REC6E5-41134-A0	269-270
6BX-E2170-00	PAF6-04030000	179	6E0-45113-A1	REC6E0-45113-A1	221-252	6E5-43880-01	PH200-T037	123
6BX-F4323-00	PAF6-04000020	179				6E5-43880-02	PH200-T037	123
6BX-G4150-00	PAF4-03020000S							



R.O. / OEM	REF		R.O. / OEM	REF		R.O. / OEM	REF	
6E5-44150-01	REC6E5-44150-02	377	6E5-85540-12	REC6E5-85540-12	119	6F5-14390-21	REC6F5-14390-21	98
6E5-44311-00	REC61A-44311-00	148	6E5-85570-10	REC6E5-85570-11	105	6F5-14398-00	REC6F5-14398-00	94
6E5-44311-00	REC6E5-44311-00	155-156-157-381	6E5-85570-11	REC6E5-85570-11	105	6F5-14483-00	REC6F5-14483-00	94
6E5-44312-00	REC6E5-44312-00	325-329-333-339-385-386	6E5-W0001-A2	REC6E5-W0001-A2	251	6F5-15396-01-5B	REC6F5-15396-01-5B	235
6E5-44315-A0	REC6E5-44315-A0	156-157-325-329-333-377-381-385	6E5-W0001-A2	REC6E5-W0001-A2	254	6F5-15713-00	REC66T-15713-00	112
6E5-44322-00	REC6E5-44322-00	156-157-381	6E5-W0001-F1	REC6E5-W0001-F1	147-374-378	6F5-15713-01	REC66T-15713-01	112
6E5-44323-00	REC6E5-44323-00-40	149-155-156-157-377	6E5-W0078-02	REC6E5-W0078-02	374	6F5-24563-00	REC6F5-24563-00	80-81-82
6E5-44352-01	CEF500371	143	6E5-W0093-06	REC6E5-W0093-06	97-245	6F5-26311-00	REC6F5-26311-00	129
6E5-44352-01	REC6E5-44352-01	143-155-156-157-325-329-333-339-377-381-385-386	6E5-W0093-07	REC6E5-W0093-07	97	6F5-41111-01-1S	REC6F5-41111-01-1S	235
6E5-44365-00	REC6E5-44365-00	155-157-325-329-333-339-377-381-385-386	6E5-W0093-08	REC6E5-W0093-08	97	6F5-41112-A0	REC6F5-41112-A0	141-235
6E5-44366-00	REC6E5-44366-00	155-156-157-325-333-339-377-381	6E7-11111-01-1S	REC6E7-11111-01-1S	227	6F5-41113-01-1S	REC6F5-41113-01-1S	235
6E5-45113-A0	REC6E5-45113-A2	253-254	6E7-11181-A2	REC6E7-11181-A2	248-254	6F5-41114-A0	REC6F5-41114-A0	142-235
6E5-45114-A0	REC6E5-45114-00	272	6E7-11631-00	REC6E7-11631-00K	262	6F5-44352-00	CEF500352	143
6E5-45251-00	CM6E5-45251-00	158-169	6E7-11631-00-97	REC6E7-11631-00K	227-266	6F5-44352-02	REC6F5-44352-02	156-367
6E5-45251-00	TEN01105	164-169	6E7-11635-00	REC6E7-11635-00K	227-262	6F5-45113-A0	REC6F5-45113-A0	235-253-254
6E5-45251-00	TEN01129	165	6E7-11636-00	REC6E7-11636-00K	227-262	6F5-45312-01-4D	REC6F5-45312-00-4D	363
6E5-45300-16-8D	REC405-A20	375	6E7-14227-00	REC6E7-14227-00	94	6F5-45551-00	REC6F5-45551-00	363-389-390
6E5-45300-17-8D	REC405-A20	280	6E7-14385-00	REC6E7-14385-00	93-100	6F5-45560-00	REC6F5-45560-00	363-389-390
6E5-45300-26-8D	REC405-A25	375	6E7-44366-00	REC6E7-44366-00	349	6F5-45570-00	REC6F5-45570-00	363-389-390
6E5-45300-27-8D	REC405-A25	280	6E7-45331-00-9M	REC6E7-45331-00-CA	349	6F5-81800-10	PH130-0062	110
6E5-45321-00	REC6E5-45321-00	325-329-377-381	6E7-45501-00	REC6E7-45501-00	349	6F5-81800-11	PH130-0062	110
6E5-45331-00-94	REC6E5-45331-00-94	377-381	6E7-45501-10	REC6E7-45501-11	349-387-388	6F5-85540-22	REC6F5-85540-22	119
6E5-45331-00-9S	REC6E5-45331-00-94	325-329	6E7-45536-00	REC6E7-45536-00	349	6F5-W0001-C0	REC6F5-W0001-C0	145-363
6E5-45331-00-9S	REC6E5-45331-00-94	391	6E7-45551-00	REC6E7-45551-00	348-387-388	6F5-W0078-00	REC6F5-W0078-A0	151
6E5-45332-00-94	REC6E5-45332-00-94	375	6E7-45560-00	REC6E7-45560-01	291-293-351-387-388	6F5-W0078-A0	REC6F5-W0078-A0	156-363
6E5-45332-00-CA	REC6E5-45332-00-94	323	6E7-45570-00	REC6E7-45570-00	293	6F6-11111-00-1S	REC6F6-11111-00-1S	235
6E5-45344-00	REC6E5-45344-00	325-329-333-339-377-381-385	6E7-45571-00	REC6E7-45571-00	291-349-351-387-388	6F6-11191-00-1S	REC6F6-11191-00-1S	235
6E5-45371-00	CM6E5-45371-01A	323	6E7-45587-01-30	PAF15-06000009	348	6F6-11193-A1	REC6F6-11193-A1	235-255
6E5-45371-00	TEN01153	164	6E7-45987-00	REC6E7-45987-00	291-349	6F6-11400-01	REC6F6-11400-02	235
6E5-45371-01	CM6E5-45371-01A	161-379	6E7-45987-01	PAF15-06000015	351	6F6-11610-010	REC6F5-11610-10	235
6E5-45371-01	REC6E5-45371-01	161-169-375	6E7-45987-01	REC6E7-45987-00	293-351-405	6F6-11610-20	REC6F5-11610-20	235
6E5-45371-10	CM6E5-45371-10	160	6E7-85570-19-00	REC6E7-85570-19	106	6F6-11631-00-95	REC6F6-11631-00K	235-263
6E5-45371-10	TEN01153	370-375	6E7-W0001-00	REC6E7-W0001-A1	249	6F6-11635-00	REC6F6-11635-00K	235-263
6E5-45501-01	REC6E5-45501-01	377-391	6E7-W0001-A1	REC6E7-W0001-A1	249-254	6F6-11636-00	REC6F6-11636-00K	235-263
6E5-45536-00	REC6E5-45536-00	325-377	6E7-W0093-04	REC6E7-W0093-01	95	6F6-13610-00	REC6F6-13610-00	99
6E5-45536-01	REC6E5-45536-00	329	6E8-14390-12	REC6E8-14390-12	98	6F6-14301-06	REC6F6-14301-06	91
6E5-45551-02	REC6E5-45551-00	375-391	6E8-45251-00	CM6E8-45251-00	159	6F6-14341-00	REC6F6-14341-00	98
6E5-45560-01	REC6E5-45560-00	375-391	6E8-45251-00	TEN01106	164	6F6-14385-00	REC6F6-14385-00	100
6E5-45567-01	REC6E5-45567-01	323	6E8-45251-02	CM6E8-45251-01	159-169	6F6-45611-00	REC6F6-45611-00	363-389-390
6E5-45567-01-60	REC6E5-45567-01	375	6E8-45251-02	TEN01116	164	6F6-85530-01	REC6F6-85530-01	106
6E5-45571-01	REC6E5-45570-00	375-391	6E8-45587-10	PAF15-06000008	293	6F6-85540-01	REC6F6-85540-01	118
6E5-45576-00	REC6E5-45576-00	323-375	6E8-45587-10-13	PAF15-06000008	291-351	6F6-W0001-02	REC6F6-W0001-02	234-251
6E5-45587-01	REC6E5-45587-01	325-329-377	6E8-45587-30	PAF15-06000009	293	6F6-W0093-00	REC6F6-W0093-00	96-234
6E5-45611-00	REC6E5-45611-00	323	6E9-11193-A0	REC6E9-11193-A0	255	6F8-11181-A1	REC6F8-11181-A0	220-248-254
6E5-45631-01	REC6E5-45631-00	323-327-335-375-379-391-392	6E9-12413-00-1S	REC6E9-12413-00-1S	139-235	6FM-12411-00	REC6FM-12411-00	66-136-137
6E5-45633-01	REC6E5-45633-01	323-327-335-375-379-391-392	6E9-12414-A1	REC6E9-12414-A1	138-139-235	6FM-13761-00	REC6FM-13761-00	90
6E5-45634-01	REC6E5-45634-01	323-327-375	6E9-14198-A0	REC6E9-14198-A0	275	6FP-12411-00	REC6FP-12411-00	70-137
6E5-45634-02	REC6E5-45634-01	327	6E9-24378-00	PAF4-04010102	187	6G0-11181-00	REC6G0-11681-00	261
6E5-45641-02	REC6E5-45641-03	375	6E9-41114-A0	REC6E9-41114-A0	142	6G0-82519-00	PAF6-04000009	179
6E5-45641-03	REC6E5-45641-03	327-379	6E9-81970-70	REC6G1-81970-62	116	6G0-85540-11	REC6G0-85540-11	119
6E5-45941-00-EL	SOL3411-130-19	402	6E9-82575-00	REC6E9-82575-02	120	6G1-11193-A1	REC6G1-11193-A1	140-223
6E5-45941-00-EL	SOL3413-125-19	402	6E9-W0093-02	REC6E9-W0093-02	96	6G1-11610-00	REC6G1-11610-00	221-262-266
6E5-45943-00-EL	SOL3411-130-21	402	6E9-W0093-03	REC6E9-W0093-03	96	6G1-11633-00	REC6G1-11633-00	221-225-260-262
6E5-45943-00-EL	SOL3413-125-21	402	6EE-E5362-00	PAF4-04000036	177	6G1-11681-00	REC6G1-11681-00	221-223-225-260
6E5-45945-00-EL	SOL3411-133-17	402	6EE-E5396-00-CA	PAF4-04060000	177	6G1-13621-A1	REC6G1-13621-A1	273
6E5-45945-00-EL	SOL3413-128-17	402	6EE-F4251-00	REC6E8-24251-00	80	6G1-13645-A1	REC6G1-13645-A1	273
6E5-45947-00-EL	SOL3411-135-15	402	6EE-G2177-00	PAF4-01090300	134	6G1-14198-A1	REC6G1-14198-A1	273
6E5-45947-00-EL	SOL3413-130-15	402	6EE-G4315-00	PAF4-03000018	64-154	6G1-14301-01	REC6G1-14301-01	91-93
6E5-45949-00-EL	SOL3411-138-13	402	6EE-G4366-00	PAF4-03000021	154-155	6G1-14546-01	REC6G1-14546-00	93-98
6E5-45949-00-EL	SOL3413-133-13	402	6EE-G5987-00	PAF4-03000025	405	6G1-15755-00	PAF4-04130100	113
6E5-45954-00-EL	SOL3411-140-11	402	6EE-W0078-00	REC6EE-W0078-01	150	6G1-15779-00	PAF4-04130100	113
6E5-45978-01	REC6E5-45987-00	379	6EE-W0078-01	REC6EE-W0078-01	150	6G1-24304-02	REC6G1-24304-02	77
6E5-45987-01	REC6E5-45987-00	375-405	6EG-G2138-00	PAF4-01090100	131	6G1-24305-01	GS31075	76
6E5-61301-00	GS41084	130	6EK-13761-00	REC6EK-13761-00	90	6G1-24305-02	GS31075	76
6E5-61301-01	GS41084	130	6EK-4380R-00	REC48630-92J00	125	6G1-24305-02-00	GS31075	76
6E5-81800-10	PH130-0005	110	6EK-44323-00	REC68V-44323-00	149-155-269-325	6G1-24305-03	GS31075	76
6E5-81800-11	PH130-0005	110	6F3-W0001-21	REC6E5-W0001-F1	147	6G1-24305-03-00	GS31075	76
6E5-81800-12	PH130-0005	110	6F3-W0001-A4	REC6F3-W0001-04-00	251	6G1-24305-04	GS31075	76
6E5-81900-01	REC6E5-81900-01	84	6F5-11181-A1	REC6F5-11181-A2	235	6G1-24305-04-00	GS31075	76
6E5-81941-11	REC61A-81941-00	114	6F5-11181-A2	REC6F5-11181-A2	248-254	6G1-24305-05	GS31075	76
6E5-81950-01	PH375-0047	110-115	6F5-11193-A0	REC6G5-11193-A0	247	6G1-24305-05-00	GS31075	76
6E5-81950-01	REC89-825096T01	114	6F5-11515-00	REC6F5-11515-00	233-235	6G1-24305-0500	GS31075	76
6E5-8195A-01	PH375-0048	115	6F5-11610-00	REC6F5-11610-10	263	6G1-24306-55	PAF15-09000000	74
6E5-8195C-01	PH375-0048	115	6F5-11610-10	REC6F5-11610-10	263	6G1-24411-00	REC6G1-24411-00	87
6E5-82570-05	REC704-82570-12	128	6F5-11610-20	REC6F5-11610-20	263	6G1-24431-01	REC6E0-24434-00	87
6E5-85510-10	REC6E5-85510-11	121	6F5-11633-00	REC6F5-11633-00	233-235-260-261-263	6G1-24431-01	REC6G1-24431-01	87
6E5-85510-11	REC6E5-85510-11	121	6F5-11650-11	REC6R5-11650-10	247	6G1-24471-00	REC6G1-24471-00	87
6E5-85540-10	REC6E5-85540-12	119	6F5-11651-00	REC6F5-11651-00	233-235-260-261	6G1-41112-A1	REC6G1-41112-A1	140-223
6E5-85540-11	REC6E5-85540-12	119	6F5-11681-00	REC6F5-11681-00	235-261	6G1-41114-A0	REC6G1-41114-A0	140-223
			6F5-12411-00	REC6F5-12411-03	137	6G1-41133-A0	REC6G1-41133-A0	268
			6F5-12411-01	REC6F5-12411-03	137	6G1-42138-00	PAF4-01090100	131
			6F5-12411-02	REC6F5-12411-03	137-235-239	6G1-42138-01	PAF4-01090100	131
			6F5-12411-03	REC6F5-12411-03	137	6G1-44315-A0	REC6G1-44315-A0	155-346
			6F5-13621-A1	REC6F5-13621-A1	275	6G1-44322-00	REC6G1-44322-00	155-346
			6F5-13645-A1	REC6F5-13645-A0	274	6G1-44323-00	REC6G1-44323-00	155-346
			6F5-13646-A1	REC6F5-13646-A2	274	6G1-44328-00	REC6G1-44328-00	346
			6F5-14198-A1	REC6F5-14198-A1	275	6G1-44352-00	CEF500302	143
			6F5-14323-01	REC6F5-14323-00	98	6G1-44352-00	REC6G1-44352-00	143-155-346
			6F5-14384-00	REC6F5-14384-00	94	6G1-45113-A1	REC6G1-45113-A1	223-252

R.O. / OEM	REF		R.O. / OEM	REF		R.O. / OEM	REF	
6G1-45214-00	PAF15-06000003	289-293-350	6G5-81960-A0	REC6G5-81960-A0	116	6H1-W0093-01-00	REC6H1-W0093-01-00	243
6G1-45215-00	PAF15-06000002	289	6G5-85510-10	REC6G5-85510-11	121	6H1-W0093-10	REC6H1-W0093-10	97
6G1-45251-02	CM6G1-45251-02	159-169	6G5-85540-10	REC6G5-85540-12	119	6H14525102	CM6H1-45251-02	158-169
6G1-45251-02	TEN01108	165-169	6G5-85540-11	REC6G5-85540-12	119		CM6H1-45251-02A	69-70-71-158-169
6G1-45251-03	CM6G1-45251-03	159-169	6G5-85540-12	REC6G5-85540-12	119			
6G1-45251-03	TEN01118	164-169	6G5-W0001-03	REC6G5-W0001-A3	252	6H2-81960-10	REC6H2-81960-10	116
6G1-45315-A0	REC6G1-45315-A0	346	6G5-W0001-03	REC6G5-W0001-A3	254	6H2-85540-10	REC6H2-85540-13	118
6G1-45316-09	REC6G1-45316-09	289	6G5-W0001-A3-00	REC6G5-W0001-A3	247	6H2-85540-11	REC6H2-85540-13	118
6G1-45317-09	REC6G1-45317-09	289	6G5-W0078-00	REC6G5-W0078-A1	152	6H2-85540-12	REC6H2-85540-13	118
6G1-45362-09	REC6G1-45362-09	289	6G5-W0078-01	REC6G5-W0078-A1	152	6H2-85540-13	REC6H2-85540-13	118
6G1-45611-01	REC6G1-45611-01	346-387	6G5-W0078-A1	REC6G5-W0078-A1	152-157-378	6H2-W0001-20	REC6H2-W0001-20	146
6G1-45631-00	REC6G1-45631-00	346-387	6G8-11181-00	REC6G8-11181-A1	181	6H2-W0093-10	REC6H2-W0093-10	96-241
6G1-45941-00-EL	SOL3011-085-09	402	6G8-11181-A1	REC6G8-11181-A1	215-218	6H3-11181-A2	REC6H3-11181-A0	241-248-254
6G1-45943-00-EL	SOL3011-085-08	402	6G8-11197-01	PAF20-05030009	203-205	6H3-11193-A1	REC6H3-11193-A1	241-255
6G1-45947-00-EL	SOL3011-085-07	402	6G8-11197-A0	PAF20-05030009	187	6H3-11325-01	CM6H3-11325-01A	241
6G1-81940-00	REC89-825096T01	114	6G8-11325-00	CM6G8-11325-00	159-169-181	6H3-11631-01-96	REC6H3-11631-01K	241-262-266
6G1-81941-10	PAF15-05170300W	111-114			65-159-180-187-195-201-203-205	6H3-11633-00	REC6H3-11633-00	241-261-262-264
6G1-81941-10	REC89-825096T01	110	6G8-11325-00	CM6G8-11325-00A	163-169	6H3-11635-01	REC6H3-11635-01K	241-262
6G1-81970-00	REC6G1-81970-62	116			181	6H3-11636-01	REC6H3-11636-01K	241-262
6G1-81970-60	REC6G1-81970-62	116	6G8-11325-00	TEN01148	181	6H3-12411-00	REC6H3-12411-10	137
6G1-81970-61	REC6G1-81970-62	116	6G8-11351-00	REC6G8-11351-A0	217	6H3-12411-01	REC6H3-12411-10	137
6G1-81970-62	REC6G1-81970-62	116	6G8-11351-A0	REC6G8-11351-A0	218	6H3-12411-10	REC6H3-12411-10	137-241
6G1-81970-A0	REC6G1-81970-62	116	6G8-12411-00	REC6G8-11351-A0	181	6H3-12411-11	REC6H3-12411-10	137
6G1-W0001-C0	REC6G1-W0001-C1	144	6G8-12411-02	REC6AH-12411-00	191	6H3-12413-00-1S	PAF15-07010021	197-207-241
6G1-W0078-00	REC6G1-W0078-A1	150			195-197-201-203-205-207	6H3-12413-00-9M	PAF15-07010021	191
6G1-W0078-01	REC6G1-W0078-A1	150	6G8-12411-03	PAF15-07000031	66-67-68-69-	6H3-12413-001S	PAF15-07010021	183
6G1-W0078-A1	REC6G1-W0078-A1	150-346			137	6H3-12414-A1	REC6H3-12414-A1	138-241
6G1-W0078-A1	REC6G1-W0078-A1	155	6G8-12414-03	PAF15-07000031	181	6H3-13621-A1	REC6H3-13621-A1	274
6G1-W0093-00	REC6G1-W0093-00	93-95-223	6G8-12414-00	REC6G8-12414-A0	138	6H3-13622-A1	REC6H3-13622-A1	274
6G5-11181-A3	REC6G5-11181-A2	247-249-254	6G8-12414-A0	REC6G8-12414-A0	83	6H3-14198-A1	REC6H3-14198-A1	274
6G5-11193-A1	REC6G5-11193-A0	255	6G8-13440-00	REC6G8-13440-00	273	6H3-14457-01	REC6H3-14457-01	94
6G5-11382-A1	REC6G5-11382-A1	142-245-247	6G8-13645-00	REC6G8-13645-00	273	6H3-14590-01	REC6H3-14590-00	93-98
6G5-11411-02	REC6G5-11411-02	247-256	6G8-13646-00	REC6G8-13646-A0	273	6H3-41112-A0	REC6H3-41112-A0	141-241
6G5-11631-00-93	REC6G5-11631-00K	265-266-267	6G8-14198-00	REC6G8-14198-A0	273	6H3-41114-A0	REC6H3-41114-A0	141-241
6G5-11642-00-93	REC6G5-11642-00K	265-266-267			181-185-187-191-195-197-201-203-205-207-209-211-213-214	6H3-41217-00	REC6H3-41217-00	101
6G5-12416-00	REC6G5-12416-00	209-211	6G8-15363-00	PAF15-07050004	140-181	6H3-44311-00	REC6H3-44311-00	148
6G5-13645-A2	REC6G5-13645-A1	276			171	6H3-44315-00	REC6H3-44315-00	154-156
6G5-14416-A1	REC6G5-14416-A1	275	6G8-15374-00	REC6G8-15374-00	273	6H3-44323-00-00	REC6H3-44323-00	149-154-156
6G5-14483-A1	REC6G5-14483-01	276	6G8-41112-02	REC6G8-41112-02	140-181	6H3-44352-00	CEF500316	143
6G5-41112-A1	REC6G5-41112-A1	142-247	6G8-41114-00	REC6G8-41114-00	140		REC6H3-44352-00	143-154-156-313-317
6G5-41114-A0	REC6G5-41114-A0	142-247	6G8-44532-00	PAF2.6-04000009	171	6H3-44391-00	PAF15-05000009	139
6G5-41134-A1	REC6G5-41134-A1	270	6G8-45113-A1	REC6G8-45113-A1	271	6H3-44391-01	PAF15-05000009	139
6G5-41217-01	REC6G5-41217-00	101	6G8-45251-00	CM6G8-45251-01	159-169	6H3-45113-00	REC6H3-45113-00	241
6G5-43864-00	REC6G5-43864-00	125	6G8-45251-01	TEN01137	164-169	6H3-45113-A1	REC6H3-45113-00	253-254
6G5-43880-00	PH200-T030	123	6G8-46241-00	REC6G8-46241-00	267	6H3-45114-A1	REC6H3-45114-A1	271
6G5-43880-01	PH200-T030	123	6G8-818000-10	PH130-0062	110	6H3-45123-00	REC6H3-45123-00	269
6G5-43880-02	PH200-T030	123	6G8-818000-11	PH130-0062	110	6H3-45127-00	REC6H3-45127-00	269
6G5-44150-02	REC6G5-44150-02	381	6G8-81870-00	REC6G8-81870-00	120		PH130-0050	111
6G5-44323-00	REC6G5-44323-00	329-333-381-385	6G8-81960-A1	REC6G8-81960-A1	117		PH130-0050	111
6G5-44323-00	REC6G5-44323-00	155-157	6G8-W0001-A3	REC6G8-W0001-A3	181-216-218	6H3-81800-11	REC6H3-81800-11	114
6G5-44323-01	REC6G5-44323-00	149	6G9-85540-20	REC6G9-85540-29	117-118	6H3-82510-00	REC6H3-82510-03	114
6G5-45113-A1	REC6G5-45113-A1	245-247	6G9-85540-21	REC6G9-85540-29	117-118	6H3-82510-01	REC6H3-82510-03	114
6G5-45113-A2	REC6G5-45113-A1	253-254	6G9-85540-22	REC6G9-85540-29	117-118	6H3-82510-02	REC6H3-82510-03	114
6G5-45114-A1	REC6G5-45114-A0	272	6G9-85540-29	REC6G9-85540-29	117-118	6H3-85470-10	REC6H3-85570-10	104
6G5-45251-01	CM6G5-45251-01	158-169	6G9-85540-29	REC6G9-85540-29	117-118	6H3-85520-00	REC6H3-85520-00	107
6G5-45251-01	CM6G5-45251-01A	70-158-169	6G9-W0001-C4	REC6G9-W0001-C4	144	6H3-85540-10	REC6H3-85540-10	118
6G5-45251-01	TEN01112	166-169	6G9-W0001-C6	REC6G9-W0001-C6	144	6H3-85540-11	REC6H3-85540-13	118
6G5-45251-01	TEN0112AL	166-169	6GH-45251-00	CM6G1-45251-03	159	6H3-85540-11	REC6H3-85540-13	118
6G5-45251-02	TEN01112	166-169	6H0-81960-00	REC6H0-81960-00	116	6H3-85540-11	REC6H3-85540-13	118
6G5-45251-02	TEN0112AL	166-169	6H0-82105-02	PAT85-05000023	112	6H3-85540-12	REC6H3-85540-11	118
6G5-45383-01	REC6G5-45383-01	327-379	6H0-82105-J2	PAT85-05000023	112	6H3-85540-12	REC6H3-85540-11	118
6G5-45384-00	REC6G5-45384-00	327-379	6H0-W0093-00	REC6H0-W0093-00	97	6H3-85540-13	REC6H3-85540-13	118
6G5-45501-21	REC6G5-45501-21	381-391-392	6H1-11372-00	PAF15-04000005	187	6H3-W0001-02	REC6H3-W0001-02	241-250-254
6G5-45536-01	REC6G5-45536-01	381	6H1-11631-03-95	REC6H1-11631-03K	264-266	6H3-W0001-22	REC6H3-W0001-22	145
6G5-45551-01	REC6G5-45551-00	379-391-392	6H1-14485-00	PAT15-04010202	171		REC6H3-W0078-02	68-69-152-154-156
6G5-45560-01	REC6G5-45560-00	379-391-392	6H1-15359-01-94	REC6H1-15359-01-94	243	6H3-W0078-00	REC6H3-W0078-02	93-97
6G5-45571-02	REC6G5-45571-00	379-391-392	6H1-43800-13-4D	REC6H1-43800-17-8D	124	6H3-W0093-02	REC6H3-W0093-02	248-254
6G5-45576-10	REC6G5-45576-10	327	6H1-43800-14-4D	REC6H1-43800-17-8D	124	6H4-11181-A2	REC6H4-11181-00	255
6G5-45631-00	REC6G5-45631-00	379-391-392	6H1-43800-15-4D	REC6H1-43800-17-8D	124	6H4-11193-00	REC6H4-11193-A1	264-266
6G5-45941-00-98	SOL3511-150-15	403	6H1-43800-16-4D	REC6H1-43800-17-8D	124	6H4-11610-00	REC6H4-11610-00-00	264-266
6G5-45941-00-98	SOL3513-148-15	403	6H1-43800-17-8D	REC6H1-43800-17-8D	122	6H4-11631-00-96	REC6H4-11631-00K	237-263-266
6G5-45941-00-98	SOL3571-158-15	403			122	6H4-11631-01-95	REC6H4-11631-01K	237-263-264
6G5-45945-01-98	SOL3511-145-19	403	6H1-43880-00	PH200-T041	373	6H4-11634-01	REC6H4-11634-01	264
6G5-45945-01-98	SOL3513-143-19	403	6H1-43880-02	PH200-T029	122	6H4-11635-00	REC6H4-11635-00K	237-263
6G5-45945-01-98	SOL3571-153-19	403	6H1-44144-00	REC6H1-44144-00	315-319	6H4-11635-01	REC6H4-11635-01K	264
6G5-45945-01-98	SOL3571-153-17	403	6H1-45214-00	REC6H1-45214-00	315-319	6H4-11636-00	REC6H4-11636-00K	237-263
6G5-45947-01-98	SOL3511-148-17	403	6H1-45215-00	REC6H1-45215-00	158-169	6H4-11636-01	REC6H4-11636-01K	237-261
6G5-45947-01-98	SOL3513-145-17	403	6H1-45251-01	CM6H1-45251-01	158	6H4-11641-00	REC6H4-11641-00	274
6G5-45947-01-98	SOL3571-155-17	403	6H1-45251-01	CM6H1-45251-01A	167	6H4-14198-00	REC6H4-14198-09	274
6G5-45949-00-98	SOL3511-142-23	403	6H1-45251-02	TEN01125	166-169	6H4-14198-01	REC6H4-14198-01	274
6G5-45949-00-98	SOL3511-143-21	403	6H1-45251-02	TEN01115AL	166-169	6H4-14548-00	PAF25-05070019	99
6G5-45949-00-98	SOL3512-142-23	403	6H1-45251-03	TEN01113	166-169	6H4-14984-00	REC6H4-14984-00	100
6G5-45949-00-98	SOL3513-140-21	403	6H1-45611-01-00	REC6H1-45611-00	373-390-391	6H4-14985-01	REC6H4-14985-01	100
6G5-45949-00-98	SOL3571-148-23	403	6H1-45631-01-0					



R.O. / OEM	REF		R.O. / OEM	REF		R.O. / OEM	REF	
6H4-44352-02	REC6H4-44352-02	154-155-156	6K7-W0093-09	REC6K7-W0093-09	97	6P2-24563-00	REC6P2-WS245-00	81
6H4-45113-00	REC6H4-45113-00	237	6K8-41122-A1	REC6K8-41122-A1	141-229	6P2-41112-00	REC6P2-41112-00	213
6H4-45113-A0	REC6H4-45113-00	253-254	6K8-41124-A1	REC6K8-41124-A1	141-229	6P2-41114-00	REC6P2-41114-00	213
6H4-45536-00	PAT40-04000002	301-305-309-313	6L2-11181-A3	REC6L2-11181-A1	248-254	6P2-41122-00	REC6P2-41122-00	213
6H4-45551-00	REC6H4-45551-00	359-389-390	6L2-11193-A1	REC6L2-11193-A1	255	6P2-44150-00	REC6P2-44150-00	339
6H4-45560-00	REC6H4-45560-00	359-389-390	6L2-13621-00	REC6L2-13621-00	274	6P2-44323-0	REC6P2-44323-00	149
6H4-45571-00	REC6H4-45570-00	359-389-390	6L2-14384-00	REC6L2-14384-00-00	94	6P2-44323-00	REC6P2-44323-00	155-157-339
6H4-45631-00	REC6H4-45631-00	389-390	6L2-14385-00	REC6L2-14385-00	93-100	6P2-45300-20-8D	REC422-B25F	278-339
6H4-81800-10	PH130-0063	110	6L2-14399-00	REC6L2-14399-00	94	6P2-45300-21-8D	REC422-B25F	278-339
6H4-81800-11	PH130-0063	110	6L2-26301-00	REC6L2-26301-00	129	6P2-45300-40-8D	REC422-B25F	278
6H4-81800-12	PH130-0063	110	6L2-41112-A2	REC6L2-41112-A3	141	6P2-45300-41-8D	REC422-B25F	278
6H4-W0001-01	REC6H4-W0001-A1	250-254	6L2-41114-A1	REC6L2-41114-A1	141	6P2-45331-00-9S	REC6P2-45331-00-9S	339
6H4-W0001-04	REC6H4-W0001-04	237-250	6L2-41133-A3	REC6L2-41133-A3	268	6P2-45501-00	REC6P2-45501-01	339
6H4-W0001-21	REC6H4-W0001-21	359	6L2-41134-00	REC6L2-41134-00	268	6P2-45501-10	REC6P2-45501-11	339
6H4-W0078-00	REC6H4-W0078-00	151	6L2-44322-00	REC6L2-44322-00	155	6P2-46241-01	REC6P2-46241-02	213
6H4-W0078-A0	REC6H4-W0078-00	155-156-359	6L2-44352-00	CEF500384	143	6P2-46241-02	REC6P2-46241-02	267
6H4-W0093-01	REC6H4-W0093-01-00	96	6L2-44352-00	REC6L2-44352-00	66-143-155	6P2-81960-02	REC6P2-81960-03	116
6H4-W0093-03	REC6H4-W0093-03	96-237	6L2-44367-00	PAF25-04050004	293-297-355	6P2-81960-03	REC6P2-81960-03	116
6H5-43880-00	PH200-T048	122	6L2-45113-A1	REC6L2-45113-A2	253-254	6P2-W0001-00	REC6P2-W0001-01	217
6H5-43880-01	PH200-T048	122	6L2-45214-00	PAF25-04000022	295	6P2-W0001-01	REC6P2-W0001-01	213-217-218
6H5-43880-02	PH200-T048	122	6L2-45215-00	PAF25-04000023	295	6P2-W0078-00	REC6P2-W0078-00	73-153-155-157
6H5-43880-09	PH200-T048	122	6L2-45567-12	PAF25-04000004-3	295	6P2-WS245-00	REC6P2-WS245-00	81
6H9-45551-00	REC6H9-45551-00	365-389	6L2-45567-14	PAF25-04000004-5	295	6P245300208D	REC422-B25F	278
6J1-11610-00	REC6J1-11610-00	221	6L2-45577-00-10	PAF25-04070005-1	295-355	6P245300218D	REC422-B25F	278
6J4-81800-00	PH130-0062	110	6L2-45577-00-12	PAF25-04070005-3	295	6P245300408D	REC422-B25F	278
6J4-81800-01	PH130-0062	110	6L2-45611-00	REC6L2-45611-00	355-388-389	6P245300418D	REC422-B25F	278
6J8-11181-A1	REC6J8-11181-A2	231	6L2-45987-01	REC6L2-45987-00	295-355-357-405	6P3-24563-00	REC6P3-WS24A-00	81
6J8-11181-A2	REC6J8-11181-A2	248-254	6L2-81800-10	PH130-0061	110	6P3-24564-00	REC6P3-24564-00	71-72-73-81
6J8-11325-00	TEN01150	163-229-231	6L2-81800-11	PH130-0061	110	6P3-45300-40-8D	REC422-B25F	278-339
6J8-11631-02-97	REC6J8-11631-02	231-263-266	6L2-81800-12	PH130-0061	110	6P3-45300-41-8D	REC429-B25F	278-339
6J8-12414-A0	REC61A-12414-A0	237	6L2-W0001-A2	REC6L2-W0001-03	250-254	6P3-45300-42-8D	REC429-B25F	278
6J8-13411-00	REC6J8-13411-00	83	6L2-W0001-C3	REC6L2-W0001-C3	145	6P3-WS24A-00	REC6P3-WS24A-00	81
6J8-24471-00	REC6J8-24471-00	87	6L2-W0078-00	REC6L2-W0078-00	151-155	6P3-WS24A-01	REC6P3-WS24A-00	71-72-73-81
6J8-44311-00	REC663-44311-02	357	6L2-W0093-00	REC6L2-W0093-00	95	6P345300408D	REC429-B25F	278
6J8-45113-A0	REC6J8-45113-00	231-253-254	6L5-14301-03	REC6L5-14301-03	91-93	6P345300418D	REC429-B25F	278
6J8-81960-00	PAF15-07060001	117	6L5-24251-00	PAF4-04120005	64-80-81-82	6P345300428D	REC429-B25F	278
6J8-85540-H2	REC6J8-85540-H2	120	6L5-44322-00	PAF2.6-03000015	154-283	6R0-44366-00	PAF4-03000021	283
6J8-W0001-21	REC6J8-W0001-21	145-357	6L5-44323-00	REC6L5-44323-00	149	6R3-11411-00	REC6R3-11411-00	256
6J8-W0078-A1	REC6J8-W0078-A2	150-151	6L5-44352-00	CEF500322	143	6R3-81960-10	REC6R3-81960-10	116
6J8-W0078-A2	REC6J8-W0078-A2	155-357	6L5-44352-00	PAF2.6-03000100	64-283	6R3-82563-01	REC6R3-82563-01	122
6J9-45332-00-CA	REC6J9-45332-00-CA	327-379-391-392	6L5-44352-00	REC6L5-44352-00	143-154	6R3-82563-01	REC6R3-82563-01	122
6J9-45371-00	TEN01143	165	6L5-45251-02	CM6L5-45251-02	159-343	6R3-85570-01104	REC6R3-85570-01	104
6J9-45371-01	CM6J9-45371-01	160-169	6L5-45251-02	CM6L5-45251-02	169	6R3-W0001-A3	REC6R3-W0001-03	252
6J9-45371-01	CM6J9-45371-01A	72-160-169-327	6L5-45251-02	CM6L5-45251-02A	159	6R4-13200-00	REC6R4-13200-02	84
6J9-45371-01	TEN01133	165-169	6L5-45251-02	TEN01117	166-169	6R4-13200-01	REC6R4-13200-02	84
6J9-45371-01	TEN01133AL	165-169	6L5-45251-03	CM6L5-45251-02	345	6R4-13200-02	REC6R4-13200-02	84
6J9-45371-02	CM6K1-45371-02	160-169	6L5-45316-09	PAF2.6-03000003	283	6R5-11361-11-93	REC6R5-11361-11K	245
6J9-45371-02	CM6K1-45371-02A	72-160-169	6L5-45317-09	PAF2.6-03000002	283	6R5-11603-00	REC6R5-11603-00	265-266-267
6J9-45611-01	REC6J9-45611-00	327-379-391-392	6L5-45333-00-20	PAF2.6-03000017	283	6R5-11631-11-93	REC6R5-11631-01K	265-266-267
6K1-45371-00	CM6K1-45371-00	161-169	6L5-45551-00	PAF2.6-03000018	283	6R5-11633-10	REC6R5-11633-00	245-247-261-265
6K1-45371-00	CM6K1-45371-00A	161-169	6L5-45560-00	PAF2.6-03000019	283	6R5-11634-00	REC6R5-11634-00	265
6K1-45371-00	TEN01144	168-169	6L5-45616-00	PAF4-03080000	283-285-287-405	6R5-11634-10	REC6R5-11634-00	245-247-265
6K1-45371-00	TEN01144AL	168-169	6L5-45616-02	REC647-45616-02	345	6R5-11642-11-93	REC6R5-11642-01K	245-265-266-267
6K1-45371-02	TEN01134	165-169	6L5-45631-00	PAF2.6-03000201	283	6R5-11642-11-93	REC6R5-11642-11K	265-266-267
6K1-45945-01-98	SOL3512-145-19	403	6L5-45631-00	PAF2.6-03000202	283	6R5-116950-00	REC6R5-11650-10	245
6K1-45945-01-98	SOL3514-143-19	403	6L5-45943-00-EL	PAF2.6-03010000	283	6R6-W0001-02	REC6R6-W0001-02-00	250-254
6K1-45945-01-98	SOL3572-153-19	403	6L5-45949-00-EL	PAF2.6-03010000	402	6R7-11181-A1	REC6R7-11181-A0	248-254
6K1-45947-00-98	SOL3512-148-17	403	6L5-45949-00-EL	SOL30111-073-05S	402	6S1-41136-00	REC6S1-41136-00	270
6K1-45947-00-98	SOL3514-145-17	403	6L5-45987-01	PAF4-03000025	345	6S1-85885-00	REC6S1-85885-00	90-102
6K1-45947-00-98	SOL3572-155-17	403	6L6-45371-00	TEN01103	164-169	6T4-45836-00	CM6T4-45836-00	159
6K1-45970-01-98	SOL3532-145-15	403	6L6-45371-00	TEN01103AL	164-169	6T4-45836-00	TEN01122	164
6K1-45972-01-98	SOL3532-140-21	403	6L8-G3118-01	REC6L8-G3118-01	134	6T5-45251-00	TEN01139	167
6K1-45974-02-98	SOL3532-140-19	403	6M6-14385-00	REC6H4-14985-01	100	6T5-45371-00	CM6T5-45371-00	161
6K1-45976-00-98	SOL3532-140-23	403	6N0-E1603-00	REC6G1-11610-00	223	6T5-45371-00	TEN01119	165
6K1-45978-02-98	SOL3532-143-17	403	6N0-G2177-00	REC6N0-G2177-00	134	6T5-45373-00	TEN01120	166
6K1-82510-06	REC6K1-82510-07	113	6N0-G5251-00	TEN01118	346	6T5-45373-00	CM6T5-45373-00	159
6K1-82570-13	REC6K1-82570-13	128	6N0-G5551-00	REC6N0-G5551-00	346-387	6U0-45251-00	TEN01157	165-169
6K4-11422-00	REC6K4-11422-00	256	6N0-G5551-A0	REC68T-45551-00	289	6U4-45251-00	CM6U4-45251-00	158-169
6K4-11432-00	REC6K4-11432-00	256	6N0-G5560-00	REC6N0-G5560-00	346-387	6U4-45251-00	TEN01159	167-169
6K4-11651-00	REC6K4-11651-00	260	6N0-G5571-00	REC6N0-G5571-00	346-387	6U4-45373-00	TEN01158	166-169
6K5-11601-02	REC6K5-11601-02	241-262-264-266	6N0-W0001-20	REC6G1-W0001-C1	346	6U0-45251-00	CM6U0-45251-00	159-169
6K5-11601-12	REC6K5-11601-12	241-262-264	6N0-W0078-A0	REC6G1-W0078-A1	150	6V3-45251-01	TEN01138	164
6K5-11601-22	REC6K5-11601-22	241-262-264	6N0-WG525-00	CM6G1-45251-03	159	6X2-85885-10	REC6X2-85885-10	103
6K5-11631-03-95	REC6K5-11631-03K	264-266	6N6-W0001-A3	REC6E5-W0001-A2	245	PAF15-10000003	PAF15-10000003	76
6K5-11635-03	REC6K5-11635-03K	264	6N6-W0078-02	REC6N6-W0078-02	152	6Y1-24305-00	GS31075	76
6K5-11636-03	REC6K5-11636-03K	264	6N6-W0093-02	REC6N6-W0093-02	152-155-156-157	6Y1-24305-01	GS31075	76
6K5-11681-00	REC6K5-11681-00	261	6N7-11411-00	REC6N7-11411-00	97-245	6Y1-24305-02	GS31075	76
6K5-14301-03 +			6N7-81800-00	PH130-0051	245-256	6Y1-24305-05-00	GS31074	76
6K5-14302-03 +	REC6K5-14301-03	92-93	6N7-81800-01	PH130-0051	110	6Y1-24305-05-00	GS31075	76
6K5-14303-03			6N7-81800-10	PH130-0051	110	6Y1-24305-06-00	GS31074	76
6K5-45551-00	REC6K5-45551-00	388-390	6P2-11181-00	REC6P2-11181-00	213-216-218	6Y1-24305-06-00	GS31075	76
6K5-45560-00	REC6K5-45560-00	388-390	6P2-11182-00	REC6P2-11182-00	213-216-218	6Y1-24360-55-00	PAF15-09000000	74
6K5-45570-00	REC6K5-45570-00	390	6P2-11193-00	REC6P2-11193-00	213	6Y1-24360-52	GS31187	74
6K5-W0001-								

R.O. / OEM	REF		R.O. / OEM	REF		R.O. / OEM	REF	
6Y2-24305-06-00	GS31076	76	90105-16M67	PAT85-0000012	315-319	90201-10144	PAF25-05050018	201
6Y2-24360-52	GS31090	74	90109-06M65	PAF25-05050006	191-195-197-201-203-205-207	90201-10M01	PAGB/T96-10	293-349
6YJ-24167-00	PAF15-10000002	76	90109-08022	REC90109-08022	239-243-247	90201-10M01	REC90201-10M01	289-405
6YJ-24260-00	PAF15-10020000	76	90109-08M63	PAF25-05050019	193-199-207	90201-10M06	PAF25-05050018	193-199-207
6YJ-24260-10	PAF15-10020000	76	90109-08M71	REC90109-08M71	245	90201-11M49	PAF4-03000006	287-343
6YJ-24610-00	PAF15-10010000	75	90119-06M04	PAGB/T5783-M6X30	227	90201-12565	REC90201-12565	225-260
6YJ-24610-01	PAF15-10010000	75	90119-06M10	REC90119-06M10	325-329-333-377-385	90201-13198	PAF2.6-03000021	283
6YK-24305-01-00	GS31076	76	90119-06M40	PAGB/T5782-2000S	285	90201-13201	PAF15-07040017	180-185
6YL-24305-01-00	GS31074	76	90119-06M48	PAGB/T5783-M5X12	295	90201-15017	PAF15-06000020-1	293
6YL-24305-01-00	GS31075	76	90119-06M80-00	PAGB/T5783-M6X14	177	90201-15423	PAF20-05030011	189
703-48152-00	PAF15-13020007W	129	90119-06MA2	PAGB/T5783-M6X20	179-227	90201-16M00	REC90201-16M00	331-335-337-383
703-48205-10	PAT85-08010000W	126	90119-06MA3	PAF8-05000022	187	90201-17682	REC90201-17682	291-293-349-351
703-48205-10	REC703-48205-16	126	90119-06MA3	PAGB/T5783-M6X20	191	90201-17M00-00	REC90201-17M00	373
703-48205-12	REC703-48205-16	126	90119-06MA3	PAGB/T5783-M6X25	187-191-235	90201-20417	PAF25-04060007	295
703-48205-13	REC703-48205-16	126	90119-06MA4	PAGB/T5783-M6X30	235	90201-20417	REC90201-20417	233-235-239-241-243-260-261-353-355-357
703-48205-14	REC703-48205-16	126	90119-06MA5	PAGB/T5782-M6X35	191-203-205-233-241	90201-20M27	REC90201-20M27	229-260
703-48205-15	REC703-48205-16	126	90119-06MA5	PAGB/T5783-M6X25	191	90201-21M75	REC90201-21M75	245-247-261
703-48205-16	REC703-48205-16	126	90119-06MA5	PAGB/T5783-M6X35	243	90201-22008	PAT40-04050007	311
703-48205-17	REC703-48205-16	126	90119-06MAS	PAGB/T5783-M6X35	191	90201-22429	REC90201-22429	299-303-307-359-361-365-369
703-48205-18	REC703-48205-16	126	90119-08M01	PAGB/T5782-M8X80	191	90201-22M01	REC90201-22M01	325-329-333-377-381-385
703-48205-1A	REC703-48205-16	126	90119-08M13	REC90119-08M13	321-357-371	90201-23008	PAF2.6-04000003	173
703-48205-1B	REC703-48205-16	126	90119-08M14	REC90119-08M14	317-325-329-333-335-339-341-377-381-385-386	90201-23M01	REC90201-23M01	245-247-261
703-48205-21	REC703-48205-16	126	90119-08M15	REC90119-08M15	301-305-309-13-361	90201-266P2	PAF4-04000004	175
703-48230-10	PAF15-13000000W	126	90119-08M21	REC90119-08M21	231	90201-27M00	PAT40-04000008	301-305-309-313
703-48230-10	REC703-48230-14	126	90119-08M33	REC90119-08M33	317	90201-30M92	REC90201-30M92	323-327-375-379
703-48230-11	REC703-48230-14	126	90119-08M87	REC90119-08M87	321	90201-31M00	REC90201-31M00	331-383
703-48230-12	REC703-48230-14	126	90119-08MA5	PAGB/T5783-M6X25	235	90201-42014	REC90201-42014	339
703-48230-13	REC703-48230-14	126	90119-09M00	PAF25-05000002	191-197-207	90201-46M29	REC90201-46M29	227
703-48230-14	REC703-48230-14	126	90142-05M06	PAGB/T820-M5X30	299	90202-12060	PAF25-02000019	297-301-305-309-367-371
703-48230-15	REC703-48230-14	126	90149-06M00	REC90149-06M00	365	90204-11M49	PAF4-03000006	285-345
703-48230-16	REC703-48230-14	126	90151-05M05	PAGB/T820-M5X30	295	90206-22M19	REC90206-22M19	377-381-385
703-48230-17	REC703-48230-14	126	90152-05M00	REC90151-05M00	315-319	90208-04010	REC90282-04010	365
703-48230-18	REC703-48230-14	126	90152-05M03	PAGB/T820-M5X25	289	90209-18112	REC90209-18112	221-223-225-260
703-48230-1A	REC703-48230-14	126	90152-05M04	PAGB/T820-M5X25	350	90209-20M23	REC90209-20159	227-260
703-48230-20	REC703-48230-14	126	90152-05M06	PAGB/T820-M5X30	307-365	90209-24M03	REC90209-24M03	229-260-261
703-48230-21	REC703-48230-14	126	90170-012138	REC90170-12138	365	90209-27M07	REC90209-27M07	233-235-260-261
703-48245-00	PAF15-13010010W	130	90170-12138	REC90170-12138	299-303-307-311-359-361-369	90209-27M11	REC90209-27M11	261
703-48261-01	PAF15-13000500W	127	90170-16M01	REC90170-16M01	315-319-323-327-371-375-379	90214-48M03	REC90214-48M03	365-369
703-48272-12	PAF40-13000000E1	126	90170-16M01-00	REC90170-16M01-00	373	90250-03M10	REC90250-03M10	343
703-48293-10	PAF15-11000002W	129	90170-16M19	REC90170-16M19	331-335-337-383	90250-05010	REC90250-05010	291-293-295-349-351-353-355-357
703-48345-01	PAF25-07000007W	127	90170-16M19	REC90170-16M19	195	90250-05036	REC90250-05036	347
703-48861-11	PAT20-13000500W	1276	90170-20137	PAF25-05000026	185	90250-05046	REC90250-05046	345
703-82510-12	PAF15-13000200W	113	90170-28M37	PAF15-07030005	185	90250-06023	REC90250-06023	299-303-307-311-359-361-363-365-369
703-82510-43	REC703-82510-44	114	90170-30M03	PAF20-05000029	189	90250-07M02	REC90250-07M02	315-319-371
703-82563-00	PAE4-10040100W	122-128	90170-35M47	PAF25-05000026	193	90250-07M02-00	REC90250-07M02	373
703-82563-01	PAE4-10040100W	122-128	90171-10M01	PAF15-06000016	349	90250-08M07	REC90250-08M07	323-327-335-375-379
703-82563-02	PAE4-10040100W	128	90171-10M01	REC90171-10M01	289-291-293-405-351	90280-03017	PAGB/T1099-3X5X13	201
704-48205-11	REC704-48205-R0	127	90171-10M01	REC90171-10M01	295-353-355-357-405	90280-03024	PAF25-04000015	155-297
704-48205-12	REC704-48205-R0	127	90171-14013	REC90171-14013-00	299-303-307-311-315-319-359-361-365-369-371	90280-03024	REC90280-03024	154-155-156-309-313-346-347-349-357-359
704-48205-13	REC704-48205-R0	127	90171-16011	REC90171-16011	373	90280-03M01	PAGB/T1099-3X5X13	180-185-189-195-203-205
704-48205-14	REC704-48205-R0	127	90171-16011-00	REC90171-16011-00	323-327-331-335-337-341-375-379-383-405	90280-03M03	REC90280-03M03	154-156-301-305-317-355-361-369
704-48205-15	REC704-48205-R0	127	90171-18M04	REC90171-18M04	291-293-348-351	90280-04002	REC90280-04002	335
704-48205-B0	REC704-48205-R0	127	90179-08M06	REC90179-08M06	353	90280-04M00	REC90280-04M00	156-363-367
704-48205-B1	REC704-48205-R0	127	90179-09M02	REC90179-09M02	295-355-357	90280-04M04	REC90280-04M04	154-155-156-321-371
704-48205-P0	REC704-48205-R0	127	90179-10M14	REC90179-10M14	315-319-331-335-337-341-375-379-383-405	90280-04M04-00	REC90280-04M04	373
704-48205-P1	REC704-48205-R0	127	90183-02M03	REC90183-02M03	373-383	90280-04M05	REC90280-04M05	155-156-157-325-329-333-339-377-381-385-386
704-48205-R0	REC704-48205-R0	127	90185-05002	PAGB/T6182-M5	289-293-315-319-323-327-331-335-337-341-350	90280-04M06	PAF25-05000024	199
704-48207-20	REC704-48207-R0	127	90185-22043	PAGB/T889.1-2000	295	90280-04M06	PAF4-04000019	193-207
704-48207-21	REC704-48207-R0	127	90185-22M11	PAF15-01010007	131	90280-05049	REC90280-05049	229
704-48207-22	REC704-48207-R0	127	9020-14377	REC90201-14377	131	90282-04010	REC90282-04010	315-319-323-353-357-359-369-371-373-375
704-48207-30	REC704-48207-R0	127	90201-02M00	REC90201-02M00	227-260	90282-04M00	REC90282-04M00	327
704-48207-31	REC704-48207-R0	127	90201-06M94	PAGB/T5287-6	331-335-337-341-383	90304-08002	REC90340-08002	327-331-335-337-341
704-48207-P1	REC704-48207-R0	127	90201-08784	PAF20-05030013	180-185			283-285-287-289-291-282-299-303-307-311-315-319-323-345-350-353-357-361-363-369-370-373-379-383
704-48207-R0	REC704-48207-R0	127	90201-08818	PAF4-04000006	177			
704-82570-08	REC704-82570-12	128	90201-08818	PAF4-04000006	64-66			
704-82570-10	REC704-82570-12	128	90201-08818	PAGB/T5783-M5X12	183			
704-82570-11	REC704-82570-12	128	90201-08818-00	PAF4-04000006	171			
704-82570-12	REC704-82570-12	128	90201-08M54	PAF4-03000026	283-285-287-345-405			
7FK-12158-00	PA166F-010011	173-175-179						
7FK-12165-00	PA166F-010010	173-175-179						
7NJ-12117-00	PAF8-05030006	173-175						
7NJ-12118-00	PAF8-05030007	173-175-179						
90101-06M56	REC90101-06M56	353						
90101-08001	PAGB/T5783-M8X35	235						
90105-06035	PAGB/T5783-M6X35	189						
90105-06039	PAGB/T5783-M6X16	173						
90105-06M01	REC90105-06M01	363						
90105-06M14	PAGB/T5783-M6X16	175						
90105-06M25	PAGB/T5782-M6X45	175						
90105-08046-00	PAF4-04000033	175						
90105-081A7	PAGB/T5783-M8X25	189						
90105-08M36	PAF4-04000034	173-179-180						
90105-08M36-00	PAF4-04000034	175						
90105-08M76	PAF4-04000001	171						
90105-08M78	PAF15-07000028	180-185						
90105-090006	PAF20-05000002	187						
90105-10M00	PAT85-0000012	323-327-331-335-337-375-379						
90105-10M12	PAF25-0000011	295						



R.O. / OEM	REF		R.O. / OEM	REF		R.O. / OEM	REF	
90340-08014	REC90340-08002	348-359			180-191-197-207-209-213-301-305-309-313-317-321-325	92995-06600	PAGB/T97.1-6	171-173-175-179-180-195-197-201-203-205-209-211-213-221-223-225-235-239-257-289-291-317-321-339-351-355
90340-08M04	REC90340-08002	295-343-347-365-375	90465-11M10	PAHT-2.5X60		92995-06600	PAGB/T97.1-8	185-227-229-233-241
90340-14M00	PAF15-04000002	237-241				92995-08600	PAGB/T97.1-8	179-209-214-325-329-333-335-337-341-343-363-369-377
		191-195-197-201-203-205-207-209-211-213	90465-11M10	PAHT2.5X50		92995-10100	PAGB/T97.1-10	299
90340-14M06	PAF15-04000002	203-205	90465-11M59	REC09401-11425		92995-10600	PAGB/T97.1-8	295-299-303-307-311-315-319-331
90344-51003	PAF15-07010004	351	90467-06016	PAHT-2.5X60		9306-306V5	REC93306-306V5	233-258
90381-14020	REC626-45316-09	133	90467-08004	PAF4-04000030		93101-10M14	PAF4-03000027	285-287
90381-20001	REC90381-20001	133	90467-08M01	PAF4-03000005		93101-10M14	REC93101-10M14	345
90386-10M16	PAT85-01010203	133	90467-09M09	PAF4-04000030		93101-10M25	REC93101-10M25	221
90386-18M35	PAT85-00000017	133	90467-13M13	PAF4-05000010		93101-11M23	REC93101-11M23	289-346
90386-18M63	REC90386-18M63	133	90472-00247	NGKB8HS-10		93101-12M70	REC93101-12M70	341
90386-22M13	REC90386-22M13	133	90480-06M19	PAF20-05000036		93101-13018	REC93101-13018	227
90386-22M15	PAF15-01010302	133	90480-10627	PAF20-05000034		93101-13M12	PAF4-03050002	283-285
90386-22M15	PAF25-01010002	133	90480-10M16	PAF15-07050003		93101-13M12	REC93101-13M12	287-345
90386-22M98	REC90386-22M98	133	90480-12072	PAF15-07010027		93101-13M27	REC93101-13M27	270
90386-25M31	REC90386-25M31	133	90480-18065	REC90480-18065		93101-14M01	REC93101-14M01	225
90386-30048	PAF15-01000004	133				93101-15074	REC93101-15074	289-346-347
90386-30M60	PAF15-01000006	133	90480-20M05	REC90480-20M05		93101-16001	REC93101-16001	229-233
90386-30M77	PAT85-01020005	133	90501-10064	PAF4-03030003		93101-17054	REC93101-17054	291-293-349-351
90386-30M77	REC90386-30M77	133	90501-10065	PAF25-04060002		93101-18050	REC93101-18050	347
90386-30M78	PAT85-01020003	133	90501-10M77	REC90501-10M77		93101-20001	REC93101-20048	292
90386-38M89	REC90386-38M89	133				93101-20048	REC93101-20048	291-349-351-363
90386-44M03	PAF25-01000004	133	90501-11M10	REC90501-11M10-00		93101-20M07	REC93101-20M07	295-353-355-357
90386-52M02	PAF25-01000001	133	90501-120A5	PAF20-05030007		93101-20M29	REC93101-20M29	221-225
90387-06119	REC624-42542-00	98	90501-12M40	PAF15-07040014		93101-20M34	REC93101-20M34	223
90387-06806	PAF4-00000001	285-287	90501-12M41	PAF15-07040013		93101-22067	REC93101-22067	353-355-359-365-367-369
90387-06M14	PAF4-00000001	345	90501-12M48	REC90501-12M48		93101-22067	REC93101-22M00	297
90387-06M69	PAF25-03000007	133	90501-14M02	REC90501-14M02		93101-22M00	REC93101-22M00	299-303-307-311-361-363
90387-13001	PAF15-07040009	185	90501-14M06	PAF15-06070002		93101-22M15	REC93101-22M15	245-247
90387-13002	PAF15-07040011	185	90501-150A0	PAF15-06070002		93101-22M60	REC93101-22M60	301-305-361
90387-13006	PAF20-05030006	189	90501-15M01	PAT40-04050002		93101-23070	REC93101-23070	317-357-359-369
90387-13M56	PAF15-07040012	180-185	90501-16233	REC90501-16233		93101-250-18	REC93101-25018	227
90387-32002	REC90387-32002	229	90501-16M01	REC90501-16M01		93101-25M03	REC93101-25M03	315-319-321-371
		299-303-307-311-361-365-405	90501-16M11	REC90501-16M11		93101-25M03-00	REC93101-25M03	373
90389-22M01	REC90389-22M01	315-319-371-405	90501-16M37	REC90501-16M37		93101-25M28	REC93101-25M35	231
		183-191-197	90501-16M37	REC90501-16M37		93101-25M57	REC93101-25M57	309-313
90401-20M00	PAF15-07010003	191-195-197-201-203-205-207	90501-18001	PAF60-04020002		93101-28M16	REC93101-28M16	325-329-333-335-339-377-381-385-386
90430-06014	PAF25-05050007	209-211-213-214-347-363-365	90501-450A2	REC90501-450A2		93101-300002	REC93101-30002	335-337
		214-347-363-365	90606-12019	REC93606-12019		93101-30M17	REC93101-30M17	323-327-331-375-379-383
90430-06M03	REC90430-06M03	292-303-307-311-315-323-283-285-287-289-291-299-327-331-335-337-341-343-345-346-347-348-350-353-355-357-359-361-363-365-369-370-375-379-383-386-64-65-66-67-68-69-70-71-72-73	907-94469-05	PAF40-0701000E		93101-30M33	REC93101-30M33	235
		292-303-307-311-315-323-283-285-287-289-291-299-327-331-335-337-341-343-345-346-347-348-350-353-355-357-359-361-363-365-369-370-375-379-383-386-64-65-66-67-68-69-70-71-72-73	907-94469-05	REC90794-46866		93102-10004	PAF4-04060004	177-179
90430-08003	REC90430-08020	292-303-307-311-315-323-283-285-287-289-291-299-327-331-335-337-341-343-345-346-347-348-350-353-355-357-359-361-363-365-369-370-375-379-383-386-64-65-66-67-68-69-70-71-72-73	907-94469-13	REC90794-46868		93102-15M32	REC93102-15M32	220
		292-303-307-311-315-323-283-285-287-289-291-299-327-331-335-337-341-343-345-346-347-348-350-353-355-357-359-361-363-365-369-370-375-379-383-386-64-65-66-67-68-69-70-71-72-73	90790-77001	GS35032		93102-18M21	PAF15-07040008	180-185
		292-303-307-311-315-323-283-285-287-289-291-299-327-331-335-337-341-343-345-346-347-348-350-353-355-357-359-361-363-365-369-370-375-379-383-386-64-65-66-67-68-69-70-71-72-73	90890-56878	GS35031		93102-20070	PAF2.6-04010001	171-177-179
90430-08020	REC90430-08020	315-319-371-405	91490-25030	PAGB/T91-1.6X12		93102-20108	PAGB/T97.1-8	183
		183-191-197	91490-30020	PAGB/T91-2.5X20		93102-20108	REC93102-20M25	223-225
		191-195-197-201-203-205-207	91490-30020	REC91490-30025		93102-22010	PAF20-05030005	189
		209-211-213-214-347-363-365	91490-30020	PAGB/T91-1.6X12		93102-23096	REC93102-23096	237
		214-347-363-365	91490-30025	REC91490-30025		93102-25008	REC93102-25008	229
		292-303-307-311-315-323-283-285-287-289-291-299-327-331-335-337-341-343-345-346-347-348-350-353-355-357-359-361-363-365-369-370-375-379-383-386-64-65-66-67-68-69-70-71-72-73	91490-30025	REC91490-30025		93102-25014	PAF15-07030006	189
		292-303-307-311-315-323-283-285-287-289-291-299-327-331-335-337-341-343-345-346-347-348-350-353-355-357-359-361-363-365-369-370-375-379-383-386-64-65-66-67-68-69-70-71-72-73	91490-30025	REC91490-30025		93102-25090	PAF4-04010004	177
		292-303-307-311-315-323-283-285-287-289-291-299-327-331-335-337-341-343-345-346-347-348-350-353-355-357-359-361-363-365-369-370-375-379-383-386-64-65-66-67-68-69-70-71-72-73	91490-30025	REC91490-30025		93102-25090	PAGB/T5783-M5X12	183
		292-303-307-311-315-323-283-285-287-289-291-299-327-331-335-337-341-343-345-346-347-348-350-353-355-357-359-361-363-365-369-370-375-379-383-386-64-65-66-67-68-69-70-71-72-73	91490-30025	REC91490-30025		93102-25M28	REC93102-25M28	237
		292-303-307-311-315-323-283-285-287-289-291-299-327-331-335-337-341-343-345-346-347-348-350-353-355-357-359-361-363-365-369-370-375-379-383-386-64-65-66-67-68-69-70-71-72-73	91490-30030	REC91490-30030		93102-25M48	REC93102-25M48	227
		292-303-307-311-315-323-283-285-287-289-291-299-327-331-335-337-341-343-345-346-347-348-350-353-355-357-359-361-363-365-369-370-375-379-383-386-64-65-66-67-68-69-70-71-72-73	91490-30040	REC91490-30040		93102-25M52	PAF15-07030007	183
		292-303-307-311-315-323-283-285-287-289-291-299-327-331-335-337-341-343-345-346-347-348-350-353-355-357-359-361-363-365-369-370-375-379-383-386-64-65-66-67-68-69-70-71-72-73	91490-40025	REC91490-40030		93102-26M27	REC93102-26M27	231
		292-303-307-311-315-323-283-285-287-289-291-299-327-331-335-337-341-343-345-346-347-348-350-353-355-357-359-361-363-365-369-370-375-379-383-386-64-65-66-67-68-69-70-71-72-73	91490-40025	REC91490-40030		93102-28135	REC93102-28135	239
		292-303-307-311-315-323-283-285-287-289-291-299-327-331-335-337-341-343-345-346-347-348-350-353-355-357-359-361-363-365-369-370-375-379-383-386-64-65-66-67-68-69-70-71-72-73	91490-40030	REC91490-40030		93102-30M05	REC93102-30M05	243
		292-303-307-311-315-323-283-285-287-289-291-299-327-331-335-337-341-343-345-346-347-348-350-353-355-357-359-361-363-365-369-370-375-379-383-386-64-65-66-67-68-69-70-71-72-73	91490-40030	REC91490-40030		93102-30M23	REC93102-30M23	241
		292-303-307-311-315-323-283-285-287-289-291-299-327-331-335-337-341-343-345-346-347-348-350-353-355-357-359-361-363-365-369-370-375-379-383-386-64-65-66-67-68-69-70-71-72-73	91490-40030-00	REC91490-40030-00		93102-30M56	REC93102-30M56	233
		292-303-307-311-315-323-283-285-287-289-291-299-327-331-335-337-341-343-345-346-347-348-350-353-355-357-359-361-363-365-369-370-375-379-383-386-64-65-66-67-68-69-70-71-72-73	91690-30010	PAGB/T879.4-3X20		93102-32M07	REC93102-32M07	229-239
		292-303-307-311-315-323-283-285-287-289-291-299-327-331-335-337-341-343-345-346-347-348-350-353-355-357-359-361-363-365-369-370-375-379-383-386-64-65-66-67-68-69-70-71-72-73	91810-03014	PAF15-07000001		93102-35M13	REC93102-35M13	245-247
		292-303-307-311-315-323-283-285-287-289-291-299-327-331-335-337-341-343-345-346-347-348-350-353-355-357-359-361-363-365-369-370-375-379-383-386-64-65-66-67-68-69-70-71-72-73	92-858026QB1	RM92-858026QB1U6		93102-35M18	REC93102-35M18	235
		292-303-307-311-315-323-283-285-287-289-291-299-327-331-335-337-341-343-345-346-347-348-350-353-355-357-359-361-363-365-369-370-375-379-383-386-64-65-66-67-68-69-70-71-72-73	92-858027QB1	RM92-858027QB1U3		93102-35M47	PAF25-05020002	193-199
		292-303-307-311-315-323-283-285-287-289-291-299-327-331-335-337-341-343-345-346-347-348-350-353-355-357-359-361-363-365-369-370-375-379-383-386-64-65						

R.O. / OEM	REF		R.O. / OEM	REF		R.O. / OEM	REF	
93102-40M14	REC93102-40M14	245-247	93210-59MG7	REC93210-59MG7	154-156-301-305-309-313-361	93311-636U6	REC93311-636U6	241-257-258
93102-43M42	PAF25-05020003	193-195-199-201-203-207	93210-60MA3	REC93210-60MA3	357	93311-83280	REC93311-83280	331-335-337-383-399-400
93102-48009	REC93102-48009	209	93210-62269	REC93210-62269	239-243	93311-832U4	REC93311-832U4	239-258
93102-60004	REC93102-60004	211	93210-64488	REC93210-64488	333-335	93311-85894	REC93311-85894	335
93102-63008	REC93102-63004	213	93210-64ME7	REC93210-64ME7	295-355	93311-928U5	REC93311-928U5	329-381-397-398-399-400
93103-09M41	PAF2.6-03000004	283	93210-65M50	REC93210-65M50	233-235-241-295-355	93311-940U3	REC93311-940U3	245-247-258-259
93103-10052	REC93103-10052	343	93210-66M98	REC93210-66M98	359-365-369	93311-940V0	REC93311-940V0	247
93103-11051	REC93103-11051	343	93210-69MG6	REC93210-69MG6	299-303-307-311-341-361	93314-314V8	REC93341-214U1	291
93104-16M01	REC93104-16M01	235-237	93210-74M35	REC93210-74M35	245-247	93315-017U4	REC93315-017U4	353-394-395
93104-16M04	REC93104-16M01	231	93210-74MG5	REC93210-74MG5	299-303-311-361	93315-217U0	REC93315-217U0	363-395
93104-18049	REC93104-18049	239	93210-85M97	REC93210-85M97	371	93315-22004	REC93315-22004	295-353-355-357-394-395
93104-20M02	REC93104-20M02	243	93210-85M97-00	REC93210-85M97	373	93315-220V7	PAGB/T290F-2020	297
93104-22M07	REC93104-22M07	335	93210-86M38	REC93210-86M38	155-156-157-325-329-333-339-377-381-385-386	93315-220V7	REC93315-220V7	355-357-394-395
93106-09014	REC93106-09014	305-309-313-317-321-325-329-333-335-339-369-371-377-381-385	93210-86M39	REC93210-86M39	315-319-323-375	93315-314V8	REC93315-314V8	291-292-351-393-394
93106-09014-00	REC93106-09014	373	93210-94003	REC93210-94003	335-341	93315-317U2	REC93315-317U2	291-293-349-351-393-394
93106-18M01	REC93106-18M01	241	93210-97M55	REC93210-97M55	327-379	93315-32224	REC93315-32224	301-305-309-313-359-361-367-369-394-395-396
93109-44M00	REC93109-44M00	132	93211-04001	REC93211-04001	245-247	93315-324U1	REC93315-324U1	363-395
93110-23M00	REC93110-23M00	227	93211-04384	REC93211-04384	331-337-383	93315-325V1	REC93315-325V1	371-394-395-396
93210-05001	PAF2.6-03000009	283	93304-205U0	REC93304-205U0	257	93315-325V1-00	REC93315-325V1	373
93210-06ME6	REC90430-08020	295	93306-001U1	REC93306-001U1	299-303-307-311-361-394-395-396	93315-425U7	REC93315-425U7	323-375-396-397
93210-06ME6	REC93210-06ME6	289-291-292-297-301-351-361	93306-004U0	PAGB/T276-6004C2	345	93315-425V3	REC93315-425V3	327-379-397-398-399-400
93210-07003	REC93210-07540	329	93306-004YH	PAGB/T276-6004C2	289	93315-43061	REC93315-43061	327-331-335-379-383-397-398-399-400
93210-09004	PAF2.6-04060002	171	93306-005019	REC93306-005019	291-293-349-351-393-394	93315-430U8	REC93315-430U8	323-375-396-397-398-399-400
93210-12MG9	PAF25-05050013	193-199-207-64-65-68-69-70-71-180-187-195-201-203-205	93306-00612	PAGB/T276-6006/P6	347-393	93315-430V5	REC93315-430V5	396-397-398-399-400
93210-13M63	PAGB/T3452.1-13X2	187-195-201-203-205	93306-00612	REC93306-00612	295	93315-628U9	REC93315-628U9	325-377-396-397-398
93210-14515	PAF25-05050014	193-199-207	93306-00702	REC93306-00702	353-355-357-394-395	93316-003Y0	PANTN16003EY	283
93210-19MJ1	REC93210-19MJ1	211-213	93306-20401	REC93306-204Y7	359-365-369-394-395-396	93317-22204	REC93317-22204	299-303-307-311-359-361-365-369-394-395-396
93210-22164	PAGB/T3452.1-25.8X2	355	93306-204U0	REC93306-204U0	221-223	93317-322V0	REC93317-322V0	315-319-396-397
93210-22M02	REC93210-22M02	235	93306-205B2	PANTN6205C3	179	93317-325U0	REC93317-325U0	315-319-371-396-397
93210-24M79	PAF4-04000008	177-180-185-201-203-205-64-65-69-70-171-181-187-191-195-197-207-209-211-213-214	93306-205U7	REC93306-205U7	257	93317-325U0-00	REC93317-325U0	373
93210-24M79	PAJASOF40431-025	211-213	93306-205YD	PAGB/T276-6004C2	227-257	93317-330U2	REC93317-330U2	325-329-333-359-377-381-385-396-397-398-399-400
93210-25552	REC93210-25552	297-355	93306-206U5	PAGB/T5783-M5X12	183	93322-00001	REC93322-00001	299-303-307-361-365-369-394-395-396
93210-26130	PAGB/T3452.1-25.8X2	297-355	93306-207U0	REC93306-206U5	243-258	93322-00003	REC93322-00003	291-293-295-349-351-353-355-393-394-395
93210-32738	PAGB/T3452.1-32.5X1.8	65-66-67-68-69-70-71	93306-207U0-00	REC93306-207U0	315-319-371-395-396-397	93322-00005	REC93322-00005	394-395-396
93210-32738	REC93210-32738	65-66-68-69	93306-208U0	REC93306-208U0	373	93322-00048	REC93322-00048	327-331-397-398-399-400
93210-33M49	PAJASOF404-19-033	335-339	93306-209U0	REC93306-209U0	245-247-258-259-323-375-393-397	93322-00079	PAT40-04000027	367
93210-33M85	PAJASOF404-19-033	283	93306-209U1	REC93306-209U1	327-335-379-397-398-399	93322-00092	PAKOYOH1-CAP322/32	311
93210-33M85	PAJASOF404-19-033	64-154	93306-210U0	REC93306-210U0	400	93322-000A5	REC93322-000A5	335
93210-33MG4	REC93210-33MG4	301-305-309-313-361	93306-210U0	REC93306-210U0	331-337-383-399-400	93322-000U0	REC93322-000U0	363-395
93210-33MH2	PAF25-05050015	193-199-207	93306-240U0	REC93306-240U0	225-257	93322-000U3	REC93322-000U3	317-321-371-396-397
93210-35537	PAF4-04060002	171-177	93306-272Y2	PAGB/T276-62/22/P6	171	93322-000U5	REC93322-000U5	373
93210-35537	PAGB/T345.2-D32.5XD1	179	93306-303V1	REC93306-306V1	235	93322-000U7	REC93322-000U7	323-375-396-397
93210-37160	REC93210-37160	325-329-333-335-339-341-377-381	93306-304U0	REC93306-304U0	257	93322-000U8	REC93322-000U8	233-235-258
93210-37M67	REC93210-37M67	385-386	93306-305-U8	REC93306-305U8	237-258	93322-000V3	REC93322-000V3	327-379-397-398-399-400
93210-41042	REC93210-41042	357-359-367-369	93306-305U10	REC93306-305U10	257-258	93322-000W1	REC93322-000W1	331-337-383-399-400
93210-42101	REC93210-42101	343	93306-305U3	REC93306-305U3	229-231-257-258	93322-000W5	PAH1-CAP32004JRKYOYO	297
93210-42159	REC93210-42159	223-225-231-239	93306-306V1	REC93306-306V1	241-257-258	93322-000W7	REC93322-000W7	371-394-395-396
93210-42M70	REC93210-42M70	225	93306-307U0	REC93306-307U0	233-235-258	93322-000W7-00	REC93322-000W7-00	373
93210-44398	PAJASOF404-31-045	351	93310-112V0	REC93310-112V0	221-223-257-262	93322-000WS	REC93322-000WS	355-394-395
93210-44398	REC93210-44398	154-155-289-291	93310-32337	REC93310-32337	247-265	93340-67011	REC93340-67011	335-341
93210-45161	PAF25-04050003	66-154-155-297-355	93310-32337	REC93310-32337	258-259	93341-214U1	REC93341-214U1	348-393-394
93210-45161	REC93210-45161	155	93310-323V6	REC93310-323V6	245	93341-41414	REC93341-41414	351-393-394
93210-46044	REC93210-46044	317-321-371	93310-32668	REC93310-32668	247	93341-93020	REC93341-93020	333-385
93210-46044-00	REC93210-46044	373	93310-326V4	REC93310-326V4	259	93341-930U9	REC93341-930U9	339
93210-46M16	REC93210-46M16	227-229-241-243	93310-418U0	REC93310-418U0	225-257	93342-624U0	REC93342-624U0	363
93210-48001	PAJASOF40424-050	313	93310-418V1	REC93310-418V1	221-223-257	93390-000U2	REC93390-000U2	397-398-399
93210-48214	PAJISB2401P48	283-285	93310-522W0	REC93310-522W0	257-258	93390-000U0	REC93390-000U0	363-395
93210-48214	REC93210-48214	287-341-345	93310-527W1	REC93310-527W1	258	93399-99951	REC93399-99951	229-257
93210-48MG8	REC93210-48MG8	301-309-361	93310-620V5	REC93310-620V5	227-257	93420-22M03	PAGB/T893.1-22	287
93210-49046	REC93210-49046	154-289-293-317-321-346-359-369-371	93310-62406	REC93310-624U5	229-257-258			
93210-49046-00	REC93210-49046	373	93310-636U4	REC93310-636U4	243-258			
93210-53M08	REC93210-53M08	289-346	93310-727U0	REC93310-727U0	233-258			
93210-54534	REC93210-54534	333-339-385	93310-727V7	REC93310-727V7	235-258			
93210-54M54	REC93210-54M54	223	93310-730V6	REC93310-730V6	258			
93210-55M14	REC93210-54534	325-329-377-381	93310-730V8	REC93310-730V8	239-243-258			
93210-56M80	PAF15-06080003	231-291-293-351	93310-835U8	REC93310-835U8	243-258			
93210-57M00	REC93210-57M00	363	93310-836U0	REC93310-836U0	258-259			
93210-57M09	REC93210-57M09	291-293-349-351	93310-836V2	REC93310-836V2	245-247-258-259			
93210-58144	REC93210-58677	325-329-377-381	93310-954U1	REC93310-954U1	245-247-258-259			
93210-58677	REC93210-58677	347	93310-954V3	REC93310-954V3	258-259			
93210-58M21	REC93210-58M21	229-237	93310-959U0	REC93310-959U0	247			
			93311-632U1	REC93311-632U1	239-258			
			93311-632U2	REC93311-632U2	231-257			
			93311-632V4	REC93311-632V4	257-258			



R.O. / OEM	REF		R.O. / OEM	REF		R.O. / OEM	REF	
93430-06005	PAGB/T896-86	343	94702-00271-00	NGKBR7HS-10	108	97513-06525	PAGB/T5783-M6X25	185
93430-10M00	PAGB/T896-9	132	94702-00272	NGKBR7HS	221-233	97575-06520	PAGB/T5783-M6X20	293
93440-08819	PAF2.6-03000012	283	94702-00274	NGKBR6HS-10	64-65-180-223	97575-08530	PAGB/T5783-M8X30	293
93440-52008	REC93440-52009	227	94702-00274-00	NGKBR6HS-10	108	97575-08550-00	PAGB/T5783-M5X12	183
93440-68M03	REC93440-68M03	233-235	94702-00309	NGKBR9HS-10	245	97575-08550-00	PAGB/T5787-1986	177
93450-13022	REC93450-13022	221-223-225-262	94702-00372	NGKCR6HSB	64-173-179	97595-06520	PAGB/T5783-M6X20	185-187
93450-13130	PAF2.6-04020006	173	94702-00372-00	NGKCR6HS	108	97595-06520	PAGB/T97.1-8	183-191
93450-14088	PAF4-04020006	175-219	94702-00391	NGKLF5A-11	69-70-71-72-209-211	97595-06520	PAGB/T97.1-8	191-193-283
93450-15023	PAF15-07020005	183-219	94702-00391-00	NGKLF5A-11	108	97607-04210	PAGB/T818-M4X10	187
93450-15023	REC93450-15023	227-262	94702-00396	NGKBR8ES-11	108	97780-40112	PAGB/T845-ST4.2X16	349
93450-17129	PAF20-05020002	189-219	94702-00400	NGKLF6A-11	70-72-73-213-214	97780-50510	PAGB/T845-ST4.8X9	349
93450-17129	PAF25-05020106	193-195-199-201-203-205-207-219-231	94702-00400-00	NGKLF6A-11	108	97880-05025	PAGB/T818-M5X25	173-179-203-205
93501-04011	REC93501-04011	331-335-337-341-383	94702-00404-00	NGKBKR7EJU	108	97880-05025-00	PAGB/T818-M5X25	175
93503-16003	REC93503-16003	315-319-323-327-373-375-379	94702-00405-00	NGKBKR6EJU	108	98503-04066-00	PAGB/T818-M4X6	177
93507-32009	REC93507-32031	323-327	94702-00409	NGKCR9EB	108	98507-04010	PAGB/T818-M4X10	195-197-201-203-205-207
93507-32031	REC93507-32031	375-379	94702-00418	NGKDP6EB-9	65-66-67-68-69-187-195-201-203	98580-06016	PAGB/T818-M6X16	365
93511-32017	REC93511-32027	327	94702-00418-00	NGKDP6EB-9	108	98780-04015	PAGB/T820-M4X12	213-239
93511-32027	REC93511-32027	323-375-379	94702-00429-00	NGKDKR7E	69-205	98780-04016	PAGB/T818-M4X12	187-209-237
93602-14104	REC93602-14104	227-257-262	94702-00437-00	NGKDKR7E	108	98780-05016	PAGB/T818-M5X16	211
93602-14118	REC93602-14118	225-257-262	94702-00440	NGKDKR6E	71-108	98980-05025	PAGB/T818-M5X25	187
93602-18M12	REC93602-18M12	229	947395-06040	NGKDKR6E-9N	70	99001-06600	PAGB/T896-86	283-285-345
93602-20M02	REC93602-20M02	229-237-257-258-263-264-241-257-258-262-264	947395-06040	PAGB/T5782-M6X45	349	99001-06600	REC99001-06600	287-346
93603-18M09	REC93603-18M09	265	95380-05600	PAGB/T889.1-M5	299-303-307-311-365	99001-08600	REC99001-08600-00	305-309-313-317-321-325-329-333-335-339-369-371-377-381-385
93603-21111	REC93310-32337	265	95380-06700	REC95380-06700	301-361	99080-10600	PAGB/T896-9	132
93603-21111	REC93603-21111	233-235-239-243-258-259-263-264-265	95817-06012	PAGB/T5783-M6X12	171	99510-10114	PAF15-07000001	180-183-185
93604-07M13	PAF2.6-03000013	64-154-283	95895-06012	PAGB/T5783-M6X12	177	99510-10114	PAF4-04000003	175-177-179
93604-08062	PAF25-04000007	214-223-239-301-305-309-313-349-357-363-367	95895-06012	PAGB/T5783-M6X14	287	99530-08012	PAF25-00000014	191-197-201-203-205-207
93604-09066	PAF4-03000016	64-154-285-287-345	95895-06016	PAGB/T5783-M6X35	343-347	99590-10114	REC99590-10114	337-383
93604-09068	PAF2.6-03000013	343	95895-06016	PAGB/T5783-M5X12	287-289	99999-02808	REC99999-02808	134
93604-10M03	PAF15-00000013	201-317-351	95895-06016-00	PAGB/T5783-M5X12	285	99999-03116	PAF15-01010301S	131
93604-10M03	PAF25-04000007	195-203-205-297-321-355-371	95895-06020	PAGB/T5783-M5X12	283	99999-03249	PH130-0007	111
93604-12M07	PAF15-00000013	171-173-283-289-291-293-351	95895-06035	PAGB/T5783-M6X125	295	99999-03938	PH130-0051	110
93604-12M07	PAF15-07000013	183	95895-06035	PAGB/T5783-M6X30	293	CS3-43880-00	PH200-T036	122
93604-18080	PAF4-03000013	283-285-287-345	970-95-06030	PAGB/T5783-M6X30	231	F5-85570-13	REC6F5-85570-11	105
93605-14143	PAF25-05050016	193-199-207	97013-05010	PAGB/T5783-M5X10	179	JA9-12153-00	PA166F-000001	173-175-179
93606-11M24	REC93606-12019	297	97013-06012	PAGB/T5783-M6X12	189	K0A-A3721-00	RECK0A-A3721-00	209
		187-195-201-203-207-209-211-213-214-221-227-229-231-237-299-303-307-311-315-319-325-329-333-335-339-341-349-367-371-377-381-385	97013-06035	PAF15-07000030	197	K0A-A3722-00	RECK0A-A3722-00	209
			97013-06035	PAGB/T5782-M6X125	193	MAR-24563-00	RACS3213	78
			97013-06040	PAGB/T5782-M6X125	285	MAR-6YT30-02-12	SOL3231-101-13	402
			97013-06045	PAF20-05010007	187	N26-13440-00	REC26-13440-00	83-214
			97075-08025	PAGB/T5783-M8X25	171	N26-13440-02	REC26-13440-00	73-83
			97075-08035	PAGB/T5783-M8X35	289	N51-11325-01	TEN01160T	167
			97075-10040	REC97075-10040	299-303-307-311-319-369-370	YMD-63021-01	REC2TU3	84
			97080-08025	PAGB/T5783-M8X25	289-291-292-351	YMD-63021-04	REC2TU3	84
			97080-08045	REC97080-08045	289-291-351	YMD-63050-01	REC10W30U6	84
			97090-06014	PAGB/T5783-M6X16	343	YMD-63050-04	REC10W30U3	84
			97095-05012	PAGB/T5783-M5X12	191	YMD-63060-01	REC10W40U6	84
			97095-05012	PAGB/T818-M5X12	197-203-205-207	YMD-63060-04	REC10W40U3	84
			97095-05016	PAGB/T5783-M5X16	343	YMD-RCBOX-00-10	GS40015	127
			97095-0512	PAGB/T5783-M5X12	183	YMM-21005-00-00	PRE3300C05	130
			97095-06010	PAGB/T5783-M6X10	197-349-363	YMM-21006-C8-00	PRE3300C06	130
			97095-06016	PAGB/T5783-M6X16	221-223-225-227-231-235-239-321-339	YMM-21007-C8-00	PRE3300C07	130
			97095-06016	PAGB/T97.1-6	371	YMM-21008-C8-00	PRE3300C08	130
			97095-06020	PAGB/T5783-M6X20	171-173-179-180-191-195-197-201-203-205-207-209-213-233-237-241-291-347-351	YMM-21009-C8-00	PRE3300C09	130
			97095-06020-00	PAGB/T5783-M6X20	175	YMM-21010-C8-00	PRE3300C10	130
			97095-06025	PAGB/T5782-M6X25	209-213-231	YMM-21011-C8-00	PRE3300C11	130
			97095-06030	PAGB/T5783-M6X30	180-211-213-343-346	YMM-21012-C8-00	PRE3300C12	130
			97095-06030	REC90101-06M56	209	YMM-21013-C8-00	PRE3300C13	130
			97095-06035	PAGB/T5783-M5X12	185	YMM-21014-C8-00	PRE3300C14	130
			97095-06040	REC97095-06040	347-355	YMM-21015-C8-00	PRE3300C15	130
			97095-06045	REC97095-06045	211-287-346	YMM-21016-C8-00	PRE3300C16	130
			97095-08014	PAGB/T5783-M8X14	171-179	YMM-21017-C8-00	PRE3300C17	130
			97095-08020	PAF4-04000001	331-335-337-341	YMM-21018-C8-00	PRE3300C18	130
			97095-08020	PAGB/T5783-M8X20	179	YMM-21019-C8-00	PRE3300C19	130
			97095-08020-00	PAF4-04000001	177	YMM-21020-C8-00	PRE3300C20	130
			97095-08020-00	PAGB/T5783-M8X20	177	YMM-21022-C8-00	PRE3300C21	130
			97095-08025	PAGB/T5783-M8X25	299-303-307-311-325-329-333-339	YMM-21024-C8-00	PRE3300C22	130
			97095-08035	PAGB/T5783-M8X35	303-307-311	YMM-21025-C8-00	PRE3300C23	130
			97095-08045	REC97095-08045	293-363-367-369	YMM-21026-C8-00	PRE3300C24	130
			97095-08055	REC97095-08055	363-367-369	YMM-21028-C8-00	PRE3300C25	130
			97395-06020	PAGB/T5783-M6X20	349	YMM-2W114-00	PRE3300C26	130
			97395-08045	REC97095-08045	359	YMM-2W227-01	PRE3300C27	130
			97395-08055	REC97095-08055	359	YMM-2W227-01	PRE3300C28	130
			97395-08070-00	REC97395-08070	373	YMM-2W227-01	PRE3300C29	130
						YMM-21030-C8-00	PRE3300C30	130
						YMM-2E114-00	RACS3240	79
						YMM-2E227-00	RACS3227	79
						YMM-2E227-01	RACS3227	79
						YMM-2FE08-00	GS31166	79
						YMM-2FE10-00	GS31065	79
						YMM-2FS08-00	GS31066	79
						YMM-2FS10-00	GS31067	79
						YMM-2W114-00	RAC120R-RAC-01	79
						YMM-2W227-01	RAC320R-RAC-01	78
						YMM-2W227-01	RAC490R-RAC-01	79

## BARCELONA

Jocelyn Bell, 26  
Pol. Ca n'Alemanya  
08840 Viladecans (Barcelona)  
Tel. 902 10 85 85 - 93 633 34 80  
Fax 93 662 66 59

International  
phone: (+34) 93 662 66 55  
Fax (+34) 93 662 66 59

info@recambiosmarinos.es  
www.recambiosmarinos.es

## GIRONA

C/ Gironés, 5  
Pol. Ind. El Plà  
17486 Castelló d'Empúries (Girona)  
Tel. (+34) 972 158 809

girona@recmar.es

## CANARIAS

Laura Grote de la Puerta, 3, Nave 5  
Pol. Industrial El Mayorazgo  
38110 Santa Cruz de Tenerife  
Tel. (+34) 922 621 499

canarias@recmar.es

## ITALIA

RECMAR SRL  
Via Israele 10 H  
Zona Industriale Settore 7  
07026 Olbia (OT)

Tel. (+39) 0789 51962  
Fax (+39) 0789 600177  
sales@recmar.it