

**RECAMBIOS  
MARINOS**

# TOHATSU

FUERABORDA • OUTBOARD • FUORIBORDO • HORS-BORD

2021  
2022



[www.recambiosmarinos.es](http://www.recambiosmarinos.es)

# TOHATSU

**ES**

GUÍA MANTENIMIENTO	589	IGNICIÓN	599	DESPIECE MOTOR DE 4 TIEMPOS	613
<b>SISTEMA DE ALIMENTACIÓN Y FILTRACIÓN</b>	590	CARGA	599	MFS8 • MFS9.9	613
ACEITE	595	BUJÍAS	600	<b>DESPIECE MOTOR DE 2 TIEMPOS</b>	608
BOMBA DE COMBUSTIBLE EN LÍNEA	590	CDI Y CAJAS NEGRAS	601	M4C • M5B • M5BS	608
ABRAZADERA PARA MANGUERA	591	MOTORES DE ARRANQUE	600	M6B • M8B • M9.8B	609
ADAPTADOR LÍNEA DE COMBUSTIBLE	591	SENSORES	598	M9.9D • M15D2 • M18E2	610
BOMBA DE COMBUSTIBLE	590	SENSOR PRESIÓN ACEITE	598	M25C3 • M30A4	611
LÍNEA DE COMBUSTIBLE	590	SENSOR DE OXÍGENO	598	M40D2 • M50D2	612
MANGUERA DE COMBUSTIBLE	590	SENSOR ÁRBOL DE LEVAS	598	<b>JUNTAS DE MOTOR 4 TIEMPOS</b>	617
MUELLE TUBO COMBUSTIBLE	591	TRIM, TILT & POWER TRIM	602	JUNTAS BASE DE MOTOR	618
BOMBA DE COMBUSTIBLE	596	INSTALACIÓN ELÉCTRICA	602	JUNTAS CULATÍN	617
KITS MEMBRANAS Y JUNTAS	596	POWER TRIM COMPLETO	602	JUNTAS DE CULATA	617
<b>CARBURADOR</b>	596	TRIM COMPLETO	602	KIT JUNTAS DE CULATA	617
BOYAS	597	<b>SISTEMA DE GOBIERNO</b>	603	PISTONES	619
CARBURADOR COMPLETO	596	COMPONENTES	603	KIT DE PISTONES	619
KITS CARBURADORES	597	CABLES DE ACELERADOR	603	RETENES DE ACEITE	618
<b>COMPONENTES TANQUE Y CONECTORES</b>	591	<b>SISTEMA DE REFRIGERACIÓN</b>	603	<b>SISTEMA DE ESCAPE Y ADMISIÓN</b>	621
CONECTOR DE DEPÓSITO	591	ÁNODOS	606	SISTEMA DE ADMISIÓN	621
PASAMAMPAROS	592	ÁNODO CANADA METAL	606	JUNTAS DE ADMISIÓN	621
FILTRO DE ACEITE	596	ÁNODO TECNOSEAL	607	<b>SISTEMA DE ESCAPE</b>	621
FILTRO DE COMBUSTIBLE Y ELEMENTOS	592	BOMBA DE AGUA	605	JUNTAS DE ESCAPE	621
BRACKET	592	CASQUILLO INOX	605	<b>UNIDADES DE TRANSMISIÓN</b>	622
FILTRO DECANTADOR DE COMBUSTIBLE COMPLETO CON VASO TRASPARENTE	593	JUNTAS BOMBA	605	DESPIECE COLAS 4 TIEMPOS	622
FILTRO DECANTADOR DE GASOLINA	593	JUNTAS BASE DE BOMBA	605	MFS8 • MFS9.8	622
FILTRO COMBUSTIBLE MONTAJE EN LÍNEA	594	KITS DE REPARACIÓN BOMBA DE AGUA	605	GUÍA PIEZA DE COLA	626
FILTRO COMBUSTIBLE SEPARADOR AGUA	592	IMPULSORES	604	<b>SISTEMA DE PROPULSIÓN</b>	627
LLAVES PARA FILTRO	594	TERMOSTATO	603	HÉLICES ALUMINIO E INOXIDABLE DE 3 Y 4 PALAS	627
RACOR DE LATÓN	594	JUNTAS TAPA DE REFRIGERACIÓN	604	GUÍA HÉLICES CON NÚCLEO INTEGRADO	628
<b>SISTEMA ELÉCTRICO</b>	598	JUNTA TERMOSTATO	604	HÉLICES PARA NÚCLEO INTERCAMBIABLE	629
BOBINAS	598	<b>PARTES DEL MOTOR</b>	608	NÚCLEO INTERCAMBIABLE	629
ALTA PRESIÓN	599	CIGÜEÑAL	619	REF --> RO	630
PULSACIÓN	599	RODAMIENTOS	619	RO --> REF	

**EN**

DRIVES MAINTENANCE GUIDE & KITS	589	IGNITION COIL	599	ENGINE GASKETS 4 STROKES	617
<b>FUEL &amp; FILTRATION SYSTEM</b>	590	CHARGER COIL	599	GASKET, CYLINDER COVER	617
CARBURATOR	596	SENSORS	598	GASKET, CYLINDER HEAD	617
CARBURETOR KITS	597	SENSOR, OIL PRESURE	598	GASKET KIT, CYLINDER HEAD	617
FLOATS	597	SENSOR, OXYGEN	598	<b>ENGINE PARTS 2 STROKES</b>	608
FULL CARBURATOR	596	SENSOR, CAMSHAFT	598	M4C • M5B • M5BS	608
<b>FUEL FILTERS AND ELEMENTS</b>	592	SPARK	600	M6B • M8B • M9.8B	609
BRACKET	592	STARTERS	600	M9.9D • M15D2 • M18E2	610
COMPLET FUEL FILTER	594	TRIM, TILT & POWER TRIM	602	M25C3 • M30A4	611
COMPLET FUEL FILTER WITH TRANSPARENT BOWL	593	COMPLETE POWER TRIM ASSEMBLY	602	M40D2 • M50D2	612
FILTER KEY	594	COMPLETE TRIM ASSEMBLY	602	<b>ENGINE PARTS 4 STROKES</b>	613
IN-LINE FUEL FILTER	594	WIRING HARNESS	602	MFS8 • MFS9.9	613
RACORS	594	<b>STEERING SYSTEM</b>	603	PISTONS	619
WATER SEPARATING FUEL FILTER	592	COMPONENTS	603	PISTON KITS	619
<b>FUEL PUMP</b>	596	CONTROL CABLES	603	<b>OIL SEALS</b>	618
DIAPHRAGMS & GASKETS	596	<b>COOLING SYSTEM</b>	603	<b>EXHAUST &amp; INTAKE SYSTEM</b>	621
<b>FUEL PUMP IN LINE</b>	590	ANODES	606	EXHAUST SYSTEM	621
CLAMP SMALL	591	ANODES CANADA METAL	606	GASKETS	621
COUPLER	591	ANODES TECNOSEAL	607	<b>INTAKE SYSTEM</b>	621
FUEL HOSE	590	IMPELLERS	604	GASKETS	621
FUEL LINE ASSEMBLY	590	TERMOSTAT	603	<b>UNIT DRIVES &amp; COMPONENTS</b>	622
SPRING, FUEL PIPE	591	GASKET BASE	603	DRIVE COMPONENTS GUIDE	626
<b>FUEL TANK COMPONENTS &amp; CONNECTORS</b>	591	EXHAUST INNER COVER	604	GEAR CASE PARTS 4 STROKES	622
TANK CONNECTOR	591	<b>WATER PUMP</b>	605	MFS8 • MFS9.8	622
THRU HULL	592	GASKET	605	<b>PROPULSION SYSTEM</b>	627
<b>OIL</b>	595	GASKET BASE	605	3 & 4 BLADE ALUMINIUM & SS PROPELLERS	627
<b>OIL FILTER</b>	596	INSERT CUP	605	INTERCHANGEABLE HUB	629
<b>ELECTRIC SYSTEM</b>	598	SERVICE KIT	605	PROPELLERS APPLICATION WITH RUBBER HUB	629
CDI & POWER PACK	601	<b>ENGINE PARTS</b>	608	PROPELLERS FOR INTERCHANGEABLE HUB	629
COILS	598	CRANKSHAFT	619	REF --> OEM	630
COIL HIGH PRESSURE	599	CRANKSHAFT BEARINGS	619	OEM --> REF	632
PULSER COIL	599				

TOHATSU

RECAMBIOS MARINOS

## IT

GUIDA MANUTENZIONE E KIT	589	CDI E CENTRALINA	601	GUARNIZIONE BASE MOTORE	618
<b>SISTEMA DI ALIMENTAZIONE E FILTRAZIONE</b>	590	MOTORINI AVVIAMENTO	600	GUARNIZIONE TESTATA	617
CARBURATORE	596	SENSORE	598	GUARNIZIONE COPERCHIO TESTA	617
CARBURATORE COMPLETO	596	SENSORE PRESIONE OLIO	598	KIT GUARNIZIONE TESTATA	617
GALLEGGIANTE	597	SENSORE OSSIGENO	598	<b>PARAOILIO</b>	618
KIT CARBURATORI	597	SENSORE ALBERO A CAMME	598	<b>PARTI MOTORE 4 TEMPI</b>	613
<b>COMPONENTI SERBATOIO E CONNETTORI</b>	591	TRIM, TILT & POWER TRIM	602	MFS8 • MFS9.9	613
ATTACCO SERBATOIO	591	INSTALLAZIONE ELETTRICA	602	<b>PARTI MOTORE 2 TEMPI</b>	608
PASSASCAFO	592	MOTORINO POWER TRIM COMPLETO	602	M4C • M5B • M5BS	608
<b>FILTRI BENZINA E RACCORDI</b>	592	MOTORINO TRIM COMPLETO	602	M6B • M8B • M9.8B	609
CHIAVE DA FILTRO	594	<b>SISTEMA DI GUIDA</b>	603	M9.9D • M15D2 • M18E2	610
FILTRO BENZINA PER MONTARE IN LINEA	594	<b>COMPONENTI</b>	603	M25C3 • M30A4	611
FILTRO DECATATORE BENZINA	593	CAVO ACCELERATORE	603	M40D2 • M50D2	612
FILTRO DI DECANAZIONE BENZINA	593	<b>SISTEMA DI RAFFREDDAMENTO</b>	603	<b>PISTONE</b>	619
COMPLETO CON VASCHETTA TRASPARENTE	593	<b>ANODI</b>	606	KIT PISTONE	619
FILTRO SEPARATORE ACQUA-BENZINA	592	ANODI CANADA METAL	606	<b>SISTEMA DI SCARICO E ASPIRAZIONE</b>	621
RACCORDI	594	ANODI TECNOSEAL	607	<b>SISTEMA ASPIRAZIONE</b>	621
SUPPORTO	592	<b>GIRANTE</b>	604	GUARNIZIONE	621
<b>FILTRO OLIO</b>	596	GUIDA GIRANTE	604	<b>SISTEMA SCARICO</b>	621
OLIO	595	<b>POMPA ACQUA</b>	605	GUARNIZIONE	621
<b>POMPA BENZINA</b>	596	GHIERA INOX	605	<b>UNITÀ DI TRASMISSIONE</b>	622
MEMBRANA E GUARNIZIONI	596	GUARNIZIONE BASE POMPA	605	<b>GUIDA COMPONENTI PIEDI</b>	626
<b>POMPA BENZINA IN LINEA</b>	590	GUARNIZIONE POMPA	605	<b>PARTI PIEDI 4 TEMPI</b>	622
ADATTATORE	591	KIT RICAMBI POMPA ACQUA	605	MDF8 • MSF9.8	622
FASCETTE	591	<b>TERMOSTATO</b>	603	<b>SISTEMA DI PROPULSIONE</b>	627
MOLLA TUBO COMBUSTIBILE	591	GUARNIZIONE TERMOSTATO	604	<b>ELICHE ALLUMINIO E INOX DA 2 E 4 PALE</b>	627
POMPA BENZINA	590	GUARNIZIONE COPERCHIO	604	ELICHE PER MOZZO INTERCAMBIABILE	629
TUBO BENZINA	590	REFRIGERAZIONE	604	GUIDA ELICHE CON MOZZO	628
<b>SISTEMA ELETTRICO</b>	598	<b>PARTI MOTORE</b>	608	MOZZO INTERCAMBIABILE	629
<b>BOBINE</b>	598	ALBERO MOTORE	619	REF --> RO	630
BOBINA ALTA PRESSIONE	599	CUSCINETTI ALBERO MOTORE	619	RO --> REF	632
BOBINA ACCENSIONE	599	<b>GUARNIZIONI MOTORE 4 TEMPI</b>	617		
BOBINA AVVIAMENTO	599				
BOBINA DI CARICA	599				
<b>CANDELE</b>	600				

## FR

GUIDE MAINTENANCE KITS	589	BOBINE D'ALLUMAGE	599	JOINTS DE TÊTE MOTRICE	618
<b>SYSTÈME D'ALIMENTATION ET DE FILTRATION</b>	590	BOBINE DE CHARGE	599	KIT JOINTS DE MOTEUR	617
CARBURATEUR	596	<b>BOUGIES</b>	600	<b>PIÈCES MOTEURS DE 4 TEMPS</b>	613
CARBURATEUR COMPLET	596	CAPTEURS	598	MFS8 • MFS9.9	613
FLOTTEUR DE CARBURATEUR	597	CAPTEUR PRESION HUILE	598	<b>PIÈCES MOTEUR 2 TEMPS</b>	608
KIT CARBURATEUR	597	CAPTEUR À OXYGENE	598	M4C • M5B • M5BS	608
<b>COMPOSANTS ET CONNECTEURS DU RÉSERVOIR</b>	591	CAPTEUR DE POSITION D'ARBRE À CAMES	598	M6B • M8B • M9.8B	609
PASSE-CLOISON	592	<b>CDI ET BOITIER ELECTRONIQUE</b>	601	M9.9D • M15D2 • M18E2	610
RACCORDS DE RESERVOIR	551	DEMARREUR	600	M25C3 • M30A4	611
<b>FILTRE À ESSENCE ET CARTOUCHE DE RECHANGE</b>	592	TRIM, TILT & POWER TRIM	602	M40D2 • M50D2	612
CLÉ À FILTRE	594	INSTALLATION ELECTRIQUE	602	<b>PISTONS</b>	619
FILTRE DÉCANTEUR ESSENCE	593	MOTEUR DE TRIM	602	KIT PISTON	619
FILTRE DÉCANTEUR ESSENCE AVEC BOL TRANSPARENT	593	POWER TRIM COMPLET	602	<b>VILEBREQUIN</b>	619
FILTRE À ESSENCE EN LIGNE	594	<b>SYSTÈME DE COMMANDE</b>	603	ROULEMENTS VILEBREQUIN	619
FILTRE SÉPARATEUR EAU-ESSENCE	592	<b>COMPOSANT</b>	603	<b>SYSTÈME D'ÉCHAPPEMENT ET SYSTÈME D'ADMISSION</b>	621
RACCORDS	594	CÂBLE D'ACCELERATEUR	603	<b>SYSTÈME D'ADMISSION</b>	621
TÊTE DE FILTRE À ESSENCE	592	<b>SYSTÈME DE REFROIDISSEMENT</b>	603	JOINTS	621
<b>FILTRE À HUILE</b>	596	<b>ANODES</b>	606	<b>SYSTÈME D'ÉCHAPPEMENT</b>	621
HUILES	595	ANODE CANADA METAL	606	JOINTS	621
<b>POIRE À CARBURANT</b>	590	ANODE TECNOSEAL	606	<b>EMBASES ET PIÈCES</b>	622
COLLIER	591	<b>TURBINES</b>	604	<b>PIÈCES D'EMBASES DE 4 TEMPS</b>	622
POIRE À CARBURANT	591	<b>POMPE D'EAU</b>	605	MFS8 • MFS9.9	622
RACCORD COUPLEUR	591	INSERT INOX	605	<b>GUIDE PIÈCES D'EMBASES</b>	626
RESSORT, TUYAU DE CARBURANT	591	JOINTS, BASE DE POMPE À EAU	605	<b>SYSTEME DE PROPULSION</b>	627
TUYAU CARBURANT	590	JOINTS POMPE	605	<b>HÉLICE ALUMINIUM ET INOX 3 ET 4 PALES</b>	627
<b>POMPE À ESSENCE</b>	596	KIT REPARATION DE POMPE À EAU	605	GUIDE DES HÉLICES ET MOYEUR	628
MEMBRANES ET JOINTS	596	<b>THERMOSTAT</b>	603	HELICES AVEC MOYEU INTERCHANGEABLE	628
<b>SYSTÈME ÉLECTRIQUE</b>	598	JOINT THERMOSTAT	604	MOYEU INTERCHANGEABLE	629
<b>BOBINES</b>	598	JOINT COUVERCLE THERMOSTAT	604	REF --> RO	630
BOBINE HAUTE PRESION	599	<b>PIÈCES MOTEUR</b>	608	RO --> REF	632
BOBINE PULSEUR	599	<b>JOINTS DE MOTEUR 4 TEMPS</b>	617		
		JOINTS COUVRE CULASSE	617		
		JOINTS DE CULASSE	617		

MAINTENANCE  
GUIDE

GUIDA  
MANUTENZIONE

GUIDE  
MAINTENANCE

	REF					
MFS4 MFS5 MFS6	NGKDCPR6E	BUJÍA	SPARK PLUG	CANDELE	BOUGIE	1
	TEN01259	ÁNODO	ANODE DRIVE	ANODO	ANODE	1
	CEF500377	IMPULSOR	IMPELLER	GIRANTE	TURBINE	1
	PAF4-05000300	FILTRO COMBUSTIBLE	FUEL FILTER	FILTRO BENZINA	FILTRE À ESSENCE	1
MFS8 MFS9.8	NGKDCPR6E	BUJÍA	SPARK PLUG	CANDELE	BOUGIE	2
	TEN01258	ÁNODO BLOQUE	ANODE ENGINE	ANODO MOTORE	ANODE MOTEUR	1
	CEF500344	IMPULSOR	IMPELLER	GIRANTE	TURBINE	1
	PAF4-05000300	FILTRO COMBUSTIBLE	FUEL FILTER	FILTRO BENZINA	FILTRE À ESSENCE	1
	REC855676002	TERMOSTATO	THERMOSTAT	TERMOSTATO	TERMOSTAT	1
	PAF8-05000004	CORREA DISTRIBUCIÓN	TIMING BELT	CINGHIE DISTRIBUZIONE	COURROIE DE DISTRIBUTION	1
	TEN01260	ÁNODO COLA	ANODE DRIVE	ANODO PIEDE	ANODE EMBASSE	1
MFS9.9 MFS15 MFS18	NGKDCPR6E	BUJÍA	SPARK PLUG	CANDELE	BOUGIE	2
	TEN01258	ÁNODO BLOQUE	ANODE ENGINE	ANODO MOTORE	ANODE MOTEUR	1
	CEF500383	IMPULSOR	IMPELLER	GIRANTE	TURBINE	1
	PAF4-05000300	FILTRO COMBUSTIBLE	FUEL FILTER	FILTRO BENZINA	FILTRE À ESSENCE	1
	REC5GH-13440-00	FILTRO ACEITE	OIL FILTER	FILTRO OLIO	FILTRE À HUILE	1
	REC855676002	TERMOSTATO	THERMOSTAT	TERMOSTATO	TERMOSTAT	1
	TEN01250	ÁNODO TRANSOM	TRANSOM ANODE	ANODO TRANSOM	ANODE TRANSOM	1
MFS25 MFS30	NGKDCPR6E	BUJÍA	SPARK PLUG	CANDELE	BOUGIE	2
	TEN01258	ÁNODO BLOQUE	ANODE ENGINE	ANODO MOTORE	ANODE MOTEUR	1
	CEF500382	IMPULSOR	IMPELLER	GIRANTE	TURBINE	1
	PAF4-05000300	FILTRO COMBUSTIBLE	FUEL FILTER	FILTRO BENZINA	FILTRE À ESSENCE	1
	REC855676002	TERMOSTATO	THERMOSTAT	TERMOSTATO	TERMOSTAT	1
	REC5GH-13440-00	FILTRO ACEITE	OIL FILTER	FILTRO OLIO	FILTRE À HUILE	1
	TEN01256	ÁNODO TRANSOM	TRANSOM ANODE	ANODO TRANSOM	ANODE TRANSOM	1
	TEN01253	ÁNODO COLA	ANODE DRIVE	ANODO PIEDE	ANODE EMBASE	1

# SISTEMA DE ALIMENTACIÓN Y FILTRACIÓN FUEL & FILTRATION SYSTEM

# SISTEMA DI ALIMENTAZIONE E FILTRAZIONE SYSTÈME D'ALIMENTATION ET DE FILTRATION

## BOMBA DE COMBUSTIBLE

## FUEL PUMP

## POMPA BENZINA

## POIRE À CARBURANT

### BOMBA DE COMBUSTIBLE

### FUEL PUMP

### POMPA BENZINA



### POIRE À CARBURANT

Fabricada con elastómeros termoplásticos inyectados, resistentes al alcohol y rayos UV.s

Premium quality bulb resistance to alcohol as well as UV and ozone.

Fabbricata con elastomero termoplastico, resistente ai solventi e raggi UV.

Fabriqué avec des élastomères thermoplastiques injectés, résistant à l'alcool et aux rayons UV.

REF		
GS31187	1/4" = 6 mm	1
GS31090	5/16" = 8 mm	1
GS31095	3/8" = 9.5 mm	1
GS31090	5/16" = 8 mm	1

**GOLDENSHIP**



### LÍNEA DE COMBUSTIBLE

### FUEL LINE ASSEMBLY

### TUBO CARBURANTE



### TUYAU CARBURANT

Universal. Manguera resistente al alcohol.



Universal. Alcohol resistant hose.

Universale. Tubo resistente ai solventi.

Universel. Tuyau résistant à l'alcool.



REF		
GS31096	5/16" x 2 m	1
GS31097	3/8" x 2 m	1
GS31099	8 mm x 2 m	1
SIE18-8013	5/16" x 2 m	1
SIE18-8015	3/8" x 2 m	1



REF		
GS31189	3/8" x 2 m	1

MADE IN THE USA **GOLDENSHIP**



REF		
GS31183	6 mm x 2 m	1

**GOLDENSHIP**

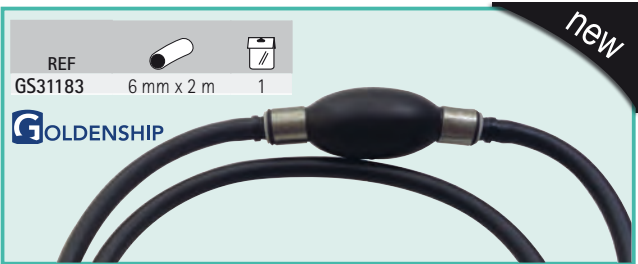

new

### MANGUERA DE COMBUSTIBLE

### FUEL HOSE

### TUBO BENZINA





### TUYAU CARBURANT

Manguera «Trident» para líneas de combustible. Con refuerzo termoplástico que le permite excelente flexibilidad y resistencia a los rayos UV. Color gris. Resistente al alcohol. Especialmente indicado para motores fueraborda. Garantía: 3 años

Marine fuel hose (distribution and vent) for outboards. Fuel resistant thermo-plastic formulation with 2 spiral reinforcement provides excellent bendability and resistance to UV, aging and permeation by all marine fuels (gasoline/petrol and diesel) including alcohol blends. Warranty: 3 years

Tubo «Trident» per linea combustibile. Con rinforzo termoplastico che gli permette un'eccellente flessibilità e resistenza ai raggi UV. Colore grigio. Resistente ai solventi. Indicato per i motori fuoribordo. Garanzia: 3 anni

Tuyau «Trident» pour carburant. Avec renfort thermoplastique qui permet une excellente flexibilité et résistance aux rayons UV. Gris. Résistant à l'alcool. Convient particulièrement aux moteurs hors-bord. Garantie: 3 ans

REF				
TRI305-0566	5/16" = 7,92 mm	15 m	1	SAEJ1527
TRI305-0386	3/8" = 9,53 mm	15 m	1	ISO-8469 B1 CE



**TRIDENT**

MADE IN THE USA **CE CERTIFIED**

De goma para diesel y gasolina sin plomo. Ideal para fueraborda. Refuerzos textiles internos. Muy flexible. Contenido aromático 50%

Rubber Hose suitable for loading mineral oils, diesel and unloaded fuel

In gomma per diesel e benzina senza piombo. Ideale per motori fuoribordo. Tessuto interno rinforzato. Molto flessibile.

Caoutchouc pour diesel et essence sans plomb. Idéal pour le hors-bord. Renforts textiles internes. Très flexible



### CARBUPOMP/10NL

REF						
GS35031	6x12	10 bar	50 mm	-25°C → 80°C	50 m	ISO R1307
GS35032	8x15	10 bar	65 mm		50 m	

H.T. - CARBUPOMP/10NL - WP 10 BAR - R-1M Q/m - ISO R1307

**ht**  
hoses technology

<b>MUELLE TUBO COMBUSTIBLE</b>	<b>SPRING, FUEL PIPE</b>	<b>MOLLA TUBO COMBUSTIBLE</b>	<b>RESSORT, TUYAU DE CARBURANT</b>	<b>new</b>
REF PAF4-04000030 PAF4-05000010				





<b>ABRAZADERA</b>	<b>CLAMP SMALL</b>	<b>FASCETTE</b>	<b>COLLIER</b>	<b>new</b>
REF REC650-24351-51 6 mm REC6E5-24351-51 8 mm		REF REC09401-11425 6-8 mm 1 REC09401-11425BULK 6-8 mm 25		

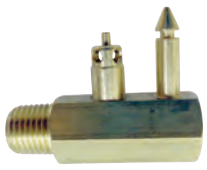

<b>ADPATADOR LÍNEA DE COMBUSTIBLE</b>	<b>COUPLER</b>	<b>ADATTATORE</b>	<b>RACCORD COUPLEUR</b>
REF REC22-8M0001721 Ø 11 mm --> Ø 9 mm			

<b>COMPONENTES TANQUE Y CONECTORES</b>	<b>FUEL TANK COMPONENTS &amp; CONNECTORS</b>	<b>COMPONENTI SERBATOIO E CONETTORI</b>	<b>COMPOSANTS ET CONNECTEURS DU RESERVOIR</b>
<b>CONECTOR DE DEPÓSITO LATÓN</b>	<b>TANK CONNECTOR BRASS</b>	<b>ATTACCO SERBATOIO OTTONE</b>	<b>RACCORDS DE RESERVOIR LAITON</b>
REF GS31068 1/4" NPT 1			

Para conectar dos motores a un sólo depósito, o viceversa. To connect two motors to a single tank, or vice versa. Per collegare due motori a un singolo serbatoio o viceversa. Pour connecter deux moteurs à un même réservoir, ou inversement.

REF GS31069 1/4" NPT 1		
---------------------------	---	---

REF GS31073 1/4" NPT			REF GS31020 1/4" NPT		
-------------------------	---	---	-------------------------	---	---

<b>CONECTOR DE DEPÓSITO</b>	<b>TANK CONNECTOR</b>	<b>ATTACCO SERBATOIO</b>	<b>RACCORDS DE RESERVOIR</b>
REF GS31088 3B2-702501M 3/8"	COMPATIBLE CON CONECTOR COMPATIBLE WITH CONNECTOR COMPATIBLE CON CONNETTORE COMPATIBLE AVEC CONECTEUR 2T STROKES 4T STROKES GS31019	REF GS31019 99998-OMA2 1/4" NPT	COMPATIBLE CON CONECTOR COMPATIBLE WITH CONNECTOR COMPATIBLE CON CONNETTORE COMPATIBLE AVEC CONECTEUR 2T STROKES 4T STROKES GS31088
5 ---> 90 HP 			

REF	OEM	2T STROKES	4T STROKES	COMPATIBLE CON CONECTOR COMPATIBLE WITH CONNECTOR COMPATIBILE CON CONNETTORE COMPATIBLE AVEC CONECTEUR
GS31016	3B2-702801M	3/8"	✓	GS31017

5 --> 90 HP

REF	OEM	2T STROKES	4T STROKES	COMPATIBLE CON CONECTOR COMPATIBLE WITH CONNECTOR COMPATIBILE CON CONNETTORE COMPATIBLE AVEC CONECTEUR
GS31017		1/4" NPT	✓	GS31016

5 --> 90 HP

REF	OEM	2T STROKES	4T STROKES	GOLDENSHIP
GS31018	3B2-702601M	Metrica	✓	

5 --> 90 HP

REF	OEM	2T STROKES	4T STROKES	GOLDENSHIP
GS31015	394-702500M	3/8"	✓	

PASAMAMPAROS	THRU HULL	PASSASCAFO	PASSE-CLOISON
Para atravesar mamparos de hasta 12 mm. Fabricado en latón.	For bulkhead up to 12 mm. Made in machined brass.	Per attraversare paratie fino a 12 mm. Fabricato in ottone.	Pour traverser des cloisons jusqu'à 12 mm. Fait en laiton.

REF	2T STROKES	4T STROKES
GS31064	3/8"	1

FILTRO DE COMBUSTIBLE Y ELEMENTOS	FUEL FILTERS AND ELEMENTS	FILTRI BENZINA E RACCORDI	FILTRE A ESSENCE ET CARTOUCHE DE RECHANGE
BRACKET	BRACKET	SUPPORTO	TÊTE DE FILTRE À ESSENCE
Con 2 tapones de bronce y 2 tubos de extensión. (2 entradas y 2 salidas).	With 2 brass plugs and 2 extension tubes. (2 inputs & 2 outputs).	Con 2 tappi di bronzo e 2 tubi di estensione. (2 ingressi entrata carburante e 2 uscite carburante).	Avec 2 bouchons en bronze et 2 tubes d'extension. (2 entrées et 2 sorties).

REF	2T STROKES	4T STROKES
REC25000	1/4"	AL
REC25010	1/4"	INOX /SS AISI316
REC25020	3/8"	AL
REC25030	3/8"	INOX /SS AISI316
RECOBBRACKET	1/4"	Plástico   Plastic Plastica   Plastique

REC25000 - REC25020      REC25010 - REC25030      RECOBBRACKET

FILTRO COMBUSTIBLE SEPARADOR DE AGUA	WATER SEPARATING FUEL FILTER	FILTRO SEPARATORE ACQUA-BENZINA	FILTRE SEPARATEUR EAU-ESSENCE
REC24942	10 MICRON		
REC35-802893Q01	3Y7-02234-0		
REC855686	28 MICRON		
REC35-802893Q	25 MICRON		
RACPF5510	10 MICRON		

RACPF5510      REC24942      REC35-802893Q01      REC855686      REC35-802893Q



Filtro original.	OEM filter.	Filtro benzina originale.	Filtre à essence d'origine
REF	MICRON		
RM35-802893Q	10		

**FILTRO CON BRACKET**  
Con 2 tapones de bronce y 1 tubo de extensión.

**OEM FILTER WITH BRACKET**  
With 2 brass plugs & 1 extension tube.

**FILTRO BENZINA CON SUPPORTO**  
Con 2 tappi di bronzo e 1 tubo di estensione.

**FILTRE A ESSENCE AVEC SUPPORT**  
avec 2 bouchons en bronze et 1 tube d'extension

REF	MICRON				BRACKET
REC24950	25	1/4"	50 GPH	AL	AL
REC24952	10	1/4"	50 GPH	AL	AL





**FILTRO DECANTADOR DE COMBUSTIBLE COMPLETO CON VASO TRASPARENTE**



**COMPLET FUEL FILTER WITH TRANSPARENT BOWL**

**FILTRO DI DECANTAZIONE BENZINA COMPLETO CON VASCHETTA TRASPARENTE**

**FILTRE DÉCANTEUR ESSENCE AVEC BOL TRANSPARENT**

REF			BRACKET
RAC320R-RAC-01		AL	Plástico
RAC320R-RAC-03	RACS3213 LENS3213	Plástico Plastic Plastica Plastique	



REF				BRACKET
RECOFILALU			AL	Plástico
RECOFILTER	RECOBELEMENT LENS3213	150 l/h	Plástico Plastic Plastica Plastique	



TOHATSU

**FILTRO CON BOMBA CEBADORA**

**FILTER WITH PRIMMING PUMP**

**FILTRO CON POMPETA PER RIEMPIRE**

**FILTRE A ESSENCE AVEC POMPE D'AMORCAGE**

REF		MICRON			
RAC490R-RAC-01	RACS3227 LENS3227	10	340 l/h	3/8" NPTF	150 hp



**FILTRO DECANTADOR GASOLINA**

**COMPLETE FUEL FILTER**

**FILTRO DECANTATORE BENZINA**

**FILTRE DÉCANTEUR ESSENCE**

Filtro de combustible con braket.

Complete fuel filter with braket.

Filtro combustibile con supporto.

Filtre à carburant avec support.

REF		
RAC23299-10	RAC23289-10	130 HP (4 T/ Strokes)



RECAMBIOS MARINOS



REF	MICRON	Flow	HP
REC90794-46866	10	117 l/h	175 hp



LLAVE PARA FILTRO  
 FILTER KEY  
 CHIAVE DA FILTRO  
 CLÉ A FILTRE

REF
RECYS-225-15



REF	MICRON	Flow
PAF40-0701000EI	10	70 hp



REF	MICRON	Flow
PAF40-0701000EI	10	70 hp



new

RÁCORES      RACORS      RACCORDI      RACCORDS

REF	Thread	Size	Qty
GS31065	1/4" NPT	3/8" = 9.5 mm	1
GS31166	1/4" NPT	5/16" = 7.9 mm	2
GS31155	3/8" NPT	3/8" = 9.5 mm	2
GS31156	3/8" NPT	5/16" = 7.9 mm	2
GS31157	3/8" NPT	1/4" = 6.4 mm	2



REF	Thread	Size	Qty
GS31066	1/4" NPT	5/16" = 7.9 mm	2
GS31067	1/4" NPT	3/8" = 9.5 mm	2



GOLDENSHIP

LLAVES PARA FILTRO      FILTER KEY      CHIAVE DA FILTRO      CLÉ À FILTRE

REF  
 RACRK22628  
**RACOR**



REF  
 REC70720 65 - 110 mm  
**RECMAR**



FILTRO COMBUSTIBLE PARA MONTAJE EN LINEA      IN-LINE FUEL FILTER      FILTRO BENZINA PER MONTARE IN LINEA      FILTRE A ESSENCE EN LIGNE

REF	Flow	Size	Material	Qty
GS31001	50 l/h	6-8 mm	plástico / plastic / plastica / plastique	1
GS31002	150 l/h	8-10 mm	plástico / plastic / plastica / plastique	1



GOLDENSHIP

REF	OEM
PAF15-07080000	3AC-02230-0 3AD-02230-0 3B7-02230-0

MFS25  
 MFS25B  
 MFS30





new



REF			
GS30435	6, 8, 10 mm	metal + cristal metal + crystal metallo + cristallo métal + verre	1





**GOLDENSHIP**

REF	OEM
REC35-80365M	
	6 (1989, 1992-99) 8 (1989-99, 2001-02) F4 (1999-02) F9.9 (1989-95, 1997-99, 2001-02) FT 9.9 (1988-90)



REF	OEM			
REC40145	40145	1/4"	1/4"	plástico
REC40155	40155	5/16"	5/16"	plastic
REC40165	40165	3/8"	3/8"	plastica
REC40135	40135	5/16"	3/8"	plastique



REF	OEM
PAF4-05000300	346-02230-0 366-02230-0
	M5 MFS4 M9.8 MFS5 M9.9 MFS6 M15 MFS8 M18 MFS9.9 M40 MFS15 MFS20 MFS30



REF	OEM
REC16911-ZZ5-003	HZZ5-16911-003
	BFTW60A BFT60A





**new**

REF	OEM
REC16911-ZY3-010	HZY3-16911-010
	BFT75AK1 BFT90AK1 BFT115A BFT250A BFT225A BFT200A BFT150A





**new**

**ACEITE OIL OLIO HUILES**

REF			
REC2TU6	1 L	6	2 STROKES
REC2TU3	5 L	3	TC-W3
REC5W40U6	1 L	6	SAE 5W40
REC5W40U3	5 L	3	
REC10W30U6	1 L	6	SAE 10W30
REC10W30U3	5 L	3	
REC10W40U6	1 L	6	SAE 10W40
REC10W40U3	5 L	3	
REC25W40U3	5 L	3	SAE 25W40
REC80W90U3	5 L	3	SAE 80W90
REC80W90U6	1 L	6	



REF			
RM92-858026QB1U6	1 L	6	2 STROKES
RM92-858027QB1U3	3,8 L	3	
RM92-8M0086220U6	1 L	6	SAE 10W30
RM92-8M0086221U3	4 L	3	



**TOHATSU**

**RECAMBIOS MARINOS**

FILTRO DE ACEITE

OIL FILTER

FILTRO OLIO

FILTRE À HUILE

REF	OEM	4T STROKES
REC5GH-13440-00	3R3R76150M 3RO-07615-0 5GH-13440-00	✓

- MFS15
- MFS20
- MFS20
- MFS30
- MFS40
- MFS50
- MFS60



REF	OEM
REC15400-PLM-A01PE	HPLM-15400-A0 HPLM-15400-PE

- BFT75AK1
- BFT90AK1
- BFT225A
- BFT250A
- BFT200A
- BFT150A
- BFT115A



BOMBA DE COMBUSTIBLE

FUEL PUMP

POMPA BENZINA

POMPE À ESSENCE

MEMBRANAS Y JUNTAS

DIAPHRAGMS & GASKETS

MEMBRANA E GUARNIZIONI

MEMBRANES ET JOINTS

REF	OEM
REC8537312	350-04005-0

- M9.9D2
- M15D2
- M18E2
- M40D2
- M50D2

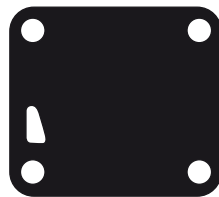

REF	OEM
REC27-8555691	3C8-04028-0

- M9.9D2
- M15D2
- M18E2
- M40D2
- M50D2

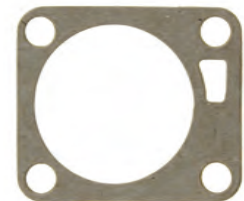

REF A	OEM
REC16275	369-03303-0

- M4C
- M5B
- M5BS
- M6B
- M8B
- M9.8B

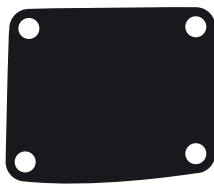

REF	OEM
REC27-16274	369-03302-0

- M4C
- M5B
- M5BS
- M6B
- M8B
- M9.8B

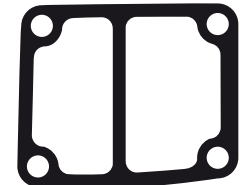

REF B	OEM
REC16325	369-03306-0

- M4C
- M5B
- M5BS
- M6B
- M8B
- M9.8B



REF	OEM
REC27-16326	369-03307-0

- M4C
- M5B
- M5BS
- M6B
- M8B
- M9.8B

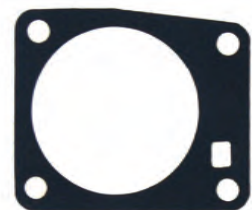

CARBURADOR

CARBURATOR

CARBURATORE

CARBURATEUR

CARBURADOR COMPLETO

FULL CARBURATOR

CARBURATORE COMPLETO

CARBURATEUR COMPLET

REF	OEM	4T STROKES
PAF8-05040000	3F5-03100-0 3V2-03100-2	✓

- MFS8
- MFS9.8HP



TOHATSU

RECAMBIOS MARINOS

**KITS CARBURADORES**

**CARBURETOR KITS**

**KIT CARBURATORI**

**KIT CARBURATEUR**

REF	OEM
REC6H3-W0093-02	346-87122-0

  
 45A2  
 50C  
 60C  
 70A2  
 M25C3  
 M30A4

REF	OEM
REC6G1-W0093-00	369-87122-1 3B2-87122-0

  
 5B  
 8B  
 9.8  
 M4

REF	OEM
REC6H4-W0093-03	3F3-87122-1

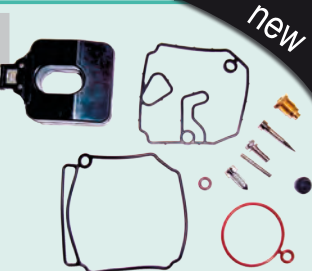
  
 M70

REF	OEM
REC66M-W0093-01	3V1-87122-0

  
 MFS8  
 MFS9

REF	OEM
REC6H1-W0093-01-00	346-87122-0

  
 M25  
 M30

REF	OEM
REC696-W0093-00	345-87122-4

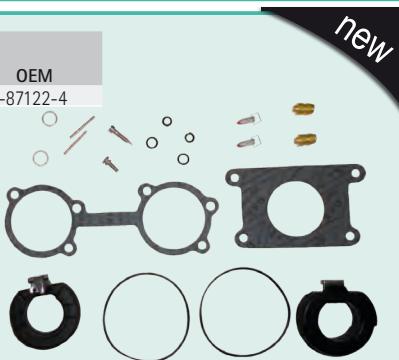
  
 C2  
 M40

REF	OEM
REC6A1-W0093-01	3F0-87122-2

  
 M2.5  
 M3.5

**KITS 2 CARBURADORES**

**KITS FOR 2 CARBURETORS**

**KIT 2 CARBURATORI**

**KIT 2 CARBURATEURS**

REF	OEM
REC84419M	345-87122-0

  
 M35C  
 M40C

REF	OEM
REC6L2-W0093-00	3C8-87122-2 3G2-87122-2

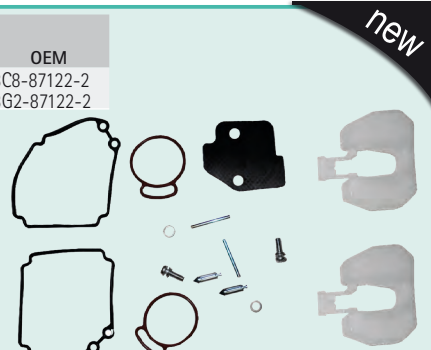
  
 M50  
 M15  
 M18

**BOYAS**

**FLOATS**

**GALLEGGIANTE**

**FLOTTEUR DE CARBURATEUR**

REF	OEM
REC162532	3C8-03125-0

  
 M9.9D2  
 M15D2  
 M18W2  
 M40D2

REF	OEM
REC16253	369-03231-0

  
 M4B  
 M5B  
 M5BS  
 M6B

# SISTEMA ELÉCTRICO ELECTRIC SYSTEM

# SISTEMA ELETTRICO SYSTEME ÉLECTRIQUE

## SENSORES

## SENSORS

## SENSORE

## CAPTEURS

### SENSOR PRESIÓN DE ACEITE

### OIL PRESURE SENSOR

### SENSORE PRESIONE OLIO

### CAPTEUR PRESION HUILE

REF	OEM
PAF15-07010100	3H6-07611-0
 MFS4 --> MFS40 HP	





### SENSOR DE OXÍGENO

### OXYGEN SENSOR

### SENSORE OSSIGENO

### SONDE À OXYGENE

REF	OEM
REC35668-ZY6-003	HZY6-35668-003
 BFT150A BFT115A	



### SENSOR POSICIÓN ÁRBOL DE LEVAS

### CAMSHAFT SENSOR

### SENSORE ALBERO A CAME

### CAPTEUR DE POSITION D'ARBRE A CAMES

REF	OEM
REC37510-PNB-003	HPNB-37510-003
 BFT150A BFT115A	

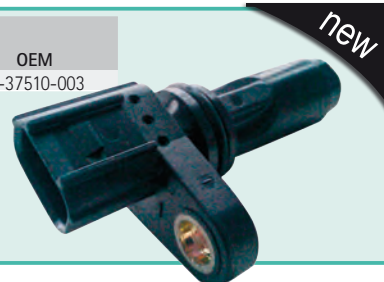

## BOBINAS

## COILS

## BOBINE

## BOBINES

### BOBINA

### COIL

### BOBINA

### BOBINE

REF	OEM
PAF8-05000300	3AA-06021-0
 MFS8 MFS9.8	



REF	OEM
REC3G3-06021-1	3G3-06021-1
 M9.9D2 M15D2 M18E2 M25C3 M30A4	



REF	OEM
REC369-06021-0	369-06021-0
 M4C M5B-BS	



TOHATSU

RECAMBIOS MARINOS

**BOBINA ENCENDIDO****STARTER COIL****BOBINA AVVIAMENTO****BOBINE DEMARREUR**

REF	OEM
PAF8-05000500	3V1-06040-0 3V1060400 3V1060400M

**BOBINA DE PULSACIÓN****PULSER COIL****BOBINA ACCENSIONE****BOBINE PULSEUR**

REF	OEM
PAF8-05000200	3V1-06071-0

**BOBINA DE IGNICIÓN****COIL IGNITION****BOBINA AVVIAMENTO****BOBINE D'ALLUMAGE**

REF	OEM
REC3A0-06040-1	3A0-06040-1



REF	OEM
REC3G2-06040-2	3G2-06040-2



REF	OEM
REC30580-ZV4-013	HZV4-30580-013

BFT75AKI  
BFT90AKI

*new*

**BOBINA DE CARGA****CHARGER COIL****BOBINA DI CARICA****BOBINE DE CHARGE**

REF	OEM
PAF8-05090000W	3V1-06023-0



# BUJÍAS

# SPARK

# CANDELE

# BOUGIES

2T STROKES	REF NGK	RO / OEM
M2.5/ M3.5/ 3/ 5B2	NGKBPR6HS-10	9701-1-1013
M4/ M5/ M6/ M8/ M9.8	NGKBPR7HS-10	9701-1-1014
M9.9/ M25/ M30/ 40D2	NGKBR7HS-10	9701-1-1015
MX40/ 50D3	NGKB8HS-10	9701-1-1006
MC4 through 9.8B, MX15/ 18E2	NGKBP7HS-10	9701-1-1010
M25/ 30H/ MX25	NGKB7HS-10	9701-1-1005
M50D2 Through 140A2	NGKBR8HS-10	9701-1-1110

4T STROKES	REF NGK	RO / OEM
MFS2.5 Through 30C	NGKDCPR6E	9701-1-1103
MD30/ MD40/ MD50/ MD75/ MD90	NGKIZFR6	9701-1-1111
MFS40/ 50A (Serial 046502AE +)	NGKIKR6G8	9701-1-1121
MD115A2 (TLDI)	NGKIZFR5J	9791-1-1109
BFT60A	NGKLMAR6C-9	HZZ3-31909-003



2T STROKES	REF CHAMPION
M3.5A / B	CHAL87YCC
M5B / BS	CHAL82YC
M6B	CHAL82YC
M8A / B 2Cil.	CHAL82YC
M9.9B2 / C 2Cil.	CHAL82C
B18C / D	CHAL86C
M12B	CHAL82C
M15A / B2 2Cil.	CHAL82C
M15C / D	CHAL82C
M16	CHAL82C
M18A / C2 2Cil.	CHAL82C
M18D / E	CHAL82C
M20	CHAL82C

2T STROKES	REF CHAMPION
B40A	CHAL86C
B30C	CHAL86C
M25C / C2 2Cil.	CHAL82C
M30A / A3 2Cil.	CHAL82C
M35A	CHAL82YC
M40C 2Cil.	CHAL82YC
M40D 3Cil.	CHAL82YC
M50C / D 3Cil.	CHAL78C
M70A / A2 3Cil.	CHAL78C
M70B	CHAL78C
M90A 3Cil.	CHAL78C
M115A 4Cil.	CHAL78C
M140A 4Cil.	CHAL78C

4T STROKES	REF CHAMPION
MFS4	OHV CHARA8HC
MFS5A	OHV CHARA8HC
MFS5C	OHV CHARA8HC
MFS9.9A	OHV CHARA8HC
MFS15A	OHV CHARA8HC



P 49  
REF REC004



REF CHAPROSU

# MOTORES DE ARRANQUE

# STARTERS

# MOTORINI AVVIAMENTO

# DÉMARREURS

## MOTORES DE ARRANQUE STARTERS

REF	OEM	⚡	☀️	2T STROKES	4T STROKES
PH130-0006	3C8-76010-1 3C8760101 3C8760101M	12V	0.6 kw	9 CCW	✓ ✓

- M40D2/B2
- M50D2/B2
- M70C
- MFS9.9B2-C
- MFS15B2-C
- MFS18B2
- MFS20C
- MFS25A-B
- MFS30B



## MOTORINI AVVIAMENTO DÉMARREURS

REF	OEM	⚡	☀️	2T STROKES	4T STROKES
PH130-0061	350-76010-0 3AA760100			✓	✓

- M15D2
- M18E2
- M8B
- M9.8B
- M9.9D2
- MFS8A2
- MFS9.8A2



REF	OEM	⚡	☀️	2T STROKES	4T STROKES
PH130-0048	353-76010-4		9	✓	

- MD70B
- MD90B
- MD115A-A2
- MD120A2
- MD140A2



REF	OEM	⚡	☀️	2T STROKES	4T STROKES
PH130-0080	346-76010-0, 346-76010-0A0 346-76010-0M			✓	

- M25C3
- M30A4
- M40C



TOHATSU

RECAMBIOS MARINOS

**new**

REF	OEM	⚡	☀️	2T	4T
				STROKES	STROKES
REC31200-ZY6-003	HZY6-31200-003				✓

 BFT150A  
 BFT115A



**new**

REF	OEM	⚡	☀️	2T	4T
				STROKES	STROKES
PH130-0070	HZY3-31200-003				✓

 BFT250A  
 BFT225A  
 BFT200A



**CDI Y CAJAS NEGRAS      CDI & POWER PACK      CDI E CENTRALINA      CDI ET BOITIER ELECTRONIQUE**

REF	OEM
REC3F0-06060-0	3F0-06060-0

 M2.5A2  
 B3.5A2-B2





REF	OEM
REC353-06260-0	353-06260-2 353-06260-0

 45A2  
 55B  
 60A  
 75A2





REF	OEM
REC3G2-06060-2	3G2-06060-2

 M9.9D2  
 B15D2  
 M18E2





REF	OEM
REC3A106-2602M	3A106-2402M 3A106-2601M 3A106-2602M

 25C2  
 30A3  
 40C



REF	OEM
PAF8-05000400	3AA-06060-00 3AA060600M

 MFS8  
 BFS9.8





# TRIM, TILT & POWER TRIM

## INSTALACIÓN ELÉCTRICA

## WIRING HARNESS

## INSTALLAZIONE ELETTRICA

## INSTALLATION ELECTRIQUE

### KIT CONVERSIÓN

Sustituye de 2 a 3 cables.

### CONVERSION KIT

Converts 3-wire Tilt and Trim motors to 2-Wire design

### KIT CONVERSIONE

Sustituisce da 2 a 3 cavi.

### KIT DE CONVERSION.

Passes un faisceau de 2 à 3 fils

REF

PH200-WH01



## TRIM COMPLETO

## COMPLETE TRIM ASSEMBLY

## MOTORINO TRIM COMPLETO

## MOTEUR DE TRIM

REF

OEM



PH200-T024

12V

3

2

✓

2T STROKES 4T STROKES

V4, V6 (1990-03)



## POWER TRIM COMPLETO

## COMPLETE POWER TRIM ASSEMBLY

## MOTORINO POWER TRIM COMPLETO

## POWER TRIM COMPLET

REF

2T STROKES 4T STROKES

REC18-6865

✓

✓

3 RAM  
115-225HP

SHOWA SYSTEM





# SISTEMA DE GOBIERNO STEERING SYSTEM

# SISTEMA DI GUIDA SYSTÈME DE COMMANDE

COMPONENTES	COMPONENTS	COMPONENTI	COMPOSANT				
CABLE DE ACELERADOR	THROTTLE CABLE	CAVO ACCELERATORE	CÂBLE D'ACCELERATEUR				
<table border="1"> <thead> <tr> <th>REF</th> <th>OEM</th> </tr> </thead> <tbody> <tr> <td>REC804898</td> <td>3B2-63600-1</td> </tr> </tbody> </table>  <p>M6B M8B M9.8B</p>	REF	OEM	REC804898	3B2-63600-1			
REF	OEM						
REC804898	3B2-63600-1						

# SISTEMA DE REFRIGERACIÓN COOLING SYSTEM

# SISTEMA DI RAFFREDDAMENTO SYSTÈME DE REFRROIDISSEMENT

TERMOSTATO	THERMOSTAT	TERMOSTATO	THERMOSTAT												
TERMOSTATO	THERMOSTAT	TERMOSTATO	THERMOSTAT												
<table border="1"> <thead> <tr> <th>REF</th> <th>OEM</th> <th>°C</th> </tr> </thead> <tbody> <tr> <td>REC855676002</td> <td>3R3-01030-0</td> <td>60°</td> </tr> </tbody> </table>  <p>MFS8 MFS30</p>	REF	OEM	°C	REC855676002	3R3-01030-0	60°		<table border="1"> <thead> <tr> <th>REF</th> <th>OEM</th> <th>°C</th> </tr> </thead> <tbody> <tr> <td>REC19300-ZV5-043</td> <td>HZV5-19300-043</td> <td></td> </tr> </tbody> </table>  <p>BFT115A BFT130A BFT150A</p>	REF	OEM	°C	REC19300-ZV5-043	HZV5-19300-043		
REF	OEM	°C													
REC855676002	3R3-01030-0	60°													
REF	OEM	°C													
REC19300-ZV5-043	HZV5-19300-043														
<table border="1"> <thead> <tr> <th>REF</th> <th>OEM</th> <th>°C</th> </tr> </thead> <tbody> <tr> <td>PAF15-07000031</td> <td>HZW9-19300-003</td> <td></td> </tr> </tbody> </table>  <p>BFT90AK1 BFT75AK1 BFT60A BFTW60A</p>	REF	OEM	°C	PAF15-07000031	HZW9-19300-003										
REF	OEM	°C													
PAF15-07000031	HZW9-19300-003														

**JUNTA TERMOSTATO**

**THERMOSTAT, GASKET BASE**

**GUARNIZIONE TERMOSTATO**

**JOINT DE THERMOSTAT**

REF	OEM
REC3T9-01032-0	3T9-01032-0

MD75C2  
MD70B / C2  
MD90D / C2



**JUNTAS TAPA, DE REFRIGERACIÓN**

**GASKETS EXHAUST INNER COVER**

**GUARNIZIONE COPERCHIO REFRIGERAZIONE**

**JOINT DE COUVERCLE DE REFRIGERANT**

REF	OEM
REC3F3-02305-1	3F3-02305-1

M60C  
M70C

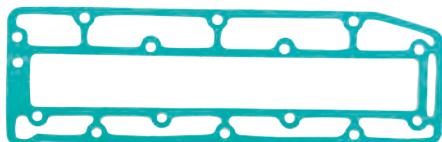

REF	OEM
REC3B7-02305-1	3B7-02305-1

MD70B  
MD90D

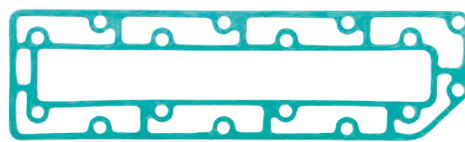

**IMPULSORES**

**IMPELLERS**

**GIRANTE**

**TURBINES**

**GUÍA DE IMPULSORES**

**IMPELLER GUIDE**

**GUIDA GIRANTE**

**GUIDE DES TURBINES**

2T STROKES	REF	OEM	CEF	A (mm)	B (mm)	C (mm)
2 / 2.5HP		369-65021-1	CEF500377	10,25	33,6	14,3
2.5A/3.5A/3.5B		309-65021-1	CEF500396	12	41	14
3.5 / 4 / 5 HP		369-65021-1	CEF500377	10,25	33,6	14,3
6 / 8 / 9.8 HP	REC3B2-65021-1	3B2-65021-1	CEF500344	12,1	40	18
9.9 / 15 / 18 HP		334-65021-0	CEF500383	13,96	40,7	23,35
25 / 30 / 35 HP	REC345-65021-0	345-65021-0	CEF500382	17,12	44,1	20,25
40 / 50 HP		345-65021-1	CEF500379	17,2	50,4	20,15
60 / 70 / 90 HP	REC3B7-65021-2	3B7-65021-2	CEF500388	20,15	67,4	35,1
115 / 120 / 140 HP		3C7-65021-1	CEF500388	20,15	-67,4	35,1

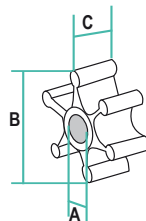

4T STROKES	REF	OEM	CEF	A (mm)	B (mm)	C (mm)
MFS4, 5, 6HP		369-65021-1	CEF500377	10,25	33,6	14,3
MFS8, 9.8 HP	REC3B2-65021-1	3B2-65021-1	CEF500344	12,1	40	18
MFS9.9, 15, 18HP		334-65021-0	CEF500383	13,96	40,7	23,35
20HP		334-65021-0	CEF500383	13,96	40,7	23,35
MFS25, 30HP	REC345-65021-0	345-65021-0	CEF500382	17,12	44,1	20,25
BFTW60A BT60A	REC19210-ZV5-003	HZV5-19210-003	CEF500338	17,20	55,90	20,20
BFT115A / 150A	REC19210-ZW1-B02	HZW1-19210-B04	CEF500337	23,35	87,80	31,00
BFT200A / 225A BFT250A	REC19210-ZY3-003	HZY3-19210-003	CEF500391	26	89,75	31,30



REC345-65021-0



REC3B2-65021-1

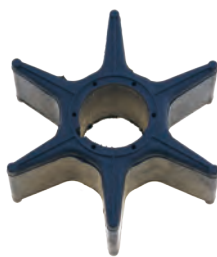

REC19210-ZY3-003



REC19210-ZV5-003



REC19210-ZW1-B02

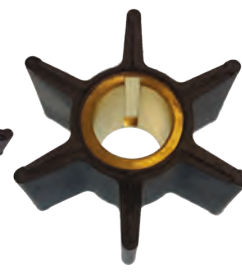

REC3B7-65021-2

**BOMBA DE AGUA**

**WATER PUMP**

**POMPA ACQUA**

**POMPE À EAU**

**JUNTA BASE DE BOMBA**

**WATER PUMP, GASKET BASE**

**GUARNIZIONE BASE POMPA**

**JOINT, BASE DE POMPE À EAU**

REF	OEM
PAF8-04000007	3B2-65025-0
 MD9.9D2 MD15D2 MD18E2	MFS9.9B2-C MFS15C MFS18B2 MFS20C



REF	OEM
REC16159	369-65025-0
 MFS4A2-B-C MFS5A2-B-C MFSA2-B-C	



**JUNTAS BOMBA**

**WATER PUMP GASKET**

**GUARNIZIONE POMPA**

**JOINTS DE POMPE**

REF	OEM
REC3F0-65029-0	3F0-65029-6
 M3.2B2 MFS2.5B MFS3.5B MFS2A	



**CASQUILLO INOX**

**INSERT CUP**

**GHIERA INOX**

**INSERT INOX**

REF	OEM
REC803751	350-65011-1
 M9.9D2 M15D2 M18E2 MFS9.9C, B2 MSF15C, B2 MSF20C MSF18B2	



REF	OEM
PAF8-04000010	3B2-65011-0
 M6 M8 M9.8B MFS8, A - A2 -A3 MFS9.8A - A2 -A3	



REF	OEM
REC16157	369-65011-0
 M4B M5B M5B5 MFS4, 5, 6 -A2	



**KITS DE REPARACIÓN BOMBA DE AGUA**

**WATER PUMP SERVICE KITS**

**KIT RICAMBI POMPA ACQUA**

**KIT POMPE À EAU**

**new**

REF	OEM
REC06192-ZY6-000	HZY6-06192-000
 BFT150 BFT115A	

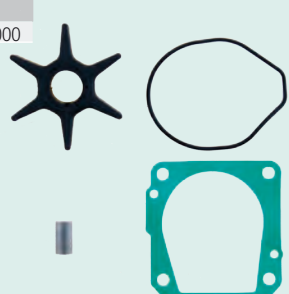

**new**

REF	OEM
REC06192-ZY3-000	HZY3-06192-000
 BFT200A BFT225A	

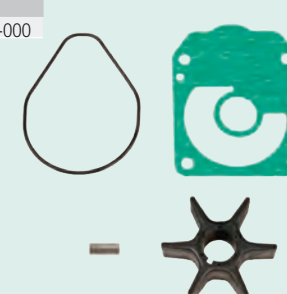



# ÁNODO

# ANODE

# ANODI

# ANODE

ZN	KG (KG)	AL	KG (KG)	OEM
CM3C760-2181	0,51	CM3C760-2181A	0,21	3C7760-2181

60, 70, 90, 120, 140 HP



ZN	KG (KG)	OEM
CM3B7-60218-0	0,51	3B7-60218-1

Serie MEGA

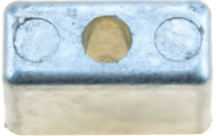

ZN	KG (KG)	AL	KG (KG)	OEM
CM5338602182A0	0,21	CM5338602182A0A	0,08	5338602182A0



ZN	KG (KG)	AL	KG (KG)	OEM
CM3H6-60218-000	0,03	CM3H6-60218-000A	0,01	3H6-60218-0



ZN	KG (KG)	OEM
CM3M2-60218-1	0,05	3M2-60218-0

40, 140 HP



ZN	KG (KG)	OEM
CM33860-2181	0,10	338-60218-2

2,5, 3,5, 5, 6, 8 HP  
15, 18, -S MAXI 25, 40  
CORSA



ZN	KG (KG)	AL	KG (KG)	OEM
CM3V1-60217-0	0,10	CM3V1-60217-0A	0,04	3V1602170



ZN	KG (KG)	OEM
CM348-60217-0M	0,12	348-60217-0

Serie MAXI CORSA  
25-40 HP



ZN	KG (KG)	OEM
CM3C8-60217-0	0,15	3C8-60217-1

Serie MEGA  
25-50 HP



ZN	KG (KG)	OEM
CM3B7-602170	0,15	3B7-60217-0

60, 70, 90, 120, 140 HP



TOHATSU

RECAMBIOS MARINOS

ÁNODO

ANODE

ANODI

ANODE

ZN	KG (KG)	OEM
TEN01254	0,51	3C7-60218-2

Serie 60 - 70 - 90 -  
120 - 140 - 150 HP



ZN	KG (KG)	OEM
TEN01253	0,150	3C8-60217-1

Serie MEGA 25 - 50  
HP



ZN	KG (KG)	OEM
TEN01256	0,040	3B7-60218-1

Serie MEGA



ZN	KG (KG)	OEM
TEN01252	0,120	348-60217-0

Serie MAXI CORSA 25  
- 40 HP



ZN	KG (KG)	OEM	Ø
TEN01250	0,010	338-60218-2	20 mm
TEN01251	0,020	369-60218-1	24 mm

Serie 2.5, 3.5, 5, 6, 8 HP  
15 - 18-S MAXI-25 - 40 CORSA



ZN	KG (KG)	OEM
TEN01255	0,320	3B7-60217-0

Serie 60 - 70 - 90 -  
120 - 140 HP



ZN	KG (KG)	OEM
TEN01257	0,050	3M2-60218-0

Serie 40 - 140 HP



ZN	KG (KG)	OEM
TEN01408	0,320	HZV4-12155-A00

BFTW60A  
BFT60A  
BFT200A  
BFT250A  
BFT225A



new

ZN	KG (KG)	OEM
TEN01258	0,020	5338602182A0

Serie 40 - 140 HP



ZN	KG (KG)	OEM
TEN01259	0,030	3H6-60218-0



ZN	KG (KG)	OEM
TEN01408/1	0,320	HZV5-12155-000

BFT60A  
BFT75AK1  
BFT90AK1  
BFT150A  
BFT200A  
BFT250A  
BFT225A  
BFT115A



new

ZN	KG (KG)	OEM
TEN01260	0,150	3B7-60217-0

Serie 140 HP



# PARTES DEL MOTOR ENGINE PARTS

# PARTI MOTORE PIECES MOTEUR

DESPIECE MOTOR  
DE 2 TIEMPOS

ENGINE PARTS  
2 STROKES

PARTI MOTORI  
2 TEMPI

PIECES DE MOTEURS  
2 TEMPS

2T M4C • M5B • M5BS  
STROKES

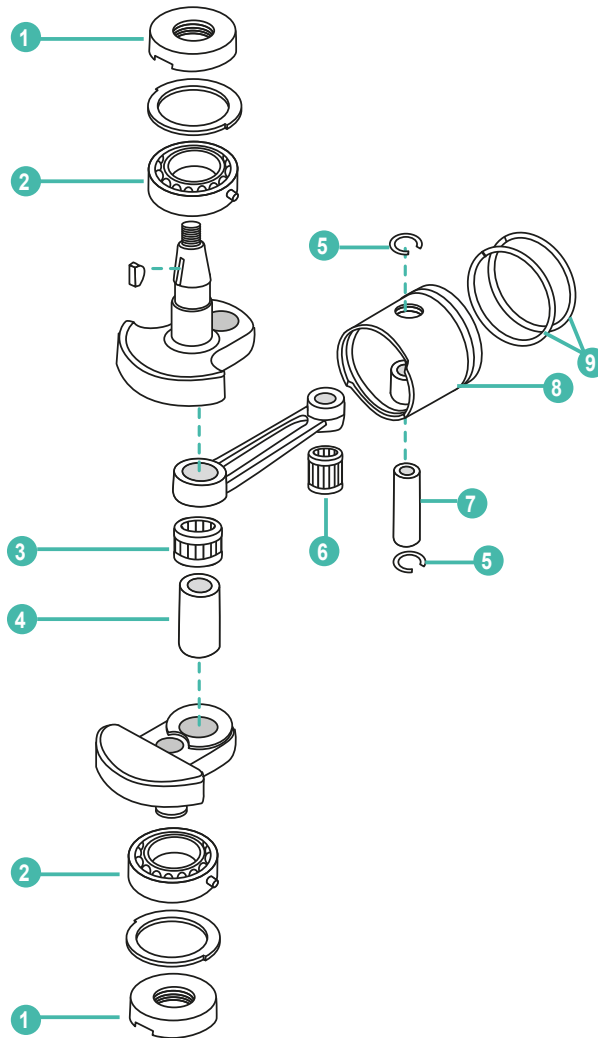

	REF	OEM					UN.
1	REC26-16051	369-00122-0	RETÉN ACEITE	OIL SEAL	PARALIO	JOINT SPI	2
2	REC30-16049	9603-3-6204	RODAMIENTO	BALL BEARING	CUSCINETTO	ROULEMENT	2
3	REC31-813048	369-00043-0	COJINETE DE AGUJA	NEEDLE BEARING	CUSCINETTO	ROULEMENT	1
4	REC813046002	369-00061-0	PIN	CRANK PIN	SPINOTTO	PIN	1
5	REC53-16057	350-00024-1	CLIP	CLIP	CLIP	CLIP	2
6	REC31-16052	350-00042-0	COJINETE DE AGUJA	NEEDLE BEARING	CUSCINETTO	ROULEMENT	1
7	REC41-16056	369-00021-0	PIN	PISTON PIN	SPINOTTO	AXE DE PISTON	1
8	REC779-9615T	369-00001-0	PISTÓN STD	PISTON STD	PISTONE STD	PISTON STD	1
9	REC8M0080357	351-00011-0	KIT SEGMENTOS	PISTON RING KIT	KIT FASCIA	KIT DE SEGMENTS	2

TOHATSU

RECAMBIOS  
MARINOS

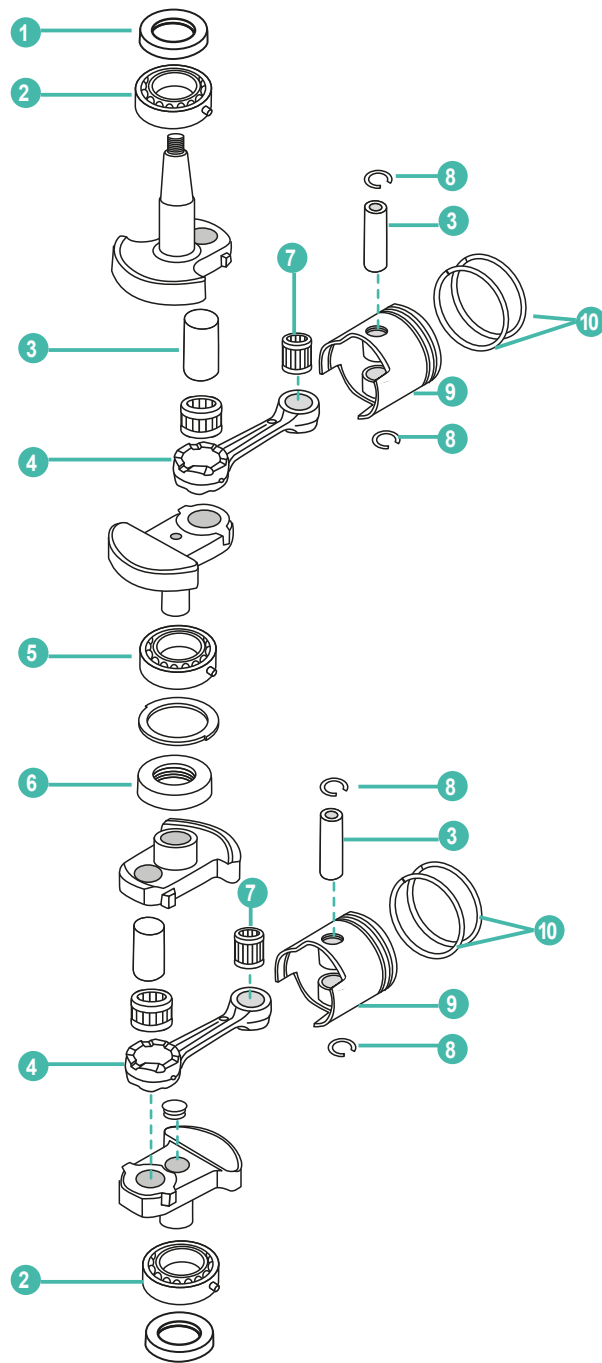

	REF	OEM					UN.
1	REC26-803514	101-00121-0	RETÉN ACEITE	OIL SEAL	PARALIO	JOINT SPI	1
2	REC30-16049	9603-3-6204	RODAMIENTO	BALL BEARING	CUSCINETTO	ROULEMENT	2
3	REC41-8036801	3B2-00021-0	PIN	PISTON PIN	SPINOTTO	AXE DE PISTON	2
4	REC629-8036741	3B2-00040-0	BIELA	CONNECTING ROD	BIELLA	BIELLE	2
5	REC30-16049	9603-3-6204	RODAMIENTO	BALL BEARING	CUSCINETTO	ROULEMENT	1
6	REC26-85370711	3B2-00051-0	RETÉN ACEITE	OIL SEAL	PARALIO	JOINT SPI	1
7	REC31-8036752	338-00042-0	COJINETE DE AGUJA	NEEDLE BEARING	CUSCINETTO	ROULEMENT	2
8	REC53-16057	350-00024-1	CLIP	CLIP	CLIP	CLIP	2
9	REC779-804886	3B2-00001-0	PISTÓN STD	PISTON STD	PISTONE STD	PISTON STD	2
10	REC39-803678A3	3B2-00011-0	KIT SEGMENTOS	PISTON RING KIT	KIT FASCIA	KIT DE SEGMENTS	4



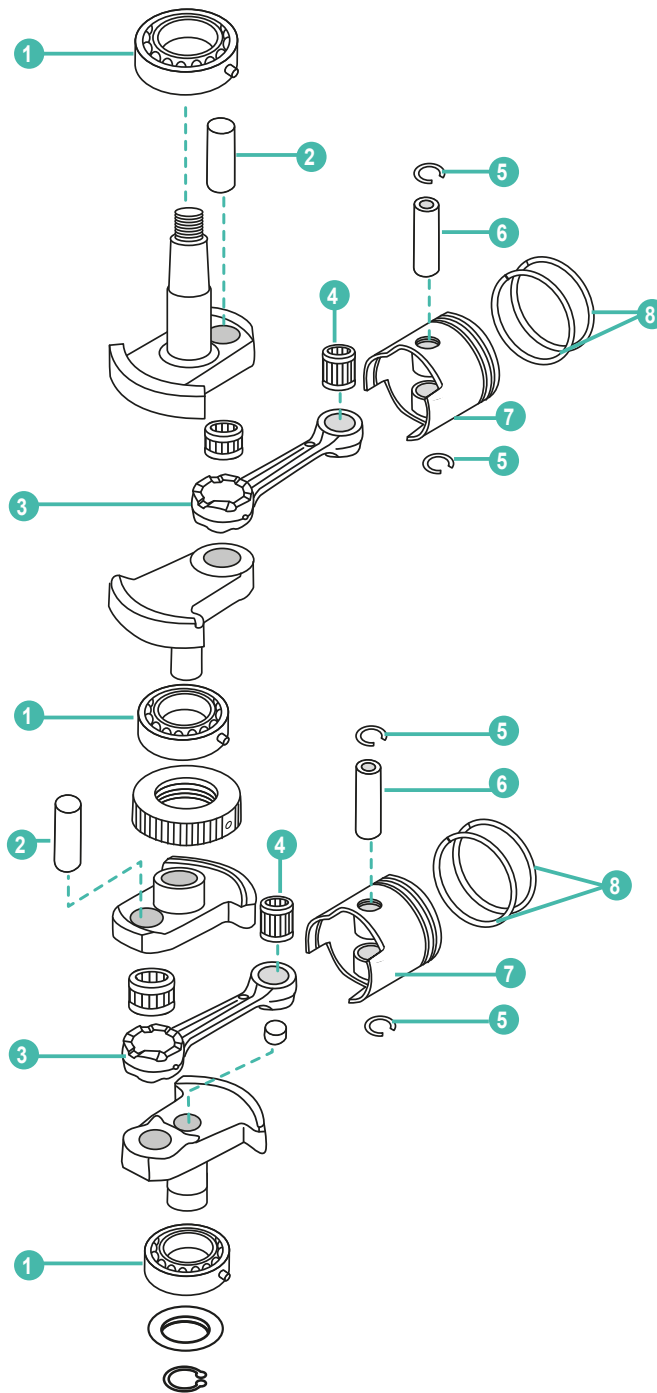

	REF	OEM				UN.	
1	REC30-160494	96603-3-6305	RODAMIENTO	BALL BEARING	CUSCINETTO	ROULEMENT	3
2	REC803673	350-00061-0	PIN	CRANK PIN	SPINOTTO	PIN	2
3	REC629-803674	350-00040-0	BIELA	CONNECTING ROD	BIELLA	BIELLE	2
4	REC31-16052	350-00042-0	COJINETE DE AGUJA	NEEDLE BEARING	CUSCINETTO	ROULEMENT	2
5	REC53-16057	350-00024-1	CLIP	CLIP	CLIP	CLIP	4
6	REC41-803680002	350-00021-0	PIN 18 HP	PISTON PIN 18 HP	SPINOTTO 18 HP	AXE DE PISTON 18 HP	2
	REC41-825713002	332-00021-0	PIN 9.9 / 15 HP	PISTON PIN 9.9 / 15 HP	SPINOTTO 9.9 / 15 HP	AXE DE PISTON 9.9 / 15 HP	2
7	REC779-803677T02	351-00001-1	PISTÓN STD, 9.9 / 15 HP	PISTON STD 9.9 / 15 HP	PISTONE STD 9.9 / 15 HP	PISTON STD 9.9 / 15 HP	1
	REC779-803677	350-00001-1	PISTÓN STD 18 HPP	PISTON STD HP	PISTONE STD 18 HP	PISTON STD 18 HP	1
8	REC39-803678A1	350-00011-0	KIT SEGMENTOS 18 HP	PISTON RING KIT 18 HP	KIT FASCIA 18 HP	KIT DE SEGMENTS 18 HP	2
	REC8M0080357	351-00011-0	KIT SEGMENTOS 9.9 / 15 HP	PISTON RING KIT 9.9 / 15 HP	KIT FASCIA 9.9 / 15 HP	KIT DE SEGMENTS 9.9 / 15 HP	2

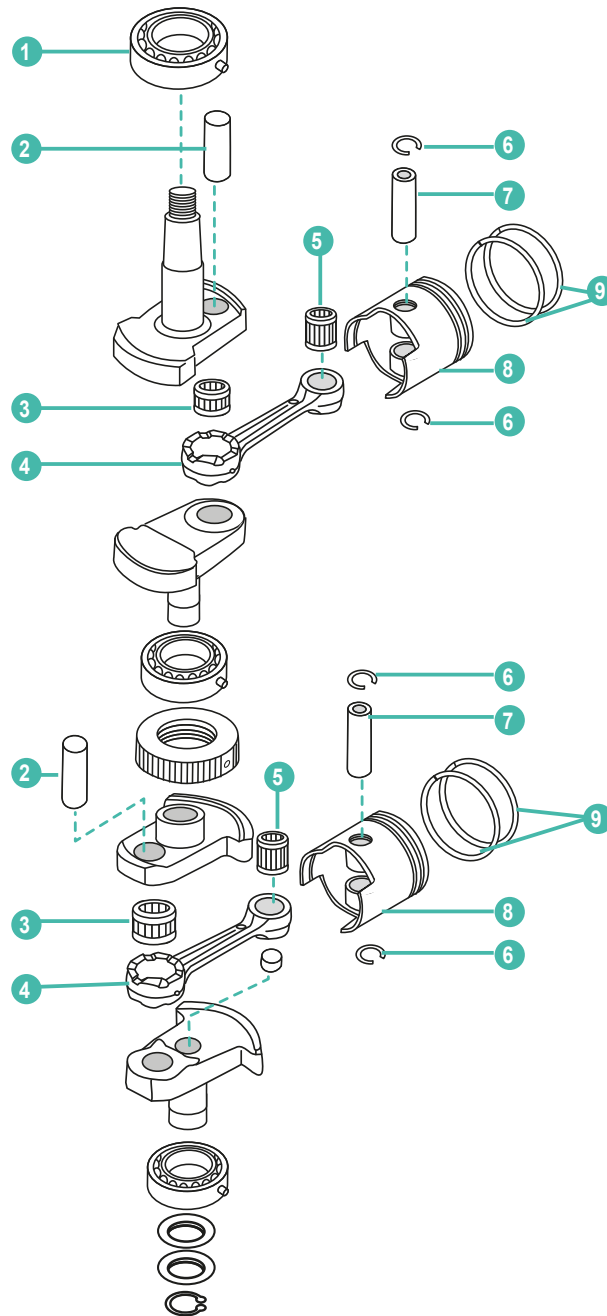

	REF	OEM					UN.
1	REC30-16049T01	345-00113-0	RODAMIENTO	BALL BEARING	CUSCINETTO	ROULEMENT	1
2	REC8130461	334-00061-0	PIN	CRANK PIN	SPINOTTO	PIN	2
3	REC31-8130482	356-00043-0	COJINETE DE AGUJA	NEEDLE BEARING	CUSCINETTO	ROULEMENT	2
4	REC629-813047T01	336-00040-1	BIELA	CONNECTING ROD	BIELLA	BIELLE	2
5	REC345-00042-0	345-00042-0	COJINETE DE AGUJA	NEEDLE BEARING	CUSCINETTO	ROULEMENT	1
6	REC53-16057	334-00024-1	CLIP	CLIP	CLIP	CLIP	4
7	REC41-803680003	3C8-00021-0	PIN	PISTON PIN	SPINOTTO	AXE DE PISTON	2
8	REC779-879194T01	346-00001-1	PISTÓN STD	PISTON STD	PISTONE STD	PISTON STD	2
9	REC39-16054A5	346-00011-0	KIT SEGMENTOS	PISTON RING KIT	KIT FASCIA	KIT DE SEGMENTS	4

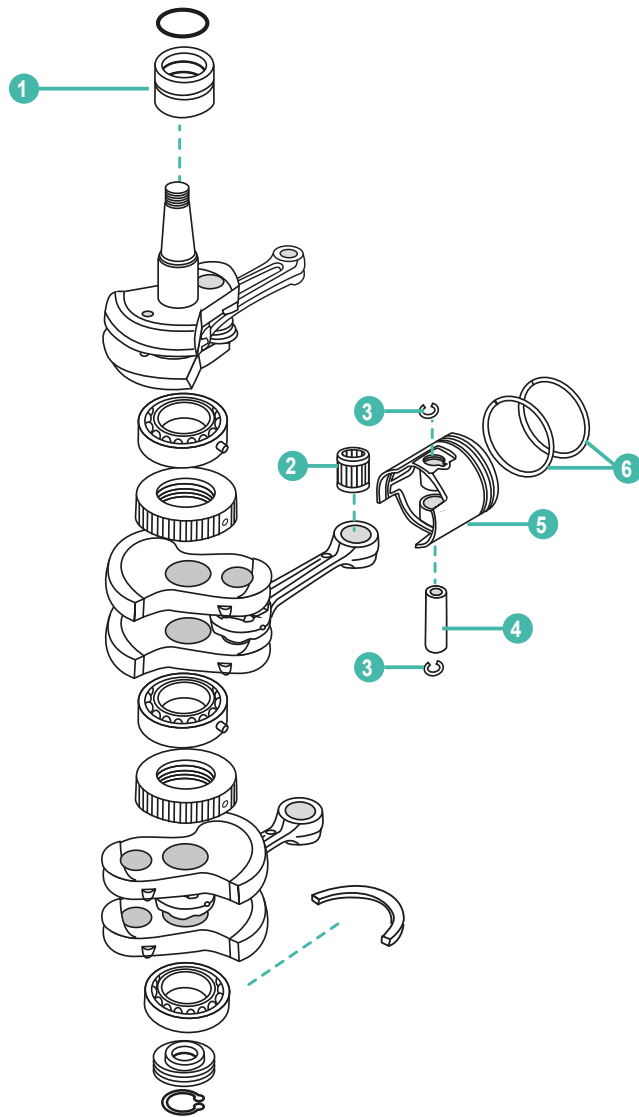

	REF	OEM					UN.
1	REC31-855553	3C8-00113-0	RODAMIENTO SUP.	MAIN BEARING UPPER	CUSCINETTO SUPERIORE	ROULEMENT SUPERIEUR	1
2	REC345-00042-0	345-00042-0	COJINETE DE AGUJA	NEEDLE BEARING	CUSCINETTO	ROULEMENT	3
3	REC53-16057	334-00024-1	CLIP	CLIP	CLIP	CLIP	6
4	REC41-16056	3C8-00021-0	PIN	PISTON PIN	SPINOTTO	AXE DE PISTON	3
5	REC779-9615T	3C8-00001-3	PISTÓN STD	PISTON STD	PISTONE STD	PISTON STD	3
6	REC8M0080349	346-00011-0	KIT SEGMENTOS	PISTON RING KIT	KIT FASCIA	KIT DE SEGMENTS	6

4T MFS8 • MFS9.9  
STROKES

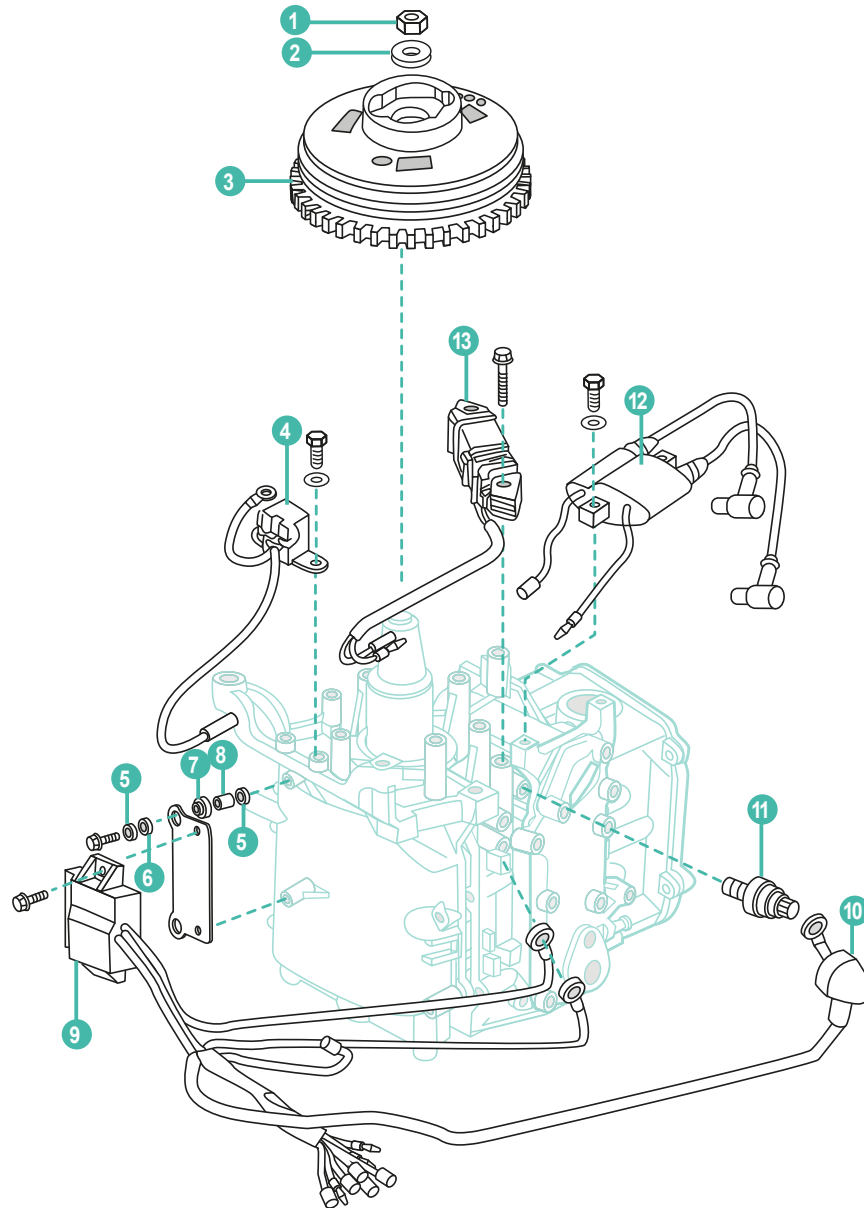

	REF	OEM				
1	PAF8-05000024	369-00132-0	TUERCA	NUT, FLYWHEEL	DADO	ÉCROIU
2	PAT15-04000011	940121-1200	ARANDELA	WASHER, FLYWHEEL NUT	RONDELLA	RONDELLE
3	PAF8-050000600	3AA-06091-0	EJE DE VOLANTE	FLYWHEEL ASSY	ASSE VOLANTE	VOLANT MOTEUR
4	PAF8-050000200	3V1-06071-0	BOBINA PULSACIÓN	COIL PULSER	BOBINE ACCENSIONE	BOBINE PULSEUR
5	PAF8-050000021	3R0-66308-0	ARANDELA	WASHER	RONDELLA	RONDELLE
6	PAF8-050000007	3B7-06305-0	AMORTIGUADOR (A)	ABSORBER (A) CDI	CUSCINO (A)	SILENT BLOC (A)
7	PAF8-050000011	3T5-06920-0	AMORTIGUADOR (B)	ABSORBER (B) CDI	CUSCINO (B)	SILENT BLOC (B)
8	PAF8-050000006	3A0-76079-0	MANGUERA	TUBE	TUBO	DURITE
9	PAF8-050000400	3AA-06060-0	CDI	CDI	CDI	CDI
10	PAF15-07010101	3H6-07612-0	AISLANTE	JACKET INSULATION	ISOLANTE	ISOLANT
11	PAF15-07010100	3H6-07611-0	SENSOR PRESIÓN ACEITE	OIL PRESSURE SENSOR	SENSORE PRESSIONE OLIO	SONDE DE PRESSION D'HUILE
12	PAF8-050000500	3V1-06040-0	BOBINA ENCENDIDO	STARTER COIL ASSY	BOBINA AVVIAMENTO	BOBINE DÉMARREUR
13	PAF8-050000300	3AA-06021-0	BOBINA	COIL	BOBINE	COIL

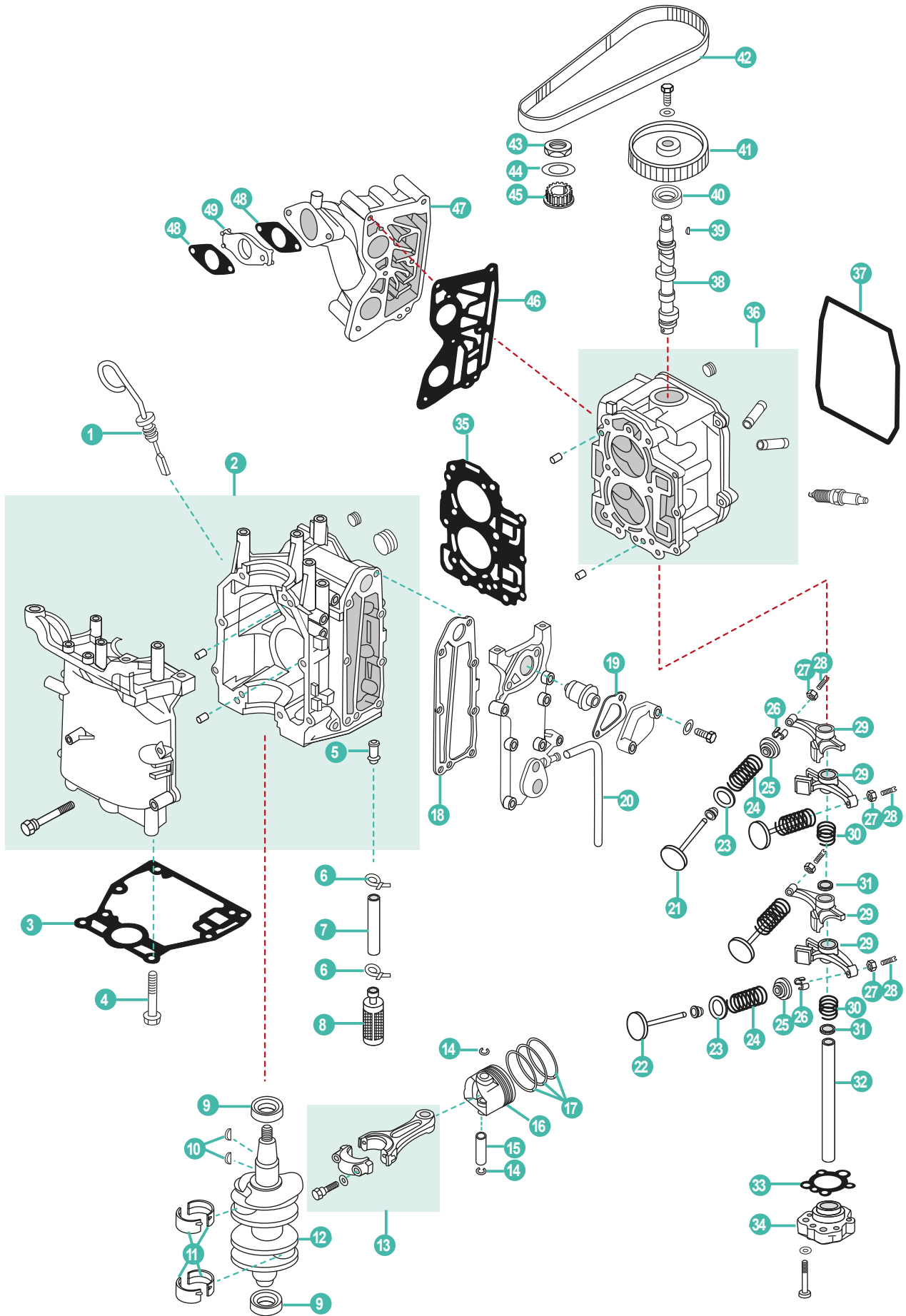

	REF	OEM				
1	PAF8-0000200	3V1-07421-0	MEDIDOR NIVEL ACEITE	OIL LEVEL GAUGE	MISURATORE LIVELLO OLIO	JAUGE D'HUILE
2	PAF8-05010000	3V1B01100-0	BLOQUE COMPLETO	CRANKCASSE ASSY	BLOCCO MOTORE	MOTEUR COMPLET
3	PAF8-00000004	3V1-01303-0	JUNTA BASE MOTOR	GASKET, ENGINE BASEMENT	GUARNIZIONE BASE MOTORE	JOINT, BASE DE MOTEUR
4	PAF8-00000003	3R3-61017-0	TORNILLO M8x35	BOLT M8x35	VITE M8x35	VIS M8x35
5	PAF8-05010002	3H8-02093-0	RACORD	NIPPLE	RACCORDO	RACORD
6	PAF8-05000025	369-84398-0	CLIP	HOOP	CLIP	CLIP
7	PAF8-05000017	98AH10-0120	MANGUERA	HOSE	TUBO	DURITE
8	PAF8-05000800	3V1-07410-0	FILTRO ACEITE	OIL STRAINER	FILTRO OLIO	FILTRE A HUILE
9	PAF8-05010012	3V1-00121-0	RETÉN ACEITE	OIL SEAL	PARAOLIO	JOINT SPI
10	PAF4-04000019	3T5-10131-0	CHAVETA	KEY	CHIAVETTA	CLAVETTE
11	PAF8-05010009	3V1-07407-0	COJINETE	BUSH	BRONZINA	ROULEMENT
12	PAF8-05020001	3V1-00030-1	CIGÜEÑAL	CRANK	ALBERO MOTORE	VILEBREQUIN
13	PAF8-05020200	3V1-00040-0	BIELA	CONNENCTING ROD	BIELLA	BIELLE
14	PAF15-07020005	350-00024-1	CLIP	CIRCLIP	CLIP	CLIP
15	PAF8-05020105	332-00021-0	PIN	PIN, PISTON	SPINNOTO	AXE DE PISTON
16	PAF8-05020101	3V1-00001-0	PISTON	PISTON	PISTONE	PISTON
17	REC39-8M0055809	3V1-00011-0	KIT SEGMENTOS	PISTON RING KIT	KIT FASCIA	KIT DE SEGMENTS
18	PAF8-05010004	3V1-02305-0	JUNTA ESCAPE	GASKET, EXHAUST COVER	GUARNIZIONE SCARICCO	JOINT D'ÉCHAPPEMENT
19	PAF8-05010005	346-01032-0	JUNTA TERMOSTATO	GASKET, THERMOSTAT COVER	GUARNIZIONE TERMOSTATO	JOINT DE THERMOSTAT
20	PAF8-05000024	98AB-5-0330	TUBO	WATER PIPE	TUBO	DURITE
21	PAF8-05030001	3V1-07201-0	VÁLVULA ADMISIÓN	VALVE INTAKE	VALVOLA ASPIRAZIONE	SOUPAPE D'ADMISSION
22	PAF8-05030002	3V1-07202-0	VÁLVULA ESCAPE	VALVE EXHAUST	VALVOLA SCARICO	SOUPAPE D'ÉCHAPPEMENT
23	PAF8-05030004	3V1-07205-0	ASIENTO MUELLE	SEAL, VALVE SPRING	SIGILLO MOLLA	SIEGE RESSORT DE SOUPAPE
24	PAF8-05030005	3AA-07203-0	MUELLE VÁLVULA	SPRING VALVE	VALVOLA MOLLA	RESSORT DE SOUPAPE
25	PAF8-05030006	3V1-07221-0	RETEN RESORTE	RETAINER, VALVE SPRINGER	VALVOLA DI RITEGNO	JOINT DE RESSORT
26	PAF8-05030007	3H6-07223-0	SEGURO DE VÁLVULA	CLAMP, VALVE	BLOCCAGGIO DI VALVOLA	CLAVETTE DE SOUPAPE
27	PAF15-07040304	3H8-07237-0	TUERCA	LOCK NUT	GHIERA	ÉCROU
28	PAF15-07040303	3R0-07238-0	TORNILLO AJUSTE	SCREW, VALVE ADJUSTING	VITE	VIS
29	PAF8-05030200	3V1-07235-0	BALANCÍN	ROCKER	BILANCERE	CULBUTEUR
30	PAF8-05030009	3AA-07225-0	MUELLE	SPRING ROCKER	MOLLA	RESSORT
31	PAF8-05030015	3R3-07227-0	ARANDELA	BUSHER, ROCKER SPRING	RONDELLA	RONDELLE
32	PAF8-005030010	3H8-07226-0	EJE	SHAFT ROCKER	ASSE	AXE DE CULBUTEUR
33	PAF8-05030012	3V1-07653-0	JUNTA BOMBA ACEITE	OIL PUMP GASKET	GUARNIZIONE POMPA OLIO	JOINT POMPE
34	PAF8-05030300	3V1-07600-0	BOMBA ACEITE	OIL PUMP	POMPA OLIO	POMPE À HUILE
35	PAF8-05000100	3V1-02305-0	JUNTA CULATA	CYLINDER HEAD GASKET	GUARNIZIONE TESTATA	JOINT DE CULASSE
36	PAF8-05030100	3V1B01001-0	CULATA	CYLINDER HEAD ASSY	TESTATA	CULASSE
37	PAF8-05000002	3V1-01024-0	JUNTA TAPA CULATA	CYLINDER HEAD COVER GASKET	GUARNIZIONE COPERCHIO TESTATA	JOINT COUVERCLE
38	PAF8-05030008	3V1-07010-0	ÁRBOL DE LEVAS	CRAMSHAFT	ALBERO MOTORE	ARBRE À CAMES
39	PAT3.6-04000006	309-00131-0	CHAVETA	KEY	CHIAVETTA	CLAVETTE
40	PAF8-05030011	3H8-07025-0	RETÉN ACEITE	OIL SEAL 18x35x7.8 mm	PARAOLIO	JOINT SPI
41	PAF8-05030400	3H8-10062-2	POLEA	DRIVER PULLEY	PULEGGIA	POULIE
42	PAF8-05000004	3V1-10045-0	CORREA	TIMING BELT	CINGHIA DI DISTRIBUZIONE	COURROIR DISTRIBUTION
43	PAF8-05010016	3V1-10068-0	TUERCA	NUT	DADO	ÉCROU
44	PAF8-05010015	3V1-10063-0	ARANDELA	BELT GUIDER	RONDELLA	RONDELLE
45	PAF8-05010014	3V1-10060-0	POLEA	DRIVER PULLEY	PULEGGIA	POULIE
46	PAF8-05000009	3V1-02104-0	JUNTA COLECTOR	GASKET MANIFOLD	GUARNIZIONE COLLETTORE	JOINT DE COLLECTEUR
47	PAF8-05000008	3V1-02010-1	COLECTOR ADMISIÓN	INTAKE MANIFOLD	COLLETTORE ASPIRAZIONE	COLLECTEUR D'ADMISSION
48	PAF15-07000017	3V1-02011-0	JUNTA CARBURADOR	GASKET CARBURETOR	GUARNIZIONE CARBURATORE	JOINT CARBURATEUR
49	PAF15-07000018	3V1-03952-0	SEPARADOR, CARBURADOR	INSULATOR, CARBURETOR	ISOLANTE, CARBURATORE	ISOLANT CARBURATEUR

4T MFS8 • MFS9.9  
STROKES

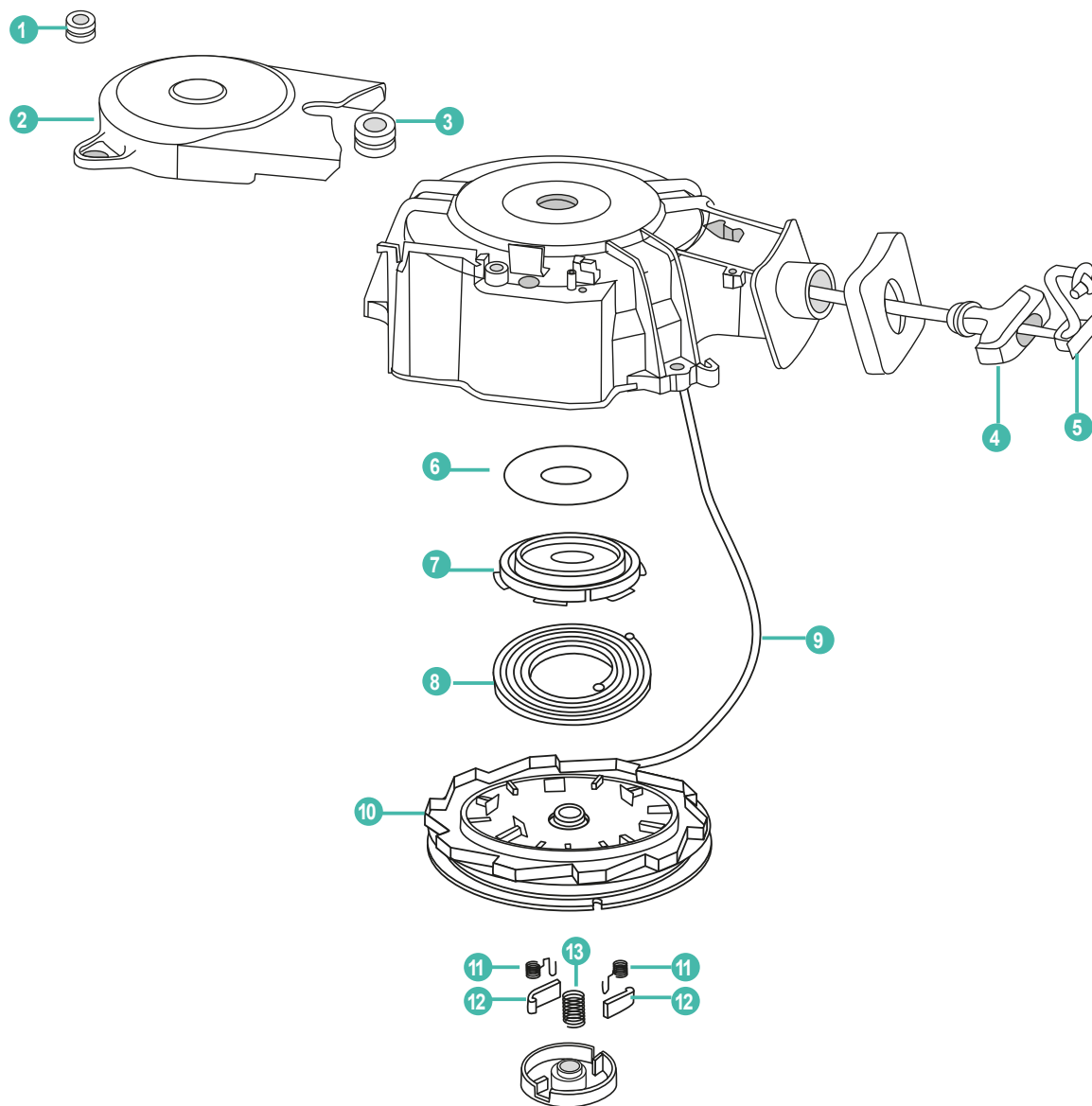

	REF	OEM			
1	PAF8-05000003	172-36008-0	RETÉN	RUBBER GROMMET A	TENUTA
2	PAF8-05000012	3V1-06308-0	TAPA	COVER, STRAP	COPERCHIO
3	PAF8-05000013	3V1-06302-0	RETÉN	RUBBER GROMMET B	TENUTA
4	PAF4-04130101	3AA-05019-0	TIRADOR	HANDLE, STARTER	MANIGLIA AVVIAMENTO
5	PAF4-04130102	3R1-05131-0	TAPA	COVER, HANDLE	COPERCHIO
6	PAF8-05050002	3V1-05259-0	ARANDELA	WASHER, THRUST	RONDELLA
7	PAF8-05050003	3R1-05125-0	MUELLE	SPRING CASE	MOLLA
8	PAF8-05050004	3AA-05004-0	MUELLE	VOLUTE SPRING	MOLLA
9	PAF8-05050018	3AA-05013-0	CUERDA	START LINE	CORDA DI AVVIAMENTO
10	PAF8-05050005	3V1-05104-1	VOLANTE	WHELL, START-UP	VOLANTE
11	PAF8-05050007	3R1-05012-0	MUELLE	SPRING, TENSIÓN	MOLLA
12	PAF8-05050006	3R1-05003-1	UÑA PLÁSTICA	PAWL, DRIVE	NOTTOLINO
13	PAF8-05050009	3R1-05007-0	MUELLE	SPRING PLATE	MOLLA
					JOINT
					COUVERCLE
					JOINT
					POIGNEE DE LANCEUR
					COUVERCLE
					RONDELLE
					RESSORT
					RESSORT
					CORDA DE LANCEUR
					VOLANT
					RESSORT
					RESSORT
					CLIQUET
					RESSORT

**JUNTAS DE MOTOR  
4 TIEMPOS**

**ENGINE GASKET  
4 STROKES**

**GUARNIZIONI  
MOTORE 4 TEMPI**

**JOINTS DE MOTEUR  
4 TEMPS**

**JUNTAS DE CULATA**

**CYLINDER HEAD GASKET**

**GUARNIZIONE DE TESTATA**

**JOINT DE CULASSE**

REF	OEM
REC309-01005-2	309-01005-2

 M2.5  
 M2.5A  
 M2.5A2  
 M3.5A  
 M3.5A2



REF	OEM
REC346-01005-0	346-01005-0

 M25C3  
 M30A4



REF	OEM
REC3B2-01005-0	3B2-01005-0

 M6B  
 M8B  
 M9.8B



REF	OEM
REC3C8-01005-4	3C8-01005-4

 M40D2  
 M50D2



REF	OEM
REC351-01005-0	351-01005-0

 M9.9D  
 M15D  
 M9.9D2  
 M15D2



REF	OEM
REC3F3-01005-0	3F3-01005-0

 M60C  
 M70C



REF	OEM
REC350-01005-0	350-01005-0

 M18E2



REF	OEM
REC3T9-01005-0	3T9-01005-0

 MD70  
 MD90

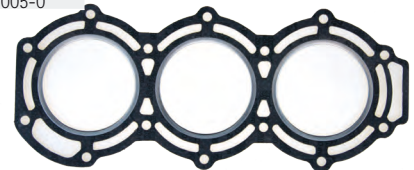

**KITS  
JUNTAS DE CULATA**

**CYLINDER HEAD GASKET  
KIT**

**KIT  
GUARNIZIONE TESTATA**

**KITS  
JOINTS MOTEUR**

REF	OEM
REC3T5-87121-6	3T5-87121-6

 MD40B2  
 MD50B2

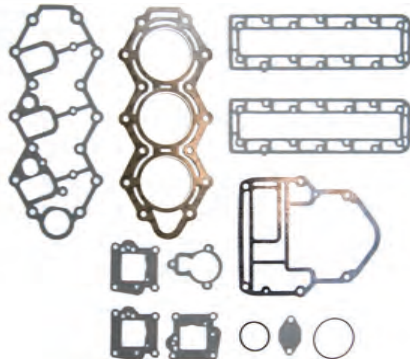

REF	OEM
REC3B7-87121-1	3B7-87121-7

 M80A  
 M90A

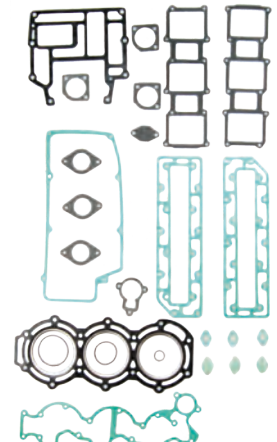

**JUNTAS DE CULATÍN**

**GASKET, HEAD COVER**

**GUARNIZIONE COPERCHIO  
TESTA**

**JOINTS DE COUVRE  
CULASSE**

REF	OEM
REC3C8-01024-0	3C8-01024-0

 M40D2  
 M50D2



REF	OEM
REC3F3-01024-0	3F3-01024-0

 M60C  
 M70C





**JUNTAS BASE DE MOTOR**

**CYLINDER GASKET**

**GUARNIZIONE  
BASE MOTORE**

**JOINTS DE TÊTE MOTRICE**

REF	OEM
REC350-01303-0	350-01303-0

- M9.9D2
- M15D2
- M18E2

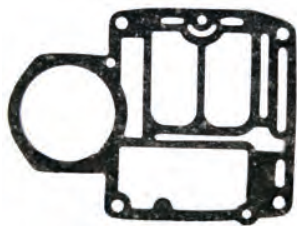

REF	OEM
REC3C8-01303-4	3C8-01303-4

- MD40B
- MD50B

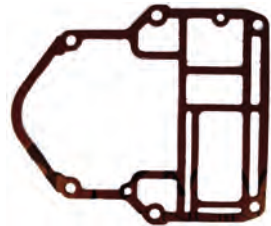

REF	OEM
REC350-61012-1	350-61012-1

- M9.9D2
- M15D2
- M18E2

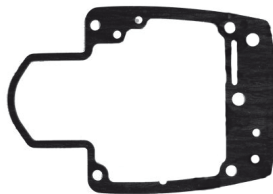

REF	OEM
REC3F3-01303-1	3F3-01303-1

- M60C
- M70C



REF	OEM
REC346-01303-0	350-01303-0

- M25C3
- M30A4

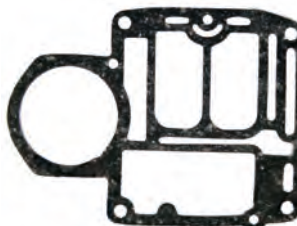

REF	OEM
REC3B2-01303-0	3B2-01303-0

- M6B
- M8B
- M9.8B

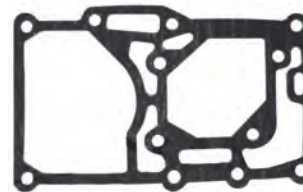

**RETENES DE ACEITE OIL SEALS**

**PARAOLIO**

**JOINT SPI**

**RETÉN DE ACEITE**

**OIL SEAL**

**PARAOLIO**

**JOINT SPI**

REF	OEM	18 x 28 x 6 mm
REC26-8537072	346-01215-0	

- M25C3
- M30A4
- MFS25A-B
- MFS30A-B
- MFS40A
- MFS50A



REF	OEM	18 x 28 x 8 mm
REC26-161301	346-60111-0	

- M25C3
- M30A4
- MFS30A - B
- MFS25A - B



REF	OEM	17 x 30 x 9 mm
REC26-161622	346-65013-0	

- M15D2
- M18E2
- M25C3
- M30A4
- M9.9D2
- MFS20C
- MFS18B2
- MFS15C-B2
- MFS30B-A
- MFS25A-B
- MFS20C
- MFS9.9B2-C



REF	OEM	25 x 45 x 8 mm
REC26-803667	350-00121-0	

- M9.9D2
- M15D2
- M18E2

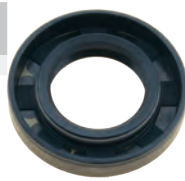

REF	OEM	25 x 69 x 9,5 mm
REC8M0065585	350-01215-5	

- M9.9D2
- M15D2
- M18E2

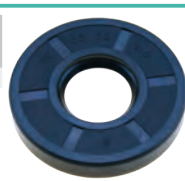

REF	OEM	10 x 62 x 7 mm
REC26-16703	369-01215-0	

- M4C
- M5B
- M5BS
- MFS4A-B / 5A-B-C / 6A-B-C



REF	OEM	10 x 24 x 8 mm
REC26-16162	369-60223-0	

- M4C
- M5B
- M5BS
- MFS4A-B / 5A-B-C / 6A-B-C



# CIGÜEÑAL

# CRANKSHAFT

# ALBERO MOTORE

# VILEBREQUIN

## RODAMIENTOS DE CIGÜEÑAL

## CRANKSHAFT BEARINGS

## CUSCINETTI ALBERO MOTORE ROULEMENTS VILEBREQUIN

SUPERIOR | UPPER | SUPERIORE | SUPERIEUR

REF	OEM
REC30-898101936	9643-3-6004

M2.5A  
M3.5A-B



INFERIOR | UNDER | INFERIORE | INFERIEUR

REF	OEM
REC30-95307	9643-3-6202

M2.5A  
M3.5A-B



# PISTONES

# PISTONS

# PISTONI

# PISTONS

## KITS DE PISTONES

## PISTON KITS

## KIT PISTONE

## KIT PISTON

	STD	OEM
	REC779-803677	350-00001-0
	REC8M0080357	351-00011-0
	REC629-803674	350-00040-0
	REC41-825713002	332-00021-0
	REC53-16057	350-00024-1
	REC31-16052	350-00042-0

M9.9D2  
M15D2 (2 Cyl)



	STD	OEM
	REC779-9615T	369-00001-0
	REC8M0080357	351-00011-0
	REC41-16056	369-00021-0
	REC53-16057	350-00024-1
	REC31-16052	350-00042-0

M4C  
M5B  
M5BS (1 Cyl)



	STD	OEM
	REC779-803677T02	351-00001-1
	REC629-803674	350-00040-0
	REC41-803680002	350-00021-0
	REC53-16057	350-00024-1
	REC31-16052	350-00042-0

M18E2 (2 Cyl)



	STD	OEM
	REC779-804886	3B2-00001-0
	REC39-803678A3	3B2-00011-0
	REC629-8036741	3B2-00040-0
	REC41-8036801	3B2-00021-0
	REC53-16057	350-00024-1
	REC31-8036752	338-00042-0

M6B  
M8B  
M9.8B (2 Cyl)



	STD	
	REF	OEM
	REC779-879194T01	346-00001-1
	REC39-16054A5	346-00011-0
	REC629-813047T01	336-00040-1
	REC41-803680003	3C8-00021-0
	REC53-16057	350-00024-1
	REC345-00042-0	345-00042-0

 M25C3  
M30A4 (2 Cyl)



	STD	
	REF	OEM
	REC779-96152	3C8-00001-3
	REC8M0080349	356-00011-0 346-00011-0
	REC629-8036741	3B2-00040-0
	REC41-803680003	3C8-00021-0
	REC53-16057	334-00024-1
	REC345-00042-0	345-00042-0

 M40D2  
M50D2 (3 Cyl)



	STD	
	REF	OEM
	PAF8-05020101	3V1-00001-0
	PAF8-05020200	3V1-00040-0
	PAF8-05020105	332-00024-0
	PAF15-07020005	350-00024-1

 MFS8  
MFS9.8A-A2-A3 (2 Cyl)





**P 51**

REF  
CRA904633  
CRA946331



REF  
SSP4213

**P 51**

# SISTEMA DE ESCAPE Y ADMISIÓN EXHAUST & INTAKE SYSTEM

# SISTEMA DI SCARICO E ASPIRAZIONE SYSTÈME D'ÉCHAPPEMENT ET D'ADMISSION

SISTEMA DE ESCAPE	EXHAUST SYSTEM	SISTEMA SCARICO	SYSTÈME D'ÉCHAPPEMENT
-------------------	----------------	-----------------	-----------------------

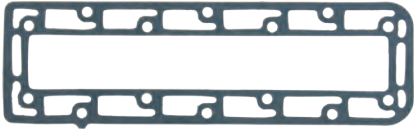

JUNTAS DE ESCAPE	GASKET, EXHAUST	GUARNIZIONE SCARICO	JOINTS D'ÉCHAPPEMENT
------------------	-----------------	---------------------	----------------------

<table border="1"> <tr> <th>REF</th> <th>OEM</th> </tr> <tr> <td>REC3C8-02305-0</td> <td>3C8-02305-0</td> </tr> </table> <p>M40D2 / B M50D2 / B</p>	REF	OEM	REC3C8-02305-0	3C8-02305-0	
REF	OEM				
REC3C8-02305-0	3C8-02305-0				

SISTEMA DE ADMISIÓN	INTAKE SYSTEM	SISTEMA ASPIRAZIONE	SYSTÈME D'ADMISSION
---------------------	---------------	---------------------	---------------------

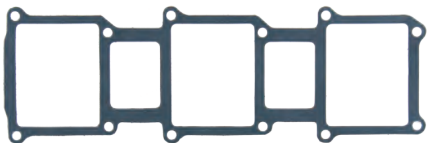
JUNTAS DE ADMISIÓN	GASKET, INTAKE	GUARNIZIONE ASPIRAZIONE	JOINTS D'ADMISSION
--------------------	----------------	-------------------------	--------------------

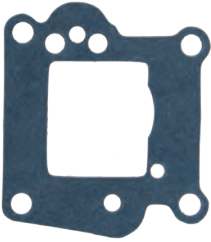
<table border="1"> <tr> <th>REF</th> <th>OEM</th> </tr> <tr> <td>REC17109-ZY6-000</td> <td>HZY6-17109-000</td> </tr> </table> <p>BFT90AK1 BFT75AK1 BFT115A BFT150A</p>	REF	OEM	REC17109-ZY6-000	HZY6-17109-000		<table border="1"> <tr> <th>REF</th> <th>OEM</th> </tr> <tr> <td>REC3T9-02104-0</td> <td>3T9-02104-0</td> </tr> </table> <p>MD70B MD90B</p>	REF	OEM	REC3T9-02104-0	3T9-02104-0	
REF	OEM										
REC17109-ZY6-000	HZY6-17109-000										
REF	OEM										
REC3T9-02104-0	3T9-02104-0										

<table border="1"> <tr> <th>REF</th> <th>OEM</th> </tr> <tr> <td>REC3C8-02104-0</td> <td>3C8-02104-0</td> </tr> </table> <p>M40D2 M50D2</p>	REF	OEM	REC3C8-02104-0	3C8-02104-0		<table border="1"> <tr> <th>REF</th> <th>OEM</th> </tr> <tr> <td>REC3F3-02104-0</td> <td>3F3-02104-0</td> </tr> </table> <p>M60C M70C</p>	REF	OEM	REC3F3-02104-0	3F3-02104-0	
REF	OEM										
REC3C8-02104-0	3C8-02104-0										
REF	OEM										
REC3F3-02104-0	3F3-02104-0										

# UNIDADES DE TRANSMISIÓN UNIT DRIVES & COMPONENTS

# UNITÀ DI TRASMISSIONE EMBASES ET PIÈCES

DESPIECE COLAS

GEAR CASE PARTS

PARTI PIEDI

PIECES D'EMBASES

4T MFS8 • MFS9.8  
STROKES

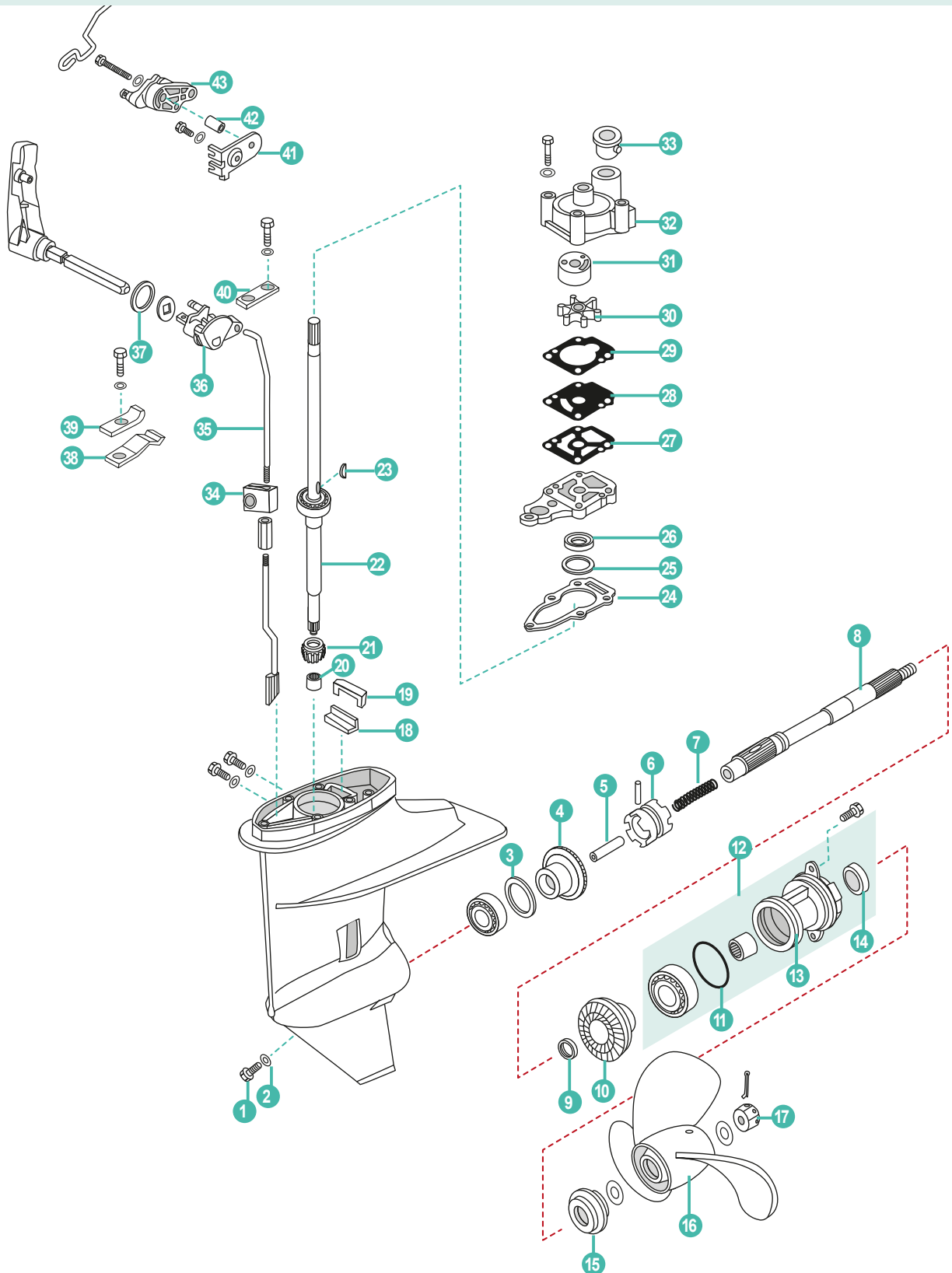

TOHATSU

RECAMBIOS  
MARINOS

	REF	OEM				
1	REC90340-08002	332-60005-2	TAPÓN DRENAJE	PLUG, OIL HOSE	CONNETTORE	BOUCHON DE VIDANGE
2	REC90430-08020	332-60006-0	JUNTA	GASKET	GUARNIZIONE	JOINT
3	PAF8-04000012-1	369-64014-0	GRUESO 0.10mm	SHIM 0.10mm	SPESSORE 0.10mm	CALE 0.10 mm
	PAF8-04000012-2	369-64015-0	GRUESO 0.15mm	SHIM 0.15mm	SPESSORE 0.15mm	CALE 0.15mm
4	PAF8-04010000	3B2-64010-0	PIÑÓN ADELANTE	GEARM FORWARD	PIGNONE AVANTI	PIGNON DE MARCHE AVANT
5	PAF8-04000305	369-64223-0	PIN	PIN CLUTCH	SPINOTTO	PIN
6	PAF8-04000303	3B2-64215-0	SELECTOR	CLUTCH, DOG	SELETTORE	CRABOT
7	PAF8-04000302	3V1-64221-0	MUELLE	SPRING, CLUTCH	MOLLA	RESSORT
8	PAF8-04000301	3V1-64211-0	EJE HÉLICE	SHAFT, PROPELLER	ASSE ELICHE	ARBRE D'HELICE
9	PAF8-04000012	369-64032-0	ARANDELA	WASHER	RONDELLA	RONDELLE
10	PAF8-04000014	3B2-64030-0	PIÑÓN ATRÁS	GEAR REVERSE	PIGNONE MARCIA INDIETRO	PIGNON DE MARCHE ARRIÈRE
11	PAF8-04040002	345-65015-0	TÓRICA	O-RING	ANELLO	JOINT TORIQUE
12	PAF8-04040000	3B2S60100-0	DIÁBOLO	COVER ASSY	DIABOLO	DIABOLO COMPLET
13	PAF8-04040001	3B2S60101-0	DIÁBOLO	COVER, LOWE CASING	DIABOLO	DIABOLO
14	PAF8-04040004	369-60111-0	RETÉN	OIL SEAL	PARAOLIO	JOINT SPI
15	PAF8-04000019	3B2-64230-1	GRUESO	CUSHION, PROPELLER	SPESSORE	CALE
16	PAF8-04050000	3B2W64517-0	HÉLICE	PROPELLER ASSY	ELICHE	HELICE
17	PAF15-06000016	369-64121-0	TUERCA	NUT, HEXAGON	DADO	ÉCROU
18	PAF8-04000015	3V1-60042-0	GUÍA SELLO DE GOMA	GUIDE RUBBER SEAL	GUIDA PARAOLIO	GUIDE EN CAOUTCHOUC
19	PAF8-04000016	3V1-60041-0	SELLO DE GOMA	WATER ENVELOP	PARAOLIO	SUPPORT EN CAOUTCHOUC
20	PANSKFJ-1516	3V1-60211-0	RODAMIENTO	BEARING	CUSCINETTO	ROULEMENT
21	PAF8-04000003	3B2-64020-0	PIÑÓN DE ATAQUE	INITIATIVE GEAR	PIGNONE ATTACCO	PIGNON D'ATTAQUE
22	PAF8-04020001L	3V1-64307-1	EJE VERTICAL L	DRIVE SHAFT L	ASSE VERTICALE L	ARBRE DE COMMANDE L
	PAF8-04020001S	3V1-64306-1	EJE VERTICAL S	DRIVE SHAFT S	ASSE VERTICALE S	ARBRE DE COMMANDE S
23	PAF8-04000021	3B2-65022-0	PIN	PIN, DOWER	SPINOTTO	PIN
24	PAF8-04000005	3B2-65020-0	JUNTA	GASKET, WATER PUMP SEAT	GUARNIZIONE	JOINT
25	PAF8-04000004-1	3B2-64023-0	GRUESO 0.10 mm	SHIM 0.10mm	SPESSORE 0.10 mm	CALE 0.10 mm
26	PAF8-04000101	309-60111-0	RETÉN	OIL SEAL	PARAOLIO	JOINT SPI
27	PAF8-04000006	3B2-65029-0	JUNTA	GASKET, OUTER PLATE	GUARNIZIONE	JOINT
28	PAF8-04000007	3B2-65025-0	PLACA	OUTER PLATE	PIASTRA	PLAQUE
29	PAF8-04000008	3B2-65018-0	JUNTA	GASKET, OUTER PLATE	GUARNIZIONE	JOINT
30	PAF8-04000200	3B2-65021-1	IMPULSOR	IMPELLER	GIRANTE	TURBINE
31	PAF8-04000010	3B2-65011-0	CASQUILLO	INNER SHELL, WATER PUMP	BOCCOLA	COUVERCLE, POMPA À EAU
32	PAF8-04000009	3B2-65016-0	BOMBA DE AGUA	WATER PUMP	POMPA D'ACQUA	POMPA À EAU
33	PAF8-04000013	3B2-65016-0	RETÉN	SEAL	TENUTA	JOINT DE TUBE D'EAU
34	PAF8-03000011	3V1-66302-0	SEGURO	LOCK BLOCK	BLOCCAGGIO	SUPPORT TIGE DE CHANGEMENT DE VITESSE
35	PAF8-03000010	3V1-66211-0	EJE DEL CAMBIO	SHIFT ROD	ASSE CAMBIO	TIGE CHANGEMENT DE VITESSE
36	PAF8-03010003	3V1-66225-0	SEGURO DEL EJE	BLOCK SHIFT ROD	BLOCCAGGIO ASSE	TIGE DE BLOCAGE
37	PAF8-03010001	3V1-66187-0	ARANDELA	WASHER, HANDLE	RONDELLA	RONDELLE
38	PAF8-03010005	3B2-66113-0	TOPE	STOPPER, SHIFT LEVER	TAPPO	LEVIER
39	PAF8-03010006	3C8-66116-0	PLACA	PLATE, SHIFTLIVER STOPPER	PIASTRA	CONTRE PLAQUE LEVIER CAHNGEMENT VITESSE
40	PAF8-03010007	3B1-66145-0	PLACA	PLATE	PIASTRA	PLAQUE
41	PAF8-05000020	3V1-63508-0	PLACA	PALTE	PIASTRA	PLAQUE
42	PAF8-05000018	346-67114-0	CASQUILLO	PLATE ACCELEROGRAPH ENFOPCE	BOCCOLA	PLAQUE SUPPORT LEVIER PRINCIPAL
43	PAF8-05000019	3V1-63622-0	POLEA	MAIN PULLEY	PULEGGIA	POULIE

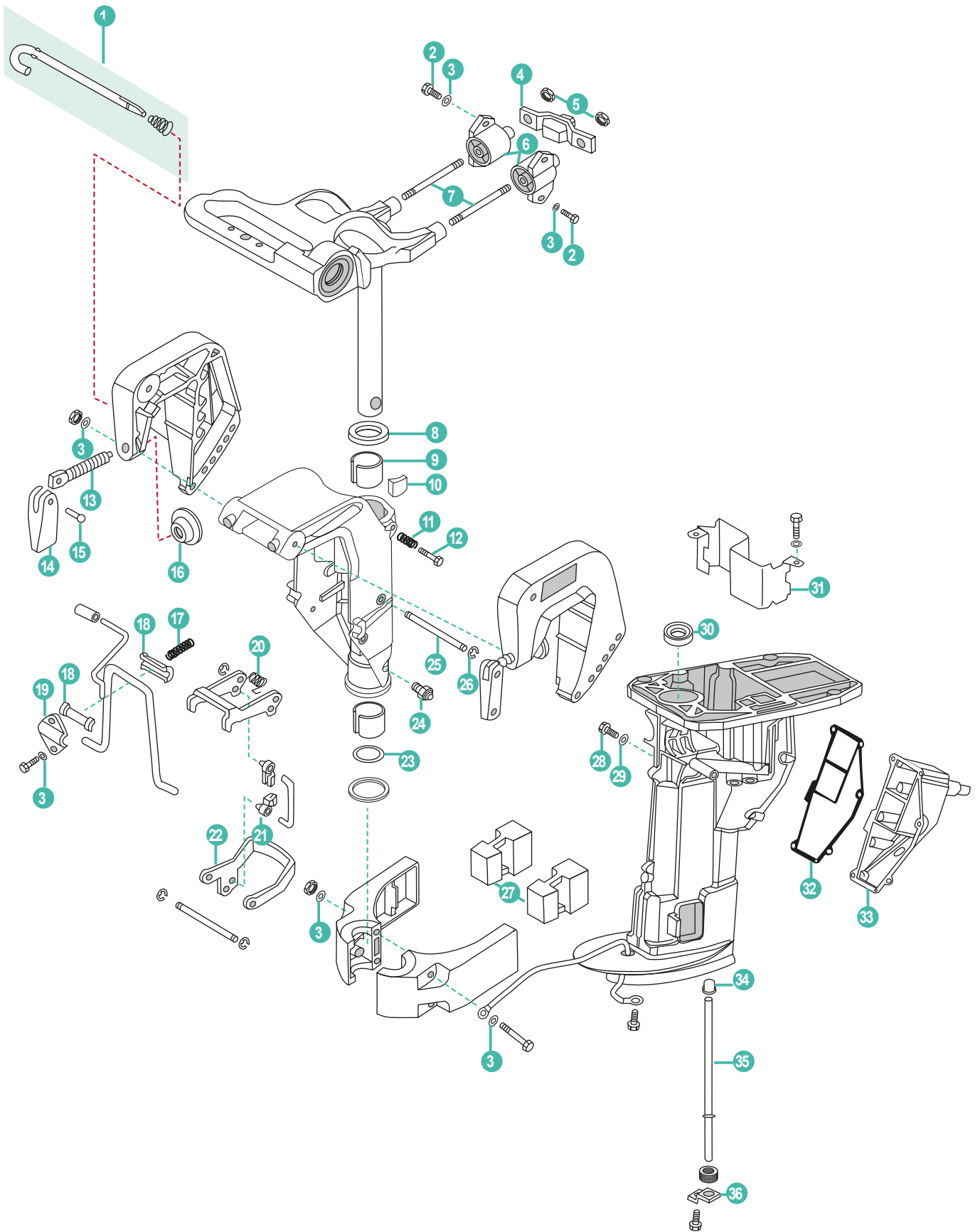

	REF	OEM				
1	PAF8-01010200	350-62121-1 369-62122-2	GANCHO DE CIERRE	THRUST ROD ASSY	ASSE DE CHIUSSURA	CROCHET DE FERMETURE
2	PAGB/T5783-M6X20	910184-5620	TORNILLO	BOLT M6x20	VITE	VIS
3	PAGB/T97.1-6	910184-5620	ARANDELA	WASHER	RONDELLA	RANDELLE
4	PAF8-00000100	3V1-61333-1	SILENBLOCK	ABSORBER (FRONT)	SILENBLOCK	SILENBLOCK
5	PAGB/T889.1-M8	3V1-61324-0	TUERCA M8	NUT M8	DADO M8	ÉCROU M8
6	PAF8-02000100	3V1-61301-1 940113-0800	SILENBLOCK	ABSORBER ASSY	SILENBLOCK	SILENBLOCK
7	PAF8-01000003	3V1-61313-0	TORNILLO M8x65	DICEPHALOUS BOLT M8x65	VITE M8x65	VIS M8x65
8	PAF8-01000001	350-62423-0	ARANDELA	WASHER, ROTARY BRACKET	RONDELLA	RONDELLE
9	PAF8-01000002	350-62417-0	CASQUILLO	BUSHING	BOCCOLA	ENTRETOISE
10	PAF8-01000100	345-62441-0	SEGURO DE CIERRE	LOCKING BLOCK ASSY	CHIUSURA SICUREZA	BLOC DE VERROUILLAGE
11	PAF8-01010102	346-62421-1	MUELLE	SPRING, LOCKING	MOLLA	RESSORT
12	PAGB/T5783-M8X30	910113-0830	TORNILLO M8X30	BOLT M8x30	VITE M8X30	VIS M8X30
13	PAF4-01010002	398-62103-0	TORNILLO	CLAMP SCREW	VITE	VIS
14	REC6L8-G3118-01	332S62102-1	MANETA	CLAMP HANDLE, STERN	MANIGLIA	POIGNEE DE BLOCAGE
15	PAF4-01010005	3C8-62104-1	RIBETE	RIVET, CLAMP HANDLE	RIVETTO	RIVET
16	PAF4-01010003	332-62101-0	ARANDELA	CLAMP PAD	RONDELLA	RONDELLE
17	PAF8-01010104	369-66112-1	MUELLE	SPRING, SUPPORT	MOLLA	RESSORT
18	PAF8-01010103	393-62437-0	PASADOR	PIN	PIN	PIN
19	PAF8-01010105	369-62439-1	PLACA	PRESS PLATE	PIASTRA	PLAQUE
20	PAF8-01010109	3B2-66315-0	MUELLE	SPRING, WREST	MOLLA	RESSORT
21	PAF8-01010112	3K9-05223-0	ADAPTADOR	TIE-IN, CONNECTING ROD	ADATTATORE	EMBOUT DE CABLE
22	PAF8-01010106	3V1-66313-0	UÑA	OUTER FRAME, ROTARY BRACKET	CORNICE ESTERNA	CADRE EXTERIEUR POUR SUPPORT ROTATIF
23	PAJASOF40435-022	350-62415-0	RETÉN	O-RING Ø22.4xØ3.5	TENUTA ANELLO	JOINT
24	PAGB/T7940.1-M6	344-67177-0	ENGRASADOR M6	OILER M6	INGRASSATORE M6	GRAISSEUR M6
25	PAF8-01010108	3B2-66321-1	EJE	SHAFT, ROTARY BRACKET	ASSE	AXE
26	PAGB/T896-5	945303-0500	CLIP	CIRCLIP	CLIP	CLIP
27	PAF8-00000002	3V1-61302-0	AMORTIGUADOR	ABSORBER	AMMORTIZZATORE	SILENT BLOC
28	PAF15-04000002	3R3-07405-1	TAPÓN	BOLT, OIL DRAIN	TAPPO	BOUCHON
29	PAF15-04000003	3R3-07406-0	JUNTA	GASKET	GUARNIZIONE	JOINT
30	PAF8-02000002	3B2-01215-0	RETÉN	OIL SEAL	PARAOILIO	JOINT SPI
31	PAF8-02000003	3V1-07440-0	SEPARADOR CARTER	CLAPBOARD, OIL SUMP	ASSICELLA, COPPA OLIO	PLAQUE GUIDE
32	PAF8-02000004	3V1-61220-0	JUNTA TAPA DE ESCAPE	GASKET, EXHAUST OUTER COVER	GUARNIZIONE COPERCHIO SCARICO	JOINT DE COUVERCLE EXT ECHAPPEMENT
33	PAF8-02000005	3V1-61208-0	TAPA ESCAPE	EXHAUST OUTER COVER	COPERCHIO SCARICO	COUVERCLE EXT ECHAPPEMENT
34	PAF8-02000007	3V1-65206-0	RETÉN TUBO DE AGUA	UPPER SEAL, WATER PIPE	TENUTA, TUBO ACQUA	JOINT SUPERIEUR TUBE D'EAU
35	PAF8-02000006(L)	3V1-65110-0	TUBO L	WATER PIPE L	TUBO L	TUYAU D'EAU L
	PAF8-02000006(S)	3V1-65100-0	TUBO S	WATER PIPE S	TUBO S	TUYAU D'EAU S
36	PAF8-02000009	3V1-65203-0	PLACA TUBO DE AGUA	PLATE, WATER PIPE	PIASTRA, TUBO ACQUA	PLAQUE PIPE D'EAU



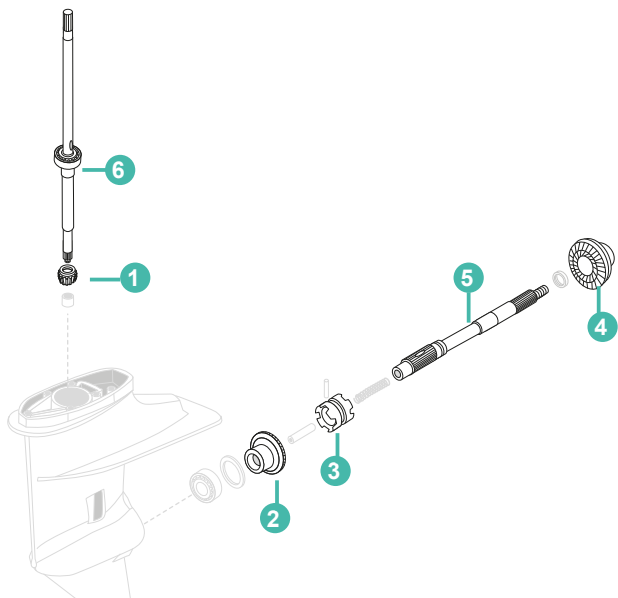

GUÍA PIEZAS COLA

STERN DRIVE  
COMPONENTS GUIDE

GUIDA RICAMBI  
PIEDI

GUIDE PIECES  
D'EMBASE

	1	2	3	4	5	6 S	6 L
M2.5A, B, A2	REC43-16138	REC43-812944					
M3.5A, B, A2, B2	REC43-16138	REC43-812944					
M4C M5B, BS	REC43-16138	REC43-812944		REC43-8129451	REC44-195133	REC45-161351	REC8M0076368
MFS4, 5, 6A2, B, C	REC43-16138	REC43-812944		REC43-8129451	REC44-195133	REC45-161351	REC8M0076368
MFS8, 9.8B	PAF8-04000003	PAF8-04010000		PAF8-04000014	PAF8-04000301		
MFS8A2-3 MFS9.8A2-3 M9.9	PAF8-04000003	PAF8-04010000	PAF8-04000303	PAF8-04000014	PAF8-04000301	PAF8-04020001S	PAF8-04020001L
M15D2 M18E2 MFS9.9B2	REC43-803740	REC43-803739		REC43-803741	REC879147T96	REC45-803738	REC45-8037381
MFS15B2 MFS18B2	REC43-803740T02	REC43-803739T03		REC43-803741T03	REC879147T96		

# SISTEMA DE PROPULSIÓN PROPULSION SYSTEM

# SISTEMA DI PROPULSIONE SYSTEME DE PROPULSION

HÉLICES ALUMINIO E INOXIDABLE DE 3 Y 4 PALAS	3 & 4 BLADE ALUMINIUM & SS PROPELLERS	ELICHE ALLUMINIO E INOX DA 3 E 4 PALE	HELICE ALUMINIUM ET INOX 3 ET 4 PALES
CÓDIGO DE REFERENCIAS	PART NO. CODING SYSTEM	SISTEMA DI CODICE	CODAGE DES REFERENCES
<p>1. Mercury, Mariner 2. Johnson, Evinrude 3. Yamaha 4. Suzuki 5. Tohatsu 6. 7. 8. Volvo Penta 9. Rubex System</p>	<p>0.5, 6, 8 and 9.8 HP Group 1. A Group 2. B Group 3. C Group 4. D Group 5. E Group 6. F Group 7. VP (Std. Hub) 8. VP (Long Hub)</p>	<p>1. AL 2. Saturn (INOX   Stainless Steel) 3. New Saturn (INOX   Stainless Steel) 4. Titan (INOX   Stainless Steel) 5. HR Titan (INOX   Stainless Steel) 6. Scorpion (INOX   Stainless Steel) 7. Lector (INOX   Stainless Steel)</p>	<p>1. 3R Rubber Hub 2. 3L Rubber Hub 3. 4R Rubber Hub 4. 4L Rubber Hub</p>



## AMITA 3



Hélice de aluminio con núcleo de goma de gran resistencia.

Aluminum propeller with heavy duty rubber hub.

Eliche di alluminio con mozzi in gomma ad alta resistenza.

Hélice en aluminium avec moyeu en caoutchouc



## AMITA 4



Hélices de aluminio con núcleo de goma de gran resistencia. Van muy suaves a poca velocidad y hace el barco muy manejable con la mar picada.

Aluminum propeller with heavy duty rubber hub. Smoother low speed makes the offshore boating activity much easier.

Eliche di alluminio con mozzo in gomma ad alta resistenza. Molto morbido a bassa velocità e rende la barca molto maneggevole con mare cattivo.

Hélice en aluminium avec moyeu en caoutchouc. Permet d'aller doucement à basse vitesse et rende le bateau très maniable lorsque la mer est agitée



## NEW SATURN



Hélices de acero inoxidable. Ofrece buena aceleración y rendimiento. Tamaño más pequeño que ofrece un diámetro extragrande.

Stainless steel propeller. Offers good acceleration & all-round performance. Smaller pitch sizes offered in extra large diameter with increased blade area.

Eliche di acciaio inox. Buona accelerazione. Piccole dimensioni che offre un più grande diametro.

Hélice inox, offrant de bonnes accélérations et performances. Taille de pas réduite pour les modèles de grands diamètres avec une surface de pale plus importante.

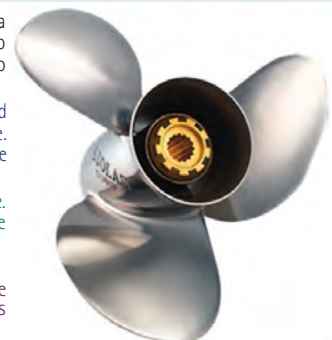

GUÍA DE HÉLICES  
CON NÚCLEO INTEGRADO

PROPELLERS APPLICATION  
WITH RUBBER HUB

GUIDA ELICHE  
CON MOZZO

GUIDE DES HELICES  
ET MOYEUX

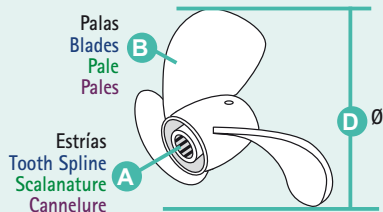

Strokes	R.O. OEM	A B D P R					AL		INOX STAINLESS STEEL
		AMITA 3		AMITA 4		NEW SATURN			
5	✓				7				
4, 5, 6	✓		3	7,8	8	R	SOL5011-078-07 SOL5011-078-08		
		3B2-64513-0			6,5		SOL5011-085-07		
8, 9'8	✓	3B2-64515-0	12	3	8,5	7,5	R	SOL5011-085-08	
		3B2-64517-0			8,5		SOL5011-085-09		
		362-64105-0			6,9		SOL5111-093-07		
9'9, 12, 15, 18	✓	362-64103-0			7,8		SOL5111-093-08		
		362-64101-0			8,8		SOL5111-093-09		
			14	3	9,2	9,1	R	SOL5111-093-09	
9'9, 15, 18, 20	✓	362-64108-0			9,8		SOL5111-093-10		
					11		SOL5111-093-11		
		346-64101-5			9,8	9,3		SOL5211-099-09	
		346-64102-5			9,8	10,2		SOL5211-099-10	
25, 30	✓	346-64103-5			9,8	11,3	R	SOL5211-099-11	
					9,9	12		SOL5211-099-12	
		346-64104-5			9,8	13,1		SOL5211-099-13	
					12,2	7		SOL5311-122-07	
		361-64113-0			12,2	8		SOL5311-122-08	
		361-64114-0			12,1	9		SOL5311-121-09	SOL5313-118-09
		348-64102-0			11,6	11		SOL5311-116-11	SOL5313-111-11
35, 40, 50, 55	✓	348-64103-0			11,4	12		SOL5311-114-12	SOL5313-108-12
		3E3-64528-0	13	3	11,1	13	R	SOL5311-111-13	SOL5313-105-13
		3E3-64536-0			11,1	14		SOL5311-111-14	SOL5313-105-14
					11	15		SOL5311-110-15	
					11	16		SOL5311-110-16	
					11	17		SOL5311-110-17	
		3B7-64523-1			14	11		SOL3411-140-11	
		3B7-64527-1			13,75	13		SOL3411-138-13	SOL3413-133-13
60, 70, 90, 115, 120, 140	✓	3C7-64536-0			13,5	15		SOL3411-135-15	SOL3413-130-15
		3C7-64541-0	15	3	13,25	17	R	SOL3411-133-17	SOL3413-128-17
		3C7-64554-0			13	19		SOL3411-130-19	SOL3413-125-19
					13	21		SOL3411-130-21	SOL3413-125-21
									SOL3431-135-15
									SOL3431-133-17
									SOL3431-130-19
									SOL3431-130-21



- P** Paso  
Pitch  
Passo  
Pas
- R** Rotación L (izquierda) R (derecha)  
Rotation L (left) R (Right)  
Rotazione L (SX) R (DX)  
Rotation L (gauche) R (droit)

**NÚCLEO INTERCAMBIABLE INTERCHANGEABLE HUB**

**MOZZO INTERCAMBIABILE MOYEU INTERCHANGEABLE**

	A	REF	
35HP (35B only) (1984+) 40HP (1984+), 50HP (All except 50C) (1992+) 50HP (50C only) (1987-91)	13	SOLRBX-116	C
55HP (1981-88) 60A (1986+) 70A/70B (1981+)	13	SOLRBX-112	C
90-140HP, (1987+)	13	SOLRBX-109	D



**RUBEX**

**HÉLICES PARA NÚCLEO INTERCAMBIABLE**

**PROPELLERS FOR INTERCHANGEABLE HUB**

**ELICHE PER MOZZO INTERCAMBIABILE**

**HELICES AVEC MOYEU INTERCHANGEABLE**

	B	D	P	R	AL
<b>C</b> 30-75 HP	3	11.4	12	R	SOL9311-114-12
		11.1	13	R	SOL9311-111-13
		14	9	R	SOL9411-140-09
		14	11	R	SOL9411-140-11
<b>D</b> 40-140 HP	3	13.75	13	R	SOL9411-138-13
		13.50	15	R	SOL9411-135-15
		13.25	17	R	SOL9411-133-17
		13.2	19	R	SOL9411-132-19
		13.2	21	R	SOL9411-132-21
		15.5	11	R	SOL9511-155-11
<b>E</b> 135-350 HP	3	15.3	13	R	SOL9511-153-13
		16	13	R	SOL9511-160-13
		15	15	R	SOL9511-150-15
		15	15	L	SOL9512-150-15
		14.8	17	R	SOL9511-148-17
		14.8	17	L	SOL9512-148-17
		14.5	19	R	SOL9511-145-19
		14.5	19	L	SOL9512-145-19
		14.3	21	R	SOL9511-143-21
		14.3	21	L	SOL9512-143-21

	B	D	P	R	INOX STAINLESS STEEL
<b>D</b> 40-140 HP	3	13 <sup>3/4</sup>	13	R	SOL9431-138-13
		13 <sup>3/4</sup>	13	L	SOL9432-138-13
		13 <sup>1/2</sup>	15	R	SOL9431-135-15
		13 <sup>1/2</sup>	15	L	SOL9432-135-15
		13 <sup>1/4</sup>	17	R	SOL9431-133-17
		13 <sup>1/4</sup>	17	L	SOL9432-133-17
		13	19	R	SOL9431-130-19
		13	19	L	SOL9432-130-19
		13	21	R	SOL9431-130-21
		13	21	L	SOL9432-130-21
<b>E</b> 90-140 HP	3	14 <sup>1/2</sup>	15	R	SOL9531-145-15
		14 <sup>1/2</sup>	15	L	SOL9532-145-15
		14 <sup>1/4</sup>	17	R	SOL9531-143-17
		14 <sup>1/4</sup>	17	L	SOL9532-143-17
		14	19	R	SOL9531-140-19
		14	19	L	SOL9532-140-19
		14	21	R	SOL9531-140-21
		14	21	L	SOL9532-140-21
		14	23	R	SOL9531-140-23
		14	23	L	SOL9532-140-23
<b>E</b> 135-350 HP	3	15 <sup>3/4</sup>	15	R	SOL9571-158-15
		15 <sup>3/4</sup>	15	L	SOL9572-158-15
		15 <sup>1/2</sup>	17	R	SOL9571-155-17
		15 <sup>1/2</sup>	17	L	SOL9572-155-17
		15 <sup>1/4</sup>	19	R	SOL9571-153-19
		15 <sup>1/4</sup>	19	L	SOL9572-153-19
		15	21	R	SOL9571-150-21
		15	21	L	SOL9572-150-21
		14 <sup>3/4</sup>	23	R	SOL9571-148-23
		14 <sup>3/4</sup>	23	L	SOL9572-148-23

**RUBEX**



Núcleo intercambiable (no incluido).  
Interchangeable hub (not included).  
Mozzo intercambiabile (non incluso).  
Moyeu interchangeable (non inclus)

# REF--> RO / OEM

REF	R.O. / OEM	
<b>C</b>		
CEF500337	HZW1-19210-B04	604
CEF500338	HZV5-19210-003	604
CEF500344	3B2-65021-1	589-604
CEF500377	369-65021-1	589-604
CEF500379	345-65021-1	604
CEF500382	345-65021-0	589-604
CEF500383	334-65021-0	589-604
CEF500388	3B7-65021-2	604
CEF500388	3C7-65021-1	604
CEF500391	HZY3-19210-003	604
CEF500396	309-65021-1	604
CM33860-2181	338-60218-2	606
CM348-60217-0M	348-60217-0	606
CM3B7-602170	3B7-60217-0	606
CM3B7-60218-0	3B7-60218-1	606
CM3C760-2181	3C7760-2181	606
CM3C760-2181A	3C7760-2181	606
CM3C8-60217-0	3C8-60217-1	606
CM3H6-60218-000	3H6-60218-0	606
CM3H6-60218-000A	3H6-60218-0	606
CM3M2-60218-1	3M2-60218-0	606
CM3V1-60217-0	3V1602170	606
CM3V1-60217-0A	3V1602170	606
CM5338602182A0	5338602182A0	606
CM5338602182A0A	5338602182A0	606
CHAL78C		600
CHAL82C		600
CHAL82YC		600
CHAL86C		600
CHAL87YCC		600
CHARA8HC		600

REF	R.O. / OEM	
<b>G</b>		
GS30435		595
GS31001		594
GS31002		594
GS31015	394-702500M	592
GS31016	3B2-702801M	592
GS31017		592
GS31018	3B2-702601M	592
GS31019	99998-0MA2	591
GS31020		591
GS31064		592
GS31065		594
GS31066		594
GS31067		594
GS31068		591
GS31069		591
GS31073		591
GS31088		591
GS31090		590
GS31090		590
GS31095		590
GS31096		590
GS31097		590
GS31099		590
GS31155		594
GS31156		594
GS31157		594
GS31166		594
GS31183		590
GS31187	65770-95541	590
GS31189		590
GS35031		590
GS35032		590
GS31183		442
GS31187		442
GS31189		442
GS35031		442
GS35032		442

REF	R.O. / OEM	
<b>L</b>		
LENS3213		593
LENS3227	99105-20005	593

REF	R.O. / OEM	
<b>N</b>		
NGKB7HS-10	9701-1-1005	600
NGKB8HS-10	9701-1-1006	600
NGKBP7HS-10	9701-1-1010	600
NGKBP7HS-10	9701-1-1013	600
NGKBP7HS-10	9701-1-1014	600
NGKBR7HS-10	9701-1-1015	600
NGKBR8HS-10	9701-1-1110	600
NGKDCPR6E	9701-1-1103	589-600
NGKIKR6G8	9701-1-1121	600
NGKIZFR5J	9791-1-1109	600
NGKIZFR6	9701-1-1111	600
NGKLMAR6C-9	HZZ3-31909-003	600

REF	R.O. / OEM	
<b>P</b>		
PAF15-04000002	3R3-07405-1	625
PAF15-04000003	3R3-07406-0	625
PAF15-06000016	369-64121-0	623
PAF15-07000017	3V1-02011-0	615
PAF15-07000018	3V1-03952-0	615
PAF15-07000031	HZW9-19300-003	603
PAF15-07010100	3H6-07611-0	598-613
PAF15-07010101	3H6-07612-0	613
PAF15-07020005	350-00024-1	615-620
PAF15-07040303	3R0-07238-0	615
PAF15-07040304	3H8-07237-0	615
PAF15-07080000	3AC-02230-0	594
PAF15-07080000	3AD-02230-0	594
PAF15-07080000	3B7-02230-0	594
PAF4-01010002	398-62103-0	625
PAF4-01010003	332-62101-0	625
PAF4-01010005	3C8-62104-1	625
PAF4-04000019	3T5-10131-0	615
PAF4-04000030		591
PAF4-04130101	3AA-05019-0	616
PAF4-04130102	3R1-05131-0	616
PAF4-05000010		591
PAF4-05000300	369-02230-0	595
PAF4-05000300	396-02230-0	595
PAF4-05000300		589
PAF40-0701000E1		594
PAF8-00000002	3V1-61302-0	625
PAF8-00000003	3R3-61017-0	615
PAF8-00000004	3V1-01303-0	615
PAF8-00000100	3V1-61333-1	625
PAF8-00000200	3V1-07421-0	615
PAF8-005030010	3H8-07226-0	615
PAF8-01000001	350-62423-0	625
PAF8-01000002	350-62417-0	625
PAF8-01000003	3V1-61313-0	625
PAF8-01000100	345-62441-0	625
PAF8-01010102	346-62421-1	625
PAF8-01010103	393-62437-0	625
PAF8-01010104	369-66112-1	625
PAF8-01010105	369-62439-1	625
PAF8-01010106	3V1-66313-0	625
PAF8-01010108	3B2-66321-1	625
PAF8-01010109	3B2-66315-0	625
PAF8-01010112	3K9-05223-0	625
PAF8-01010200	350-62121-1	625
PAF8-01010200	369-62122-2	625
PAF8-02000002	3B2-01215-0	625
PAF8-02000003	3V1-07440-0	625
PAF8-02000004	3V1-61220-0	625
PAF8-02000005	3V1-61208-0	625
PAF8-02000006(L)	3V1-65110-0	625
PAF8-02000006(S)	3V1-65100-0	625
PAF8-02000007	3V1-65206-0	625
PAF8-02000009	3V1-65203-0	625
PAF8-02000100	3V1-61301-1	625
PAF8-02000100	940113-0800	625
PAF8-03000010	3V1-66211-0	623
PAF8-03000011	3V1-66302-0	623
PAF8-03010001	3V1-66187-0	623
PAF8-03010003	3V1-66225-0	623
PAF8-03010005	3B2-66113-0	623
PAF8-03010006	3C8-66116-0	623
PAF8-03010007	3B1-66145-0	623
PAF8-04000003	3B2-64020-0	623-626
PAF8-04000004-1	3B2-64023-0	623
PAF8-04000005	3B2-65020-0	623
PAF8-04000006	3B2-65029-0	623
PAF8-04000007	3B2-65025-0	605-623
PAF8-04000008	3B2-65018-0	623
PAF8-04000009	3B2-65016-0	623
PAF8-04000010	3B2-65011-0	605-623
PAF8-04000012	369-64032-0	623
PAF8-04000012-1	369-64014-0	623
PAF8-04000012-2	369-64015-0	623
PAF8-04000013	3B2-65016-0	623
PAF8-04000014	3B2-64030-0	623-626
PAF8-04000015	3V1-60042-0	623
PAF8-04000016	3V1-60041-0	623
PAF8-04000019	3B2-64230-1	623
PAF8-04000021	3B2-65022-0	623
PAF8-04000101	309-60111-0	623
PAF8-04000200	3B2-65021-1	623
PAF8-04000301	3V1-64211-0	623-626
PAF8-04000302	3V1-64221-0	623
PAF8-04000303	3B2-64215-0	623-626
PAF8-04000305	369-64223-0	623
PAF8-04010000	3B2-64010-0	623-626
PAF8-04020001L	3V1-64307-1	623-626
PAF8-04020001S	3V1-64306-1	623-626
PAF8-04040000	3B2S60100-0	623
PAF8-04040001	3B2S60101-0	623

REF	R.O. / OEM	
PAF8-04040002	345-65015-0	623
PAF8-04040004	369-60111-0	623
PAF8-04050000	3B2W64517-0	623
PAF8-05000002	3V1-01024-0	615
PAF8-05000003	172-36008-0	616
PAF8-05000004	3V1-10045-0	589-615
PAF8-05000006	3A0-76079-0	613
PAF8-05000007	3B7-06305-0	613
PAF8-05000008	3V1-02010-1	615
PAF8-05000009	3V1-02104-0	615
PAF8-05000011	3T5-06920-0	613
PAF8-05000012	3V1-06308-0	616
PAF8-05000013	3V1-06302-0	616
PAF8-05000017	98AH10-0120	615
PAF8-05000018	346-67114-0	623
PAF8-05000019	3V1-63622-0	623
PAF8-05000020	3V1-63508-0	623
PAF8-05000021	3R0-66308-0	613
PAF8-05000024	369-00132-0	613
PAF8-05000024	98AB-5-0330	615
PAF8-05000025	369-84398-0	615
PAF8-05000100	3V1-02305-0	615
PAF8-05000200	3V1-06071-0	599-613
PAF8-05000300	3AA-06021-0	598-613
PAF8-05000400	3AA-06060-0	613
PAF8-05000400	3AA-06060-00	601
PAF8-05000400	3AA060600M	601
PAF8-05000500	3V1-06040-0	599-613
PAF8-05000500	3V1060400	599
PAF8-05000500	3V1060400M	599
PAF8-05000600	3AA-06091-0	613
PAF8-05000800	3V1-07410-0	615
PAF8-05010000	3V1B01100-0	615
PAF8-05010002	3H8-02093-0	615
PAF8-05010004	3V1-02305-0	615
PAF8-05010005	346-01032-0	615
PAF8-05010009	3V1-07407-0	615
PAF8-05010012	3V1-00121-0	615
PAF8-05010014	3V1-10060-0	615
PAF8-05010015	3V1-10063-0	615
PAF8-05010016	3V1-10068-0	615
PAF8-05020001	3V1-00030-1	615
PAF8-05020101	3V1-00001-0	615-620
PAF8-05020105	332-00021-0	615
PAF8-05020105	332-00024-0	620
PAF8-05020200	3V1-00040-0	615-620
PAF8-05030001	3V1-07201-0	615
PAF8-05030002	3V1-07202-0	615
PAF8-05030004	3V1-07205-0	615
PAF8-05030005	3AA-07203-0	615
PAF8-05030006	3V1-07221-0	615
PAF8-05030007	3H6-07223-0	615
PAF8-05030008	3V1-07010-0	615
PAF8-05030009	3AA-07225-0	615
PAF8-05030011	3H8-07025-0	615
PAF8-05030012	3V1-07653-0	615
PAF8-05030015	3R3-07227-0	615
PAF8-05030100	3V1B01001-0	615
PAF8-05030200	3V1-07235-0	615
PAF8-05030300	3V1-07600-0	615
PAF8-05030400	3H8-10062-2	615
PAF8-05040000	3V2-03100-2	596
PAF8-05050002	3V1-05259-0	616
PAF8-05050003	3R1-05125-0	616
PAF8-05050004	3AA-05004-0	616
PAF8-05050005	3V1-05104-1	616
PAF8-05050006	3R1-05003-1	616
PAF8-05050007	3R1-05012-0	616
PAF8-05050009	3R1-05007-0	616
PAF8-05050018	3AA-05013-0	616
PAF8-05090000W	3V1-06023-0	599
PAGB/T5783-M6X20	910184-5620	625
PAGB/T5783-M8X30	910113-0830	625
PAGB/T940.1-M6	344-67177-0	625
PAGB/T889.1-M8	3V1-61324-0	625
PAGB/T896-5	945303-0500	625
PAGB/T97.1-6	910184-5620	625
PAJASOF40435-022	350-62415-0	625
PANSKFJ-1516	3V1-60211-0	623
PAT15-04000011	940121-1200	613
PAT3.6-04000006	309-00131-0	615
PH130-0006	3C8-76010-1	600
PH130-0006	3C8760101	600
PH130-0006	3C8760101M	600
PH130-0048	353-76010-4	600
PH130-0061	350-76010-0	600
PH130-0061	3AA760100	600
PH130-0070	HZY3-31200-003	601
PH130-0080	346-76010-0M	600
PH200-T024		602
PH200-WH01		602

TOHATSU

RECAMBIOS MARINOS

REF	R.O. / OEM	
<b>RAC23289-10</b>		593
<b>RAC23299-10</b>		593
<b>RAC320R-RAC-01</b>		593
<b>RAC320R-RAC-03</b>		593
<b>RAC490R-RAC-01</b>	99105-20005-ASY	593
<b>RACPF5510</b>		592
<b>RACRK22628</b>		594
<b>RACS3213</b>		593
<b>RACS3227</b>	99105-20005	593
<b>REC06192-ZY3-000</b>	HZY3-06192-000	605
<b>REC06192-ZY6-000</b>	HZY6-06192-000	605
<b>REC09401-11425</b>		591
<b>REC09401-11425BULK</b>		591
<b>REC10W30U3</b>		595
<b>REC10W30U6</b>		595
<b>REC10W40U3</b>	990C0-10W40-GLN	595
<b>REC10W40U6</b>	990C0-10W40-GLN	595
<b>REC15400-PLM-A01PE</b>	HPLM-15400-PE	596
<b>REC16157</b>	369-65011-0	605
<b>REC16159</b>	369-65025-0	605
<b>REC16253</b>	369-03231-0	597
<b>REC162532</b>	3C8-03125-0	597
<b>REC16275</b>	369-03303-0	596
<b>REC16325</b>	369-03306-0	596
<b>REC16911-ZY3-010</b>	HZY3-16911-010	595
<b>REC16911-ZZ5-003</b>	HZZ5-16911-003	595
<b>REC17109-ZY6-000</b>	HZY6-17109-000	621
<b>REC18-6865</b>		602
<b>REC19210-ZV5-003</b>	HZV5-19210-003	604
<b>REC19210-ZW1-B02</b>	HZW1-19210-B04	604
<b>REC19210-ZY3-003</b>	HZY3-19210-003	604
<b>REC19300-ZV5-043</b>	HZV5-19300-043	603
<b>REC22-8M0001721</b>		591
<b>REC24942</b>		592
<b>REC24950</b>		593
<b>REC24952</b>		593
<b>REC25000</b>		592
<b>REC25010</b>		592
<b>REC25020</b>		592
<b>REC25030</b>		592
<b>REC25W40U3</b>		595
<b>REC26-16051</b>	369-00122-0	608
<b>REC26-161301</b>	346-60111-0	618
<b>REC26-16162</b>	369-60223-0	618
<b>REC26-161622</b>	346-65013-0	618
<b>REC26-16703</b>	369-01215-0	618
<b>REC26-803514</b>	101-00121-0	609
<b>REC26-803667</b>	350-00121-0	618
<b>REC26-85370711</b>	3B2-00051-0	609
<b>REC26-8537072</b>	346-01215-0	618
<b>REC27-16274</b>	369-03302-0	596
<b>REC27-16326</b>	369-03307-0	596
<b>REC27-8555691</b>	3C8-04028-0	596
<b>REC2TU3</b>		595
<b>REC2TU6</b>		595
<b>REC30-16049</b>	9603-3-6204	608-609
<b>REC30-160494</b>	96603-3-6305	610
<b>REC30-16049T01</b>	345-00113-0	611
<b>REC30-898101936</b>	9643-3-6004	619
<b>REC30580-ZV4-013</b>	HZV4-30580-013	599
<b>REC309-01005-2</b>	309-01005-2	617
<b>REC31-16052</b>	350-00042-0	608-610-619
<b>REC31-8036752</b>	338-00042-0	609-619
<b>REC31-813048</b>	369-00043-0	608
<b>REC31-8130482</b>	356-00043-0	611
<b>REC31-855553</b>	3C8-00113-0	612
<b>REC31200-ZY6-003</b>	HZY6-31200-003	601
<b>REC345-00042-0</b>	345-00042-0	611-612-620
<b>REC345-65021-0</b>	345-65021-0	604
<b>REC346-01005-0</b>	346-01005-0	617
<b>REC346-01303-0</b>	350-01303-0	618
<b>REC35-802893Q</b>		592
<b>REC35-802893Q01</b>	3Y7-02234-0	592
<b>REC35-80365M</b>	646-24251-02	595
<b>REC350-01005-0</b>	350-01005-0	617
<b>REC350-01303-0</b>	350-01303-0	618
<b>REC350-61012-1</b>	350-61012-1	618
<b>REC351-01005-0</b>	351-01005-0	617
<b>REC353-06260-0</b>	353-06260-0	601
<b>REC353-06260-0</b>	353-06260-2	601
<b>REC35668-ZY6-003</b>	HZY6-35668-003	598
<b>REC369-06021-0</b>	369-06021-0	598
<b>REC37510-PNB-003</b>	HPNB-37510-003	598
<b>REC39-16054A5</b>	346-00011-0	611-620
<b>REC39-803678A1</b>	350-00011-0	610

REF	R.O. / OEM	
<b>REC39-803678A3</b>	3B2-00011-0	609-619
<b>REC39-8M0055809</b>	3V1-00011-0	615
<b>REC3A0-06040-1</b>	3A0-06040-1	599
<b>REC3A106-2602M</b>	3A106-2402M	601
<b>REC3A106-2602M</b>	3A106-2601M	601
<b>REC3A106-2602M</b>	3A106-2602M	601
<b>REC3B2-01005-0</b>	3B2-01005-0	617
<b>REC3B2-01303-0</b>	3B2-01303-0	618
<b>REC3B2-65021-1</b>	3B2-65021-1	604
<b>REC3B7-65021-2</b>	3B7-65021-2	604
<b>REC3B7-87121-1</b>	3B7-87121-7	617
<b>REC3C8-01005-4</b>	3C8-01005-4	617
<b>REC3C8-01024-0</b>	3C8-01024-0	617
<b>REC3C8-01303-4</b>	3C8-01303-4	618
<b>REC3C8-02104-0</b>	3C8-02104-0	621
<b>REC3C8-02305-0</b>	3C8-02305-0	621
<b>REC3F0-06060-0</b>	3F0-06060-0	601
<b>REC3F0-65029-6</b>	3F0-65029-6	605
<b>REC3F3-01005-0</b>	3F3-01005-0	617
<b>REC3F3-01024-0</b>	3F3-01024-0	617
<b>REC3F3-01303-1</b>	3F3-01303-1	618
<b>REC3F3-02104-0</b>	3F3-02104-0	621
<b>REC3F3-02305-1</b>	3F3-02305-1	604
<b>REC3G2-06040-2</b>	3G2-06040-2	599
<b>REC3G2-06060-2</b>	3G2-06060-2	601
<b>REC3G3-06021-1</b>	3G3-06021-1	598
<b>REC3T5-87121-6</b>	3T5-87121-6	617
<b>REC3T9-01005-0</b>	3T9-01005-0	617
<b>REC3T9-01032-0</b>	3T9-01032-0	604
<b>REC3T9-02104-0</b>	3T9-02104-0	621
<b>REC40135</b>		595
<b>REC40145</b>		595
<b>REC40155</b>		595
<b>REC40165</b>		595
<b>REC41-16056</b>	369-00021-0	608-619
<b>REC41-16056</b>	3C8-00021-0	612
<b>REC41-803680002</b>	350-00021-0	610-619
<b>REC41-803680003</b>	3C8-00021-0	611-620
<b>REC41-8036801</b>	3B2-00021-0	609-619
<b>REC41-825713002</b>	332-00021-0	610-619
<b>REC43-16138</b>	309-64020-0	626
<b>REC43-803739</b>	350-06401-0	626
<b>REC43-803739T03</b>	3H8-640100	626
<b>REC43-803740</b>	350-06401-0	626
<b>REC43-803740T02</b>	3H8-64020-0	626
<b>REC43-803741</b>	362-64215-0	626
<b>REC43-803741T03</b>	3H8-64030-0	626
<b>REC43-812944</b>	369-64010-2	626
<b>REC43-8129451</b>	369-64030-2	626
<b>REC44-195133</b>	369-64211-1	626
<b>REC45-161351</b>	369-64301-0	626
<b>REC45-803738</b>	350-64301-0	626
<b>REC45-8037381</b>	350-64302-0	626
<b>REC53-16057</b>	334-00024-1	611-612-620
<b>REC53-16057</b>	350-00024-1	608-609-610-619-620
<b>REC5GH-13440-00</b>	3R3R76150M	589-596
<b>REC5GH-13440-00</b>	3R0-07615-0	596
<b>REC5GH-13440-00</b>	5GH-13440-00	596
<b>REC5W40U3</b>		595
<b>REC5W40U6</b>		595
<b>REC629-803674</b>	350-00040-0	610-619
<b>REC629-8036741</b>	3B2-00040-0	609-619
<b>REC629-813047T01</b>	336-00040-1	611-620
<b>REC650-24351-51</b>		591
<b>REC66M-W0093-01</b>	3V1-87122-0	597
<b>REC696-W0093-00</b>	345-87122-4	597
<b>REC6A1-W0093-01</b>	3F0-87122-2	597
<b>REC6E5-24351-51</b>		591
<b>REC6G1-W0093-00</b>	369-87122-1	597
<b>REC6G1-W0093-00</b>	3B2-87122-0	597
<b>REC6H1-W0093-01-00</b>	346-87122-0	597
<b>REC6H3-W0093-02</b>	346-87122-0	597
<b>REC6H4-W0093-03</b>	3F3-87122-1	597
<b>REC6L2-W0093-00</b>	3G2-87122-2	597
<b>REC6L8-G3118-01</b>	332S62102-1	625
<b>REC70720</b>		594
<b>REC779-803677</b>	350-00001-0	619
<b>REC779-803677</b>	350-00001-1	610
<b>REC779-803677T02</b>	351-00001-1	610-619
<b>REC779-804886</b>	3B2-00001-0	609-619
<b>REC779-879194T01</b>	346-00001-1	611-620
<b>REC779-96152</b>	3C8-00001-3	620
<b>REC779-9615T</b>	369-00001-0	608-619
<b>REC779-9615T</b>	3C8-00001-3	612
<b>REC803673</b>	350-00061-0	610

REF	R.O. / OEM	
<b>REC803751</b>	350-65011-1	605
<b>REC804898</b>	3B2-63600-1	603
<b>REC80W90U3</b>	990A0-01E81-01Q	595
<b>REC80W90U6</b>	990A0-01E81-01Q	595
<b>REC813046002</b>	369-00061-0	608
<b>REC8130461</b>	334-00061-0	611
<b>REC84419M</b>	345-87122-0	597
<b>REC8537312</b>	350-04005-0	596
<b>REC855676002</b>	3R3-01030-0	589-603
<b>REC855686</b>		592
<b>REC879147796</b>	362-64211-0	626
<b>REC8M0065585</b>	350-01215-5	618
<b>REC8M0076368</b>	369-64301-0	626
<b>REC8M0080349</b>	346-00011-0	612-620
<b>REC8M0080357</b>	351-00011-0	608-610-619
<b>REC90340-08002</b>	332-60005-2	623
<b>REC90340-08020</b>	332-60006-0	623
<b>REC90794-46866</b>		594
<b>REC90794-46868</b>		594
<b>RECOBRACKET</b>		592
<b>RECOBELEMENT</b>		593
<b>RECOFILALU</b>		593
<b>RECOFILTER</b>		593
<b>RECYS-225-15</b>		594
<b>RM35-802893Q</b>		592
<b>RM92-858026QB1U6</b>		595
<b>RM92-858027QB1U3</b>		595
<b>RM92-8M0086220U6</b>		595
<b>RM92-8M0086221U3</b>		595
<b>S</b>		
<b>SIE18-8013</b>		590
<b>SIE18-8015</b>		590
<b>SOL3411-130-19</b>	3C7-64554-0	628
<b>SOL3411-130-21</b>		628
<b>SOL3411-133-17</b>	3C7-64541-0	628
<b>SOL3411-135-15</b>	3C7-64536-0	628
<b>SOL3411-138-13</b>	3B7-64527-1	628
<b>SOL3411-140-11</b>	3B7-64523-1	628
<b>SOL3413-125-19</b>	3C7-64554-0	628
<b>SOL3413-125-21</b>		628
<b>SOL3413-128-17</b>	3C7-64541-0	628
<b>SOL3413-130-15</b>	3C7-64536-0	628
<b>SOL3413-133-13</b>	3B7-64527-1	628
<b>SOL3431-130-19</b>	3C7-64554-0	628
<b>SOL3431-130-21</b>		628
<b>SOL3431-133-17</b>	3C7-64541-0	628
<b>SOL3431-135-15</b>	3C7-64536-0	628
<b>SOL5011-078-07</b>		628
<b>SOL5011-078-08</b>		628
<b>SOL5011-085-07</b>	3B2-64513-0	628
<b>SOL5011-085-08</b>	3B2-64515-0	628
<b>SOL5011-085-09</b>	3B2-64517-0	628
<b>SOL5111-093-07</b>	362-64105-0	628
<b>SOL5111-093-08</b>	362-64103-0	628
<b>SOL5111-093-09</b>	362-64101-0	628
<b>SOL5111-093-10</b>	362-64108-0	628
<b>SOL5111-093-11</b>		628
<b>SOL5211-099-09</b>	346-64101-5	628
<b>SOL5211-099-10</b>	346-64102-5	628
<b>SOL5211-099-11</b>	346-64103-5	628
<b>SOL5211-099-12</b>		628
<b>SOL5211-099-13</b>	346-64104-5	628
<b>SOL5311-110-15</b>	3E3-64536-0	628
<b>SOL5311-110-16</b>		628
<b>SOL5311-110-17</b>		628
<b>SOL5311-111-13</b>	3E3-64528-0	628
<b>SOL5311-111-14</b>	3E3-64536-0	628
<b>SOL5311-114-12</b>	348-64103-0	628
<b>SOL5311-116-11</b>	348-64102-0	628
<b>SOL5311-121-09</b>	361-64114-0	628
<b>SOL5311-122-07</b>		628
<b>SOL5313-105-13</b>	361-64113-0	628
<b>SOL5313-105-14</b>	3E3-64528-0	628
<b>SOL5313-108-12</b>	348-64103-0	628
<b>SOL5313-111-11</b>	348-64102-0	628
<b>SOL5313-118-09</b>	361-64114-0	628
<b>SOL9311-111-13</b>		629
<b>SOL9311-114-12</b>		629
<b>SOL9411-132-19</b>		629
<b>SOL9411-132-21</b>		629
<b>SOL9411-133-17</b>		629
<b>SOL9411-135-15</b>		629
<b>SOL9411-138-13</b>		629
<b>SOL9411-140-09</b>		629
<b>SOL9411-140-11</b>		629

REF	R.O. / OEM	REF	R.O. / OEM
SOL9431-130-19	629	SOL9571-148-23	629
SOL9431-130-21	629	SOL9571-150-21	629
SOL9431-133-17	629	SOL9571-153-19	629
SOL9431-135-15	629	SOL9571-155-17	629
SOL9431-138-13	629	SOL9571-158-15	629
SOL9432-130-19	629	SOL9572-148-23	629
SOL9432-133-17	629	SOL9572-150-21	629
SOL9432-135-15	629	SOL9572-153-19	629
SOL9432-138-13	629	SOL9572-155-17	629
SOL9511-143-21	629	SOL9572-158-15	629
SOL9511-145-19	629	SOLRBX-109	629
SOL9511-148-17	629	SOLRBX-112	629
SOL9511-150-15	629	SOLRBX-116	629
SOL9511-153-13	629		
SOL9511-155-11	629	TEN01250	338-60218-2 589-607
SOL9511-160-13	629	TEN01251	369-60218-1 607
SOL9531-140-19	629	TEN01252	348-60217-0 607
SOL9512-143-21	629	TEN01253	3C8-60217-1 589-607
SOL9512-145-19	629	TEN01254	3C7-60218-2 607
SOL9512-148-17	629	TEN01255	3B7-60217-0 607
SOL9512-150-15	629	TEN01256	3B7-60218-1 589-607
SOL9531-140-21	629	TEN01257	3M2-60218-0 607
SOL9531-140-23	629	TEN01258	5338602182A0 589-607
SOL9531-143-17	629	TEN01259	3H6-60218-0 589-607
SOL9531-145-15	629	TEN01260	3B7-60217-0 589-607
SOL9532-140-19	629	TEN01408	HZV4-12155-A00 607
SOL9532-140-21	629	TEN01408/1	HZV5-12155-000 607
SOL9532-140-23	629	TRI305-0386	590
SOL9532-143-17	629	TRI305-0566	590
SOL9532-145-15	629		

**RO / OEM --> REF**

R.O. / OEM	REF	R.O. / OEM	REF	R.O. / OEM	REF
101-00121-0	REC26-803514	346-64102-5	SOL5211-099-10	351-00011-0	REC8M0080357 608-610-619
172-36008-0	PAF8-05000003	346-64103-5	SOL5211-099-11	351-01005-0	REC351-01005-0 617
309-00131-0	PAT3.6-04000006	346-64104-5	SOL5211-099-13	353-06260-0	REC353-06260-0 601
309-01005-2	REC309-01005-2	346-65013-0	REC26-161622	353-06260-2	REC353-06260-0 601
309-60111-0	PAF8-04000101	346-67114-0	PAF8-05000018	353-76010-4	PH130-0048 600
309-64020-0	REC43-16138	346-76010-0M	PH130-0080	356-00043-0	REC31-8130482 611
309-65021-1	CEF500396	346-87122-0	REC6H1-W0093-01-00	361-64113-0	SOL5311-122-08 628
332-00021-0	PAF8-05020105	346-87122-0	REC6H3-W0093-02	361-64114-0	SOL5311-121-09 628
332-00021-0	REC41-825713002	348-60217-0	CM348-60217-0M	361-64114-0	SOL5313-118-09 628
332-00024-0	PAF8-05020105	348-60217-0	TEN01252	362-64101-0	SOL5111-093-09 628
332-60005-2	REC90340-08002	348-64102-0	SOL5311-116-11	362-64103-0	SOL5111-093-08 628
332-60006-0	REC90430-08020	348-64102-0	SOL5313-111-11	362-64105-0	SOL5111-093-07 628
332-62101-0	PAF4-01010003	348-64103-0	SOL5311-114-12	362-64108-0	SOL5111-093-10 628
332S62102-1	REC6L8-G3118-01	348-64103-0	SOL5313-108-12	362-64211-0	REC879147T96 626
334-00024-1	REC53-16057	350-00001-0	REC779-803677	362-64215-0	REC43-803741 626
334-00061-0	REC8130461	350-00001-1	REC779-803677	369-00001-0	REC779-9615T 608-619
334-65021-0	CEF500383	350-00011-0	REC39-803678A1	369-00021-0	REC41-16056 608-619
336-00040-1	REC629-813047T01	350-00021-0	REC41-803680002	369-00043-0	REC31-813048 608
338-00042-0	REC31-8036752	350-00024-1	PAF15-07020005	369-00061-0	REC813046002 608
338-60218-2	CM33860-2181	350-00024-1	REC53-16057	608-609-610-619-620	REC26-16051 608
338-60218-2	TEN01250	350-00040-0	REC629-803674	369-00132-0	PAF8-05000024 613
344-67177-0	PAGB/T7940.1-M6	350-00042-0	REC31-16052	369-01215-0	REC26-16703 618
345-00042-0	REC345-00042-0	350-00061-0	REC803673	369-02230-0	PAF4-05000300 595
345-00113-0	REC30-16049T01	350-00121-0	REC26-803667	369-03231-0	REC16253 597
345-62441-0	PAF8-01000100	350-01005-0	REC350-01005-0	369-03302-0	REC27-16274 596
345-65015-0	PAF8-04040002	350-01215-5	REC8M0065585	369-03303-0	REC16275 596
345-65021-0	CEF500382	350-01303-0	REC346-01303-0	369-03306-0	REC16325 596
345-65021-0	REC345-65021-0	350-01303-0	REC350-01303-0	369-03307-0	REC27-16326 596
345-65021-1	CEF500379	350-04005-0	REC8537312	369-06021-0	REC369-06021-0 598
345-87122-0	REC84419M	350-06401-0	REC43-803739	369-60111-0	PAF8-04040004 623
345-87122-4	REC696-W0093-00	350-06401-0	REC43-803740	369-60218-1	TEN01251 607
346-00001-1	REC779-879194T01	350-61012-1	REC350-61012-1	369-60223-0	REC26-16162 618
346-00011-0	REC39-16054A5	350-62121-1	PAF8-01010200	369-62122-2	PAF8-01010200 625
346-00011-0	REC8M0080349	350-62415-0	PAJASOF40435-022	369-62439-1	PAF8-01010105 625
346-01005-0	REC346-01005-0	350-62417-0	PAF8-01000002	369-64010-2	REC43-812944 626
346-01032-0	PAF8-05010005	350-62423-0	PAF8-01000001	369-64014-0	PAF8-04000012-1 623
346-01215-0	REC26-8537072	350-64301-0	REC45-803738	369-64015-0	PAF8-04000012-2 623
346-02230-0	PAF4-05000300	350-64302-0	REC45-8037381	369-64030-2	REC43-8129451 626
346-60111-0	REC26-161301	350-65011-1	REC803751	369-64032-0	PAF8-04000012 623
346-62421-1	PAF8-01010102	350-76010-0	PH130-0061	369-64121-0	PAF15-06000016 623
346-64101-5	SOL5211-099-09	351-00001-1	REC779-803677T02	369-64211-1	REC44-195133 626

R.O. / OEM	REF		R.O. / OEM	REF		R.O. / OEM	REF	
369-64223-0	PAF8-04000305	623	3B7-65021-2	REC3B7-65021-2	604	3R3R76150M	REC5GH-13440-00	589-596
369-64301-0	REC45-161351	626	3B7-87121-7	REC3B7-87121-1	617	3T5-06920-0	PAF8-05000011	613
369-64301-0	REC8M0076368	626	3C7-60218-2	TEN01254	607	3T5-10131-0	PAF4-04000019	615
369-65011-0	REC16157	605	3C7-64536-0	SOL3411-135-15	628	3T5-87121-6	REC3T5-87121-6	617
369-65021-1	CEF500377	589-604	3C7-64536-0	SOL3413-130-15	628	3T9-01005-0	REC3T9-01005-0	617
369-65025-0	REC16159	605	3C7-64536-0	SOL3431-135-15	628	3T9-01032-0	REC3T9-01032-0	604
369-66112-1	PAF8-01010104	625	3C7-64541-0	SOL3411-133-17	628	3T9-02104-0	REC3T9-02104-0	621
369-84398-0	PAF8-05000025	615	3C7-64541-0	SOL3413-128-17	628	3V1-00001-0	PAF8-05020101	615-620
369-87122-1	REC6G1-W0093-00	597	3C7-64541-0	SOL3431-133-17	628	3V1-00011-0	REC39-8M0055809	615
393-62437-0	PAF8-01010103	625	3C7-64554-0	SOL3411-130-19	628	3V1-00030-1	PAF8-05020001	615
394-702500M	GS31015	592	3C7-64554-0	SOL3413-125-19	628	3V1-00040-0	PAF8-05020200	615-620
398-62103-0	PAF4-01010002	625	3C7-64554-0	SOL3431-130-19	628	3V1-00121-0	PAF8-05010012	615
3A0-06040-1	REC3A0-06040-1	599	3C7-65021-1	CEF500388	604	3V1-01024-0	PAF8-05000002	615
3A0-76079-0	PAF8-05000006	613	3C7760-2181	CM3C760-2181	606	3V1-01303-0	PAF8-00000004	615
3A106-2402M	REC3A106-2602M	601	3C7760-2181	CM3C760-2181A	606	3V1-02010-1	PAF8-05000008	615
3A106-2601M	REC3A106-2602M	601	3C8-00001-3	REC779-96152	620	3V1-02011-0	PAF15-07000017	615
3A106-2602M	REC3A106-2602M	601	3C8-00001-3	REC779-9615T	612	3V1-02104-0	PAF8-05000009	615
3AA-05004-0	PAF8-05050004	616	3C8-00021-0	REC41-16056	612	3V1-02305-0	PAF8-05000100	615
3AA-05013-0	PAF8-05050018	616	3C8-00021-0	REC41-803680003	611-620	3V1-02305-0	PAF8-05010004	615
3AA-05019-0	PAF4-04130101	616	3C8-00113-0	REC31-855553	612	3V1-03952-0	PAF15-07000018	615
3AA-06021-0	PAF8-05000300	598-613	3C8-01005-4	REC3C8-01005-4	617	3V1-05104-1	PAF8-05050005	616
3AA-06060-0	PAF8-05000400	613	3C8-01024-0	REC3C8-01024-0	617	3V1-05259-0	PAF8-05050002	616
3AA-06060-00	PAF8-05000400	601	3C8-01303-4	REC3C8-01303-4	618	3V1-06023-0	PAF8-05090000W	599
3AA060600M	PAF8-05000400	601	3C8-02104-0	REC3C8-02104-0	621	3V1-06040-0	PAF8-05000500	599-613
3AA-06091-0	PAF8-05000600	613	3C8-02305-0	REC3C8-02305-0	621	3V1060400	PAF8-05000500	599
3AA-07203-0	PAF8-05030005	615	3C8-03125-0	REC162532	597	3V1060400M	PAF8-05000500	599
3AA-07225-0	PAF8-05030009	615	3C8-04028-0	REC27-8555691	596	3V1-06071-0	PAF8-05000200	599-613
3AA760100	PH130-0061	600	3C8-60217-1	CM3C8-60217-0	606	3V1-06302-0	PAF8-05000013	616
3AC-02230-0	PAF15-07080000	594	3C8-60217-1	TEN01253	589-607	3V1-06308-0	PAF8-05000012	616
3AD-02230-0	PAF15-07080000	594	3C8-62104-1	PAF4-01010005	625	3V1-07010-0	PAF8-05030008	615
3B1-66145-0	PAF8-03010007	623	3C8-66116-0	PAF8-03010006	623	3V1-07201-0	PAF8-05030001	615
3B2-00001-0	REC779-804886	609-619	3C8-76010-1	PH130-0006	600	3V1-07202-0	PAF8-05030002	615
3B2-00011-0	REC39-803678A3	609-619	3C8760101	PH130-0006	600	3V1-07205-0	PAF8-05030004	615
3B2-00021-0	REC41-8036801	609-619	3C8760101M	PH130-0006	600	3V1-07221-0	PAF8-05030006	615
3B2-00040-0	REC629-8036741	609-619	3E3-64528-0	SOL5311-111-13	628	3V1-07235-0	PAF8-05030200	615
3B2-00051-0	REC26-85370711	609	3E3-64528-0	SOL5313-105-13	628	3V1-07407-0	PAF8-05010009	615
3B2-01005-0	REC3B2-01005-0	617	3E3-64536-0	SOL5311-110-15	628	3V1-07410-0	PAF8-05000800	615
3B2-01215-0	PAF8-02000002	625	3E3-64536-0	SOL5311-111-14	628	3V1-07421-0	PAF8-00000200	615
3B2-01303-0	REC3B2-01303-0	618	3E3-64536-0	SOL5313-105-14	628	3V1-07440-0	PAF8-02000003	625
3B2-63600-1	REC804898	603	3F0-06060-0	REC3F0-06060-0	601	3V1-07600-0	PAF8-05030300	615
3B2-64010-0	PAF8-04010000	623-626	3F0-65029-6	REC3F0-65029-6	605	3V1-07653-0	PAF8-05030012	615
3B2-64020-0	PAF8-04000003	623-626	3F0-87122-2	REC6A1-W0093-01	597	3V1-10045-0	PAF8-05000004	589-615
3B2-64023-0	PAF8-04000004-1	623	3F3-01005-0	REC3F3-01005-0	617	3V1-10060-0	PAF8-05010014	615
3B2-64030-0	PAF8-04000014	623-626	3F3-01024-0	REC3F3-01024-0	617	3V1-10063-0	PAF8-05010015	615
3B2-64215-0	PAF8-04000303	623-626	3F3-01303-1	REC3F3-01303-1	618	3V1-10068-0	PAF8-05010016	615
3B2-64230-1	PAF8-04000019	623	3F3-02104-0	REC3F3-02104-0	621	3V1-60041-0	PAF8-04000016	623
3B2-64513-0	SOL5011-085-07	628	3F3-02305-1	REC3F3-02305-1	604	3V1-60042-0	PAF8-04000015	623
3B2-64515-0	SOL5011-085-08	628	3F3-87122-1	REC6H4-W0093-03	597	3V1-60211-0	PANSKFJ-1516	623
3B2-64517-0	SOL5011-085-09	628	3G2-06040-2	REC3G2-06040-2	599	3V1-61208-0	PAF8-02000005	625
3B2-65011-0	PAF8-04000010	605-623	3G2-06060-2	REC3G2-06060-2	601	3V1-61220-0	PAF8-02000004	625
3B2-65016-0	PAF8-04000009	623	3G2-87122-2	REC6L2-W0093-00	597	3V1-61301-1	PAF8-02000100	625
3B2-65016-0	PAF8-04000013	623	3G3-06021-1	REC3G3-06021-1	598	3V1-61302-0	PAF8-00000002	625
3B2-65018-0	PAF8-04000008	623	3H6-07223-0	PAF8-05030007	615	3V1-61313-0	PAF8-01000003	625
3B2-65020-0	PAF8-04000005	623	3H6-07611-0	PAF15-07010100	598-613	3V1-61324-0	PAGB/T889.1-M8	625
3B2-65021-1	CEF500344	589-604	3H6-07612-0	PAF15-07010101	613	3V1-61333-1	PAF8-00000100	625
3B2-65021-1	PAF8-04000200	623	3H6-60218-0	CM3H6-60218-000	606	3V1-63508-0	PAF8-05000020	623
3B2-65021-1	REC3B2-65021-1	604	3H6-60218-0	CM3H6-60218-000A	606	3V1-63622-0	PAF8-05000019	623
3B2-65022-0	PAF8-04000021	623	3H6-60218-0	TEN01259	589-607	3V1-64211-0	PAF8-04000301	623-626
3B2-65025-0	PAF8-04000007	605-623	3H8-02093-0	PAF8-05010002	615	3V1-64221-0	PAF8-04000302	623
3B2-65029-0	PAF8-04000006	623	3H8-07025-0	PAF8-05030011	615	3V1-64306-1	PAF8-04020001S	623-626
3B2-66113-0	PAF8-03010005	623	3H8-07226-0	PAF8-005030010	615	3V1-64307-1	PAF8-04020001L	623-626
3B2-66315-0	PAF8-01010109	625	3H8-07237-0	PAF15-07040304	615	3V1-65100-0	PAF8-02000006(S)	625
3B2-66321-1	PAF8-01010108	625	3H8-10062-2	PAF8-05030400	615	3V1-65110-0	PAF8-02000006(L)	625
3B2-702501M	GS31088	591	3H8-640100	REC43-803739T03	626	3V1-65203-0	PAF8-02000009	625
3B2-702601M	GS31018	592	3H8-64020-0	REC43-803740T02	626	3V1-65206-0	PAF8-02000007	625
3B2-702801M	GS31016	592	3H8-64030-0	REC43-803741T03	626	3V1-66187-0	PAF8-03010001	623
3B2-87122-0	REC6G1-W0093-00	597	3K9-05223-0	PAF8-01010112	625	3V1-66211-0	PAF8-03000010	623
3B2S60100-0	PAF8-04040000	623	3M2-60218-0	CM3M2-60218-1	606	3V1-66225-0	PAF8-03010003	623
3B2S60101-0	PAF8-04040001	623	3M2-60218-0	TEN01257	607	3V1-66302-0	PAF8-03000011	623
3B2W64517-0	PAF8-04050000	623	3R0-07238-0	PAF15-07040303	615	3V1-66313-0	PAF8-01010106	625
3B7-02230-0	PAF15-07080000	594	3R0-66308-0	PAF8-05000021	613	3V1-87122-0	REC66M-W0093-01	597
3B7-06305-0	PAF8-05000007	613	3R1-05003-1	PAF8-05050006	616	3V1602170	CM3V1-60217-0A	606
3B7-60217-0	CM3B7-602170	606	3R1-05007-0	PAF8-05050009	616	3V1602170	CM3V1-60217-0A	606
3B7-60217-0	TEN01255	607	3R1-05012-0	PAF8-05050007	616	3V1B01001-0	PAF8-05030100	615
3B7-60217-0	TEN01260	589-607	3R1-05125-0	PAF8-05050003	616	3V1B01100-0	PAF8-05010000	615
3B7-60218-1	CM3B7-60218-0	606	3R1-05131-0	PAF4-04130102	616	3V2-03100-2	PAF8-05040000	596
3B7-60218-1	TEN01256	589-607	3R3-01030-0	REC855676002	589-603	3Y7-02234-0	REC35-802893Q01	592
3B7-64523-1	SOL3411-140-11	628	3R3-07227-0	PAF8-05030015	615	5GH-13440-00	REC5GH-13440-00	596
3B7-64527-1	SOL3411-138-13	628	3R3-07405-1	PAF15-04000002	625	5338602182A0	CM5338602182A0	606
3B7-64527-1	SOL3413-133-13	628	3R3-07406-0	PAF15-04000003	625	5338602182A0	CM5338602182A0A	606
3B7-65021-2	CEF500388	604	3R3-61017-0	PAF8-00000003	615	5338602182A0	TEN01258	589-607



R.O. / OEM	REF	
646-24251-02	REC35-80365M	595
910113-0830	PAGB/T5783-M8X30	625
910184-5620	PAGB/T5783-M6X20	625
910184-5620	PAGB/T97.1-6	625
940113-0800	PAF8-02000100	625
940121-1200	PAT15-04000011	613
945303-0500	PAGB/T896-5	625
9603-3-6204	REC30-16049	608-609
9643-3-6004	REC30-898101936	619
96603-3-6305	REC30-160494	610
9701-1-1005	NGKB7HS-10	600
9701-1-1006	NGKB8HS-10	600
9701-1-1010	NGKBP7HS-10	600
9701-1-1013	NGKBPR6HS-10	600
9701-1-1014	NGKBPR7HS-10	600
9701-1-1015	NGKBR7HS-10	600
9701-1-1103	NGKDCPR6E	589-600
9701-1-1110	NGKBR8HS-10	600
9701-1-1111	NGKIZFR6	600
9701-1-1121	NGKIKR6G8	600
9791-1-1109	NGKIZFR5J	600
98AB-5-0330	PAF8-05000024	615
98AH10-0120	PAF8-05000017	615
990A0-01E81-01Q	REC80W90U3	595
990A0-01E81-01Q	REC80W90U6	595
990C0-10W40-GLN	REC10W40U3	595
990C0-10W40-GLN	REC10W40U6	595
99998-OMA2	GS31019	591
HPLM-15400-PE	REC15400-PLM-A01PE	596
HPNB-37510-003	REC37510-PNB-003	598
HZV4-12155-A00	TEN01408	607
HZV4-30580-013	REC30580-ZV4-013	599
HZV5-12155-000	TEN01408/1	607
HZV5-19210-003	CEF500338	604
HZV5-19210-003	REC19210-ZV5-003	604
HZV5-19300-043	REC19300-ZV5-043	603
HZW1-19210-B04	CEF500337	604
HZW1-19210-B04	REC19210-ZW1-B02	604
HZW9-19300-003	PAF15-07000031	603
HZY3-06192-000	REC06192-ZY3-000	605
HZY3-16911-010	REC16911-ZY3-010	595
HZY3-19210-003	CEF500391	604
HZY3-19210-003	REC19210-ZY3-003	604
HZY3-31200-003	PH130-0070	601
HZY6-06192-000	REC06192-ZY6-000	605
HZY6-17109-000	REC17109-ZY6-000	621
HZY6-31200-003	REC31200-ZY6-003	601
HZY6-35668-003	REC35668-ZY6-003	598
HZZ3-31909-003	NGKLMAR6C-9	600
HZZ5-16911-003	REC16911-ZZ5-003	595