

OMC

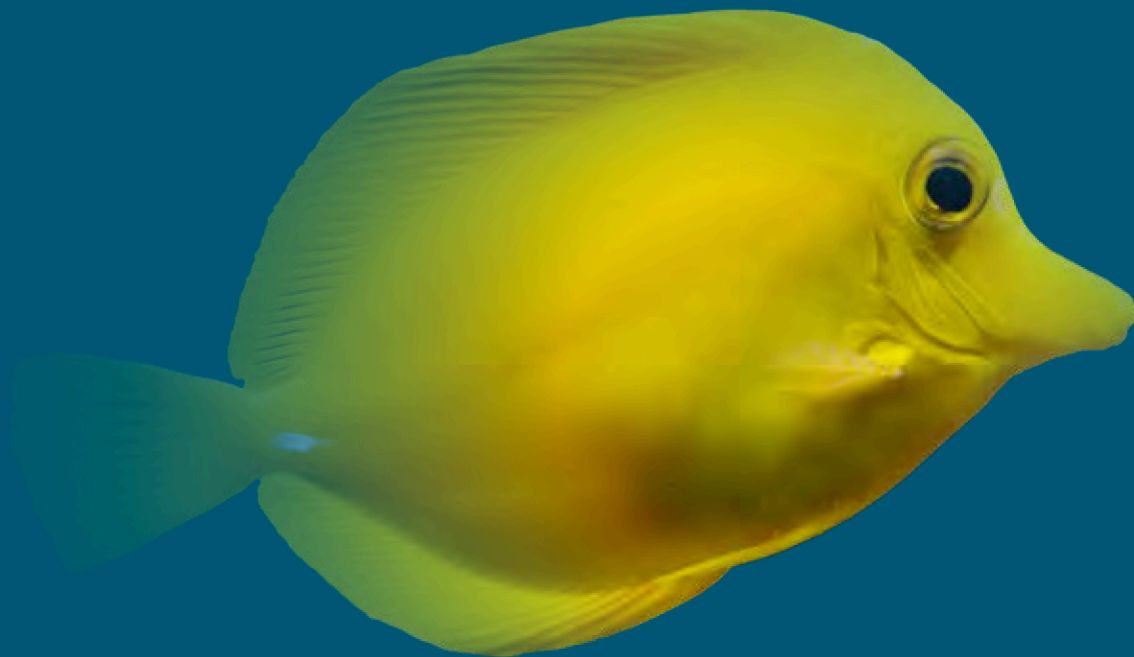





























INTRA-FUERABORDA • OUT-INBOARD
ENTRO-FUORIBORDO • IN-BORD HORS-BORD

2023
2024



ICONOS ICONS ICONE ICONES

	Medida	Measures	Dimensione	Dimension
	Ancho	Width	Larghezza	Largeur
	Alto	High	Alto	Hauteur
	Largo Fondo	Length Depth	Lungo Sfondo	Longueur Profondeur
	Unidades x bolsa	Units x bag	Unità x borsa	Unité x sachet
	Unidades x skinpack	Units x skinpack	Unità x skinpack	Unité x blister
	Caja	Box	Scatola	Carton
	Peso	Weighth	Peso	Poids
	Trabajo seguro	Safe work	Lavoro sicuro	Travailler en sécurité
	Tubo Manguera	Tube	Tubo	Tuyau Durite
	Distancia entre tornillos	Screw space	Distanza tra le viti	Entraxe
	Tornillo	Screw	Vite	Vis
	Rosca	Thread	Filo	Filetage
	Rosca Macho	Male Thread	Filetto maschio	Filetage mâle
	Rosca Hembra	Female thread	Filetto femmina	Filetage femelle
	Electricidad	Power	Elettricità	Electricité
	Eslora	Boat length	Lunghezza imbarcazione	Longueur embarcation
	Mando	Control	Comando	Boitier
	Carga máxima	Max. Load	Caricca massima	Charge maximale
	Flujo Velocidad	Flow Speed	Flow	Vitesse du débit
	Presión	Pressure	Presione	Pression
	Presión máx.	Max. pressure	Presione mass.	Pression max.
	Radio	Radius	Raggio	Rayon
	Entrada	IN	Ingresso	Entrée
	Salida	OUT	Uscita	Sortie
	Capacidad	Capacity	Capacità	Capacité
	Temperatura	Temperature	Temperatura	Température
	Hélice	Propeller	Elica	Hélice
	Cono eje	Hub	Asse conico	Asse conique
	Motor	Motor	Motore	Moteur

	Ánodo	Anode	Anodo	Anode
	Filtro	Filter	Filtro	Filtre
	Elemento filtro	Filter Element	Elemento filtro	Cartouche de filtre
	Llave	Key	Chiave	Clé
	Posiciones llave	Key positions	Chiave, posizione	Clé, positions
	Material	Material	Materiale	Matériel
	Pins	Pins	Pin	Pines
	Cables Terminales	Terminals	Terminali	Bornes
	Junta	Gasket	Guarnizione	Joint
	Piston	Piston	Pistone	Piston
	Aros de piston	Piston ring	Fasce pistone	Segments de piston
	Cojinete	Bearing	Cuscinetto	Roulement
	Impulsor	Impeller	Girante	Turbine
	Tuerca	Nut	Dado	Écrou
	Dientes	Tooth	Denti	Dents
	Estrías	Spline	Scanalatura	Dents
	Polea	Pulley	Pulleggia	Poulie
	Solenide Relé	Solenoid Relay	Relé	Relais
	Conector latiguillo	Trim connectors	Connettori trim	Connecteurs flexible de trim
	Fuelle	Bellow	Cuffia	Soufflet
	Abrazadera	Clamp	Fascetta	Collier
	Cuerpos carburador	Carburetors BBL	Corpi carburatore	Cors carburateur
	Volante	Flywheel	Volante	Volant
	Flotador	Float	Galleggiante	Floteur
	Kit aguja carburador	Inlet needle kit	Kit spillo	Kit pointeau
	Cable	Wire	Cavi	Faisceau
	Centrador bomba aspiración agua	Water pump cross pieces	Centratori pompa aspirazione	Toc d'entrainement de pompe à eau
	Consola bomba agua	Pump console	Tirante per pompa	Support de pompe à eau
	Tope bomba agua	Pump stop	Aletta arresto pompa	Butée de pompe à eau
	PROHIBIDO. No recomendado.	PROHIBITED. Not recommended.	VIETATO. Non è raccomandato.	INTERDIT. Déconseillé.

SISTEMA ALIMENTACIÓN Y FILTRACIÓN	619
ACCESORIOS PARA FILTROS	623
BOMBA DE COMBUSTIBLE	624
BOMBA DE COMBUSTIBLE ELÉCTRICA	624
BOMBA DE COMBUSTIBLE MECÁNICA	624
CARBURADOR	624
BOYAS	628
CARBURADOR- KITS	626
GUÍA KITS DE CARBURADORES	629
JUNTA BASE	625
FILTRO DE ACEITE	621
FILTRO DE COMBUSTIBLE Y ELEMENTOS	619
BRACKET	619
FILTRO COMBUSTIBLE - SEPARADOR AGUA	619
FILTRO DECANTADOR	619
FILTRO GASOLINA	621
RACOR DE LATÓN	620
MANGUERA CARBURANTE	622
RACORES	622
SISTEMA ELÉCTRICO	630
ALTERNADORES	633
MOTORES DE ARRANQUE	631
REGULADORES	632
SENSORES	630
SENSOR MAP	630
SENSOR PRESIÓN DE ACEITE	630
SENSOR TEMPERATURA DEL AGUA	630
SENSOR TEMPERATURA DEL AIRE	630
SENSOR TPS	630
SOLENOIDE RELÉ	633
SOLENOIDE	633
RELÉ BOMBA GASOLINA ELÉCTRICA	633
TRIM	634
TRIM - LATIGUILLOS	635
TRIM - MOTOR	634
TRIM - SENSOR	635
SISTEMA DE REFRIGERACIÓN	636
BOMBA ASPIRACIÓN DE AGUA	637
TERMOSTATO	636
GUÍA	636
TERMOSTATO	636
TERMOSTATO - CUERPO	637
PARTES DEL MOTOR	644
JUNTAS PARA BASES GM Y FORD	644
SISTEMA ENCENDIDO	638
BOBINAS	638
GUÍA	638
BUJÍAS	639
BUJÍAS	639
CABLES ALTO RENDIMIENTO	639
DISTRIBUIDOR	640
CONDENSADORES	641
KITS ENCENDIDO	642
KITS ENCENDIDO ELECTRÓNICO	643
PLATINOS	642
ROTORES	642
TAPA	640
TAPA - ENCENDIDO ELECTRÓNICO	641
MÓDULO IGNICIÓN	640
MÓDULO SISTEMA CAMBIO	643
SISTEMA ESCAPE Y ADMISIÓN	661
BOMBA DE CIRCULACIÓN	671
BOMBAS	671
MANGUITO	671
COLECTORES Y CODOS ESCAPE	669
JUNTAS	669
JUNTAS COLECTOR ADMISIÓN	670
JUNTAS CODOS	670
JUNTAS TAPA	670
TAPON GOMA	670
TAPA	670
DESPIECES COLECTORES Y CODOS	661
120 HP, 4 CYL 153 CID	661
2.5 GM SERIES 400	661

120HP, 4 CYL 153 CID	662
2.5L GM (1981-86)	663
140HP, 4 CYL 181 CID	663
3.0L GM (1973-90)	664
4.3 H.O. GM 262 CID V6 (1986-90)	664
4.3 GM 262 CID V6 (1991+)	665
800 GM 305 / 350 CID V8	666
5.7L GM 350 CID V8 (1990+)	667
5.0 / 5.8L & EFI FORD 302/351 CID V8 (1991+)	667
7.4 / 8.2L GM 454/502 CID V8 (1991+)	668
UNIDADES DE TRANSMISIÓN	672
ÁNODOS	672
COMPONENTES DE COLA	693
ACOPLAMIENTOS	693
CABLE CAMBIO	694
CABLE CAMBIO ELÉCTRICO	694
CRUCETAS DEL CARDAN	695
EJE HÉLICE, CAMBIO MECÁNICO	695
EJES TRANSMISIÓN	694
FUELLES CABLE DE CAMBIO	693
FUELLES ESCAPE	693
FUELLES TRANSOM	693
KIT ENGRANAJES TRANSOM	694
KIT PIÑONES Y DESPLAZABLES	694
CORREAS	691
DESPIECE COLAS	674
COBRA (1986-93)	674
COBRA (1994-98)	680
400-800 (1973-85)	682
DESPIECE TRANSOM	686
ANTIGUO	687
COBRA (1986-93)	686
HERRAMIENTAS DE COLA	695
ALINACIÓN DE MOTOR	695
KITS REPARACIÓN	688
400-800	688
COLAS	688
EJE BOMBA	689
GOMAS	688
JUNTAS	689
KIT TRANSOM	688
KIT BOMBA	689
RETENES	690
GUÍA AROS TÓRICOS	690
GUÍA RETENES ACEITE	690
GUÍA RETENES COBRA	691
UNIDADES DE TRANSMISIÓN	673
KIT CONVERSIÓN OMC-COBRA	673
PARTE INFERIOR COMPLETA	673
SISTEMA DE PROPULSIÓN	696
HÉLICES AL E INOX DE 3 Y 4 PALAS	696
GUÍA HÉLICES CON NÚCLEO INTEGRADO	697
HÉLICES PARA NÚCLEO INTERCAMBIABLE	697
NÚCLEO INTERCAMBIABLE	697
PIEZAS DE HÉLICE	698
ESPACIADOR	698
KIT CIERRE HÉLICE	699
PASADOR	698
TOPE HÉLICE	698
TUERCA HÉLICE	699
REF --> RO	700
RO --> REF	704

FUEL & FILTRATION SYSTEM	619
CARBURETOR	624
BASE GASKETS	625
CARBURETORS: GUIDE	628
CARBURETORS: KIT	626
FLAME ARRESTORS	628
FLOAT	628
GUIDE: GASKET KITS	629
FILTER ACCESSORIES	623
FUEL FILTERS AND ELEMENTS	619
BRACKET	619
BRASS RACCORS	620
COMPLETE FUEL FILTER	619
FUEL FILTER	621
WATER SEPARATING FUEL FILTER	619
FUEL HOSES	622
FUEL PUMP	624
ELECTRICAL	624
MECHANICAL	624
OIL FILTER	621
RACOR	622
ELECTRIC SYSTEM	630
ALTERNATORS	633
REGULATOR	632
SENSORS	630
AIR TEMPERATURE	630
MAP	630
OIL PRESSURE	630
TPS	630
WATER TEMPERATURE	630
SOLENOID & RELAY	633
RELAY FUEL ELECTRIC PUMP	633
SOLENOID	633
STARTERS	631
TRIM	634
HOSES	635
SENSOR	635
TRIM ENGINE	634
IGNITION SYSTEM	638
DISTRIBUTOR	640
CAP	640
CONDENSERS	641
DISTRIBUTOR	640
ELECTRONIC CONVERSION KITS	643
POINTS	642
ROTORES	642
TUNE UP KITS	642
IGNITION COIL	638
GUIDE	638
IGNITION MODULES	640
SPARK PLUG	639
HD SPARK PLUG WIRES SET	639
SHIFT ASSIT MODULE	643
COOLING SYSTEM	636
THERMOSTAT	636
THERMOSTAT GUIDE	636
THERMOSTAT KITS	636
WATER PUMPS	637
RAW WATER PUMP	637
ENGINE PARTS	644
MARINE GASKETS TO GM & FORD ENGINES	644
EXHAUST & INTAKE SYSTEM	661
BLOCK CIRCULATING PUMP	671
HOSE	671
PUMPS	671
MANIFOLDS & ELBOWS	669
COVER	670
COVER GASKET	670
ELBOW GASKET	670
EXHAUST ELBOWS	669
EXHAUST MANIFOLD	669
EXHAUST MANIFOLD GASKET	669
GASKETS	669
INTAKE MANIFOLD GASKET	670
RUBBER CAP	670

MANIFOLDS & ELBOWS PARTS	661	GEAR HOUSING COMPONENTS	693	TRANSOM PARTS	686
120 HP, 4 CYL 153 CID	661	BALL GEAR KIT TRANSOM	694	COBRA (1986-93)	686
2.5 GM SERIES 400	661	COUPLERS	693	INTERMEDIATE HOUSING-STRINGER MOUNT	687
120HP, 4 CYL 153 CID	662	DRIVES SHAFTS	694	UNIT DRIVES	673
2.5L GM (1981-86)	662	ELECTRIC SHIFT CABLE	694	CONVERSION KIT OMC-COBRA	673
140HP, 4 CYL 181 CID	663	EXHAUST BELLOWS	693	COMPLETE GEAR HOUSING ASSEMBLY	673
3.0L GM (1973-90)	663	GEAR SETS & CUTCH	694	V-BELTS GUIDE	691
4.3 H.O. GM 262 CID V6 (1986-90)	664	PROP SHAFT MECHANICAL SHIFT	695	PROPULSION SYSTEM	696
4.3 GM 262 CID V6 (1991+)	664	SHIFT CABLE	694	3 & 4 BLADE AL & SS PROPELLERS	696
800 GM 305 / 350 CID V8	665	SHIFT CABLE BELLOWS	693	PROPELLERS APPLICATION WITH RUBBER HUB	697
5.7L GM 350 CID V8 (1990+)	666	TRANSOM BELLOWS	693	PROPELLERS SOLAS APPLICATION GUIDE	698
5.0 / 5.8L & EFI FORD 302/351 CID V8 (1991+)	667	U-JOINTS	695	PROP HARDWARE	698
7.4 / 8.2L GM 454/502 CID V8 (1991+)	668	REPAIR KITS	688	COTTER PIN	698
TRANSMISSION UNIT	672	400-800	688	KITS	699
ANODE	672	DRIVES	688	NUT	699
GASKETS	689	PLATE SEAL	688	SPACER	698
DIPSTICK	689	TRANSOM	688	THRUST WASHER	698
OUTDRIVE SEAL COBRA	689	WATER PUMP SHAFT	689	REF --> OEM	700
WATER OUTLET	689	WATER PUMP AGUA	689	OEM --> REF	704
SWIVEL BRG. MECH SHIFT	689	SEALS	690		
SWIVEL BRG. ELECT. SHIFT	689	COBRA SELAS APPLICATIONS	691		
GEAR CASE PARTS	674	O-RING GUIDE	690		
COBRA (1986-93)	674	OIL SEAL GUIDE	690		
COBRA (1994-98)	680	TOOLS	695		
400-800 (1973-85)	682	ENGINE ALIGNMENT TOOL	695		

IT

SISTEMA DI ALIMENTAZIONE E FILTRAZIONE	619	TRIM	634	GUARNIZIONE POMPA	
ACCESSORI PER FILTRI	623	MOTORI	634	GUIDA POMPA ACQUA	
CARBURATORE	624	TUBI TRIM COBRA	635	GUIDA POMPA E TENUTE	
GALLEGGIANTE	628	SENSORE COBRA	635	KIT RICAMBI	
GUARNIZIONE BASE	625	SISTEMA DI ACCENSIONE	638	PIASTRA POMPA	
GUIDA	628	BOBINE	638	TERMOSTATO	636
GUIDA KIT	629	GUIDA	638	KITS	636
KIT	626	CANDELE	639	GUIDA	636
FILTRO ARIA		KIT CAVI CANDELE, ALTE PRESTAZIONI	639	CORPO	637
FILTRI BENZINA E RACCORDI	619	MODULI AVVIAMENTO	640	PARTI MOTORE	644
FILTRO BENZINA	621	MODULO SISTEMA CAMBIO	643	GUARNIZIONI PER MOTORI GM E FORD	644
FILTRO DI DECANTEZIONE BENZINA	619	SPINTEROGENO	640	SISTEMA DI SCARICO E ASPIRAZIONE	661
FILTRO SEPARATORE ACQUA-BENZINA	619	CALOTTE	640	COLLETORE SCARICO	669
RACCORDO IN OTTONE	620	CONDENSATORI	641	GOMITI	669
SUPPORTO	619	ROTORI	642	GUARNIZIONE COLLETORE DI SCARICO	669
FILTRO OLIO	621	PUNTINE	642	GUARNIZIONE COLLETORE ASPIRAZIONE	670
POMPA BENZINA	624	KIT	642	GUARNIZIONE COPERCHIO	670
POMPA BENZINA ELETTRICA	624	KIT DI CONVERSIONE ELETTRICO	643	TAPPO IN GOMMA	670
POMPA BENZINA MECCANICA	624	SISTEMA DI RAFFREDDAMENTO	636	COPERCHIO	670
RACCORDI	622	ANODI		PARTI COLLETTORI E GOMITI	661
TUBO DI CARBURANTE	622	CANADA METAL		120 HP, 4 CYL 153 CID	
SISTEMA ELETTRICO	630	RECMAR		2.5 GM SERIES 400	661
ALTERNATORE	633	TECNOSEAL		120HP, 4 CYL 153 CID	
MOTORINI AVVIAMENTO	631	GUIDA GIRANTE		2.5L GM (1981-86)	662
REGOLATORI	632	KIT TENUTE		140HP, 4 CYL 181 CID	
SENSORE	630	GUIDA KIT TENUTE		3.0L GM (1973-90)	663
SENSORE MAP	630	GUIDA TENUTE		4.3 H.O. GM 262 CID V6 (1986-90)	
SENSORE TPS	630	LIQUIDO INIBITORE DELLA CORROSIONE		4.3 GM 262 CID V6 (1991+)	664
SENSORE PRESSIONE DELL'OLIO	630	POMPA ACQUA	637	800 GM 305 / 350 CID V8	665
SENSORE TEMPERATURA ACQUA	630	BASE		5.7L GM 350 CID V8 (1990+)	666
SENSORE TEMPERATURA ARIA	630	BASE - KIT		5.0 / 5.8L & EFI FORD 302/351 CID V8 (1991+)	667
SOLENOIDI E RELE	633	BOCCOLA		7.4 / 8.2L GM 454/502 CID V8 (1991+)	668
SOLENOIDI	633	CORPO			
RELE POMPA BENZINA ELETTRICA	633	CORPO - KIT			

POMPA DI RICIRCOLO DI BLOCCO	671
POMPE	671
MANICOTTO	671

UNITÀ DI TRASMISSIONE 672

ANODI	672
ATTREZZATURA	695
ALLINEAMENTO MOTORE	695
COMPONENTI PIEDE	693
ASSE ELICA CAMBIO MECCANICO	695
ASSE TRASMISSIONE	694
CAVO CAMBIO	694
CAVO CAMBIO ELETTRICO	694
CROCIERA	695
CUFFIE CAMBIO	693
CUFFIE SCARICO	693
CUFFIE TRANSON	693
KIT ENGRANAGGIO TRANSON	694
KIT PIGNONI	694
PARASTRAPPI	693
GUIDA CINGHIE	691
GUARNIZIONE	689
ASTICELLA DELL'OLIO	689
CAMBIO ELETTRONICO	689
CAMBIO MECCANICO	689
CHIUSURA COBRA	689
PASSAGGIO DELL'ACQUA	689
KIT RIPARAZIONE	688
400-800	688
ASSE POMPA ACQUA	689
GOMMA TRANSON	688
KIT POMPA ACQUA	689
PIEDI	688
TRANSON	688
PARAOLIO	690
APPLICAZIONI PARAOLIO COBRA	691
GUIDA PARAOLIO	690
GUIDA TENUTE	690
PARTI PIEDI	674
COBRA (1986-93)	674
COBRA (1994-98)	680
400-800 (1973-85)	682
PARTI TRANSON	686
COBRA (1986-93)	686
VECCHIO	687
UNITÀ DI TRASMISSIONE	673
KIT CONVERSIONE OMC-COBRA	673
PORTE INFERIORE COMPLETA	673

PROPULSION SYSTEM 696

CHIUSURA ELICA	698
DISTANZIALE	698
DADO	699
CHIAVISTELLI	698
FERMO	698
KIT	699
ELICHE ALLUMINIO E INOX DA 3 E 4 PALE	696
GUIDA ELICHE CON MOZZO	697
GUIDA MOZZI	697
REF --> OEM	700
OEM --> REF	704

FR

SYSTÈME D'ALIMENTATION ET DE FILTRATION 619

ACCESSOIRES POUR FILTRES	623
CARBURATEUR	624
CARBURATEUR - GUIDE DE KITS	629
CARBURATEUR - KIT	626
FLOTTEUR	628
GUIDE DES CARBURATEURS	628
JOINTS DE BASE	625
FILTRE À ESSENCE ET CARTOUCHE DE RECHANGE	619
FILTRE À ESSENCE	621
FILTRE À ESSENCE	619
FILTRE DÉCANTATEUR D'ESSENCE	619
RACCORD EN LAITON	620
TÊTE DE FILTRE	619
FILTRE À HUILE	621
POMPE À ESSENCE	624
POMPE À ESSENCE ÉLECTRIQUE	624
POMPE À ESSENCE MÉCANIQUE	624
RACCORDS	622
TUYAU DU CARBURANT	622

SYSTÈME ÉLECTRIQUE 630

ALTERNATEUR	633
CAPTEURS	630
MAP	630
TEMPERATURE DE L'AIRE	630
PRESSION D'HUILE	630
TEMPERATURE D'EAU	630
TPS	630
DÉMARREUR	631
REGULATEURS	632
SOLENOIDE RELAIS	633
SOLENOIDE	633
RELAIS POUR POMPE ÉLECTRIQUE	633
TRIM	634
CAPTEUR TRIM COBRA	635
MOTEUR DE TRIM	634
TUYAU	635

SYSTÈME D'ALLUMAGE 638

ALLUMEUR	640
CONDENSATEUR	641
DOIGT D'ALLUMEUR	642
KITS	642
KITS DE CONVERSION ÉLECTRONIQUE	643
TÊTE D'ALLUMEUR	640
VIS PLATINÉES	642
BOBINE D'ALLUMAGE	638
GUIDE	638
BOUGGIES	639
KIT FAISCEAU DE BOUGIE	639
MODULES D'ALLUMAGE	640
MODULES SYSTÈME DE CHANGEMENT	643

SYSTÈME DE REFROIDISSEMENT 636

POMPE À EAU	637
THERMOSTAT	636
CORS DE THERMOSTAT	637
GUIDE	636
THERMOSTAT	636

PIÈCES MOTEUR 644

JOINTS POUR MOTEURS GM ET FORD	644
--------------------------------	-----

SYSTÈME D'ÉCHAPPEMENT ET D'ADMISSION 661

COLLECTEUR D'ÉCHAPPEMENT	669
BOUCHON EN CAOUTCHOUC	670
COUDE D'ÉCHAPPEMENT	669
COUVERCLE	670
JOINTS COLLECTEUR D'ÉCHAPPEMENT	669
JOINTS COLLECTEUR ADMISSION	670

JOINTS COUDES	670
JOINTS COUVERCLE	670
PIÈCES COLLECTEURS ET COUDES	661
120 HP, 4 CYL 153 CID	661
2.5 GM SERIES 400	662
120HP, 4 CYL 153 CID	662
2.5L GM (1981-86)	663
140HP, 4 CYL 181 CID	663
3.0L GM (1973-90)	664
4.3 H.O. GM 262 CID V6 (1986-90)	664
4.3 GM 262 CID V6 (1991+)	665
800 GM 305 / 350 CID V8	666
5.7L GM 350 CID V8 (1990+)	667
5.0 / 5.8L & EFI FORD 302/351 CID V8 (1991+)	668
7.4 / 8.2L GM 454/502 CID V8 (1991+)	671
POMPE DE BRASSAGE	671
DURITE	671
POMPES	671

EMBASES ET PIÈCES 672

ANODES	672
COMPONENTS D'EMBASES	693
ACCOUPEMENTS	693
ARBRE HÉLICE CHANGEMENT MÉCANIQUE	695
ARBRE TRANSMISSION	694
CÂBLE CHANGEMENT	694
CARDAN	695
KIT PIGNONES	694
KIT PIGNONES TRANSON	694
SOUFFLET CABLE CHANGEMENT	693
SOUFFLET D'ÉCHAPPEMENT	693
SOUFFLET TRANSON	693
EMBASES	673
KIT CONVERSION OMC-COBRA	673
PARTIE INFÉRIEURE COMPLETE	673
GUIDE COURROIES	691
JOINTS	689
CHANGEMENT ÉLECTRONIQUE	689
CHANGEMENT MÉCANIQUE	689
FERMENTURE COBRA	689
SORTIE D'EAU	689
TIGE D'HUILE	689
JOINTS SPI	690
GUIDE JOINTS	690
GUIDE JOINTS SPI	690
GUIDE JOINTS SPI COBRA	691
KITS DE RÉPARATION	688
400-800	688
ARBRE POMPE D'EAU	689
EMBASES	688
JOINT DE TRANSON	688
KIT POMPE D'EAU	689
TRANSON	688
PIÈCES D'EMBASES	674
COBRA (1986-93)	674
COBRA (1994-98)	680
400-800 (1973-85)	682
PIÈCES TRANSON	686
ANCIEN	687
COBRA (1986-93)	686
OUTILS	695
OUTIL D'ALIGNEMENT	695

SYSTÈME DE PROPULSION 696

HÉLICE ALUMINIUM ET INOX 3 ET 4 PALES	696
GUIDE DES HÉLICES ET MOYEUX	697
MOYEU INTERCHANGEABLE	697
PIÈCES POUR HÉLICE	698
ÉCROU D'HÉLICE	699
ENTRETOISE	698
GOUPILLE FENDUE	698
KIT ÉCROU D'HÉLICE	699
RONDELLE FREIN	698
REF --> RO	700
RO --> REF	704

SISTEMA DE ALIMENTACIÓN Y FILTRACIÓN FUEL & FILTRATION SYSTEM

SISTEMA DI ALIMENTAZIONE E FILTRAZIONE SYSTÈME D'ALIMENTATION ET DE FILTRATION

FILTRO DE COMBUSTIBLE Y ELEMENTOS FUEL FILTERS AND ELEMENTS FILTRI BENZINA E RACCORDI FILTRE A ESSENCE ET CARTOUCHE DE RECHANGE

BRACKET

Con 2 tapones de bronce y 2 tubos de extensión. (2 entradas y 2 salidas).

BRACKET



With 2 brass plugs and 2 extension tubes. (2 inputs & 2 outputs).

SUPPORTO

Con 2 tappi di bronzo e 2 tubi di estensione. (2 ingressi entrata carburante e 2 uscite carburante).

TÊTE DE FILTRE À ESSENCE

Avec 2 bouchons en bronze et 2 tubes d'extension. (2 entrées et 2 sorties).

REF		
REC25000	1/4"	AL
REC25010	1/4"	INOX /SS AISI316
REC25020	3/8"	AL
REC25030	3/8"	INOX /SS AISI316
RECOBBRACKET	1/4"	Plast.



REC25000 - REC25020



REC25010 - REC25030



RECOBBRACKET

FILTRO COMBUSTIBLE SEPARADOR DE AGUA

WATER SEPARATING FUEL FILTER

FILTRO SEPARATORE ACQUA-BENZINA

FILTRE À ESSENCE

REF	OEM
REC35-8M0061975	174144 502905

RECMAR®



REF	OEM
RM3862228	987754 502906



FILTRO CON BRACKET

Con 2 tapones de bronce y 1 tubo de extensión.

OEM FILTER WITH BRACKET



With 2 brass plugs & 1 extension tube.

FILTRO BENZINA CON SUPPORTO

Con 2 tappi di bronzo e 1 tubo di estensione.

FILTRE A ESSENCE AVEC SUPPORT

avec 2 bouchons en bronze et 1 tube d'extension

REF	OEM	MICRON			BRACKET
REC24950	35-60494A4	25	1/4"	50 GPH	AL



RECMAR®

FILTRO DECANTADOR GASOLINA

Con Bracket Inox y cubeta metálica.

COMPLETE FUEL FILTER

With Stainless Steel Bracket and metallic bowl.

FILTRO DECANTATORE BENZINA

Con Bracket e vaschetta metallica.

FILTRE DÉCANTEUR POUR ESSENCE

Avec support en acier inoxydable et cuvette métallique.

REF	OEM		OEM
RAC320R-RAC-02	35-802893Q4	RACS3220UL	35-809101



**FILTRO DECANTADOR
GASOLINA**
COMPLETE FUEL FILTER
**FILTRO DECANTATORE
BENZINA**
**FILTRE DÉCANTEUR POUR
ESSENCE**
RACOR

				RAC120R-RAC-01	RAC320R-RAC-01	RAC320R-INOX-01	RAC320R-RAC-02
FLUJO MÁXIMO	MAX. FLOW	FLUSSO MASSIMO	FLUX MASSIMALE	114 l/h 30 gph	340 l/h 60 gph	340 l/h 60 gph	340 l/h 60 gph
ELEMENTO	ELEMENT	ELEMENTO	ÉLÉMENT	RACS3240	RACS3213	RACS3213	RACS3220UL
CAZOLETA TRANSPARENTE (sólo se recomienda para fueraborda.)	CLEAR BOWL (just for outboards)	VASCHETTA TRANSPARENTE (solo nei fuoribordo.)	CAZOLETA TRANSPARENTE (uniquement recommandé pour le hors-bord.)	✓ PLAST.	✓ PLAST.	✓ PLAST.	✗ METAL.
ROSCAS CENTRALES	CENTRAL THREADS	FILETTO CENTRALE	FILS CENTRAUX	M18 x 1.5	1 1/4"	1 1/4"	1 1/4"
TAMAÑO ROSCA CABEZA	HEAD PORT SIZE	DIMENSIONE VITE TESTA	TAILLE DU FIL DE TÊTE	1/4-18 NPTF	1/4-18 NPTF	1/4-18 NPTF	1/4-18 NPTF
ALTURA X Ø	HEIGHT X Ø	ALTEZZA X Ø	HAUTEUR X Ø	166 x 81 x 81 mm	238 x 102 x 102 mm	238 x 102 x 102 mm	238 x 102 x 102 mm
PESO	WEIGHT	PESO	POIDS	0,5 kg	0,9 kg	0,9 kg	0,9 kg
CAIDA DE PRESIÓN	PRESSURE DROP	CADUTA DI PRESSIONE	CHUTE DE PRESSION	0.15 PSI 0.01 bar	0.61 PSI 0.04 bar	0.61 PSI 0.04 bar	0.61 PSI 0.04 bar
PRESIÓN MÁXIMA	MAX. PRESSURE	PRESIONE MASSIMA	PRESSION MAXIMALE	7 PSI 0.05 bar	7 PSI 0.05 bar	7 PSI 0.05 bar	7 PSI 0.05 bar
DESMONTAJE CARTUCHO-CAZOLETA	ELEMENT REMOVAL UNDERBOWL	RIMOZIONE DELLA CARTUCCIA	DÉMONTAGE DE LA CARTOUCHE	25,4 mm 1"	25,4 mm 1"	25,4 mm 1"	25,4 mm 1"
TEMPERATURA DE TRABAJO	OPERATING TEMPERATURE	TEMPERATURA DI LAVORO	TEMPERATURE DE TRAVAIL	-40°C +124°C			

**ELEMENTOS DE
RECAMBIO**
ELEMENT
ELEMENTI DI RICAMBIO
CARTOUCHE DE RECHANGE

REF	OEM	
RACS3240		RAC120R-RAC-01
LENS3240		
RACS3227	35-886638	
LENS3227		
RACS3213		RAC320R-RAC-01
LENS3213	35-809097	RAC320R-RAC-01 INOX RAC320R-RAC-03
RACS3214	35-809099	
RACS3228UL		RAC320R-RAC-02, bracket RACOR

 LENS3240
LENS3227
LENS3214

 RACS3240
RACS3227
RACS3214

RACS3228UL

RÁCORES DE LATÓN
BRASS RACORS
RACCORDI IN OTTONE
RACCORDS À LAITON

REF	OEM			
GS31066	22-89771Q2	1/4" NPT	5/16" = 7.9 mm	2
GS31067		1/4" NPT	3/8" = 9.5 mm	2

GOLDENSHIP

REF			
GS31065	1/4" NPT	3/8" = 9.5 mm	1
GS31066	1/4" NPT	5/16" = 7.9 mm	2
GS31055	3/8" NPT	3/8" = 9.5 mm	2
GS31056	3/8" NPT	5/16" = 7.9 mm	2
GS31157	3/8" NPT	1/4" = 6.4 mm	2



FILTRO GASOLINA

FUEL FILTER

FILTRO BENZINA

FILTRE À ESSENCE

REF	OEM
REC35-53336	908034



REF	OEM
REC35-49088A2	312456 381690



REF	OEM
REC984491	984491



REF	OEM
REC982230	982230



REF	OEM
REC981911	981911



REF	OEM
REC1397-2150	983870



FILTRO DE ACEITE

OIL FILTER

FILTRO OLIO

FILTRE A HUILE

REF	OEM	Icon
REC35-06003	778864	4L GM



REF	OEM	Icon
REC35-06004	173834 502903	V6 GM



REF	OEM	Icon
REC35-06007	502900	2.3L, V8, 302, 351



REF	OEM	Icon
RACS3228UL	173233 502901	V8 GM



REF	OEM	Icon
REC502900	502900	2.3L, V8, 302, 351 Ford



REF	OEM	Icon
REC3517857	174796 502904	Ford 7.5L / 460





RACORS

RACORS

RACCORDI

RACCORDS

REF		
GS30430	8 mm	2
GS30431	10 mm	2

GOLDENSHIP



ORIENTABLES
GUIDEBLE
ORIENTABILE
ORIENTABLE

REF		
GS30432	8 mm	2
GS30433	10 mm	2

GOLDENSHIP



REF				
RAC1/2X16	1/2"	16 mm	1	1
RAC1/2X18	1/2"	18 mm	500	1
RAC1/2X20	1/2"	20 mm	900	1
RAC3/8X10	3/8"	10 mm	1000	1
RAC3/8X12	3/8"	12 mm	1	1
RAC3/8X14	3/8"	14 mm	1	1

RACOR



REF	NPT		
BRA125-3/16x1/4	1/4"	3/16"	1
BRA125-1/4x1/2	1/2"	1/4"	1
BRA125-5/16x3/8	3/8"	5/16"	1
BRA125-3/8x3/8	3/8"	3/8"	1
BRA125-3/8x1/2	1/2"	3/8"	1
BRA125-1/2x3/8	3/8"	1/2"	1
BRA125-1/2x1/2	1/2"	1/2"	1
BRA125-1/2x3/4	3/4"	1/2"	1
BRA125-5/8x3/8	3/8"	5/8"	1
BRA125-5/8x3/4	3/4"	5/8"	1
BRA125-3/4x3/4	3/4"	3/4"	1
BRA125-1x3/4	3/4"	1"	1
BRA125-1/4x3/8	1/4"	3/8"	1



REF	NPT	NPT		
RAC1/2F-1/2M	7/8"	1/2"	900	1
RAC3/8F-3/8M	3/4"	3/8"	1000	1
			500	1

RACOR



REF			
GS31066	1/4" NPT	5/16" = 7.9 mm	2
GS31055	3/8" NPT	3/8" = 9.5 mm	2
GS31056	3/8" NPT	5/16" = 7.9 mm	2

GOLDENSHIP



MANGUERA CARBURANTE

FUEL HOSE

TUBO DI CARBURANTE

TUYAU DU CARBURANT

Tubo de goma para el transporte de carburante (diesel o gasolina). Construida en goma negra (NBR). Contenido aromático no superior al 60%. Resistente a la abrasión de los agentes marinos.

Long length rubber hose, suitable for loading diesel, bio-diesel and unloading fuel for marine pleasure craft inboard engines up to 24 m.

Tubo in gomma per il passaggio di carburante (diesel o benzina). In gomma nera (NBR). Per motori entrobordo su imbarcazioni da diporto fino a 24m.

Tuyau en caoutchouc pour le passage du carburant (diesel ou essence). Caoutchouc noir (NBR). Pour moteurs in-bord sur bateaux de plaisance jusqu'à 24m.

CARBO/7840/A1

REF	Ø (mm)						
GS35049	6x16	14 bar	35 mm			40 m	
GS35050	8x17	14 bar	50 mm			40 m	
GS35051	10x19	14 bar	60 mm			40 m	
GS35052	12x22	10 bar	75 mm	-30°C ~ 100°C	30 bars	20 m	Rina CE 0474 Lloyd's Register 96/00/127
GS35053	16x26	10 bar	100 mm			40 m	
GS35054	19x30	10 bar	115 mm			20 m	
GS35055	25x37	10 bar	250 mm			x m	

ht
hoses technology

SAE J 1527 - 2004

USCG A1 R1

ISO 7840 A-1 2004 CE



De goma para diesel y gasolina sin plomo. Ideal para fueraborda. Refuerzos textiles internos. Muy flexible. Contenido aromático 50%.

Rubber Hose suitable for loading mineral oils, diesel and unleaded fuel

In gomma per diesel e benzina senza piombo. Ideale per motori fuoribordo. Tessuto interno rinforzato. Molto flessibile.

En caoutchouc pour diesel et essence sans plomb. Idéal pour les moteurs hors-bord. Tissu intérieur renforcé. Très flexible.

CARBUPOMP/10NL

REF	Ø (mm)				
GS35031	6x12	10 bar	50 mm	-25°C ~80° C	50 m
GS35032	8x15	10 bar	65 mm		50 m

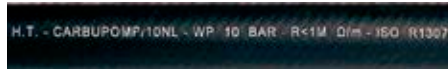



ISO R1307

Manguera para líneas de combustible. Con refuerzo termoplástico que le permite excelente flexibilidad y resistencia a los rayos UV. Color gris. Resistente al alcohol. Especialmente indicado para motores fueraborda.

Marine fuel hose for outboards. Fuel resistant thermo-plastic formulation with 2 spiral reinforcement provides excellent bendability and resistance to UV, aging and permeation by all marine fuels (gasoline/petrol and diesel) including alcohol blends.

Tubi per il condotto del carburante. Con rinforzo termoplastico che gli permette un'eccellente flessibilità e resistenza ai raggi UV. Resistente alle miscele di alcool. Indicato per motori fuoribordo.

Tuyau de carburant marin. La formulation thermoplastique avec 2 renforts en spirale offre une excellente flexibilité et résistance aux UV, au vieillissement et à la perméation de tous les carburants marins (essence et diesel), y compris les mélanges d'alcool.

REF	Ø		
TRI305-0566	8 mm 5/16"	15 m	1
TRI305-0386	10 mm 3/8"	15 m	1

SAE J1527
ISO-8469 B1



ACCESORIOS PARA FILTROS

FILTER ACCESSORIES

ACCESSORI PER FILTRI

ACCESSOIRES POUR FILTRES

LLAVES PARA FILTRO

FILTER KEY

CHIAVE DA FILTRO

CLÉ À FILTRE



RACOR



RECMAR

VÁLVULA DRENAJE AGUA DE FILTROS RACOR

DRAIN VALVE FOR RACOR FILTERS

VALVOLA DRENAGGIO ACQUA PER FILTRI RACOR

VANNE DE DRAINAGE D'EAU POUR FILTRE RACOR

REF
RACRK19492UL

RACOR



SENSOR DE AGUA PARA FILTROS DIESEL

WATER SENSOR FOR DIESEL FILTERS

SENSORE ACQUA PER FILTRI DIESEL

SONDE DE PRESENCE D'EAU POUR DIESEL

REF
RECRK21069

RECMAR



RELOJ SENSOR DE AGUA

WATER ALARM

ALLARME SENSORE ACQUA

ALARME SENSOR D'EAU

REF
RACRK20726

RACOR



BOMBA COMBUSTIBLE MECÁNICA

MECHANICAL FUEL PUMP

REF	OEM	
REC3855276	981650	GM V8, 305, 307, 350



REF	OEM	
REC62092T	982063	FORD V8, 302



POMPA COMBUSTIBILE MECCANICA

POMPE CARBURANT MÉCANIQUE

REF	OEM
REC86234A4	985603 982240 985602



REF	OEM
REC982997	982997





BOMBA COMBUSTIBLE ELÉCTRICA

ELECTRICAL FUEL PUMP

POMPA COMBUSTIBILE MECCANICA

POMPE CARBURANT MÉCANIQUE

REF	OEM		
REC3858261	3858261 3857986 3854620	432, 434, 502, 52 43f, 50f, 57f	8 PSI



new

CARBURADORES

CARBURETORS

CARBURATORE

CARBURATEUR



REF	OEM	
REC1347-818619R02	382733 980530 982217 984180 381498 772831	ROCHESTER 2 BB





REF	OEM	
REC1347-816373A4	981705	ROCHESTER 4 BB
	982223	
	983855	
	981359	
	982215	
	981564	
	985822	
	981803	
	981428	

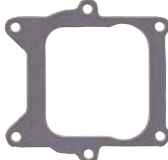



REF	OEM	
REC1347-9661A3	382821	ROCHESTER 4 BB
	383766	
	384194	

REF	OEM	
MP426422	3854087	3.0L (1991-94) 2.0L HO
	772846	

REF	OEM	
RM21610333	3854086	3.0L (1995-97)

JUNTAS BASE	BASE GASKETS	GUARNIZIONE BASE	JOINTS DE BASE
-------------	--------------	------------------	----------------

REF	OEM	
REC315055	315055	ROCHERSTER
REC27-8079821	909758	
REC3853283	3853283	
REC908765	908765	



REC315055



REC27-8079821



REC3853283



REC908765

KITS DE CARBURADOR

CARBURETORS KITS

KIT CARBURATORE

CARBURATEURS KIT

REF	OEM
REC1396-5238	982539

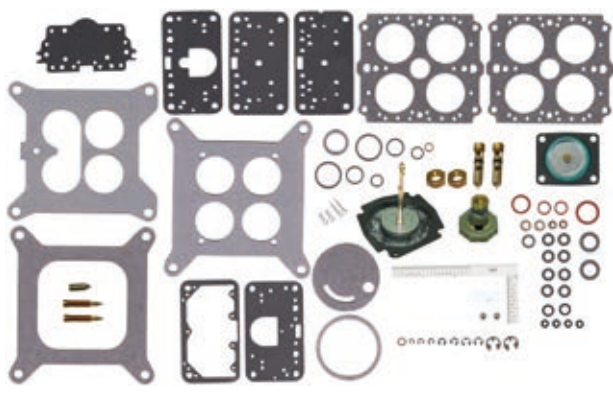

REF	OEM
REC1397-6367A1	508459

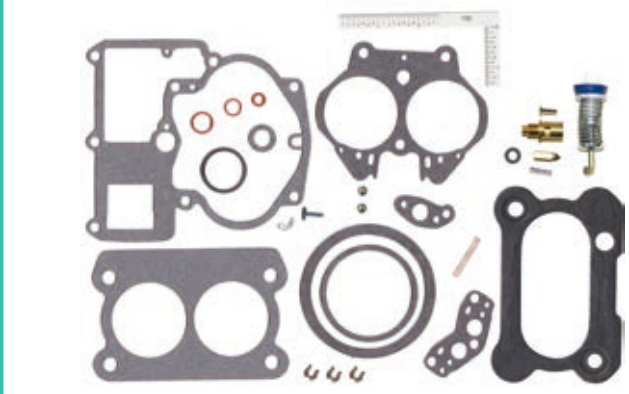

REF	OEM
REC823427A1	982384



REF	OEM
REC823426A1	979659
	384743
	983864
	383918

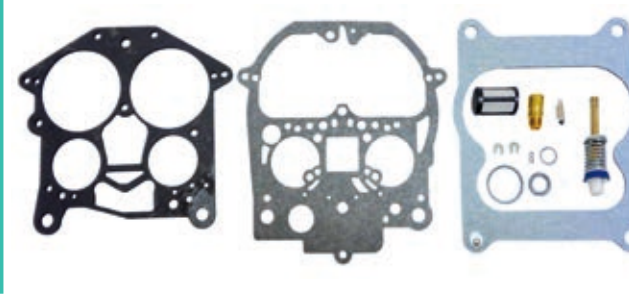

REF	OEM
REC1397-5831	508452

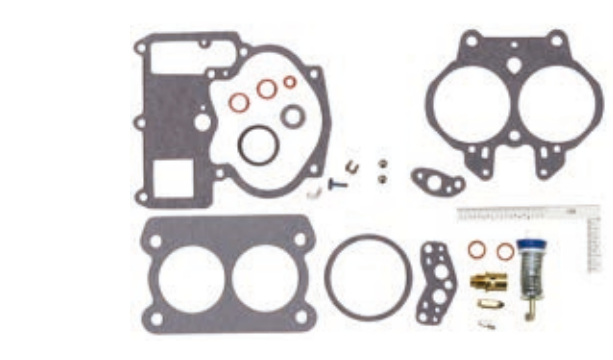

REF	OEM
REC1396-4656	982537
	982538

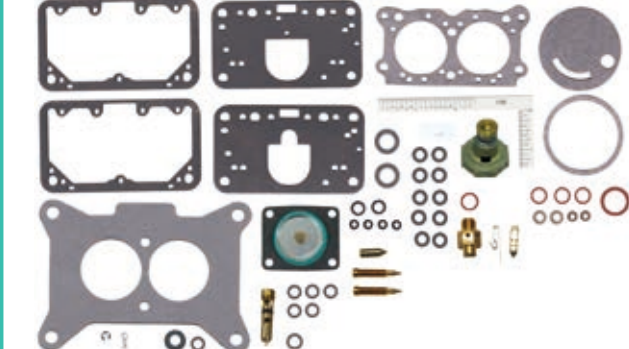

REF	OEM
REC841994	984487
	983073



REF	OEM
REC982386	381400
	982386

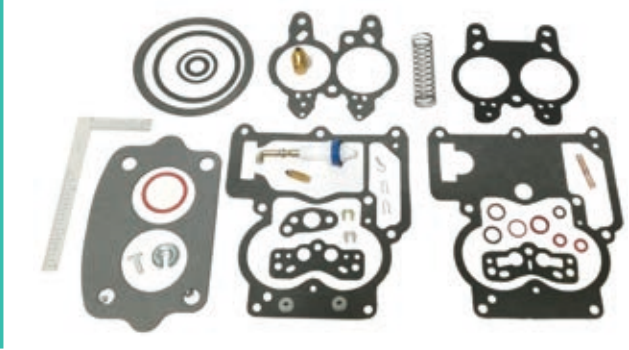

REF	OEM
REC985052	985052

REF	OEM
REC2153394	987438 987440 987485 2153394

REF	OEM
REC986799	986784 986799



REF	OEM
REC3854105	987313 3854105

REF	OEM
REC823427A1	982384

REF	OEM
REC3854020	986796 3854020 3854347

REF	OEM
REC986782	986782

REF	OEM
REC987315	987315

BOYAS		FLOATS	GALLEGGIANTI		FLOTEURS
REF	OEM		REF	OEM	
REC1397-3327	383087 983871		REC1397-2060	381389	

GUÍA CARBURADORES	GUIDE CARBURETORS	GUIDA CARBURATORI	GUIDE DES CARBURATEURS
-------------------	-------------------	-------------------	------------------------

		COD.	CARB.	OEM.
80	1968-69	R2, 2GC	REC1347-818619R02	382733 772831
90	1970-71	R2, 2GC	REC1347-818619R02	382733 772831
155	1967-72	R2, 2GC	REC1347-818619R02	772831
165	1972-76	R2, 2GC	REC1347-818619R02	979821 98053
185	1989	R2, 2GC	REC1347-818619R02	984180
200	1966-68	R2, 2GC	REC1347-818619R02	381494
210	1968-72	R4, 4MV	REC1347-9661A3	382821 383766
215, 225, 230	1971-76	R4, 4MV	REC1347-9661A3	382821
230 (800 Series)	1979-89	R4, 4MV	REC1347-816373A4	981705 982223
245	1972-75	R4, 4MV	REC1347-9661A3	384194
250	1970-74	R4, 4MV	REC1347-9661A3	384194
260 (800 Series)	1975-76	R4, 4MV	REC1347-9661A3	384194
260 (800 Series)	1979-89	R4, 4MV	REC1347-816373A4	982223
3.0L	1991-94		MP426422	772846
3.0L	1995-97		RM21610333	3854086
3.8L (4V)	1979-85	R4, 4MV	REC1347-816373A4	983855
4.3L (4V)	1979-89	R4, 4MV	REC1347-816373A4	983855
5.0L (GM)(4V)	1979-89	R4, 4MV	REC1347-816373A4	982223
5.7L (4V)	1979-89	R4, 4MV	REC1347-816373A4	982223 981359
305, 350 CI, I/B,	1977-83	R4, 4MV	REC1347-816373A4	982215 981564 982223
350 (4V)	1988-89	R4, 4MV	REC1347-816373A4	985822
454 CI, I/B	1977-78	R4, 4MV	REC1347-816373A4	981803 981428

		COD.	MOD.	KIT	
80	1968-69	R2	2GC	REC823427A1	REC1397-2060
90	1970-71	R2	2GC	REC823427A1	REC1397-2060
100	1972-73	C1	RBS	REC1398-3089	
120	1965-71	C1	RBS	REC1398-3089 (2 CARB)	
120	1972-85	R2	2GC	REC982386	REC1397-2060
140	1973-85	R2	2GC	REC823427A1	REC1397-2060
155	1967-72	R2	2GC	REC982386	
165	1972-76	R2	2GC	REC823427A1	REC1397-2060
170	1974	H2	2300	REC1396-4656	
175	1975-77	H2	2300	REC1396-4656	
185	1978-81	R2	2GE	REC841994	REC1397-2060
185	1989	H2	2300	REC1396-4656	
190	1974-77	H2	2300	REC1396-4656	
200	1966-68	R2	2GC,V	REC982386	
200	1979-85	R2	2GE	REC841994	REC1397-2060
200	1989	H2	2300	REC1396-4656	
210	1968-72	R4	4MV	REC823426A1	REC1397-3327
215	1971	R4	4MV	REC823426A1	REC1397-3327
225	1972-76	R4	4MV	REC823426A1	REC1397-3327
230	1975-76	R4	4MV	REC823426A1	REC1397-3327
230	1979-89	R4	4MV	REC823426A1	REC1397-3327
235	1975-77	H4	4160	REC1396-5238	
235	1989	H4		REC985052	
240	1978	H4		REC985052	
245	1972-75	R4	4MV	REC823426A1	REC1397-3327
250	1970-74	R4	4MV	REC823426A1	REC1397-3327
250	1979	H4		REC985052	
260	1975-76	R4	4MV	REC823426A1	REC1397-3327
260	1979-89	R4	4MV	REC823426A1	REC1397-3327
290 JET	1974-75	R4	4MV	REC823426A1	REC1397-3327
2.3 L	1987-89	R2	2GE	REC841994	REC1397-2060
2.5L	1982-85	R2	2GC	REC982386	REC1397-2060
2.5L	1986-90	R2	2GE	REC841994	REC1397-2060
2.5L	1986	R2	2GC	REC823427A1	REC1397-2060
3.0L	1982-90	R2	2GC	REC823427A1	REC1397-2060
3.0L/HO	1991-92	H2	2300	REC21533394	
3.8L	1979-85	R2	2GE	REC841994	REC1397-3327
4.3L	1986-89	R2	2GE	REC841994	REC1397-2060
4.3L	1979-89	R4	4MV	REC823426A1	REC1397-3327
4.3/262	1989	R2	2GE	REC841994	REC1397-2060
4.3 HO	1990-92	H2	2300	REC3854020	
4.3HO	1990-92	H4	4160	REC986799	
5.0L (GM)	1979-85	R2	2GE	REC841994	REC1397-2060
5.0L (GM)	1979-89	R4	4MV	REC823426A1	REC1397-3327
5.0L (Ford)	1989	H2	2300	REC1396-4656	
5.0 HO	1989-90	H2	2300	REC986782	
5.0 HO	1989-90	H4	4160	REC986799	
5.0 HO	1991	H4	4160	REC1396-5238	
5.7L	1979-89	R4	4MV	REC823426A1	REC1397-3327
5.7LE	1991-92	H4	4175	REC987315	
5.8L	1989	H4		REC985052	
7.5L	1987-88	H4		REC985052	
305 C.I.I./B	1977-79	R2	2GE	REC841994	REC1397-2060
305 C.I.I./B	1977-78	R4	4MV	REC823426A1	REC1397-3327
305 C.I.I./B	1979-83	R4	4MV	REC823426A1	REC1397-3327
305 C.I.I./B	1979-83	R4	4MV	REC823426A1	REC1397-3327
350	1988-89	R4	4MV	REC823426A1	REC1397-3327
350	1988	R2	2GE	REC841994	REC1397-2060
454 C.I.I./B	1977-78	R4	4MV	REC823426A1	REC1397-3327
454 HO	1991-92	H4	4150	REC3854105	
460 C.I.	1987-88	H4	-	REC985052	

SISTEMA ELÉCTRICO ELECTRIC SYSTEM

SISTEMA ELETTRICO SYSTÈME ÉLECTRIQUE

SENSORES

SENSORS

SENSORE

CAPTEURS

SENSOR PRESIÓN DE ACEITE

OIL PRESSURE SENDER

SENSORE PRESIONE OLIO

SONDE PRESSION D'HUILE

REF	OEM
REC8M0068784	3857532



SENSOR TEMPERATURA AGUA

WATER TEMPERATURE SENDER

SENSORE TEMPERATURA ACQUA

SONDE TEMPERATURE DE L'EAU

REF	OEM
REC3854159	3854159



REF	OEM	Icon
REC806490T	3853787	



REF	OEM
REC35-03752	



REF	OEM	Icon
REC97258A1	171960	



KIT TEMPERATURA Y PRESION DE ACEITE CON ALARMA

COMPLETE TEMPERATURE & OIL PRESSURE WARNING KIT

KIT TEMPERATURA E PRESSIONE DELL'OLIO CON ALLARME

KIT SONDE TEMPERATURE ET PRESSION D'HUILE AVEC ALARME

REF	OEM
REC41400	

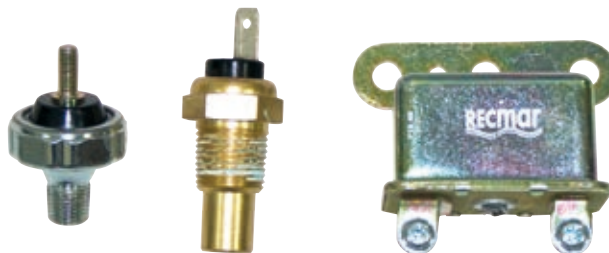

SENSOR TPS

TPS SENDER

SENSORE TPS

CAPTEUR TPS

REF	OEM
REC8M0125617	3855184



VACUÓMETRO. MAP

MAP SENSOR

VACUOMETRO. MAP

CAPTEUR MAP

REF	OEM
REC3850396	3850396



MOTORES DE ARRANQUE

STARTERS

MOTORINI AVVIAMENTO

DÉMARREUR

REF	OEM	⚡	☀️	
REC50-99417A2	982121 981078 988217	12V	9	4 en línea (Tornillos sujeción misma altura) Duty standard rotation 4 in line. In line mounting holes. 4 in linea (viti di supporto parallele) 4 en ligne (vis de fixation parallèles)



REF	OEM	⚡	☀️	🔑	
REC0984628	984628	12V	10		FORD 2.3L & 5.8L Con 3 tornillos de anclaje. 3 mounting holes. Con 3 viti di supporto Avec 3 vis de support



REF	OEM	⚡	☀️	🔑	
REC0984536	984536 988013	12V	10		OMC 460 COBRA



REF	OEM			
REC0987883	3854194			Solenoid Solenoid Solenoid Solenoid



REF	OEM	⚡	☀️	
REC50-97499A2	981289 982202	12V 1.4 kW	9	



REF	OEM	⚡	☀️	🔑	
REC50-808011A05	981288 984982	12V 1.4 kW	9		Contrarrotación o montaje en campana. Counter clockwise starter Controrotante montato nella campana. Contre rotation, installation dans une cloche.



REF	OEM	⚡	☀️	🔑	
RECRA122002		12V	10		Contrarrotación. Counter clockwise starter Controrotante. Contre rotation.



REF	OEM			
REC3854190	987811 3854190	12V	10	Ford 5.0L & 5.8L Con 2 tornillos de anclaje 2 mounting holes Con 2 viti di supporto Avec 2 vis de support

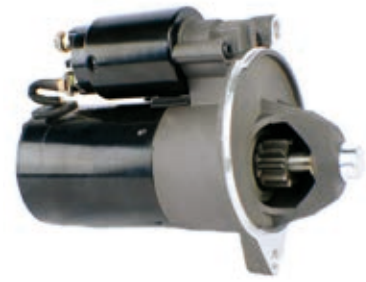

REF	OEM				
REC50-863007A1	3860566	12V 1.4 kW	11	14"	V6 & V8

REF	OEM
REC10-861788	10-861788



REF	OEM			
REC50-99418A2	3860566	12V	9	Tornillos sujeción en diagonal Offset mounting holes Con viti in diagonale Avec vis de support en diagonal

REF	OEM
MP0180-001	10-812509184
REC10-861788	10-861788



REF	OEM				
REC50-806965A4	988217	12V	11	12 ^{3/4} "	COBRA 3.0 L

REF	OEM
MP0180-001	10-812509184
REC10-861788	10-861788



REF	OEM			
REC3885317		12V	11	HEAVY DUTY. GM 454 7.4L Tornillos sujeción en diagonal Offset mounting holes Con viti in diagonale Avec vis de support en diagonal

REF	OEM
REC10-861788	10-861788



REGULADOR REGULATOR REGOLATORE REGULATEUR

REF	OEM	
ARCVR-404	383440	PRESTOLITE



ALTERNADORES

ALTERNATORS

ALTERNATORI

ALTERNATEURS

ALTERNADORES

ALTERNATORS

ALTERNATORI

ALTERNATEUR

REF	OEM	⚡
REC0985964	985964	12V 63 A



REF	OEM	⚡
REC3860769	986008 985964	12V 55 A



REF	OEM	⚡
REC69729	988247	12V 63 A



SOLENOIDES Y RELÉS

SOLENOID & RELAY

SOLENOIDI E RELÉ

SOLENOID ET RELAIS

SOLENOIDE

SOLENOID

SOLENOIDI

SOLENOIDE

REF	OEM	
REC13037	1114356	DELCO REMY



REF	OEM
REC0979774	979774



REF	OEM
REC3853839	982187 985063



REF	OEM
REC0586180	383622 582708 345419 586180



RELÉ BOMBA DE GASOLINA ELECTRICA

RELAY FOR FUEL ELECTRIC PUMP

RELE POMPA BENZINA ELETTRICA

RELAIS POUR POMPE BENZINE ÉLECTRIQUE

REF	OEM
REC3857533	3857533



TRIM

MOTOR TRIM

TRIM ENGINES

MOTORI TRIM

MOTEUR TRIM

REF	OEM	
REC0393988	393259	2
	393988	
	394176	
	391264	
	983019	
	985237	





REF	OEM	
REC382138	986280 3853945	2





REF	OEM	
REC0584107	387277 582048 582155	3



REF	OEM		
ARC6211	983318	3	2.5L, 3.0L (1979-85)



REF	OEM		
REC3853945	986280 3853945	2	COBRA (1987-93)



REF	OEM	
REC0982706	982058 982706	3



LATIGUILLOS TRIM COBRA

ESTRIBOR - BAJADA

REF	OEM
REC3853854	3853854

BABOR - BAJADA

REF	OEM
REC3853856	3853856

TRIM HOSES COBRA

STB - DOWN

PORT - DOWN

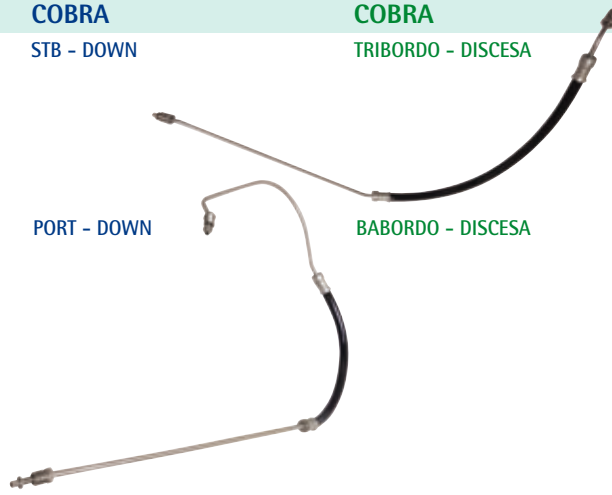

TUBI TRIM COBRA

TRIBORDO - DISCESA

BABORDO - DISCESA

TUYAU TRIM COBRA

TRIBORD - BAS

BABORD - BAS

ESTRIBOR - SUBIDA

REF	OEM
REC3853855	3853855

BABOR - SUBIDA

REF	OEM
REC3853857	3853857

STB - UP

PORT - UP

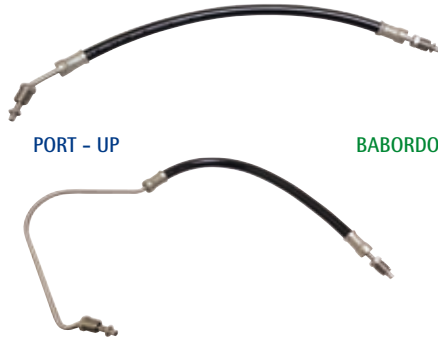

TRIBORDO - SALITA

BABORDO - SALITA

TRIBORD - HAUT

BABORD - HAUT

SENSOR TRIM COBRA

REF	OEM
RM3850470	3850470 0983939 0984731

TRIM SENSOR COBRA

SENSORE TRIM COBRA

CAPTEUR TRIM COBRA



new

SISTEMA DE REFRIGERACIÓN COOLING SYSTEM

SISTEMA DI RAFFREDDAMENTO SYSTÈME DE REFROIDISSEMENT

TERMOSTATO

THERMOSTAT

TERMOSTATO

THERMOSTAT

KITS DE TERMOSTATO

THERMOSTAT KITS

KIT TERMOSTATI

KITS DE THERMOSTAT

REF	OEM		
REC3853799	3853799	Chevys 4 cil. (1980+)	160 °C



REF	OEM		
REC3853983		7.4L (1994-97)	140°



3852111 3852071 3853983

REF	OEM	
REC13430		N000 Chevys 4 cyl. (1980+)





GUIA TERMOSTATOS

THERMOSTAT GUIDE

GUIDA TERMOSTATI

GUIDE THERMOSTAT

	TERMOSTATO THERMOSTAT TERMOSTATO THERMOSTAT	KIT
90	1970	REC13430
100	1972-73	REC13430
120	1969-80	REC13430
120	1980-81	REC3853799
140	1973-80	REC13430
140	1980-81	REC3853799
155	1969-72	REC13430
165	1972-76	REC13430
170	1974	REC13430
175	1975-77	REC13430
185	1978-80	REC13430
190	1974-77	REC13430
200	1979-81	REC13430
210	1969-72	REC13430
215	1971	REC13430
225	1971	REC13430
230	1979-81	REC13430
235	1971	REC13430

	TERMOSTATO THERMOSTAT TERMOSTATO THERMOSTAT	KIT
235	1975-77	REC13430
240	1978	REC13430
245	1972-75	REC13430
250	1970-73	REC13430
250	1979	REC13430
260	1979-81	REC13430
305	1977-82	REC13430
350	1977-82	REC13430
454	1977-82	REC13430
2.5L	1982-88	REC3853799
3.0L	1982-88	REC3853799
3.8L	1981-85	REC13430
4.3L	1985-86	REC13430
5.0L	1982-88	REC13430
5.7L	1982-88	REC13430
7.4L	1994-97	REC3853983
7.5L	1988	REC13430

CUERPO DE TERMOSTATO THERMOSTATO HOUSING

REF	OEM
BAOMC29-314810	314810 982201



REF	OEM
BAOMC29-910303	3854254



REF	OEM
BAOMC29-908216	908216



CORPO TERMOSTATO

REF	OEM
REC3850360	986292 987716 3850360



REF	OEM
HGE5470	985470 Ford 2.3L



BOMBAS ASPIRACIÓN AGUA MARINA

RAW MARINE WATER PUMPS

POMPE ASPIRAZIONE ACQUA MARINA

POMPE À EAU MARINE

BOMBAS DE AGUA

WATER PUMPS

POMPE ACQUA

POMPEÀ EAU

REF	OEM	
SHEG9901	3858847	4.3 & 8.2 (SX)

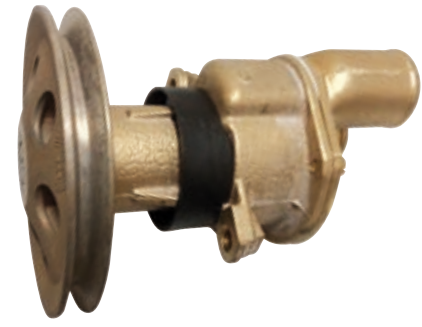

REF	OEM	
SHEG9903	3855079 3851982 3857794	3.0 L (SX)

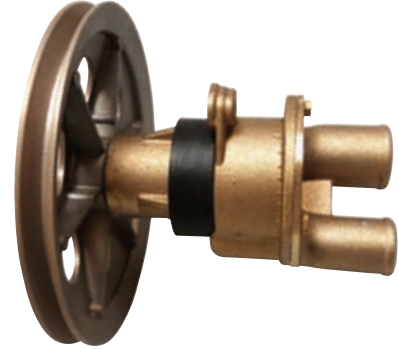

SISTEMA ENCENDIDO IGNITION SYSTEM

SISTEMA DI ACCENSIONE SYSTEME D'ALLUMAGE

BOBINAS

COILS

BOBINE

BOBINES

BOBINA DE ENCENDIDO

IGNITION COIL

BOBINA DI ACCENSIONE

BOBINE D'ALLUMAGE

REF	OEM
REC300-00879	3852217

No usa resistencia externa.
Utilizar con encendido Prestolite.
Use without external resistor & Prestolite ignition
Non utilizza resistenza esterna.
Utilizzare con spinterogeno Prestolite
N'utilise pas de résistance externe.
A utiliser avec l'allumage Prestolite.



REF	OEM	FORD
REC3854161	3854161	FORD

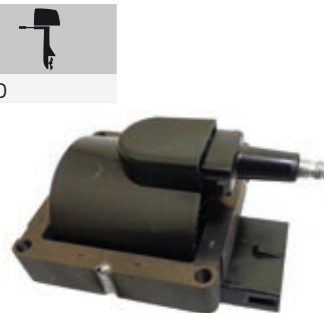

REF	OEM
REC1463-9382	3853548

Resistencia externa.
Utilizar con encendido convencional.
External resistor. Use with conventional ignition
Resistenza esterna.
Utilizzare con accensione convenzionale
Résistance externe.
A utiliser avec un allumage conventionnel.



REF	OEM	GM
REC3854002	3854002	GM



GUÍA DE BOBINAS DE ENCENDIDO

IGNITION COIL GUIDE

GUIDA BOBINA DI ACCENSIONE

GUIDE BOBINE D'ALLUMAGE

		REF
94-93	351 EFI King 5.0L, 5.8L EFI	REC3854161 REC3854161
94-90	3.0L, 3.0L H.O.	REC3854002
94-89	5.0L, 5.0L H.O., 5.8L 5.7L	REC1463-9382 REC1463-9382
94	7.4L	REC1463-9382
93-92	454, 454 H.O., 502	REC1463-9382
93	351 King	REC1463-9382
92-91	5.7L w/Electronic Ign.	REC1463-9382
92-90	5.7LE OMC Cobra (w/Conv. Ign.)	REC1463-9382
92	351	REC1463-9382
91-90	4.3L, 4.3L H.O. (2V Models)	REC1463-9382
90-87	2.3L	REC1463-9382
90	3.0L (PWC)	REC1463-9382
89-88	350 OMC King Cobra 460 OMC King Cobra	REC1463-9382 REC1463-9382
89-85	2.5L, 3.0L, 4.3L Eng.	REC1463-9382
88-86	5.0L, 5.7L	REC1463-9382
88	370 OMC King Cobra	REC1463-9382

		REF
87	335 OMC Cobra 340 OMC King Cobra 7.5L	REC1463-9382 REC1463-9382 REC1463-9382
84-80	120, 140, 185, 200, 230, 260 HP	REC1463-9382
79	120, 140, 185, 200, 230, 250, 260 HP	REC1463-9382
78	120, 140, 185, 225, 230, 240, 305, 350, 454HP	REC1463-9382
77	120, 140, 175, 190, 225, 230, 235 HP	REC1463-9382
76	120, 140, 165, 175, 190, 225, 230, 235 HP	REC1463-9382
75	120, 140, 165, 175, 190, 225, 230, 235, 245,	REC1463-9382
74	120, 140, 165, 225, 245, 250, 290 HP	REC1463-9382
73	100, 120, 140, 165, 225, 245, 250 HP	REC1463-9382
72	100, 120, 155, 165, 210, 225, 245, 250 HP	REC1463-9382
71	90, 120, 155, 210, 215, 235, 250 HP	REC1463-9382

BUJÍAS

SPARK PLUG

CANDELE



BOUGIES

BUJÍAS

SPARK

CANDELE

BOUGIES

			
1990-87	2.3L Cobra	CHARS12YC	NGKTR5
1996	3.0L SX Cobra	CHARS12YC	NGKTR5
1995-90	3.0L Cobra HO	CHARS12YC	NGKTR5
1994-93	3.0L Cobra	CHARS12YC	NGKTR5
1992-87	3.0L Cobra	CHARV15YC4	NGKUR4
1996 (.460*)	4.3L SX Cobra	CHARV15YC4	NGKUR4
1996 (.708*)	4.3L SX Cobra	CHARS12YC	NGKTR5
1995-86	4.3L Cobra	CHARV15YC4	NGKUR4
1991-90	4.3L Cobra HO	CHARV15YC4	NGKUR4
1994-93	4.3L Cobra HO	CHARV15YC4	NGKUR4
1996 (Carb.)	5.0L SX Cobra	CHARV15YC4	NGKUR4
1996 (EFI)	5.0L SX Cobra	CHARS12YC	NGKTR5
1995-96 (Carb.)	5.0L Cobra	CHARV15YC4	NGKUR4
1995-89 (Carb.)	5.0L Cobra HO	CHARV15YC4	NGKUR4
1995-94	5.0L Cobra EFI	CHARS12YC	NGKTR5

			
1993	5.0L Cobra EFI	CHARV15YC4	NGKUR4
1996	5.7L SX Cobra	CHARV15YC4	NGKUR4
1992-86	5.7L King Cobra	CHARV15YC4	NGKUR4
1996 (Carb.)	5.8L SX Cobra	CHARV15YC4	NGKUR4
1996 (EFI)	5.8L SX Cobra	CHARS9YC	NGKTR5
1995-89 (Carb.)	5.8L Cobra	CHARV15YC4	NGKUR4
1995-92 (EFI)	5.8L Cobra	CHARS9YC	NGKTR5
1995-93 (EFI-HO)	5.8L King Cobra	CHARS9YC	NGKTR5
1996	7.4L SX Cobra	CHARV15YC4	NGKUR4
1995-90 (Carb.)	7.4L SX Cobra	CHARV15YC4	NGKUR4
1995 (EFI)	7.4L King Cobra	CHARV15YC4	NGKUR4
1993-91 (Carb.)	7.4L Cobra HO	CHARV15YC4	NGKUR4
1990-86	7.5L Cobra	CHARV15YC4	NGKUR4
1996	8.2L SX Cobra	CHARV15YC4	NGKUR4
1994-92	8.2L King Cobra	CHARV15YC4	NGKUR4

JUEGOS DE CABLES, ALTO RENDIMIENTO

HD SPARK PLUG WIRE SET

KIT CAVI CANDELE, ALTE PRESTAZIONI

KIT FAISCEAU DE BOUGIE

Núcleo del cable de Kevlar de 8 mm antimagnético. Funda de silicona amarilla. Terminales bujías con muelle de acero inox. Terminal del distribuidor de cobre. Terminales bobina. Silicona resistente a altas temperaturas. Garantía de 5 años.

Antimagnetic. Kevlar core. Yellow silicone boot & jacket. SS snaplock. Brass distributor terminal. Coil terminals. High resistant silicone. 5 year warranty.

Nucleo del cavo di Kevlar da 8 mm antimagnetico. Copertura di silicone gialla. Terminali candele con molle di acciaio inox. Terminale lato spinterogeno in rame. Terminale Bobine. Silicone resistente alle alte temperature. Garanzia di 5 anni.

Noyau en Kevlar antimagnétique. Gaine en silicone jaune. Bornes de bougie d'allumage avec ressort en acier inoxydable. Terminal de distribution en laiton. Bornes de bobine. Silicone haute résistance. Garantie de 5 ans.

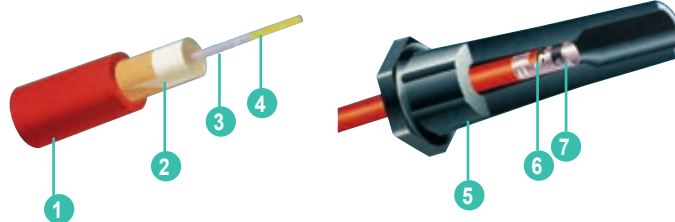

	HD SPARK PLUG WIRE SET	KIT CAVI CANDELE, ALTE PRESTAZIONI	KIT FAISCEAU DE BOUGIE	
1	Camisa de silicona de 8 mm	8 mm silicone jacket	Rivestimento in silicone da 8 mm	Gaine silicone de 8mm
2	Látex resistente altas temperaturas	Heat resistant latex	Latex resistente alle alte temperature	Latex résistant à haute température
3	Acero inox	Stainless Steel	Acciaio inox	Acier inox
4	Núcleo de Kevlar	Kevlar core	Nucleo de Kevlar	Noyau de Kevlar
5	Capuchón de silicona	Silicone jacket	Rivestimento in silicone	Capuchon en silicone
6	Trenzado especial fibra de vidrio	Fiberglass braiding	Fibra di vetro	Tresse en fibre de verre
7	Terminal de acero inox	Stainless Steel terminal	Terminale di acciaio inox	Terminal en acier inox

	ARRANQUE IGNITION AVVIAMENTO DEMARRAGE				
	CYL	CONVEN.	ELECT.	REF	OEM
110 / 120 / 2.5L / 140 / 3.0L / 140 JET	4	✓		REC15-401	
3.0L / HO	4		✓	REC15-405	503748
185 (6 en línea in line in rete en ligne)	6	✓		REC15-602	503748
3.8 L / 4.3 L (229, 262) V6	6	✓		REC15-604	
4.3L (262) V6	6		✓	REC15-601	503750
175 / 185 / 190 / 20 / 5.0 L - 5.7 L / (GM) (Mallory)	8	✓		REC15-801	503751
				REC15-806	503752
5.0 L - 5.8 L (FORD)	8	✓		REC15-806	503755
				REC15-805	503753
5.0 L - 5.8 L - EFI (FORD)	8		✓	REC15-801	503754
				REC15-806	503754
225 / 230 / 235 / 240 / 250 / 260 (Mallory)	8	✓		REC15-801	503752
				REC15-801	503755
370 KING / 454 / 7.4 L / 502 / 8.2 L	8	✓		REC15-801	503752
				REC15-811	503755
460 KING	8	✓		REC15-811	503755

MÓDULOS IGNICIÓN

IGNITION MODULES

MODULI AVVIAMENTO

MODULES D'ALLUMAGE

REF	OEM
REC3854001	3854001 986642

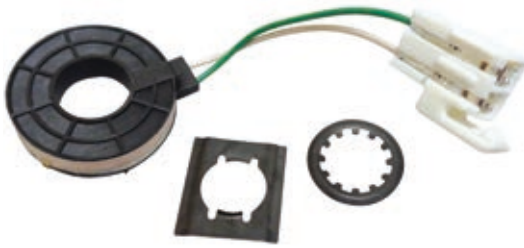

REF	OEM	Icon
REC3854003	3854003 986650	4L, V8



DISTRIBUIDOR

DISTRIBUTOR

SPINTEROGENO

ALLUMEUR

REF	OEM	Icon
REC195141	GM 4 CIL.	



REF	OEM	Icon
REC392-6316	FORD 302 CID V8	



REF	OEM	Icon
REC17177A1	17177A1	GM V8



REF	OEM	Icon
REC392-6330	985764	FORD 351 CID V8

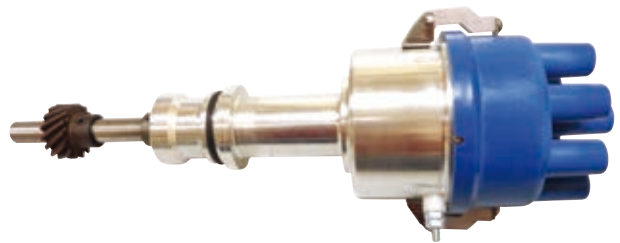

TAPA DISTRIBUIDOR

DISTRIBUTOR CAPS

CALOTTE SPINTEROGENO

TÊTE D'ALLUMEUR

REF	OEM	Icon
REC393-9459Q1	380541	4 Cyl



REF	OEM	Icon
REC33765T	980152	6 CYL



REF	OEM	Icon
REC12532	382133	MALLORY V8



REF	OEM	Icon
REC3854217	3854217	V8 EFI



REF	OEM	
REC33708	383587	V8





REF	OEM	
REC982209	982209	MALLORY V8



REF	OEM	
REC392-9086T	3853814	PRESTOLITE V6



REF	OEM	
REC835702	982336	PRESTOLITE V8 Clip



REF	OEM	
REC392-9766	3853815	PRESTOLITE V8 Con tornillo Screw on Con vite Avec vis



REF	OEM	
REC985218	985218	MALLORY 4 cyl



REF	OEM	
REC3854260	3854260	4 cyl



TAPA DISTRIBUIDOR, ENCENDIDO ELECTRONICO **DISTRIBUTOR CAPS ELECTRONIC IGNITION** **CALOTTE SPINTEROGENO ACCESIONE ELETTRONICO** **TÊTE D'ALLUMEUR ALLUMEUR ÉLECTRIQUE**

REF	OEM	
REC3854331	3854331	DELCO V6



REF	OEM	
REC3854548	3854548	DELCO V8





CONDENSADORES **CONDENSERS** **CONDENSATORI** **CONDENSATEUR**

REF	OEM	
REC8M6001249	987895	PRESTOLITE V6 & V8



REF	OEM	
REC8M6001217	382136 382125	MALLORY & DELCO V8



REF	OEM	
REC33662	380537	DELCO 4 & 6 CIL.





ROTORES

ROTORS

ROTORI

DOIGT D'ALLUMEUR

REF	OEM		
REC3853801	3853801	PRESTOLITE V6 et V8	

REF	OEM		
REC3854261	3854261	DELCO 4 cyl	

REF	OEM		
REC834975	980892	PRESTOLITE V8 Clip	

REF	OEM		
REC3854549		DELCO V6	

REF	OEM		
REC89825302	982211	MALLORY V8	

REF	OEM		
REC58217	384735	DELCO 4 et 6 cyl	

REF	OEM		
REC841243	982342	MALLORY V8 Plano Flat piatto plane	

REF	OEM		
REC3854311		DELCO V8 Encendido electrónico Electronic ignition Accessione elettronico Allumage électronique	

PLATINOS



POINTS



PUNTINE

VIS PLATINEES

REF	OEM		
REC34235T	380538	DELCO 4 et 6 cyl	

REF	OEM		
REC391-5090	382135	MALLORY V8	

REF	OEM		
REC33700	380543	DELCO V8	

REF	OEM		
REC8M6001219	980893 987136 987894	PRESTOLITE V6 et V8	

KITS DE ENCENDIDO

TUNE UP KITS

KIT D'ACCENSIONE

KITS D'ALLUMAGE

REF	OEM	
REC801766		

REF	OEM	
REC3423A1		

REC58217 + REC34235T + REC33662



KITS DE CONVERSIÓN ELECTRÓNICO

Sustituyen condensadores y contactos por componentes electrónicos. Usa bobina, tapa y rotor estándar. Fácil instalación, una pieza y dos cables. Precisión entre 1/4" calibrado de 0 a 8000 rpm.

ELECTRONIC CONVERSION KITS

To substitute condensers for electronic devices. Uses standard coil, cap & rotor. Easy installation; one piece, two cables. Precisely calibrated between 1/4" from 0 to 8000.

KIT DI CONVERSIONE ELETTRICO

Sostituiscie condensatori e contatti per componenti elettronici. Utilizza bobina, calotta e rotore standard. Facile installazione, una pz e due cavi. Precisione 1/4" calibrato da 0 a 8000.

KITS DE CONVERSION ÉLECTRONIQUE

Remplace les condensateurs et les contacts par des composants électroniques. Utilise une bobine, un couvercle et un rotor standard. Installation facile, une seule pièce et deux fils. Précision de 1/4" calibrée de 0 à 8000 rpm.

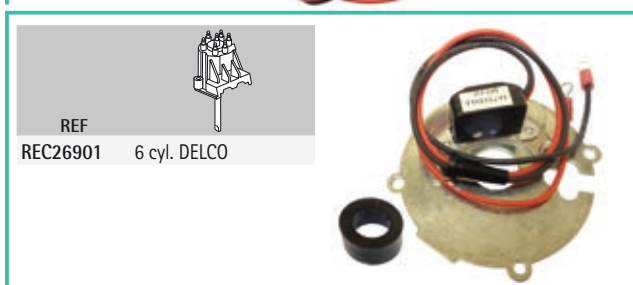

MÓDULO SISTEMA CAMBIO

SHIFT ASSIST MODULE

MODULO SISTEMA CAMBIO

MODULE, SYTÈME DE CHANGEMENT

REF	OEM	CYL
REC987739	982755	4
	984281	
	985902	
	982774	
	984036	6
	986342	
	987740	
	982749	
	984276	8
	984730	
	986837	
	987738	
	987739	



PARTES DEL MOTOR ENGINE PARTS

PARTI MOTORE PIECES MOTEUR

JUNTAS PARA BASES GM Y FORD

Los Kits están diseñados y catalogados específicamente para aplicaciones marinas. Su calidad es superior a las juntas originales.

MARINE GASKETS TO GM & FORD ENGINES

The gaskets kits are designed and cataloged specifically for marine engine applications. Their quality is even better than the oem's.

GUARNIZIONI PER MOTORI GM E FORD

I kit di guarnizioni sono disegnati e fabbricati specificatamente per applicazioni marine. La qualità è assolutamente paragonabile a quelle originali.

JOINTS POUR MOTEURS GM ET FORD

Les kits sont spécifiquement conçus et catalogués pour les applications marines. Leur qualité est supérieure à celle des joints d'origine.











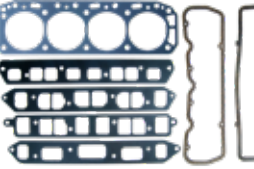

SERIE SERIAL				
1700-17099	KIT JUNTAS DE CULATA (pack individual)	CYLINDER HEAD GASKET (single-packed)	GUARNIZIONI TESTATA (quantità 1)	KIT JOINTS DE CULASSE (paquet individuel)
17100-17199	JUEGOS DE CONVERSIÓN Todas las juntas y retenes de aceite que no se encuentran en los juegos de culata. Incluye las juntas del cárter y los retenes.	CONVERSION KITS All gaskets and oil seals not found in a Head Set. This includes timing cover gaskets and seals, oil pan gaskets, and rear main bearing seals.	KIT PARTE BASSA Include tutte le guarnizioni ed i paraoli della parte bassa del motore, viene fornita anche la guarnizione della coppa dell'olio.	KITS DE CONVERSION Tous les joints d'étanchéité et joints d'huile qui ne sont pas contenus dans les kits de culasse. Comprend les joints de carter et les joints d'huile.
17200-17299	KIT DE DESCARBONIZACIÓN Todas las juntas y retenes necesarios para el trabajo de las válvulas, incluyendo la culata, la tapa de la válvula y juntas de colector de admisión y colector de escape. (Los juegos de 4 cyl no contienen las juntas del colector de admisión/escape. Deben pedirse por separado).	HEAD SETS SERIES All gaskets and seals necessary for a valve grinding job, including cylinder head gaskets, valve cover gaskets, intake & exhaust manifold gaskets (except 4 cyl intake set), and valve stem seals.	KIT PARTE ALTA (SMERIGLIO) Include tutte le guarnizioni ed i paraoli della parte alta del motore, testate, carter distribuzione, aspirazione e scarico. (Motori a 4 cyl. la guarnizione aspirazione è da ordinare separatamente).	KIT DE DÉCARBONISATION Tous les joints requis pour le travail sur les soupapes, y compris les joints de culasse, de couvercle de soupape, de collecteur d'admission et d'échappement (les kits 4 cylindres ne contiennent pas de joints de collecteur d'admission/échappement). Ils doivent être commandés séparément.
17300-17399	KIT DE COLECTOR DE ADMISIÓN Juntas de la parte de admisión del colector, retenes y juntas de la base del distribuidor.	INTAKE MANIFOLD SETS Intake manifold side gaskets, intake manifold end seals, and distributor mounting gasket.	KIT GUARNIZIONE ASPIRAZIONE Guarnizioni laterali del collettore di aspirazione, guarnizioni e guarnizioni della base del distributore.	KIT DE COLECTEUR D'ADMISSION Joints de collecteur d'admission, joints d'étanchéité et joints de base de distributeur.
17400-17499	KIT DE COLECTOR DE ESCAPE (de colector a culata)	EXHAUST MANIFOLD (manifold-to-cylinder head gaskets)	KIT GUARNIZIONE SCARICO (dalla testata al collettore)	KIT COLLECTEUR D'ÉCHAPPEMENT (collecteur à la culasse)
17700-17749	KIT DE CONTRARROTACIÓN RETÉN TRASERO DEL CIGÜENAL Retenes traseros del cigüeñal diseñados para motores de rotación opuesta a la normal. (Retenes de rotación normal incluidos en el set de conversión)	REVERSE ROTATION REAR MAIN BEARING SEAL SETS Rear main bearing seals designed to seal a crankshaft which rotates in the opposite direction from normal (Standard rotation seal is included in conversion set)	PARAOLIO MOTORI CONTROROTANTI ALBERO MOTORE Nei motori rotazione STD il paraolio viene già incluso nel kit della parte bassa. (Guarnizioni a rotazione normale incluse nel set di conversione)	KIT CONTRE-ROTATION JOINTS D'HUILE DE VILEBREQUIN ARRIÈRE Joints de vilebrequin arrière conçus pour les moteurs à contre-rotation (joints à rotation normale inclus dans le kit de conversion).
17750-17799	KIT DE RETENES TAPA DEL CIGÜENAL DE CONTRARROTACIÓN Retenes de la tapa del cigüeñal diseñados para motores de rotación opuesta a la normal. (Retenes de rotación normal incluidos en el set de conversión).	REVERSE ROTATION TIMING COVER SEAL SETS SERIES Timing cover seals designed to seal crankshaft which rotates in the opposite direction from normal (standard rotation seal is included in Conversion set and Timing cover set)	PARAOLIO CARTER DISTRIBUZIONE CONTROTOTANTI Guarnizioni del coperchio dell'albero a gomiti progettate per motori controrotanti (le guarnizioni per la rotazione normale sono incluse nel set di conversione).	KIT DE JOINTS DE COUVERCLE DE VILEBREQUIN CONTRE-ROTATIF Joints de couvercle de vilebrequin conçus pour les moteurs à contre-rotation (joints à rotation normale inclus dans le kit de conversion).
17900-17949	KIT DE TAPA VÁLVULA Todas las juntas de las tapas de las válvulas para sellar el motor.	VALVE COVER SET SERIES All valve cover or push rod cover gaskets (and grommets if required) required to seal one engine.	KIT COPERCHIO PUNTERIE Tutte le guarnizioni del coperchio della valvola per sigillare il motore.	KIT DE COUVERCLE DE SOUPAPE Tous les joints de couvercle de soupape pour l'étanchéité du moteur.
17950-17999	KIT DE CÁRTER Todas las juntas y retenes del cárter de aceite, o la junta del cárter de aceite de goma moldeada de una pieza, necesarias para sellar un motor.	OIL PAN SETS SERIES All oil pan gaskets & seals, or one-piece molded rubber oil pan gasket, required to seal one engine.	GUARNIZIONE COPPA DELL'OLIO Tutte le guarnizioni e le tenute della coppa dell'olio, o la guarnizione in gomma stampata in un unico pezzo, necessarie per sigillare un motore.	KIT DE CARTER D'HUILE Tous les joints de carter d'huile, ou un joint de carter d'huile en caoutchouc moulé d'une seule pièce, nécessaires à l'étanchéité d'un moteur.







2.5L (100HP, 110HP, 120HP)

	REF	OEM	CULATA	CYLINDER HEAD	TESTATA	CULASSE
	REC17000	3853336 908611	JUNTA CULATA	CYLINDER HEAD	GUARNIZIONE TESTATA	JOINT DE CULASSE
	REC17200		KIT JUNTAS SUPERIOR	GASKET HEAD SET	KIT PARTE ALTA	KIT DE JOINTS SUPÉRIEURS
	REF		INFERIOR	CONVERSION	PORTE BASSA	PARTIE BASSE
	REC17100		Retén 2 piezas, 4 piezas junta cárter.	2 piece rear main bearing seal & 4 piece oil pan gasket	Paraolio in 2 px, 4 pz guarnizione coppa dell'olio.	Joint d'huile 2 pièces, joint de carter 4 pièces.

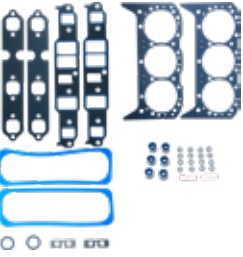
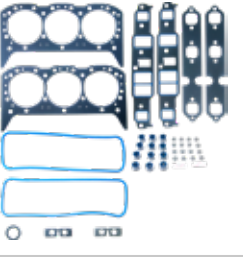
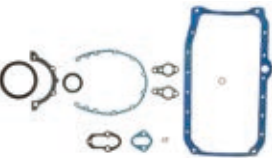
	REF	COLECTOR ADMISION-ESCAPE	MANIFOLD INTAKE & EXHAUST	COLLETTORE ASPIRAZIONE-SCARICO	COLLECTEUR ADMISION ET ÉCHAPPEMENT
	REC27-96429	COBRA	COBRA	COBRA	COBRA
	REC27-815528	3853256  COBRA	 COBRA	 COBRA	 COBRA
	REF	CARTER	OIL PAN	COPPA DELL'OLIO	CARTER
	REC17950	3853343 KIT JUNTAS CARTER Retén trasero dos piezas, 4 piezas junta cárter.	GASKET OIL PAN SET Two piece rear main bearing seal & 4 piece oil pan gasket	KIT GUARNIZIONE Paraolio posteriore in 2, guarnizione coppa in 4 pz.	KIT DE JOINTS CARTER Joint arrière en deux parties, Joint de carter 4 pièces.
	REF	TAPA VÁLVULAS	VALVE COVER	COPERCHIO VALVOLE	COUVERCLE
	REC17900	3852693 Junta	Gasket	Guarnizione	Joint
	REF	TAPA EMPUJADORES	PUSH ROD COVER	COPERCHIO ASTE PUNTERIE	COUVERCLE
	REC17903	3856443 Junta	Gasket	Guarnizione	Joint



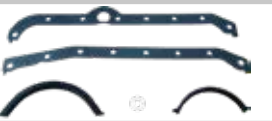



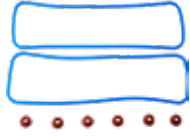

3.0L (115 HP), 3.0L HIGH OUTPUT (130 HP), 130/3.0L (130 HP), 140/3.0L (140 HP)

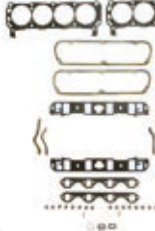
	REF	OEM	CULATA	CYLINDER HEAD	TESTATA	CULASSE
	REC17000	3853336 908611	JUNTA CULATA	CYLINDER HEAD	GUARNIZIONE TESTATA	JOINT DE CULASSE
	REC17200		KIT JUNTAS SUPERIOR	GASKET HEAD SET	KIT PARTE ALTA	KIT DE JOINTS SUPÉRIEURS
	REF	OEM	INFERIOR	CONVERSION	PARTE BASSA	PARTIE BASSE
	REC17102		KIT JUNTAS Retén 1 pieza. Junta cárter 1 pieza.	GASKET SET 1 piece rear main bearing seal 1 piece oil pan gasket	KIT Paraolio in 1 pz. Guarnizione coppa dell'olio in 1 pz.	KIT JOINTS INFÉRIEURS Joint spi 1 pièce. Joint de carter 1 pièce.
	REC17100		Retén 2 piezas, 4 piezas junta cárter.	2 piece rear main bearing seal & 4 piece oil pan gasket	Paraolio in 2 px, 4 pz guarnizione coppa dell'olio.	Joint d'huile 2 pcs, 4 pièces de joint de carter.
	REF	COLECTOR ADMISION-ESCAPE	MANIFOLD INTAKE & EXHAUST	COLLETTORE ASPIRAZIONE-SCARICO	COLLECTEUR ADMISION ET ÉCHAPPEMENT	
	REC27-96429	COBRA con tapa de colector desmontable.	COBRA with removable end cap.	COBRA con coperchio collettore smontabile	COBRA avec couvercle de collecteur détachable	
	REC27-815528	COBRA sólo H.O. Colector de una pieza	COBRA, H.O. only with 1 piece manifold.	COBRA solo H.O. collettore in 1 pz.	COBRA H.O. Collecteur de 1 pièce.	
	REC27-53354	 COBRA.	 COBRA.	 COBRA	 COBRA	
	REF	CARTER	OIL PAN	COPPA DELL'OLIO	CARTER	
	REC17950	KIT JUNTAS Retén trasero dos piezas, 4 piezas junta cárter.	GASKET SET Two piece rear main bearing seal & 4 piece oil pan gasket	KIT GUARNIZIONE Paraolio posteriore in 2, guarnizione coppa in 4 pz.	KIT DE JOINTS Joint arrière en deux parties, Joint de carter 4 pièces.	
	REF	TAPA VÁLVULAS	VALVE COVER	COPERCHIO VALVOLE	COUVERCLE SOUPAPES	
	REC17900	3852693 Junta	Gasket	Guarnizione	Joint	
	REF	TAPA EMPUJADORES	PUSH ROD COVER	COPERCHIO ASTE PUNTERIE	COUVERCLE	
	REC17903	3856443 Junta	Gasket	Guarnizione	Joint	

4.3L (150, 160, 175, 180 Et 205 HP)						
	REF	CULATA	CYLINDER HEAD	TESTATA	CULASSE	
	REC17010	3854299	Se necesitan dos	2 required	Necessarie 2	Deux sont nécessaires
	REC17210		Motor sin eje equilibrado. Incluye juntas tapa válvulas y retenes.	Engine without balance shaft; valve cover gskts and premium valve stem seals incl.	Motore senza asse bilanciato. Include guarnizione coperchio punterie e paraoli valvole.	Moteur sans arbre équilibré. Comprend les joints de couvre-soupapes et les joints d'étanchéité.
	REC17211		Motor con eje equilibrado. Incluye juntas tapa válvulas y retenes.	Engine with balance shaft; valve cover gskts and premium valve stem seals incl.	Motore con asse bilanciato. Include guarnizione coperchio punterie e paraoli valvole.	Moteur avec arbre équilibré. Comprend les joints de couvre-soupapes et les joints d'étanchéité.
	REF	INFERIOR	CONVERSION	PARTE BASSA	PARTIE BASSE	
	REC17115		Motor sin eje equilibrado con retén de una pieza y 1 pieza junta cárter. Incluye Junta de cárter.	Engine without balance shaft with one-piece rear main bearing seal & 1 piece oil pan gasket; oil pan gasket incl.	Motore senza asse bilanciato. Paraolio post in 1 pz e guarnizione coppa in 1 pz. Include la guarnizione del carter.	Moteur équilibré sans arbre, avec joint d'huile en une pièce et joint de carter en une pièce, y compris le joint de carter.
	REC17110		Motor sin eje equilibrado con retén de 2 piezas y 4 piezas junta cárter. Incluye Junta de cárter.	Engine without balance shaft with 2 piece rear main bearing seal & 4 pieces oil pan gasket; oil pan gasket incl.	Motore senza asse bilanciato. Paraolio post in 2 pz e guarnizione coppa in 4 pz. Include la guarnizione del carter.	Moteur équilibré sans arbre avec joint d'huile 2 pièces et joint de carter 4 pièces. Comprend un joint de carter.
	REC17116		Retén de 1 pieza.	1 piece rear gasket.	Paraolio posteriore in 1 pz	joint spi 1 pièce
	REF	COLECTOR ADMISION-ESCAPE	MANIFOLD INTAKE & EXHAUST	COLLETTORE ASPIRAZIONE-SCARICO	COLLECTEUR ADMISION ET ÉCHAPPEMENT	
	REC17310	857177	Junta Admisión-Escape	Intake-Exhaust Gasket	Guarnizione aspirazione-scarico	Joint admission et échappement
	REC27-99757	3853412	Kit juntas colector - escape	Exhaust gasket set	Kit guarnizione scarico	Kit joints collecteur d'échappement
	REF	CARTER	OIL PAN	COPPA DELL'OLIO	CARTER	
	REC17970		KIT JUNTAS CARTER 4 piezas junta cárter. (Retén 2 piezas)	GASKET OIL PAN SET 4 piece oil pan gasket (2 piece Seal)	KIT GUARNIZIONE Guarnizione coppa in 4 pz. (paraolio 2 pz)	KIT JOINTS 4 pièces carter.
	REC17971	3852655	1 junta carter (Retén 1 pieza)	1 piece oil pan gasket (1 piece seal)	Guarnizione coppa in 1 pz (paraolio 1 pz)	1 joint carter (Joint d'huile 1 pièce)

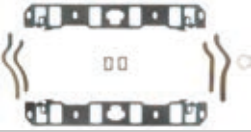



REF	TAPA VÁLVULAS	VALVE COVER	COPERCHIO VALVOLE	COUVERCLE SOUPAPES
	REC17920 3854300 Motor sin eje equilibrado.	Engine without balance shaft	Motore senza asse equilibrato.	Moteur sans arbre équilibré.
	REC17921 3854942 Motor con eje equilibrado.	Engine with balance shaft	Motore con asse equilibrato.	Moteur avec arbre équilibré





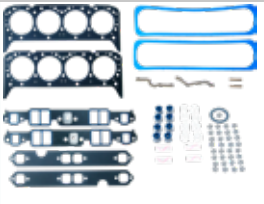
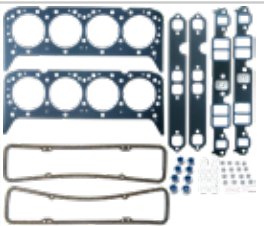

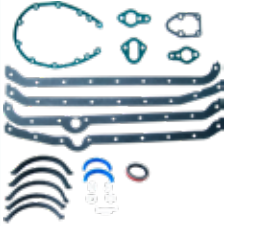
5.0L (160, 170, 185 HP), 5.0L HIGH OUTPUT (175, 190, 200 HP), 175 (175 HP), 190 (190 HP)

REF	CULATA	CYLINDER HEAD	TESTATA	CULASSE
	FEL17060 Se necesitan dos	2 required	Necessarie 2	Deux sont nécessaires
	FEL17261 Con tapa válvulas de aluminio. Incluye retenes de válvulas.	With cast aluminum valve covers. Premium valve stem seals included.	Con coperchio punterie in alluminio. Include paraolio valvole.	Avec le cache culbuteur en Aluminium. Comprend les joints de queue de soupape.
	FEL17260 Incluye retenes de válvulas.	Premium valve stem seals included.	Include paraoli valvole.	Comprend les joints de queue de soupape.
REF	INFERIOR	CONVERSION	PARTE BASSA	PARTIE BASSE
	FEL17161 Retén 1 piezas, 1 pieza junta cárter. Incluye junta de cárter.	1 piece rear main bearing seal & 1 piece oil pan gasket. Rubber oil pan gasket included.	Paraolio in 1 pz, 1 pz guarnizione coppa dell'olio. Include guarnizione coppa.	Joint spi 1 pièce Joint de carter 1 pièce. Comprend le joint de carter.
	FEL17160 Retén 2 piezas, 4 piezas junta cárter.	2 piece rear main bearing seal & 4 piece oil pan gasket.	Paraolio in 2 pz, 4 pz guarnizione coppa dell'olio.	Joint spi 2 pièces Joint de carter 4 pièces.
REF	COLECTOR ADMISIÓN-ESCAPE	MANIFOLD INTAKE & EXHAUST	COLLETTORE ASPIRAZIONE-SCARICO	COLLECTEUR ADMISION ET ÉCHAPPEMENT
	FEL17360 Kit junta admisión	Intake gasket set	Kit guarnizioni aspirazione	Kit joints d'admission
	REC3852455 Junta escape	Exhaust gasket	Guarnizione scarico	Joints collecteur d'échappement
REF	CARTER	OIL PAN	COPPA DELL'OLIO	CARTER
	FEL17995 Retén 2 piezas	2 pieces seal	Paraolio 2 pz	Joint spi 2 pièces
	FEL17997 1 pieza junta de goma.	1 piece oil pan gasket	Guarnizione 1 pz	1 Joint de carter de caoutchouc.
REF	RETÉN TRASERO CIGÜEÑAL	CRANKSHAFT REAR SEAL	PARAOLIO POSTERIORE ALBERO MOTORE	JOINT ARRIÈRE DE VILEBREQUIN
	FEL17746 Retén partido Contrarrotación, goma; 2 piezas	Split seal Rev. rotation, rubber; 2 piece	Controrotazione in 2 pz.	Joint fendu contre-rotatif, caoutchouc ; 2 pcs.

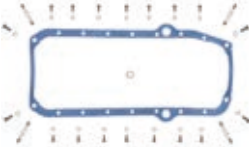

REF	TAPA VÁLVULAS	VALVE COVER	COPERCHIO VALVOLE	COUVERCLE SOUPAPES
 FEL17945	Con tapa de válvulas de acero	With iron valve cover	Con coperchio valvole in acciaio	Cache culbuteur en acier
 FEL17946	Con tapa válvulas de aluminio.	With cast aluminium valve covers.	Con coperchio valvole in alluminio.	Cache culbuteur en Aluminium
REF	RETÉN DISTRIBUCIÓN	OIL SEAL TIMING COVER	PARAOLIO DISTRIBUZIONE	JOINT D'HUILE DE DISTRIBUTION
 REC3853341	Retén contrarrotación tapa distribución	Rev. rotation timing cover seal	paraolio contrarotazione	Joint contre-rotation couvercle distribution





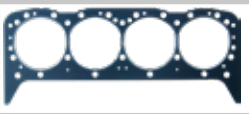
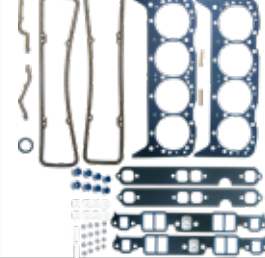

5.0L V8 (185, 200, 225, 230 HP)

REF	CULATA	CYLINDER HEAD	TESTATA	CULASSE
 REC17020	3853380 Se necesitan dos	2 required	Ne servono 2	2 sont nécessaires
 REC17224	Tornillo centro tapa válvulas. Incluye retenes válvulas.	With center bolt desing valve covers. Premium valve stem seals included.	Viti coperchio punterie al centro. Include paraoli valvole.	Cache culbuteur avec les vis centrales. Comprend les joints de queue de soupapes.
 REC17220	Tornillo en el lateral tapa válvulas. Incluye retenes válvulas.	Rim bolt desing valve covers. Premium valve stem seals included.	Viti coperchio punterie nel perimetro. Include paraoli valvole.	Cache culbuteur avec les vis laterales. Comprend les joints de queue de soupapes.
REF	INFERIOR	CONVERSION	PARTE BASSA	PARTIE BASSE
 REC17125	Retén de 1 pieza y junta cárter de 1 pieza Incluye junta de cárter.	One-piece rear main bearing seal & 1 piece oil pan gasket. Oil pan gasket included.	Paraolio in 1 peze e guarnizione coppa in 1 peze. Include paraolio coppa.	Joint spi 1 pièce. Joint de carter 1 pièce. Comprend le Joint spi.
 REC17120	Retén de 2 piezas y junta cárter de 4 piezas	Two-piece rear main bearing seal & 4 pieces oil pan gasket.	Paraolio in 2 peze e guarnizione coppa in 4 pezi.	Joint spi 2 pièces et joint de carter 4 pièces.
REF	COLECTOR ADMISION-ESCAPE	MANIFOLD INTAKE & EXHAUST	COLLETORE ASPIRAZIONE-SCARICO	COLLECTEUR ADMISSION ET ECHAPPEMENT
 REC17320	856365 Kit Juntas Admisión-Escape	Intake-Exhaust Gasket Set	Kit guarnizioni aspirazione - SCARICO	Kit joints d'admission
 REC27-33395	856034 Kit juntas colector escape	Oil pan - exhaust gasket set.	Kit guarnizione Coppa olio - scarico.	Kit joints collecteur d'échappement.

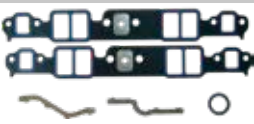
	REF	CARTER	OIL PAN	COPPA DELL'OLIO	CARTER	
	REC17982	3856138	Junta cárter 1 pieza. Junta de cárter incluida.	1 piece oil pan gasket. Molded rubber oil pan gasket included.	Guarnizione in 1 pz. Guarnizione coppa included.	Joint de carter 1 pièce.
	FEL17983		Junta 1 pieza. Para motores con retén trasero de 2 piezas.	1 piece molded rubber gasket for engines with Two-piece rear main bearing sea.	Guarnizione in 1 pz, paraolio posteriore in 2 px.	Joint de carter 1 pièce pour moteurs avec Joint spi arrière 2 pièces.
	REC17980	855729	Varilla aceite de BABOR con retén trasero de 2 piezas y junta cárter de 4 piezas.	PORT dipstick with 2-piece rear main bearing seal & 4-piece oil pan gasket.	Asticella olio a SINISTRO con paraolio posteriore in 2 pz. e guarnizione coppa da 4 pz.	Jauge d'huile à BABORD avec Joint spi arrière en 2 pièces et joint de carter en 4 pièces.
	REC17981		Varilla aceite de ESTRI-BOR con retén trasero de 2 piezas y junta cárter de 4 piezas.	STARBOARD dipstick with 2-piece rear main bearing seal & 4-piece oil pan gasket	Asticella olio DESTRO con paraolio posteriore in 2 pz e guarnizione coppa da 4 pz.	Jauge d'huile à TRIBORD avec Joint spi arrière en 2 pièces et joint de carter en 4 pièces.
	REF	RETÉN TRASERO CIGÜENAL	CRANKSHAFT REAR SEAL	PARAOLIO POSTERIORE ALBERO MOTORE	JOINT ARRIÈRE DE VILEBREQUIN	
	FEL17725		Retén partido Contrarrotación, goma; 2 piezas	Split seal Rev. rotation, rubber; 2 piece	Controrotazione in 2 pz.	Joint fendu contre-rotatif, caoutchouc ; 2 pcs.
	REF	TAPA VÁLVULAS	VALVE COVER	COPERCHIO VALVOLE	COUVERCLE SOUPAPE	
	REC17931	3852687	Tornillo centro tapa válvulas con juntas.	Molded rubber gaskets incl.	Coperchio punterie con viti centrali.	Fixation par vis centrale
	REC17930	835096	Tornillo en el canto.	Rim bolt desing	Coperchio punterie con viti nel perimetro.	Fixation par 4 vis latérales.
	REF	RETÉN DISTRIBUCIÓN	OIL SEAL TIMING COVER	PARAOLIO DISTRIBUZIONE	JOINT D'HUILE DE DISTRIBUTION	
	REC3853341		Reten contrarrotación. Motor sin tapa distribución de plástico.	Reverse rotation oil seal. Engines without plastic timing cover.	Paraolio controrotante. Motore senza carter distribuzione in plastica.	Joint contre rotation pour moteur sans carter de distribution en plastique.

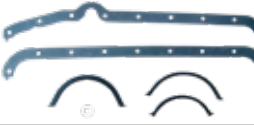







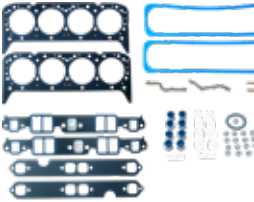
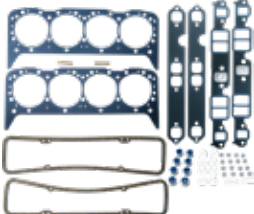
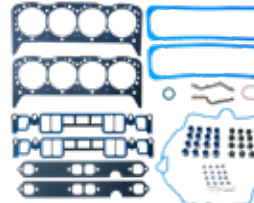



5.0L 307 OHV V8 (210, 215, 225, 230, 235, 245 HP)

	REF	CULATA	CYLINDER HEAD	TESTATA	CULASSE	
	REC17030	3853380	Se necesitan dos	2 required	Ne servono 2	2 sont nécessaires
	REC17230		Kit Juntas Superior Incluye retenes válvulas.	GASKET HEAD SET Premium valve stem seals incl.	KIT PARTE ALTA Incluso tenuta valvole	KIT DE JOINTS SUPERIEURS Comprend les joints de valve.
	REF	INFERIOR	CONVERSION	PARTE BASSA	PARTIE BASSE	
	REC17120		Retén de 2 piezas y junta cárter de 4 piezas	Two-piece rear main bearing seal & 4	Paraolio posteriore in 2 pz e guarnizione coppa in 4 pz.	Joint d'huile en 2 parties et joint de carter en 4 parties.

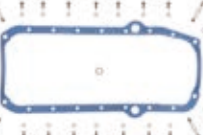









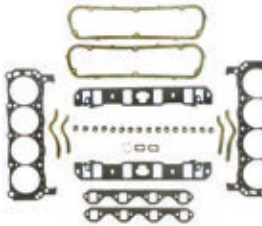

REF	COLECTOR ADMISION-ESCAPE	MANIFOLD INTAKE & EXHAUST	COLLETTORE ASPIRAZIONE-SCARICO	COLLECTEUR ADMISION ET ECHAPPEMENT
 REF REC17320	Kit junta admisión-escape.	Intake-exhaust gasket set.	Kit guarnizioni aspirazione - scarico.	Kit joints d'admission.
 FEL17420	KIT JUNTAS COLECTOR -ESCAPE	OIL PAN - EXHAUST GASKET SET	KIT GUARNIZIONE COPPA OLIO - SCARICO	KIT JOINTS COLLECTEUR D'ÉCHAPPEMENT
REF	CARTER	OIL PAN	COPPA DELL'OLIO	CARTER
 REC17980	855729 Varilla aceite a babor con retén trasero de 2 piezas y junta cárter de 4 piezas.	Port dipstick with 2-piece rear main bearing seal & 4-piece oil pan gasket.	Asticella olio a SINISTRO con praolio	Jauge d'huile côté bâbord avec joint d'huile arrière en 2 parties et joint de carter en 4 parties.
REF	RETÉN TRASERO CIGÜENAL	Crankshaft rear seal	PARAOLIO POSTERIORE ALBERO MOTORE	JOINT D'HUILE DE VILEBREQUIN ARRIERE
 FEL17725	Retén Contrarrotación de 2 piezas	Split seal Rev. rotation, rubber; 2-piece	Controrotazione in 2 pz.	Joint d'huile contre-rotatif en 2 parties
REF	TAPA VÁLVULAS	VALVE COVER	COPERCHIO VALVOLE	COUVERCLE DE SOUPAPE
 REC17930	835096 Tornillo lateral	Rim bolt desing	Coperchio punterie con viti nel perimetro.	Vis latérale
REF	RETÉN DISTRIBUCIÓN	OIL SEAL TIMING COVER	PARAOLIO DISTRIBUZIONE	JOINT D'HUILE DE DISTRIBUTION
 REC3853341	Reten contrarrotación. Motor sin tapa distribución de plástico.	Reverse rotation oil seal. Engines without plastic timing cover.	Paraolio controrotante. Motore senza carter distribuzione in plastica.	Joint contre rotation pour moteur sans carter de distribution en plastique.

5.7L V8, 250 (215, 220, 250, 260, 270, 290 HP), 250 KING COBRA (235, 270 HP), 260 (250, 260, 270, 290 HP)

REF	CULATA	CYLINDER HEAD	TESTATA	CULASSE
 REC17030	Se necesitan dos	2 required	Ne servono 2	2 sont nécessaires
 REC17214	Tornillo centro tapa válvulas. Incluye retenes válvulas.	With center bolt desing valve covers. Premium valve stem seals included.	Viti coperchio punterie al centro. Include paraoli valvole.	Cache culbuteur avec les vis centrales. Comprend les joints de queue de soupapes.
 REC17230	Tornillo en el lateral tapa válvulas. Incluye retenes válvulas.	Rim bolt desing valve covers. Premium valve stem seals included.	Viti coperchio punterie nel perimetro. Include paraoli valvole.	Cache culbuteur avec les vis laterales. Comprend les joints de queue de soupapes.
 REC17232	Gen+ con juntas plástico colector admisión, con juntas tapa válvulas. Retenes válvulas incluidos.	GEN+ w/ plastic intake manifold gskts. valve cover gskts. incl; Premium valve stem seals incl.	Gen+ con guarnizione aspirazione in plastica con guarnizione in goma. Includi paraolio valvole.	Gen+ avec joints de collecteur d'admission en plastique, avec joints de cache-soupapes. Joints de soupape inclus.





REF		INFERIOR	CONVERSION	PARTE BASSA	PARTIE BASSE
	REC17125	Retén de 1 pieza y junta cárter de 1 pieza Incluye junta de cárter.	One-piece rear main bearing seal & 1 piece oil pan gasket. Oil pan gasket included.	Paraolio in 1 peze e guarnizione coppa in 1 peze. Include paraolio coppa.	Joint spi 1 pièce. Joint de carter 1 pièce. Comprend le Joint spi.
	FEL17124	Con tapa de distribución de plástico, retén trasero de 1 pieza y junta cárter de 1 pieza. Junta de cárter incluida.	Eng. with plastic timing cover, 1 piece rear main bearing seal & 1 piece oil pan gskt. oil pan gskt incl.	Carter distribuzione in plastica, paraolio posteriore in 1 pz e guarnizione coppa olio in 1 pz.	Avec couvercle de distribution en plastique, joint arrière monobloc et joint de carter monobloc. Joint de carter inclus.
	REC17120	Retén de 2 piezas y junta cárter de 4 piezas	Two-piece rear main bearing seal & 4 pieces oil pan gasket.	Paraolio in 2 peze e guarnizione coppa in 4 pezi.	Joint spi 2 pièces et joint de carter 4 pièces.
REF		COLECTOR ADMISION-ESCAPE	MANIFOLD INTAKE & EXHAUST	COLLETORE ASPIRAZIONE-SCARICO	COLLECTEUR ADMISSION ET ÉCHAPPEMENT
	REC17320	KIT JUNTAS ADMISION-ESCAPE Excepto GEN+ con juntas de admisión de plástico.	INTAKE-EXHAUST GASKET SET Excl. GEN+ eng. w/ plastic intake gaskets.	KIT GUARNIZIONI ASPIRAZIONE Eccetto Gen+ guarnizione in plastica	KIT DE JOINTS ADMISSION-ÉCHAPPEMENT Sauf GEN+ avec joints d'admission en plastique.
	FEL17420	KIT JUNTAS COLECTOR -ESCAPE	OIL PAN - EXHAUST GASKET SET	KIT GUARNIZIONE COPPA OLIO - SCARICO	KIT JOINTS COLLECTEUR D'ÉCHAPPEMENT
REF		CARTER	OIL PAN	COPPA DELL'OLIO	CARTER
	REC17982	3856138 Junta cárter 1 pieza. Junta de cárter incluida.	1 piece oil pan gasket. Molded rubber oil pan gasket included.	Guarnizione in 1 pz. Guarnizione coppa included.	Joint de carter 1 pièce.
	FEL17983	Junta 1 pieza. Para motores con retén trasero de 2 piezas.	1 piece molded rubber gasket for engines with Two-piece rear main bearing sea.	Guarnizione in 1 pz, paraolio posteriore in 2 px.	Joint de carter 1 pièce pour moteurs avec Joint spi arrière 2 pièces.
	REC17980	855729 Varilla aceite de BABOR con retén trasero de 2 piezas y junta cárter de 4 piezas.	PORT dipstick with 2-piece rear main bearing seal & 4-piece oil pan gasket.	Asticella olio a SINISTRO con paraolio posteriore in 2 pz. e guarnizione coppa da 4 pz.	Jauge d'huile à BABORD avec Joint spi arrière en 2 pièces et joint de carter en 4 pièces.
	REC17981	Varilla aceite de ESTRI-BOR con retén trasero de 2 piezas y junta cárter de 4 piezas.	STARBOARD dipstick with 2-piece rear main bearing seal & 4-piece oil pan gasket	Asticella olio DESTRO con paraolio posteriore in 2 pz e guarnizione coppa da 4 pz.	Jauge d'huile à TRIBORD avec Joint spi arrière en 2 pièces et joint de carter en 4 pièces.
REF		RETÉN TRASERO CIGÜENAL	Crankshaft rear seal	PARAOLIO POSTERIORE ALBERO MOTORE	JOINT D'HUILE DE VILEBREQUIN ARRIÈRE
	FEL17725	Retén Contrarrotación de 2 piezas	Split seal Rev. rotation, rubber; 2-piece	Controrotazione in 2 pz.	Joint d'huile contre-rotatif en 2 parties
REF		TAPA VÁLVULAS	VALVE COVER	COPERCHIO VALVOLE	COUVERCLE DE SOUPAPE
	REC17931	3852687 Tornillo centro tapa válvulas con juntas.	Molded rubber gaskets incl.	Coperchio punterie con viti centrali.	Fixation par vis centrale
	REC17930	835096 Tornillo en el canto.	Rim bolt desing	Coperchio punterie con viti nel perimetro.	Fixation par 4 vis latérales.
REF		RETÉN DISTRIBUCIÓN	OIL SEAL TIMING COVER	PARAOLIO DISTRIBUZIONE	JOINT D'HUILE DE DISTRIBUTION
	REC3853341	Reten contrarrotación Motor sin tapa distribución de plástico.	Reverse rotation oil seal Engines w/o plastic timing cover.	Paraolio controrrotante. Motore senza carter distribuzione in plastica.	Joint de contre-rotation du moteur sans cache-soupape en plastique.

5.8L (210, 215, 235 HP), 5.8L COBRA (240 HP), 250HP, 351 KING COBRA (260 HP)

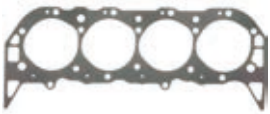
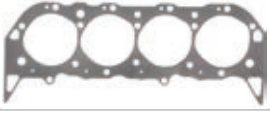
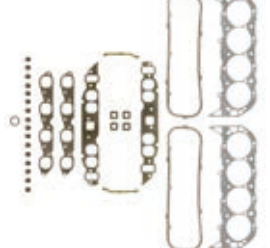
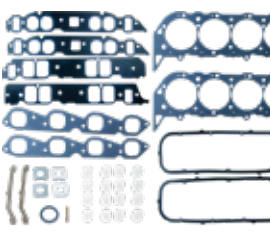
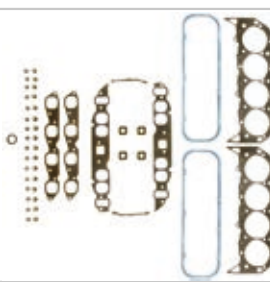
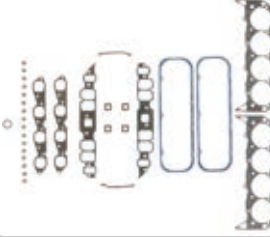
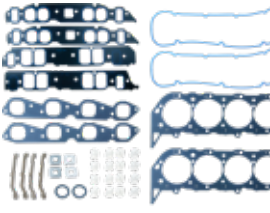
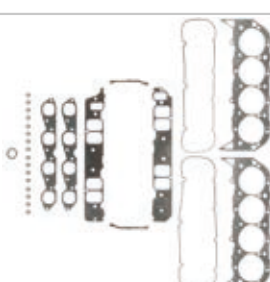
REF	CULATA	CYLINDER HEAD	TESTATA	CULASSE	
 FEL17060	Se necesitan dos	2 required	Necessarie 2	Deux sont nécessaires	
 FEL17261	Con tapa válvulas de aluminio. Incluye retenes de válvulas.	With cast aluminum valve covers. Premium valve stem seals included.	Con coperchio punterie in alluminio. Include paraolio valvole.	Avec le cache culbuteur en Aluminium. Comprend les joints de queue de soupape.	KIT DE JOINTS SUPERIEURS Avec couvercle de valves en AL. Comprend les joints de valve.
 FEL17260	Incluye retenes de válvulas.	Premium valve stem seals included.	Include paraoli valvole.	Comprend les joints de queue de soupape.	
REF	INFERIOR	CONVERSION	PARTE BASSA	PARTIE BASSE	
 FEL17166	KIT JUNTAS INFERIOR Retén de una pieza y 1 pieza junta cárter, incluye junta de cárter de goma.	CONVERSION GASKET SET With 1 piece rear main bearing seal Et 1 piece oil pan gasket; rubber oil pan gasket included	KIT PARTE BASSA Paraolio in 1 pz e guarnizione coppa dell'olio in 1 pz.		
 FEL17165	KIT JUNTAS INFERIOR Gene V con retén trasero de una pieza y junta cárter de 1 pieza. Junta cárter de goma incluida.	CONVERSION GASKET SET Gene V w/one piece rear main bearing seal Et one piece oil pan gskt. Rubber oil pan gasket incl.	KIT PARTE BASSA Gen V con paraolio posteriore di 1 pz e guarnizione coppa in 1 pz.	KIT JOINTS	
 REC17146	KIT JUNTAS INFERIOR Retén de 2 piezas y 4 piezas junta cárter	CONVERSION GASKET SET With 2 piece rear main bearing seal Et 4 piece oil pan gasket	KIT PARTE BASSA Paraolio in 2 pz e guarnizione coppa in 4 pz.		
REF	COLECTOR ADMISION-ESCAPE	MANIFOLD INTAKE & EXHAUST	COLLETORE ASPIRAZIONE-SCARICO	COLLECTEUR ADMISION ET ÉCHAPPEMENT	
 FEL17360	Kit junta admisión	Intake gasket set	Kit guarnizioni aspirazione	Kit joints d'admission	KIT JOINTS ADMISION
 REC3852455	Junta escape	Exhaust gasket	Guarnizione scarico	Joints collecteur d'échappement	KIT JOINTS D'ÉCHAPPEMENT
REF	CARTER	OIL PAN	COPPA DELL'OLIO	CARTER	
 FEL17996	KIT JUNTAS	GASKET SET	KIT GUARNIZIONE	KIT JOINTS	
 FEL17998	1 pieza junta cárter incluye junta de goma.	With 1 piece oil pan gasket. Rubber gasket included.	Guarnizione coppa in 1 pz.		
REF	TAPA VÁLVULAS	VALVE COVER	COPERCHIO VALVOLE	COUVERCLE	
 FEL17945	835096 Con tapa de válvulas de acero	With iron valve cover	Con coperchio valvole in acciaio	Cache culbuteur en acier	
 FEL17946	3852687 Con tapa válvulas de aluminio.	With cast aluminium valve covers.	Con coperchio valvole in alluminio.	Cache culbuteur en Aluminium	

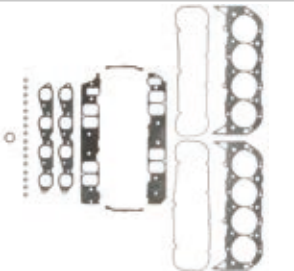
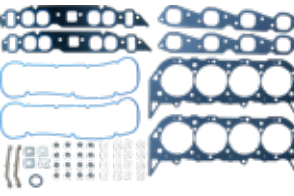
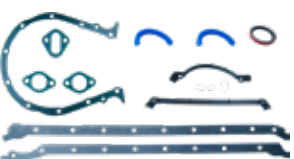
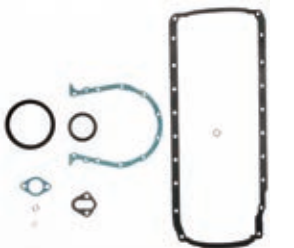

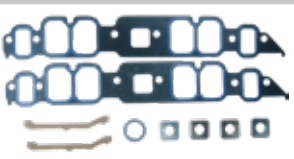
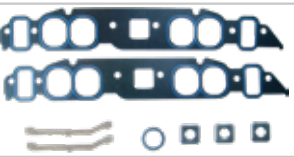
7.4 L, 454 (330, 335 HP GEN IV)
HIGH OUTPUT KING COBRA (370 HP GEN IV, 330 HP GEN V),
454 KING COBRA (275, 295, 310 HP GEN IV, 295, 310 GEN V)

	REF	CULATA	CYLINDER HEAD	TESTATA	CULASSE
	REC17040	Gene IV Se necesitan dos	Gene IV 2 required	Gene IV Necessarie 2	Gene IV Deux sont nécessaires
	REC17042	Gene IV & V. Se necesitan 2.	Gene IV & V. 2 required	Gene IV e V. Necessarie 2	Gène IV & V. 2 requis.
	REC17240	Gen IV exc. H.O. con admisión ovalada. Se incluye retenes de válvula.	Gen IV exc. H.O. with oval intake ports. Premium valve stem seals included.	Gen IV escluso H.O. con aspirazione ovale. Inclusi paraoli valvole.	Gen IV exc. H.O. avec admission ovale. Joints de queue de soupape inclus.
	REC17241	Gene IV solo H.O. Se incluye retenes de válvula	Gen IV only H.O.premium valve stem seals incl.	Gene IV solo H.O. Inclusi paraoli valvole.	Gene IV uniquement H.O. Joints de soupape inclus
	FEL17244	Gen V Excepto EFI o H.O.Juntas tapa válvula de goma.Se incluye retenes de válvula.	Gen V premium excl. EFI or H.O. Rubber valve cover & valve stem seals included.	Gen V escluso EFI o H.O. inclusi paraoli valvole.	Gen V sauf EFI et H.O. joints de couvre- soupapes et joints en caoutchouc inclus.
	FEL17245	Gen V con retén trasero de una pieza y junta cárter de 1 pieza. Junta cárter incluida.	Gen V with one piece rear main bearing seal & one piece oil pan gasket. Oil pan gasket included.	Gen V con paraolio posteriore in 1 pz. e guarnizione coppa dell'olio in 1 pz.	Gen V avec joint arrière en 1 pièce et joint de carter en 1 pièce. Joint de carter inclus.
	REC17242	Gen V EFI y H.O. Se incluye retenes de válvula. Gen VI. EFI y H.O. juntas de goma de tapa válvulas y retenes incluidos	Gen V. EFI or H.O. ; premium valve stem seals incl. Gen VI, EFI & H.O. molded rubber valve cover gaskets and premium valve stem seals incl.	Gen V EFI e H.O. Include paraoli valvole. Gen VI, EFI e H.O., guarnizione coperchio punterie e paraoli inclusi.	Gen V EFI et H.O. Joint de soupape inclus. Gen VI. EFI et H.O. joints de couvre-soupapes et joints en caoutchouc inclus.
	FEL17205	Gen VI sólo EFI Juntas de tapa válvulas y retenes incluidos.	Gen VI, EFI only, valve cover gaskets and premium valve stem seals incl.	Gen VI, solo EFI guarnizione rettangolare, guarnizione coperchio punterie e paraoli inclusi.	Gen V EFI uniquement. Joints de cache culbuteur et joints de queue de soupape inclus.

	FEL17205	Kit Juntas Superior Gene VI sólo EFI Juntas de tapa válvulas y retenes incluidos.	GASKET HEAD SET Gen VI, EFI only, valve cover gaskets and premium valve stem seals incl.	KIT PARTE ALTA Gene VI, solo EFI guarnizione rettangolare, guarnizione coperchio punterie e paraoli inclusi.	KIT DE JOINTS SUPÉRIEURS Gene VI EFI uniquement Joints de couvre-souape et joints inclus.
	REC17243	Gene VI sólo H.O. Se incluye retenes de válvula. Juntas tapa válvula de goma.	Gen VI only H.O. Rubber valve cover & premium valve stem seals incl.	Gene VI solo H.O. Inclusi paraoli valvole.	KIT DE JOINTS SUPÉRIEURS Gene VI re Joints de couvre-souape et joints inclus.
	REF	INFERIOR	CONVERSION	PARTE BASSA	PARTIE INFÉRIEUR
	REC17140	Gene IV con retén trasero de dos piezas y junta cárter de 4 piezas.	Gene IV w/two piece rear main bearing seal & four piece oil pan gasket.	Gene IV con paraolio posteriore in 2 pz. e guarnizione coppa dell'olio in 4 pz.	Gene IV avec joint arrière en deux parties et joint de carter en 4 parties.
	FEL17145	Gene V con retén trasero de una pieza y junta cárter de 1 pieza. Junta cárter incluida.	Gene V w/one piece rear main bearing seal & one piece oil pan gasket. oil pan gasket. incl.	Gene V con paraolio posteriore in 1 pz. e guarnizione coppa dell'olio in 1 pz.	Gene V avec joint arrière monobloc et joint de carter monobloc. Joint de carter inclus.
	REC17146	Gene VI con retén trasero de una pieza y junta cárter de 1 pieza. Junta cárter incluida.	Gene VI w/one piece rear main bearing seal & one piece oil pan gasket. incl.	Gene VI con paraolio posteriore in 1 pz. e guarnizione coppa dell'olio in gomma in 1 pz.	Gene VI avec joint à lèvres arrière en une seule pièce et joint de carter en une seule pièce. Joint de carter inclus.
	REF	COLECTOR ADMISIÓN-ESCAPE	MANIFOLD INTAKE & EXHAUST	COLLETTORE ASPIRAZIONE-SCARICO	COLLECTEUR ADMISION ET ÉCHAPPEMENT
	REC17341	KIT JUNTA ADMISIÓN Gene IV, V y VI sólo H.O. con admisión rectangular. Gene IV, excl. H.O. con admisión rectangular.	INTAKE GASKET SET Gene IV, V & VI, H.O. only w/rectangular intake ports Gene IV excl. H.O. w/rect. intake ports	KIT GUARNIZIONI ASPIRAZIONE Gene IV, V e VI solo H.O. con aspirazione rettangolare Gene IV escluso H.O. con aspirazione rettangolare	KIT DE JOINTS D'ADMISSION Gènes IV, V et VI uniquement H.O. avec admission rectangulaire. Gene IV, excl. H.O. avec admission rectangulaire.
	REC17340	KIT JUNTA ADMISIÓN Gene IV, excl. H.O. con admisión oval. Gene V y VI exc. EFI y H.O. con admisión ovalada.	INTAKE GASKET SET Gene IV excl. H.O. w/oval intake ports Gene V & VI, excl. EFI & H.O. w/oval intake ports	KIT GUARNIZIONI ASPIRAZIONE Gene IV escluso H.O. con aspirazione ovale. Gene V e VI escluso EFI e H.O. con aspirazione ovale	KIT DE JOINTS D'ADMISSION Gene IV, excl. H.O. avec prise ovale. Gène V et VI exc. EFI et H.O. avec admission ovale.
	REC17342	KIT JUNTA ADMISIÓN Gene V y VI sólo EFI	INTAKE GASKET SET Gene V & VI, EFI only	KIT GUARNIZIONI ASPIRAZIONE Gene V e VI, solo EFI	KIT DE JOINTS D'ADMISSION Gene V et VI EFI uniquement
	REC27-46820 3852472	KIT JUNTA ESCAPE Gene IV, V y VI.	EXHAUST GASKET SET Gene IV, V & VI	KIT GUARNIZIONI SCARICO Gene IV, V e VI	KIT DE JOINTS D'ÉCHAPPEMENT Gène IV, V et VI.

REF	RETÉN TRASERO CIGÜENAL	Crankshaft rear seal	PARAOLIO POSTERIORE ALBERO MOTORE	JOINT D'HUILE DE VILEBREQUIN ARRIERE	
	REC26-14756	Gene IV Retén Contrarrotación dos piezas	Gene IV Reverse rotation oil seal Two-pieces	Gene IV Controrotante in 2 pz.	Gene IV Joint d'huile contre-rotatif en deux parties
REF	TAPA VÁLVULAS	VALVE COVER	COPERCHIO VALVOLE	COUVERCLE SOUPAPES	
	REC17935 856626	Gene IV	Gene IV	Gene IV	Gene IV
	FEL17936	KIT JUNTA TAPA VÁLVULAS Gen V solo EFI Juntas de goma incluidas.	GASKET SET Gene V EFI only molded rubber gaskets incl.	GUARNIZIONE COPERCHIO PUNTERIE Gen V solo EFI Kit tenuta inclusa	KIT JOINTS DE COUVERCLE DE SOUPAPE Gen V seulement EFI. Comprend des joints en caoutchouc.
	REC17937 3853513	Gene V & VI	Gene V & VI	Gene V e VI	Gene V et VI

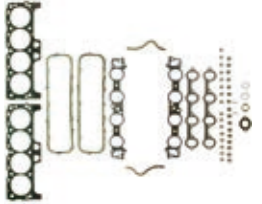
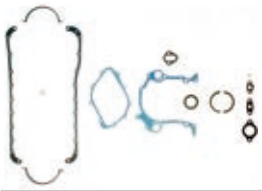
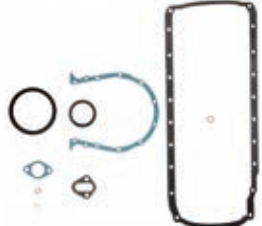
7.5 L, V8, 460 KING COBRA (295, 340 HP)







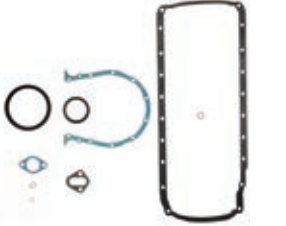

REF	CULATA	CYLINDER HEAD	TESTATA	CULASSE	
FEL17068	JUNTA CULATA Se necesitan dos	CYLINDER HEAD 2 required	GUARNIZIONE TESTATA Necessarie 2	JOINT DE CULASSE Deux sont nécessaires	
	FEL17268	KIT JUNTAS CULATA Se incluye retenes de válvula	CYLINDER HEAD SET Premium valve stem seals included.	KIT GUARNIZIONE TESTATA Si incluyen paraoli valvole	KIT JOINTS DE CULASSE Comprend joints de valve.
REF	INFERIOR	CONVERSION	PARTE BASSA	PARTIE INFÉRIEUR	
	FEL17168	KIT JUNTAS INFERIOR Retén trasero de 2 piezas y junta cárter de 4 piezas.	CONVERSION GASKET SET 2 piece rear main bearing seal & 4 piece oil pan gasket.	KIT PARTE BASSA Paraolio posteriore in 2 pz e guarnizione coppa in 4 pz.	Gene IV avec joint arrière en deux parties et joint de carter en 4 parties.
	FEL17169	KIT JUNTAS INFERIOR con retén trasero de 2 piezas y junta cárter de 1 pieza. Junta cárter de goma incluida.	CONVERSION GASKET SET 2 piece rear main bearing seal & 1 piece oil pan gasket rubber oil pan gasket incl.	KIT PARTE BASSA paraolio posteriore di 2 pz e guarnizione coppa in 1 pz.	Gene V avec joint arrière monobloc et joint de carter monobloc. Joint de carter inclus.
REF	COLECTOR ADMISIÓN-ESCAPE	MANIFOLD INTAKE & EXHAUST	COLLETORE ASPIRAZIONE-SCARICO	COLLECTEUR ADMISSION ET ÉCHAPPEMENT	
	FEL17368	JUNTA ADMISIÓN 4 piezas	INTAKE GASKET 4 piece	GUARNIZIONE ASPIRAZIONE 4 pz	KIT DE JOINTS D'ADMISSION 4 pièces
	FEL17468	JUNTA ESCAPE	EXHAUST GASKET	GUARNIZIONE SCARICO	KIT DE JOINTS D'ADMISSION

REF	TAPA VÁLVULAS	VALVE COVER	COPERCHIO VALVOLE	COUVERCLE SOUPAPES
FEL17947	KIT JUNTAS	GASKET SET	KIT GUARNIZIONI	KIT JOINTS

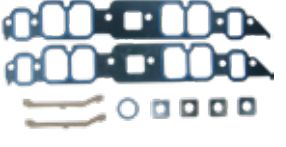
REF	CARTER	OIL PAN	COPPA DELL'OLIO	CARTER
FEL17994	JUNTA CARTER 1 pieza, incluye junta de goma	GASKET OIL PAN 1 piece oil pan gasket. Rubber gasket included.	GUARNIZIONE 1 pz, guarnizione in gomma inclosa	JOINT DE CARTER 1 pièce avec joint en caoutchouc

8.2 L, 502 KING COBRA (375 HP GEN IV, 375 HP GEN V)







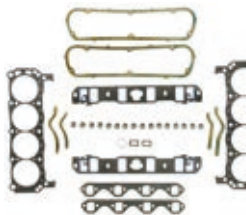

REF	CULATA	CYLINDER HEAD	TESTATA	CULASSE
FEL17049	JUNTA CULATA Gene IV, V & VI sólo H.O. super medida. Se necesitan 2.	CYLINDER HEAD Gene IV, V & VI H.O. only super bore 2 required	GUARNIZIONE TESTATA Gene IV, V & VI solo H.O. maggiorata. Necessarie 2	JOINT CULATA Gene IV, V & VI seulement H.O. super taille. 2 sont nécessaires.
REC17048	JUNTA CULATA Gene IV, V & VI .Se necesitan 2.	CYLINDER HEAD Gene IV, V & VI. 2 required	GUARNIZIONE TESTATA Gene IV, V e VI. necessita 2	JOINT CULATA Gene IV, V & VI. 2 nécessaire.
REC17248	KIT JUNTAS SUPERIOR Gene IV. Se incluye retenes de válvula.	GASKET HEAD SET Gene IV. premium valve stem seals incl.	KIT PARTE ALTA Gene IV. Se incluye paraolio valvole.	KIT DE JOINTS SUPÉRIEURS Gene IV. Joints de soupape inclus.
REC17248	KIT JUNTAS SUPERIOR Gene V exc. EFI. Se incluye retenes de válvula y juntas tapa válvulas.	GASKET HEAD SET Gene V exc. EFI; premium valve stem seals & valve cover gskts.incl.	KIT PARTE ALTA Gene IV escluso EFI. Include paraolio e guarnizione del coperchio valvola	KIT DE JOINTS SUPÉRIEURS GENE V exc. EFI. Les joints de soupape et les joints de couvercle de soupape sont inclus.
REC17207	KIT JUNTAS SUPERIOR Gene V solo EFI. Se incluye retenes de válvula y juntas tapa válvulas.	GASKET HEAD SET Gene V EFI only; premium valve stem seals & valve cover gskts. incl.	KIT PARTE ALTA Gene V solo EFI. Include paraolio e guarnizione del coperchio valvola	KIT DE JOINTS SUPÉRIEURS Gene V EFI uniquement. Les joints de soupape et les joints de couvercle de soupape sont inclus.
REC17207	KIT JUNTAS SUPERIOR Gene VI solo EFI. Se incluye retenes de válvula y juntas tapa válvulas	GASKET HEAD SET Gene VI EFI only; premium valve stem seals & valve cover gskts. incl.	KIT PARTE ALTA Gene VI solo EFI. Include paraolio e guarnizione del coperchio valvola	KIT DE JOINTS SUPÉRIEURS Gene VI EFI uniquement. Les joints de soupape et les joints de couvercle de soupape sont inclus.
REF	INFERIOR	CONVERSION	PARTE BASSA	PARTIE BASSE
REC17140	Gene IV con retén trasero de dos piezas y junta cárter de 4 piezas.	Gene IV w/two piece rear main bearing seal & four piece oil pan gasket.	Gene IV con paraolio posteriore in 2 pz. e guarnizione coppa dell'olio in 4 pz.	Gene IV avec joint arrière en deux parties et joint de carter en 4 parties.

	FEL17145	Gene V con retén trasero de una pieza y junta cárter incluida.	Gene V w/one piece rear main bearing seal & one piece oil pan gasket. oil pan gasket. incl.	Gene V con paraolio posteriore in 1 pz. e guarnizione coppa dell'olio in 1 pz.	Gene IV avec joint arrière en deux parties et joint de carter en 4 parties.
	REC17146	Gene VI con retén trasero de una pieza y junta cárter incluida.	Gene VI w/one piece rear main bearing seal & one piece oil pan gasket. oil pan gasket. incl.	Gene VI con paraolio posteriore in 1 pz. e guarnizione coppa dell'olio in gomma in 1 pz.	Gene VI avec joint arrière monobloc et joint de carter inclus.
	REF	COLECTOR ADMISION-ESCAPE	MANIFOLD INTAKE & EXHAUST	COLLETTORE ASPIRAZIONE-SCARICO	COLLECTEUR ADMISION ET ECHAPPEMENT
	FEL17342	JUNTA ADMISION Gene V & VI solo EFI	INTAKE GASKET Gene V & VI only EFI	GUARNIZIONE ASPIRAZIONE Gene V & VI solo EFI	JOINT ADMISION Gene V et VI seulement EFI
	REC17341	KIT JUNTA ADMISION Gene IV, V y VI sólo H.O. con admisión rectangular. Gene IV, excl. H.O. con admisión rectangular.	INTAKE GASKET SET Gene IV, V & VI, H.O. only w/rectangular intake ports Gene IV excl. H.O. w/rect. intake ports	KIT GUARNIZIONI ASPIRAZIONE Gene IV, V e VI solo H.O. con aspirazione rettangolare Gene IV escluso H.O. con aspirazione rettangolare	KIT DE JOINTS D'ADMISSION Gènes IV, V et VI uniquement H.O. avec admission rectangulaire. Gene IV, excl. H.O. avec admission rectangulaire.
	REC27-46820	KIT JUNTA ADMISION Gene IV, excl. H.O. con admisión oval. Gene V y VI exc. EFI y H.O. con admisión ovalada.	INTAKE GASKET SET Gene IV excl. H.O. w/oval intake ports Gene V & VI, excl. EFI & H.O. w/oval intake ports	KIT GUARNIZIONI ASPIRAZIONE Gene IV escluso H.O. con aspirazione ovale. Gene V e VI escluso EFI e H.O. con aspirazione ovale PARAOLIO POSTERIORE ALBERO MOTORE	KIT DE JOINTS D'ADMISSION Gene IV, excl. H.O. avec prise ovale. Gène V et VI exc. EFI et H.O. avec adm ission ovale. JOINT D'HUILE DE VILEBREQUN ARRIERE
	REF	RETÉN TRASERO CIGÜEÑAL	CRANKSHAFT REAR SEAL		
	REC26-14756	Gene IV Retén Contrarrrotación dos piezas	Gene IV Reverse rotation oil seal Two- pieces	Gene IV Controrotante in 2 pz.	Gene IV Joint d'huile contre-rotatif en deux parties
	REF	TAPA VÁLVULAS	VALVE COVER	COPERCHIO VALVOLE	COUVERCLE SOUPPES
	REC17935	Gene IV	Gene IV	Gene IV	Gene IV
	REC17937	Gene V & VI	Gene V & VI	Gene V e VI	Gene V et VI
	REF	CARTER	OIL PAN	COPPA DELL'OLIO	CARTER
	FEL17985	Junta Carter Gene IV Junta de 4 piezas.	GASKET OIL PAN Gene IV with 4 piece oil pan gasket.	GUARNIZIONE Gene IV, 4 pz,	JOINT Gen IV Joint de 4 pièces
	REC17986	Junta Carter 1 pieza, incluye junta de goma	GASKET OIL PAN 1 piece oil pan gasket. rubber gasket included.	GUARNIZIONE 1 pz, guarnizione in gomma inclusa	JOINT 1 pièce avec joint en caoutchouc

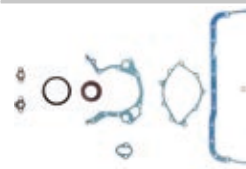
4 CIL 2.3L FORD







REF	COLECTOR ADMISIÓN-ESCAPE	MANIFOLD INTAKE & EXHAUST	COLLETTORE ASPIRAZIONE-SCARICO	COLLECTEUR ADMISION ET ÉCHAPPEMENT
 REC913393	913393 JUNTA ESCAPE	EXHAUST GASKET	GUARNIZIONE SCARICO	JOINT D'ÉCHAPPEMENT

8 CIL 5.0 L (160, 170, 185 HP), 5.0L HIGH OUTPUT (175, 190, 200 HP), 175 HP, 190 HP - FORD 302 (5.0)

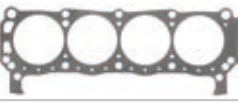
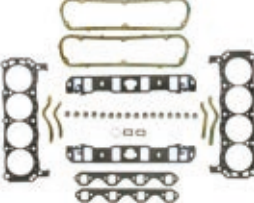
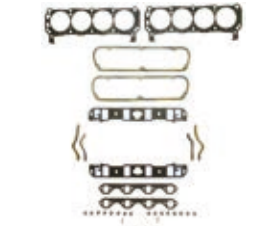
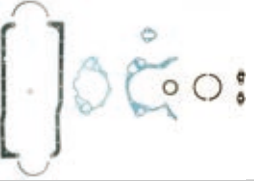
REF	CULATA	CYLINDER HEAD	TESTATA	CULASSE
 FEL17060	Se necesitan dos	2 required	Necessarie 2	Deux sont nécessaires
 FEL17260	Incluye retenes de válvulas.	Premium valve stem seals included.	Include paraoli valvole.	Comprend les joints de queue de soupape.
 FEL17261	Con tapa válvulas de aluminio. Incluye retenes de válvulas.	With cast aluminum valve covers. Premium valve stem seals included.	Con coperchio punterie in alluminio. Include paraolio valvole.	Avec le cache culbuteur en Aluminium. Comprend les joints de queue de soupape.
REF	INFERIOR	CONVERSION	PARTE BASSA	PARTIE BASSE
 FEL17161	Retén 1 piezas, 1 pieza junta cárter. Incluye junta de cárter.	1 piece rear main bearing seal & 1 piece oil pan gasket. Rubber oil pan gasket included.	Paraolio in 1 pz, 1 pz guarnizione coppa dell'olio. Include guarnizione coppa.	Joint spi 1 pièce Joint de carter 1 pièce. Comprend le joint de carter.
 FEL17160	Retén 2 piezas, 4 piezas junta cárter.	2 piece rear main bearing seal & 4 piece oil pan gasket.	Paraolio in 2 pz, 4 pz guarnizione coppa dell'olio.	Joint spi 2 pièces Joint de carter 4 pièces.
REF	COLECTOR ADMISIÓN-ESCAPE	MANIFOLD INTAKE & EXHAUST	COLLETTORE ASPIRAZIONE-SCARICO	COLLECTEUR ADMISION ET ÉCHAPPEMENT
 FEL17360	Kit junta admisión	Intake gasket set	Kit guarnizioni aspirazione	Kit joints d'admission
 REC3852455	Junta escape	Exhaust gasket	Guarnizione scarico	Joints collecteur d'échappement
REF	CARTER	OIL PAN	COPPA DELL'OLIO	CARTER
 FEL17995	JUNTA CARTER 4 piezas.	GASKET OIL PAN 4 piece	GUARNIZIONE 4 pz,	JOINT 4 pièce
 FEL17997	JUNTA CARTER 1 pieza	GASKET OIL PAN 1 piece	GUARNIZIONE 1 pz,	JOINT 1 pièce







	REF	RETÉN TRASERO CIGÜEÑAL	CRANKSHAFT REAR SEAL	PARAOLIO POSTERIORE ALBERO MOTORE	JOINT D'HUILE DE VILEBREQUIN ARRIÈRE
	FEL17746	KIT JUNTAS Contrarrotación	GASKET KIT Rev. rotation	KIT GUARNIZIONE. controrotante	KIT JOINTS contro-rotatif
	REF	TAPA VÁLVULAS	VALVE COVER	COPERCHIO VALVOLE	COUVERCLE SOUPPES
	FEL17945	Con tapa de válvulas de acero	With iron valve cover	Con coperchio valvole in acciaio	Cache culbuteur en acier

8 CIL
5.8L (210, 215, 235 HP), 5.8L COBRA (240 HP),
250 HP, 351 KING COBRA (260 HP), FORD 351W

	REF	CULATA	CYLINDER HEAD	TESTATA	CULASSE
	FEL17060	Se necesitan dos	2 required	Necessarie 2	Deux sont nécessaires
	FEL17260	Incluye retenes de válvulas.	Premium valve stem seals included.	Include paraoli valvole.	Comprend les joints de queue de soupape.
	FEL17261	Con tapa válvulas de aluminio. Incluye retenes de válvulas.	With cast aluminum valve covers. Premium valve stem seals included.	Con coperchio punterie in alluminio. Include paraolio valvole.	Avec le cache culbuteur en Aluminium. Comprend les joints de queue de soupape.
	REF	INFERIOR	CONVERSION	PARTE BASSA	PARTIE BASSE
	FEL17165	KIT JUNTAS INFERIOR 4 piezas.	CONVERSION GASKET SET 4 piece oil pan gasket.	KIT PARTE BASSA 4 pz	Gene IV avec joint arrière en deux parties
	FEL17166	KIT JUNTAS INFERIOR 1 pieza	CONVERSION GASKET SET 1 piece	KIT PARTE BASSA 1 pz	KIT JOINTS INFÉRIEUR 1 pièce
	REF	COLECTOR ADMISION-ESCAPE	MANIFOLD INTAKE & EXHAUST	COLLETORE ASPIRAZIONE-SCARICO	COLLECTEUR ADMISSION ET ÉCHAPPEMENT
	FEL17360	Kit junta admisión	Intake gasket set	Kit guarnizioni aspirazione	Kit joints d'admission
	REC3852455	Junta escape	Exhaust gasket	Guarnizione scarico	Joint collecteur d'échappement
	REF	CARTER	OIL PAN	COPPA DELL'OLIO	CARTER
	FEL17996	Junta Carter 4 piezas.	GASKET OIL PAN 4 piece	GUARNIZIONE 4 pz,	JOINT 4 pièce
	FEL17998	Junta Carter 1 pieza	GASKET OIL PAN 1 piece	GUARNIZIONE 1 pz,	JOINT 1 pièce

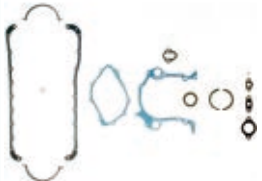
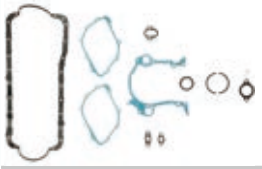
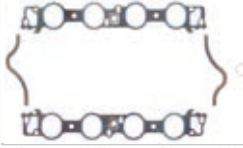
	REF	TAPA VÁLVULAS	VALVE COVER	COPERCHIO VALVOLE	COUVERCLE SOUPPES
	FEL17945	Con tapa de válvulas de acero	With iron valve cover	Con coperchio valvole in acciaio	Cache culbuteur en acier
	FEL17946	Con tapa válvulas de aluminio.	With cast aluminium valve covers.	Con coperchio valvole in alluminio.	Cache culbuteur en Aluminium

**8 CIL
460 KING COBRA (295, 340 HP), FORD 460 (7.5L)**

	REF	CULATA	CYLINDER HEAD	TESTATA	CULASSE
	FEL17068	JUNTA CULATA	CYLINDER HEAD	GUARNIZIONE TESTATA	JOINT CULATA
	FEL17268	KIT JUNTAS Con tapa válvula sellada	GASKET SET Sealed valve cover	KIT GUARNIZIONE Coperchio valvole in acciaio	KIT DE JOINTS SUPÉRIEURS Avec couvercle valves hermétique
	REF	INFERIOR	CONVERSION	PARTE BASSA	PARTIE BASSE
	FEL17168	KIT JUNTAS INFERIOR 4 piezas.	CONVERSION GASKET SET 4 piece oil pan gasket.	KIT PARTE BASSA 4 pz	KIT JOINTS INFÉRIEUR 4 pièces
	FEL17169	KIT JUNTAS INFERIOR 1 pieza	CONVERSION GASKET SET 1 piece	KIT PARTE BASSA 1 pz	KIT JOINTS INFÉRIEUR 1 pièce
	REF	COLECTOR ADMISIÓN-ESCAPE	MANIFOLD INTAKE & EXHAUST	COLLETORE ASPIRAZIONE-SCARICO	COLLECTEUR ADMISION ET ÉCHAPPEMENT
	FEL17368	KIT JUNTA ADMISIÓN	INTAKE GASKET SET	KIT GUARNIZIONE ASPIRAZIONE	KIT DE JOINTS D'ADMISSION
	FEL17468	KIT JUNTA ESCAPE	EXHAUST GASKET SET	KIT GUARNIZIONE SCARICO	KIT DE JOINTS D'ÉCHAPPEMENT
	REF	CARTER	OIL PAN	COPPA DELL'OLIO	CARTER
	FEL17994	Junta Carter 1 pieza	GASKET OIL PAN 1 piece	GUARNIZIONE 1 pz,	JOINT 1 pièce
	REF	TAPA VÁLVULAS	VALVE COVER	COPERCHIO VALVOLE	COUVERCLE SOUPPES
	FEL17947	KIT JUNTAS	GASKET KIT	KIT GUARNIZIONE	KIT JOINTS

SISTEMA DE ESCAPE Y ADMISIÓN EXHAUST & INTAKE SYSTEM

SISTEMA DI SCARICO E ASPIRAZIONE SYSTEME D'ÉCHAPPEMENT ET D'ADMISSION

DESPIECES COLECTORES Y CODOS / MANIFOLDS & ELBOWS PARTS / PARTI COLLETTORI E GOMITI / PIÈCES COLLECTEURS ET COUDES

120HP, 4 CYL. 153CID / 2.5L GM SERIES 400

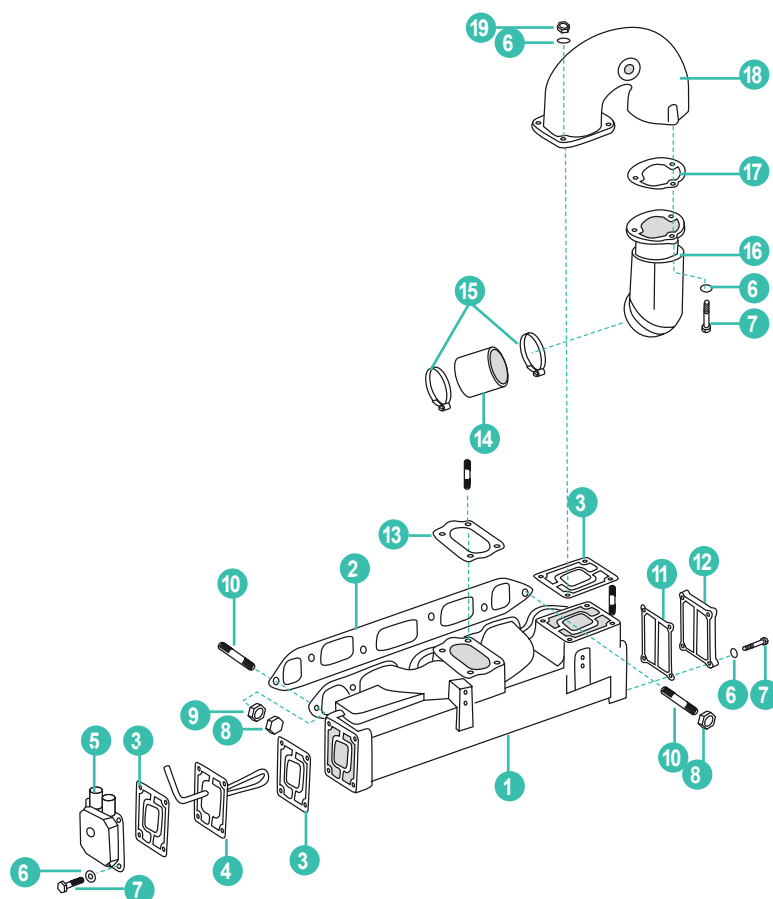

	REF	OEM				
1	BAOMC1-981462	981462	COLECTOR ESCAPE	EXHAUST MANIFOLD ASSEMBLY	COLLETTORE SCARICO	COLLECTEUR D'ÉCHAPPEMENT
2	REC27-52546	311068	JUNTA COLECTOR	GASKET - EXHAUST MANIFOLD	GUARNIZIONE	JOINT DE COLLECTEUR
3	REC311121	311121	JUNTA CODO A TAPA	GASKET - EXHAUST ELBOW AND END CAP	GUARNIZIONE	JOINT COUDE À COUVERCLE
4	BA1-380446	380446	INTERCAMBIADOR DE CALOR	HEAT EXCHANGE ASSEMBLY	SCAMBIATORE DI CALORE	ÉCHANGEUR
5	BA1-910280	910280	TAPA DELANTERA	END CAP - FRONT	COPERCHIO ANTERIORE	COUVERCLE FRONTAL
6	REC13-39107	306470	CIERRE	LOCKWASHER	CHIUSURA	RONDELLE
7	REC317624	552940	TORNILLO	SCREW	VITE	VIS
8	REC11-862903	552938	TUERCA	NUT	DADO	ÉCROU
9	REC13-35048	120177	CIERRE	LOCKWASHER	CHIUSURA	RONDELLE
10	REC16-56826	3852093	PERNO	STUD	PERNO	VIS
11	REC907761	907761	JUNTA TAPA	GASKET - END CAP	GUARNIZIONE	JOINT COUVERCLE
12	BAOMC1-907885	907885	TAPA TRASERA	END CAP - REAR	COPERCHIO POSTERIORE	COUVERCLE ARRIÈRE
13	REC315055	315055	JUNTA CARBURADOR	CARBURETOR GASKET	GUARNIZIONE CARBURATORE	JOINT DE CARBURATEUR
14	REC909371	909371	MANGUITO ESCAPE CODO	EXHAUST HOSE - ELBOW	MANICOTO SCARICO	DURITE D'ÉCHAPPEMENT
15	GS38320	3852604	ABRAZADERA MANGUITO	CLAMP - EXHAUST HOSE	FASCETTA MANICOTTO	COLLIER
16	REC909368	909368	CODO	ELBOW	GOMITO	COUDE
17	REC907764	907764	JUNTA CODO A TAPA	GASKET - ELBOW	GUARNIZIONE	JOINT COUDE À COUVERCLE
18	BAOMC20-980536	980536	CODO ESCAPE	EXHAUST ELBOW ASSEMBLY	GOMITO SCARICO	COUDE D'ÉCHAPPEMENT
19	REC3852142	306422	TUERCA	NUT	DADO	ÉCROU

OMC

RECAMBIOS
MARINOS

120HP, 4 CYL. 153CID / 2.5L GM (1981-86)

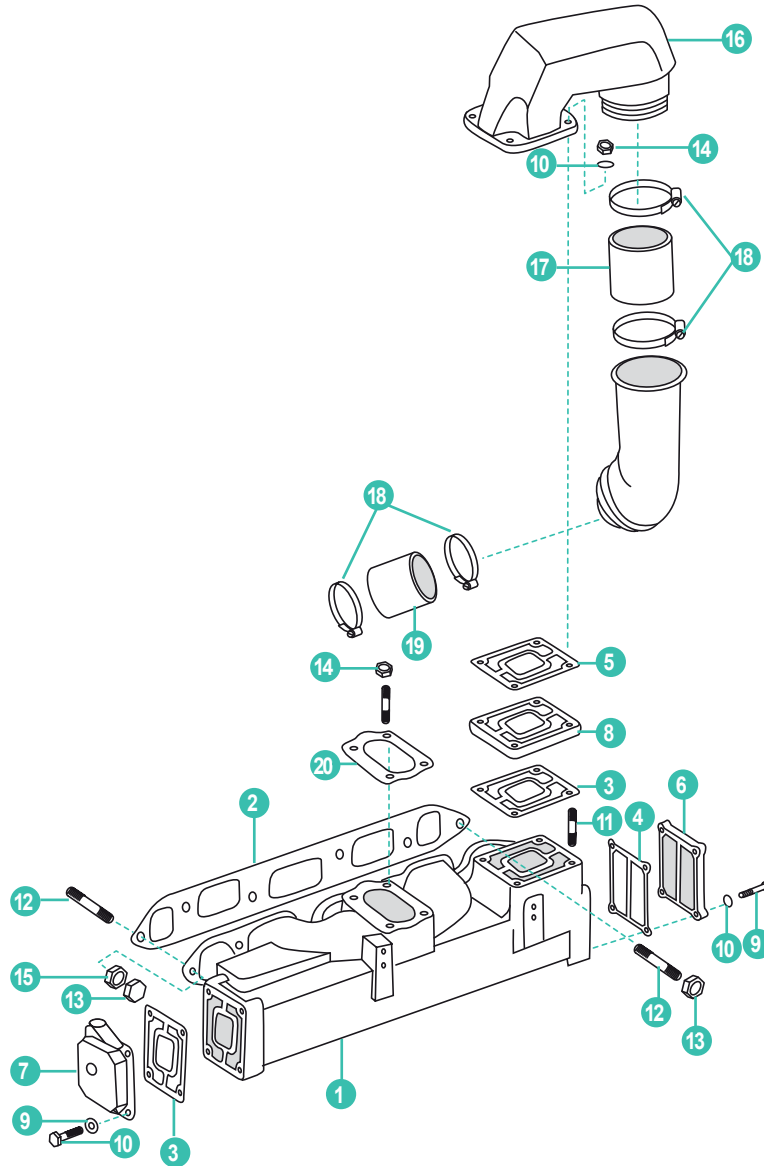

	REF	OEM				
1	BAOMC1-982657	982657	COLECTOR ESCAPE	EXHAUST MANIFOLD ASSEMBLY	COLLETTORE SCARICO	COLLECTEUR D'ÉCHAPPEMENT
2	REC27-52546	311068	JUNTA COLECTOR ESCAPE	GASKET - EXHAUST MANIFOLD	GUARNIZIONE COLLETTORE	JOINT COLLECTEUR
3	REC311121	311121	JUNTA TAPA Y ESPACIADOR	GASKET - END CAP AND SPACER	GUARNIZIONE	JOINT COUVERCLE
4	REC907761	907761	JUNTA TAPA	GASKET - END CAP	GUARNIZIONE	JOINT COUVERCLE
5	REC3850495	3850495	JUNTA CODO ESCAPE	GASKET - EXHAUST ELBOW	GUARNIZIONE SCARICO	JOINT COUDE D'ÉCHAPPEMENT
6	BAOMC1-907885	907885	TAPA TRASERA	END CAP - REAR	COPERCHIO POSTERIORE	COUVERCLE ARRIÈRE
7	BA1-910384	910384	TAPA DELANTERA	END CAP - FRONT	COPERCHIO ANTERIORE	COUVERCLE AVANT
8	BAOMC20-908014	908014	ESPACIADOR	SPACER	DISTANZIALI	ADAPTATEUR POUR COUDE
9	REC317624	552940	TORNILLO	SCREW	VITE	VIS
10	REC13-39107	306470	CIERRE	LOCKWASHER	CHIUSURA	RONDELLE
11	REC910389	910389	PERNO	STUD	PERNO	VIS
12	REC16-56826	120177	PERNO	STUD	PERNO	VIS
13	REC11-862903	552938	TUERCA	NUT	DADO	ÉCROU
14	REC3852142	306422	TUERCA	NUT	DADO	ÉCROU
15	REC13-35048	120177	CIERRE	LOCKWASHER	CHIUSURA	RONDELLE
16	BAOMC20-910380	3850799	CODO ESCAPE	EXHAUST ELBOW ASSEMBLY	GOMITO SCARICO	COUDE D'ÉCHAPPEMENT
17	REC909232	909232	MANGUITO ESCAPE	EXHAUST HOSE	MANICOTO SCARICO	DURITE D'ÉCHAPPEMENT
18	GS38320	3852604	ABRAZADERA	CLAMP	FASCETTA	COLLIER
19	REC909371	909371	MANGUITO ESCAPE	EXHAUST HOSE	MANICOTO SCARICO	DURITE D'ÉCHAPPEMENT
20	REC315055	315055	JUNTA CARBURADOR	GASKET - CARBURATOR	GUARNIZIONE CARBURATORE	JOINT CARBURATEUR

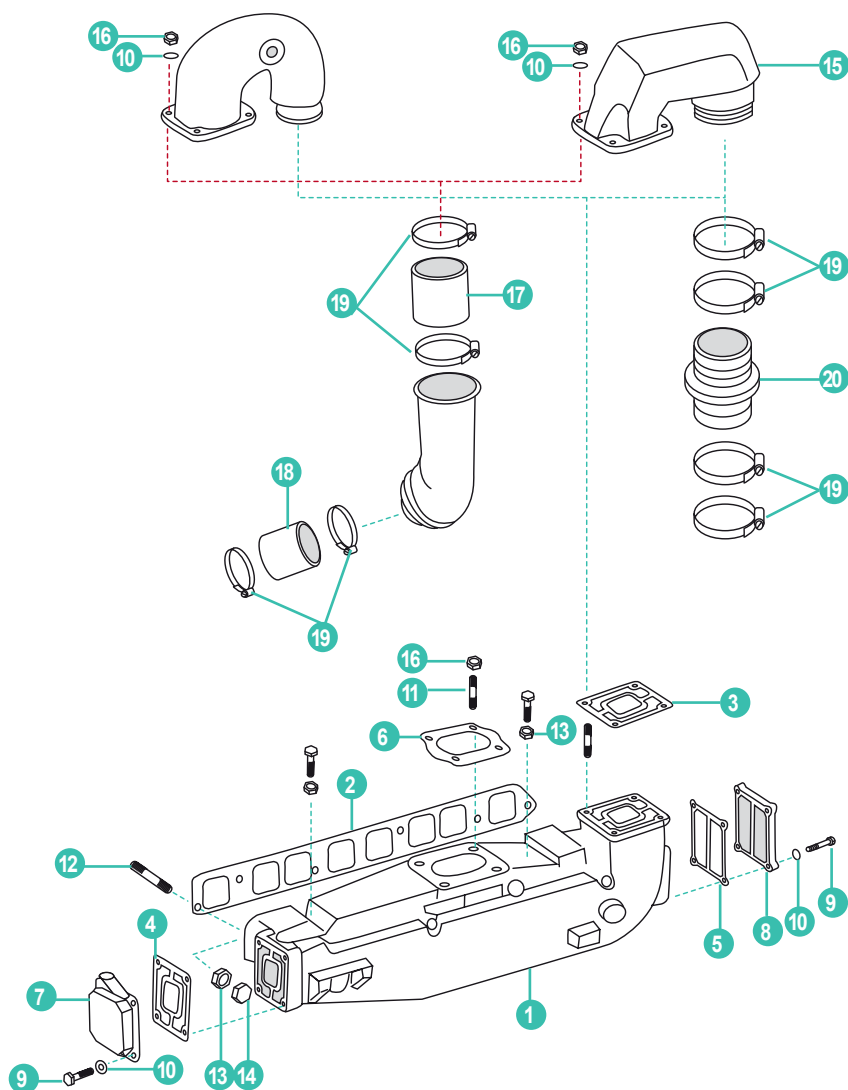

	REF	OEM				
1	BAOMC1-984054	984054	COLECTOR ESCAPE	EXHAUST MANIFOLD ASSEMBLY	COLLETTORE SCARICO	COLLECTEUR D'ÉCHAPPEMENT
2	REC27-53354	908079	JUNTA COLECTOR ESCAPE	GASKET - EXHAUST MANIFOLD	GUARNIZIONE COLLETTORE	JOINT COLLECTEUR
3	REC3850495	3850495	JUNTA CODO	GASKET - EXHAUST ELBOW	GUARNIZIONE GOMITO	JOINT COUDE
4	REC311121	311121	JUNTA TAPA	GASKET - END CAP	GUARNIZIONE COPERCHIO	JOINT COUVERCLE
5	REC907761	907761	JUNTA TAPA	GASKET - END CAP	GUARNIZIONE COPERCHIO	JOINT COUVERCLE
6	REC315055	315055	JUNTA CARBURADOR	GASKET - CARBURETOR	GUARNIZIONE CARBURATORE	JOINT CARBURATEUR
7	BA1-910384	910384	TAPA TRASERA	END CAP - FRONT	GUARNIZIONE POSTERIORE	COUVERCLE ARRIÈRE
8	BAOMC1-907885	907885	TAPA DELANTERA	END CAP - REAR	GUARNIZIONE ANTERIORE	COUVERCLE AVANT
9	REC317624	552940	TORNILLO TAPA	SCREW - END CAP	VIS COPERCHIO	VITE COUVERCLE
10	REC13-39107	306470	CIERRE	LOCKWASHER	CHIUSURA	RONDELLE
11	REC16-70236	314616	PERNO CARBURADOR	STUD - CARBURETOR	PERNO CARBURATORE	VIS CARBURATORE
12	REC16-56826	3852093	PERNO COLECTOR ESCAPE	STUD - EXHAUST MANIFOLD	PERNO COLLETTORE	VIS COLLECTEUR
13	REC13-35048	120177	CIERRE	LOCKWASHER	CHIUSURA	RONDELLE
14	REC11-862903	552938	TUERCA	NUT	DADO	ÉCROU
15	BAOMC20-910380	3850799	CODO ESCAPE	EXHAUST ELBOW ASSEMBLY	GOMITO SCARICO	COUDE D'ÉCHAPPEMENT
16	REC3852142	306422	TUERCA	NUT	DADO	ÉCROU
17	REC909232	909232	MANGUITO ESCAPE	EXHAUST HOSE	MANICOTTO SCARICO	DURITE D'ÉCHAPPEMENT
18	REC909371	909371	MANGUITO ESCAPE	EXHAUST HOSE	MANICOTTO SCARICO	DURITE D'ÉCHAPPEMENT
19	GS38320	3852604	ABRAZADERA	CLAMP	FASCETA	COLLIER
20	REC3863450	3852741	MANGUITO ESCAPE	EXHAUST HOSE	MANICOTTO SCARICO	DURITE D'ÉCHAPPEMENT

4.3 / 4.3 H.O. GM 262 CID V6 (1986-90)

Este colector ya no se fabrica. Para sustituirlo utilizar todas las piezas del motor modelo: 4.3GM (1991+)
 This manifold is obsolete. Parts of the 4.3GM (1991+) must be used to replace it.
 Kit di trasformazione: qui sotto troverete i pezzi necessari per sostituire il collettore: 4.3 GM (1991+)
 Ce collecteur n'est plus fabriqué. Pour le remplacer, utilisez toutes les pièces du moteur modèle : 4.3GM (1991+)



4.3 GM 262 CID V6 (1991+)



REF	OEM
REC53773	

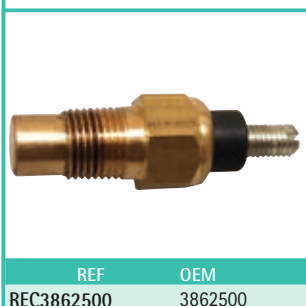

REF	OEM
REC3862500	3862500

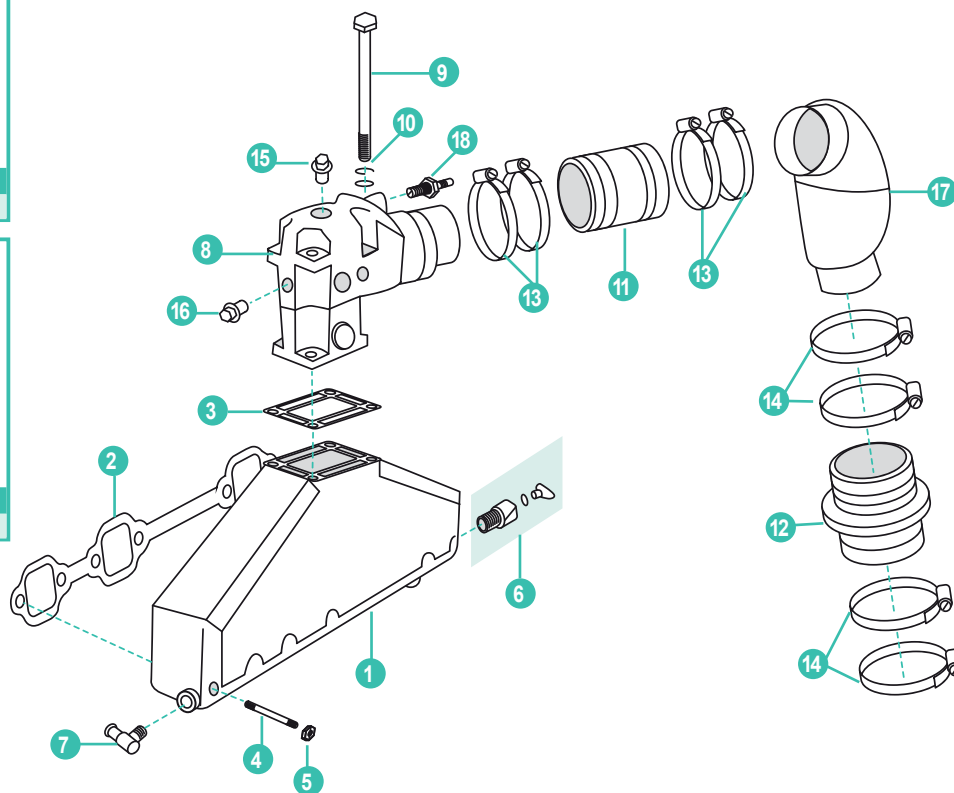

	REF	OEM				
1	MAR499	3847499	COLECTOR ESCAPE	EXHAUST MANIFOLD ASSEMBLY	COLLETTORE SCARICO	COLLECTEUR D'ÉCHAPPEMENT
2	REC27-99757	3853412	JUNTA COLECTOR ESCAPE	GASKET - EXHAUST MANIFOLD	COLLETTORE SCARICO	COLLECTEUR D'ÉCHAPPEMENT
3	REC3863191	351325	JUNTA CODO ESCAPE	GASKET - EXHAUST ELBOW	KIT GUARNIZIONE COLLETTORE SCARICO	KIT COUDE
4	REC3852467	3852467	PERNO	STUD	PERNO	VIS
5	REC46335	3853404	TUERCA	NUT	DADO	ÉCROU
6	REC479956		RACOR COLECTOR	STRAIGHT FITTING	RACCORDO	RACCORD
7	REC3852538	3852538	TORNILLO CODO	ELBOW FITTING	VITE GOMITO	VIS COUDE
8	MAR061	3857944	CODO ESCAPE	EXHAUST ELBOW ASSEMBLY	GOMITO SCARICO	VIS D'ÉCHAPPEMENT
9	REC3852830	3852830	TORNILLO	SCREW	VITE	VIS
10	REC13-35048	120177	CIERRE	LOCKWASHER	CHIUSURA	RONDELLE
11	REC3852696	3852696	MANGUITO ESCAPE	EXHAUST HOSE	MANICOTTO SCARICO	DURITE D'ÉCHAPPEMENT
12	REC3863450	3852741	MANGUITO ESCAPE	EXHAUST HOSE	MANICOTTO SCARICO	DURITE D'ÉCHAPPEMENT
13	GS38322	3853860	ABRAZADERA	CLAMP	FASCETTA	COLLIER
14	GS38320	3852604	ABRAZADERA	CLAMP	FASCETTA	COLLIER
15	REC22-73379		TAPÓN	PLUG	TAPPO	BOUCHON
16	REC22-428611	315713	TAPÓN	PLUG	TAPPO	BOUCHON
17	RM3854874	3854874	CURVA (1991-98) COLA SX	ELBOW SYSTEM DRIVE SX (1991-98)	CURVA (1991-98) PIEDE SX	COUDE SX (1991-98)
18	REC3862500	3862500	SENSOR TEMPERATURA	TEMPERATURE SENSOR	SENSORE TEMPERATURA	CAPTEUR TEMPÉRATURE

800 GM 305/350 CID V8
 BLOQUE PEQUEÑO | SMALL BLOCK | BLOCCO PICCOLO | BLOQUE PETIT (1979-89)



REF OEM
 REC18-8553



REF OEM
 HOT20244-MK

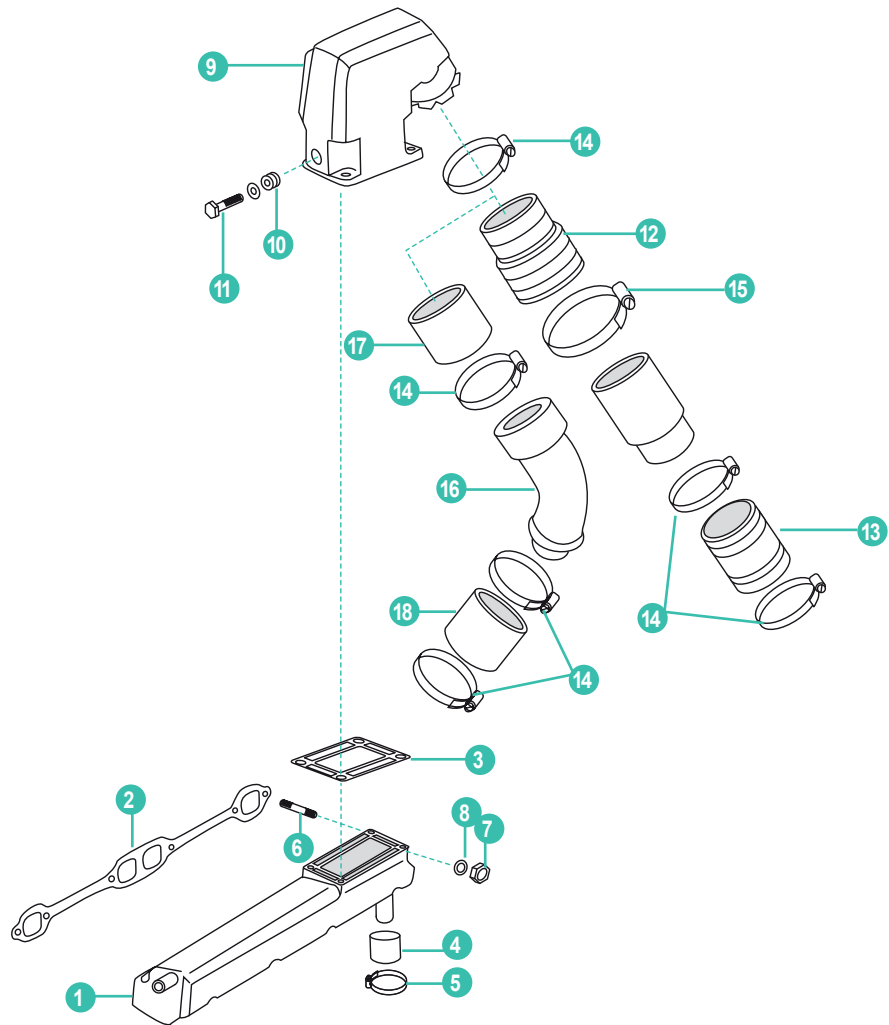

	REF	OEM				
1	HOT20903	912442	COLECTOR ESCAPE BABOR	EXHAUST MANIFOLD ASSEMBLY - PORT	COLLETTORE SCARICO BABORDO	COLLECTEUR D'ÉCHAPPEMENT BABORD
2	REC27-33395	3852468	JUNTA COLECTOR ESCAPE	GASKET - EXHAUST MANIFOLD	GUARNIZIONE COLLETTORE SCARICO	JOINT COLLECTEUR D'ÉCHAPPEMENT
3	REC3863191	3863191	JUNTA CODO ESCAPE	GASKET - EXHAUST ELBOW	GUARNIZIONE GOMITO SCARCIO	JOINT COUDE D'ÉCHAPPEMENT
4	REC764799	764799	TAPA	CAP	COPERCHIO	COUVERCLE
5	REC54-815504320	3853786	ABRAZADERA	CLAMP	FASCETTA	COLLIER
6	REC3852467	3852467	PERNO	STUD	PERNO	VIS
7	REC46335	908700	TUERCA	NUT	DADO	ÉCROU
8	REC13-35048	309336	CIERRE	LOCKWASHER	CHIUSURA	RONDELLE
9	HOT20921	909863	CODO ESCAPE	EXHAUST ELBOW ASSEMBLY	GOMITO SCARICO	COUDE D'ÉCHAPPEMENT
10	REC22-428611	315713	TAPÓN	PLUG	TAPPO	BOUCHON
11	REC13-39107	306325	CIERRE	LOCKWASHER	CHIUSURA	RONDELLE
12	REC912374	912374	MANGUITO ESCAPE (COBRA)	EXHAUST HOSE (COBRA)	MANCIOTTO SCARICO (COBRA)	DURITE D'ÉCHAPPEMENT (COBRA)
13	REC3852742	3852742	MANGUITO ESCAPE (COBRA)	EXHAUST HOSE (COBRA)	MANCIOTTO SCARICO (COBRA)	DURITE D'ÉCHAPPEMENT (COBRA)
14	GS38320	3852604	ABRAZADERA	CLAMP	FASCETTA	COLLIER
15	GS38322	984387	ABRAZADERA	CLAMP	FASCETTA	COLLIER
16	REC909610	909610	TUBO CODO BABOR	ELBOW TUBE - PORT (STRINGER MOUNT)	TUBO GOMITO BABORDO	DURITE COUDE BABORD
17	REC909232	909232	MANGUITO ESCAPE	EXHAUST HOSE	MANICOTTO SCARICO	DURITE D'ÉCHAPPEMENT
18	REC909371	909371	MANGUITO ESCAPE	EXHAUST HOSE	MANICOTTO SCARICO	DURITE D'ÉCHAPPEMENT

5.7L GM 350 CID V8
(1990+)

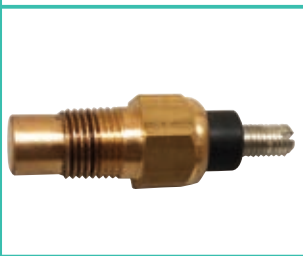

REF	OEM
REC3862500	3862500



REF	OEM
HOT20244-MK	

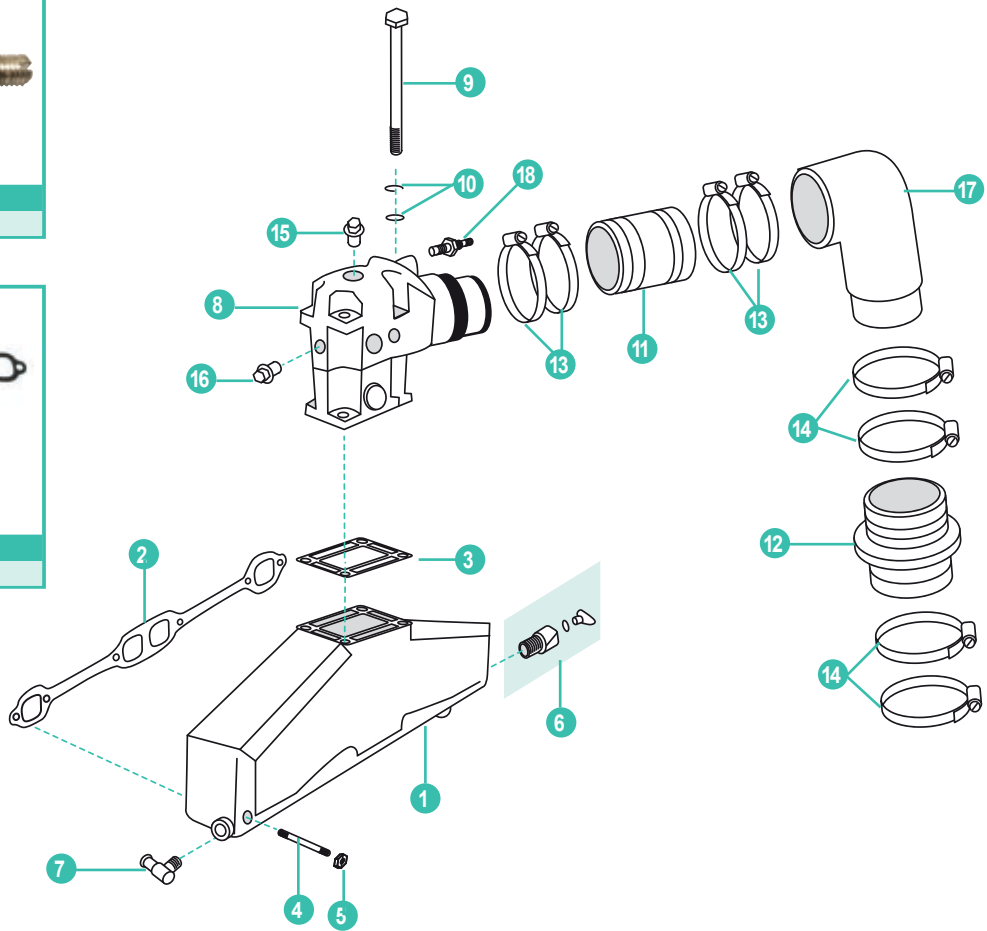

	REF	OEM				
1	MAR501	3857723	COLECTOR ESCAPE	EXHAUST MANIFOLD ASSEMBLY	COLLETORE SCARICO	COLLECTEUR D'ÉCHAPPEMENT
2	REC27-33395	3852468	JUNTA COLECTOR ESCAPE	GASKET - EXHAUST MANIFOLD	GUARNIZIONE COLLETORE SCARICO	JOINT COLLECTEUR D'ÉCHAPPEMENT
3	REC3863191	3863191	JUNTA CODO ESCAPE	GASKET - EXHAUST ELBOW	GUARNIZIONE GOMITO SCARICO	JOINT COUDE D'ÉCHAPPEMENT
4	REC3852467	3852467	PERNO	STUD	PERNO	VIS
5	REC46335	3853404	CIERRE	LOCKNUT	CHIUSURA	RONDELLE
6	REC479956		RACOR COLECTOR	STRAIGHT FITTING KIT	RACCORDO COLLETORE	RACCORD COLLECTEUR
7	REC3852538	3852538	RACOR CODO	ELBOW FITTING	RACCORDO GOMITO	RACCORD COUDE
8	MAR061	3857944	CODO ESCAPE	EXHAUST ELBOW	GOMITO SCARICO	COUDE D'ÉCHAPPEMENT
9	REC3852830	3852830	TORNILLO	SCREW	VITE	VIS
10	REC13-35048	120177 306405	CIERRE	LOCKWASHER	CHIUSURA	RONDELLE
11	REC3852696	3852696	MANGUITO ESCAPE	EXHAUST HOSE	MANICOTTO SCARICO	DURITE D'ÉCHAPPEMENT
12	REC3863450	3852741	MANGUITO ESCAPE	EXHAUST HOSE	MANICOTTO SCARICO	DURITE D'ÉCHAPPEMENT
13	GS38322	3853860	ABRAZADERA	CLAMP	FASCETTA	COLLIER
14	GS38320	3852604	ABRAZADERA	CLAMP	FASCETTA	COLLIER
15	REC22-73379		TAPÓN	PLUG	TAPPO	BOUCHON
16	REC22-428611	315713	TAPÓN	PLUG	TAPPO	BOUCHON
17	REC763891	763891	TUBO ESCAPE	EXHAUST TUBE	TUBO SCARICO	DURITE D'ÉCHAPPEMENT
18	REC3862500	3862500	SENSOR TEMPERATURA	TEMPERATURE SENSOR	SENSORE TEMPERTURA	CAPTEUR TEMPÉRATURE

5.0/5.8L & EFI FORD 302/351 CID V8
(1991+)

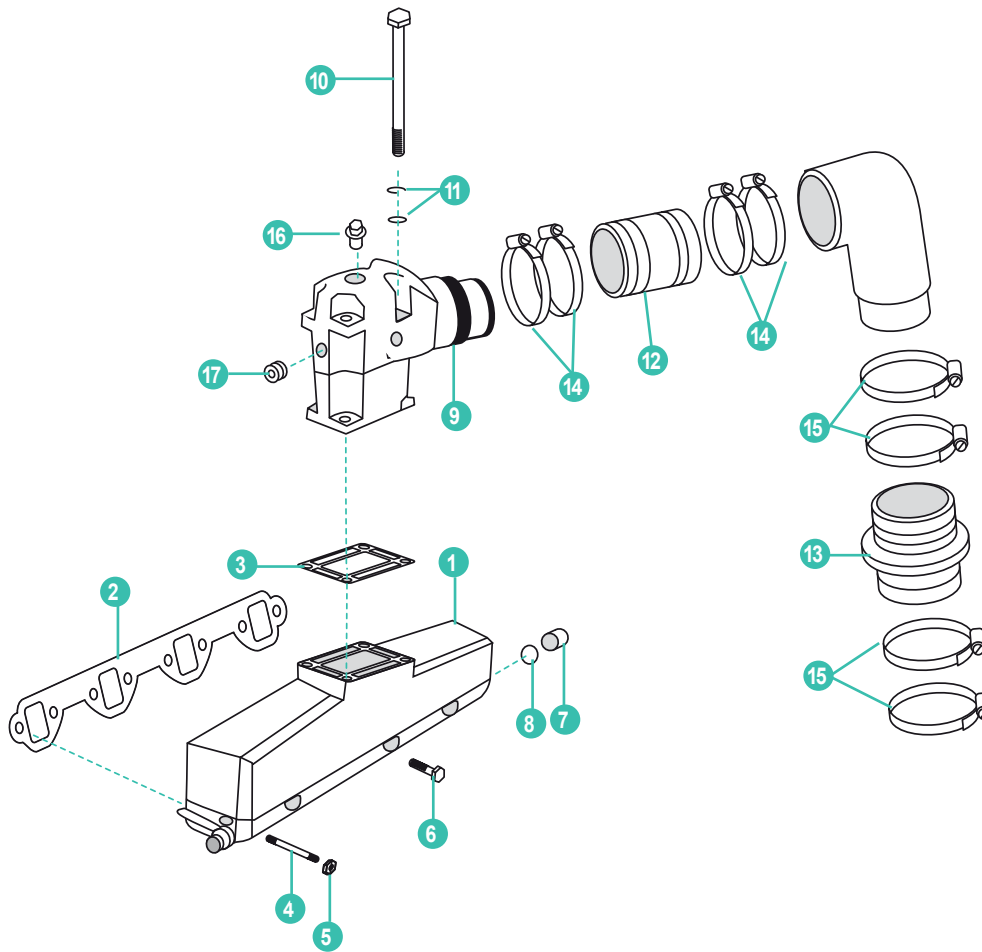

	REF	OEM				
1	BAOMC1-3852347	3852347	COLECTOR ESCAPE	EXHAUST MANIFOLD ASSEMBLY	COLLETTORE SCARICO	COLLECTEUR D'ÉCHAPPEMENT
2	REC3852455	3852455	JUNTA COLECTOR ESCAPE	GASKET - EXHAUST MANIFOLD	GUARNIZIONE COLLETTORE SCARICO	JOINT COLLECTEUR D'ÉCHAPPEMENT
3	REC3863191	3863191	JUNTA CODO ESCAPE	GASKET - EXHAUST ELBOW	GUARNIZIONE GOMITO SCARICO	JOINT COUDE D'ÉCHAPPEMENT
4	REC3853434	3853434	PERNO	STUD	PERNO	VIS
5	REC46335	3853404	TUERCA	NUT	DADO	ÉCROU
6	REC10-37612	3853155	TORNILLO	SCREW	VITE	VIS
7	REC3852476	3852476	TAPA	CAP	COPERCHIO	COUVERCLE
8	REC3852602	912627	ARANDELA	CLAMP	FASCETTA	COLLIER
9	MAR061	3857944	CODO ESCAPE (1988-96) CARB.	EXHAUST ELBOW ASSEMBLY (1988-96 CARB.)	GOMITO SCARICO CARBURATORE (1988-96)	COUDE D'ÉCHAPPEMENT (1988-96) CARB.
9	REC3855271	3855271	CODO ESCAPE BABOR (1993-96) EFI	EXHAUST ELBOW ASSLY - PORT (1993-96 EFI)	GOMITO SCARICO EFI BABORDO (1993-96)	COUDE D'ÉCHAPPEMENT (1993-96) BABORD - EFI
9	REC3855269	3855269	CODO ESCAPE ESTRIBOR (1993-96) EFI	EXHAUST ELBOW ASBLY - STBD (1993-96 EFI)	GOMITO SCARICO EFI TRIBORDO (1993-96)	COUDE D'ÉCHAPPEMENT (1993-96) TRIBORD - EFI
10	REC3852830	3852830	TORNILLO	SCREW	VITE	VIS
11	REC13-35048	120177 306405	CIERRE	LOCKWASHER	CHIUSURA	RONDELLE
12	REC3852696	3852696	MANGUITO ESCAPE	EXHAUST HOSE	MANICOTTO SCARICO	DURITE D'ÉCHAPPEMENT
13	REC3863450	3852741	MANGUITO ESCAPE	EXHAUST HOSE	MANICOTTO SCARICO	DURITE D'ÉCHAPPEMENT
14	GS38322	3853860	ABRAZADERA	CLAMP	FASCETTA	COLLIER
15	GS38320	3852604	ABRAZADERA	CLAMP	FASCETTA	COLLIER
16	REC22-73379		TAPÓN	PLUG	TAPPO	BOUCHON
17	REC22-428611	315713	TAPÓN	PLUG	TAPPO	BOUCHON

7.4/8.2L GM 454/502 CID V8
(1991+)

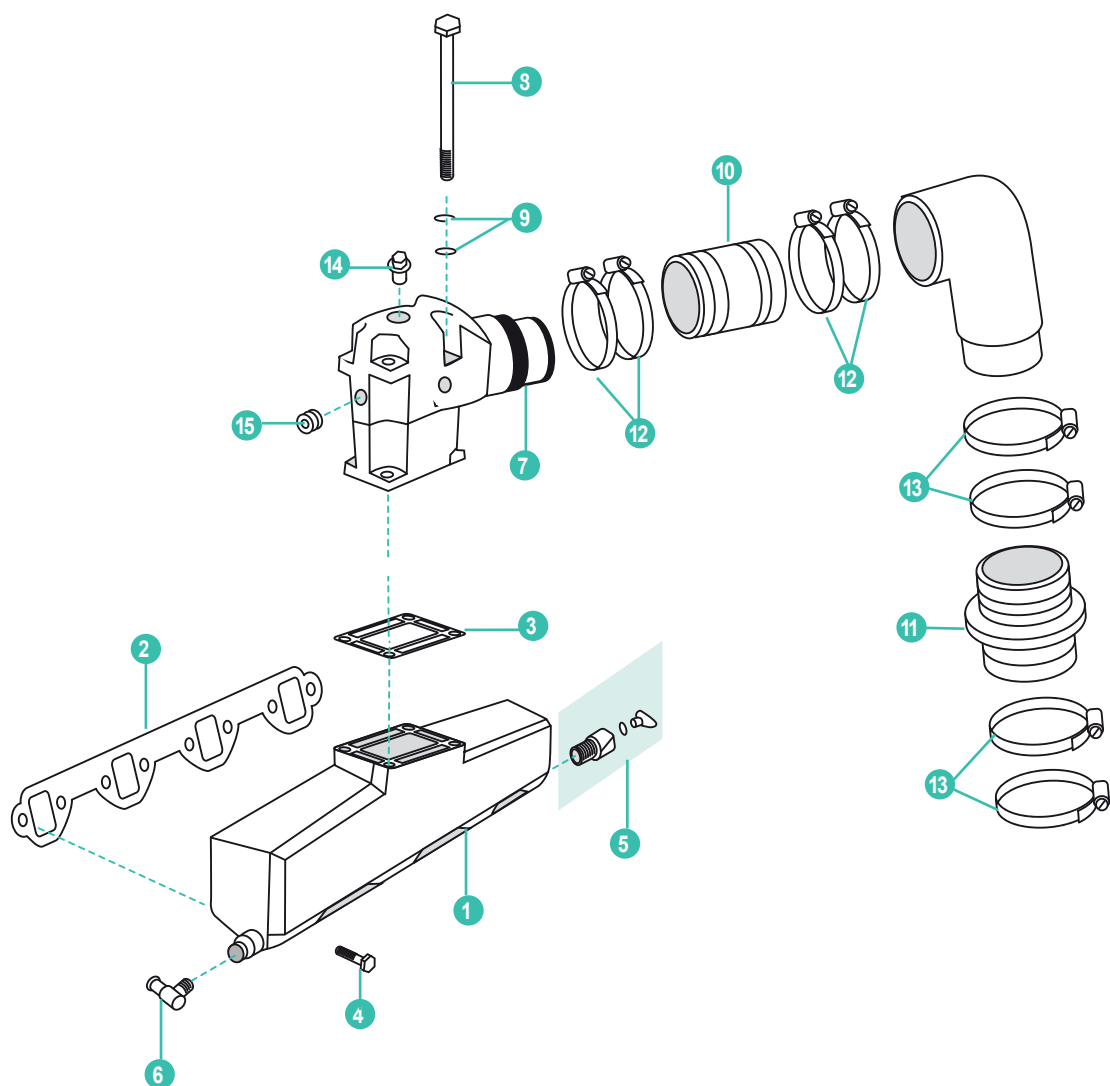

	REF	OEM				
1	RM3861459	3861459	COLECTOR ESCAPE	EXHAUST MANIFOLD ASSEMBLY	COLLETORE SCARICO	COLLECTEUR D'ÉCHAPPEMENT
2	REC27-46820	3852472	JUNTA COLECTOR ESCAPE	GASKET - EXHAUST MANIFOLD	GUARNIZIONE COLLETORE SCARICO	JOINT COLLECTEUR D'ÉCHAPPEMENT
3	REC3863191	3863191	JUNTA CODO ESCAPE	GASKET - EXHAUST ELBOW	GUARNIZIONE GOMITO SCARICO	JOINT COUDE D'ÉCHAPPEMENT
4	REC10-37612	3853326	TORNILLO	SCREW 3/8 - 16 X 1 1/4 FLANGE	PERNO	VIS
5	REC479956		RACOR COLECTOR	STRAIGHT FITTING	RACORDO COLLETORE	RACCORD COLLECTEUR
6	REC3852538	3852538	RACOR CODO	ELBOW FITTING	RACORDO GOMITO	RACCORD COUDE
7	MAR061	3857944	CODO ESCAPE	EXHAUST ELBOW ASSEMBLY	GOMITO SCARICO	COUDE D'ÉCHAPPEMENT
8	REC3852830	3852830	TORNILLO	SCREW	VITE	VIS
9	REC13-35048	120177 306405	CIERRE	LOCKWASHER	CHIUSURA	RONDELLE
10	REC3852696	3852696	MANGUITO ESCAPE	EXHAUST HOSE	MANICOTTO SCARICO	DURITE D'ÉCHAPPEMENT
11	REC3863450	3852741	MANGUITO ESCAPE	EXHAUST HOSE	MANICOTTO SCARICO	DURITE D'ÉCHAPPEMENT
12	GS38322	3853860	ABRAZADERA	CLAMP	FASCETTA	COLLIER
13	GS38320	3852604	ABRAZADERA	CLAMP	FASCETTA	COLLIER
14	REC22-73379		TAPÓN	PLUG	TAPPO	BOUCHON
15	REC22-428611	315713	TAPÓN	PLUG	TAPPO	BOUCHON

COLECTOR DE ESCAPE

EXHAUST MANIFOLD

COLLETTORE SCARICO

COLLECTEUR D'ÉCHAPPEMENT

REF	OEM	2.3 FORD 4 en línea 4 inline 4 en rete en ligne
HGE6041	986041	



REF	OEM	170, 175, 190, 235 HP V8 CID302 Et 351 FORD
BAOMC-1-980959	980959	



CODOS DE ESCAPE

EXHAUST ELBOWS

GOMITI SCARICO

COUDES D'ÉCHAPPEMENT

REF	OEM	2.3 FORD 4 en línea 4 inline 4 en rete en ligne
HGE3394	914766	



REF	OEM	155HP, V6 GM
BAOMC20-981281	981281	



REF	OEM	240HP, 302 Et 351 CID FORD
HOT20921	909863	



REF	OEM	170, 175, 190, 235 HP V8 CID302 Et 351 FORD
BAOMC20-980617	980617	



JUNTAS COLECTOR DE ESCAPE

EXHAUST MANIFOLD GASKET

GUARNIZIONE COLLETTORE DI SCARICO

JOINTS COLLECTEUR D'ÉCHAPPEMENT





REF	OEM	2.3 FORD 4 en línea 4 inline 4 en rete en ligne
REC913393	913393	



REF	OEM	KIT x 2 240HP 302 Et 351 CID FORD 170, 175, 190, 235 HP V8
FEL17460	913393	
REC3852455	3852455	



JUNTAS CODOS		ELBOW GASKET	GUARNIZIONE GOMITO	JOINTS COUDES	
REF	OEM		REF	OEM	
REC878982	912477	2.3 FORD 4 en línea 4 inline 4 en rete en ligne	REC3863191	913784	240HP, 302 & 351 CID FORD
					

JUNTAS TAPA		COVER GASKET	GUARNIZIONE COPERCHIO	JOINT COUVERCLE	
REF	OEM		REF	OEM	
BAOMC47-908935	908935	170, 175, 190, 235 HP V8 CID302 & 351 FORD	BAOMC47-311130	311130	155HP V6 GM
					

TAPÓN DE GOMA		RUBBER CAP	TAPPO IN GOMMA	BOUCHON EN CAOUTCHOUC
REF	OEM			
REC764799	764799	240HP, 302 & 351 CID FORD		
REC3852476	909829 3852476			

TAPA		COVER	COPERCHIO	COUVERCLE	
REF	OEM		REF	OEM	
BA1-908719	908716	170, 175, 190, 235 HP V8 CID302 & 351 FORD	BA1-312148	312148	155HP V6 GM
					

BOMBA DE CIRCULACIÓN BLOQUE

BLOCK CIRCULATING PUMP

POMPA DI RICIRCOLO DI BLOCCO

POMPE DE BRASSAGE

BOMBAS

PUMPS

POMPE

POMPES

REF	OEM	
REC46-8M0113733	3858340	GM 4L





REF	OEM	
REC46-8M0113735	3855991	GM V8 (bloque grande big block blocco grande bloque grande)



REF	OEM	
REC46-8M0113734	3853850 985429	GM V6 & V8 (bloque pequeño small block blocco piccolo bloque petit)



REF	OEM	
REC3853796	982517 3471293	Ford 5.0L & 5.8L



MANGUITO

HOSE

MANICOTTO

DURITE

REF	OEM	
REC32-33189	312781	COBRA



REF	OEM	
REC32-8M0071007	0509282	



UNIDADES DE TRANSMISIÓN TRANSMISSION UNIT

UNITÀ DI TRASMISSIONE EMBASES ET PIÈCES

RECMAR®

ÁNODO

ANODE

ANODI

ANODE

REF	OEM	KG (kg)	
ZN REC987067	3854061	0,98	
AL REC987067AL			



COBRA 5700



REF	OEM	KG (kg)	
ZN REC986158	3853930	0,61	
AL REC986158AL			



TRANSOM COBRA (1986-93)





REF	OEM	KG (kg)	
ZN REC3851411	3855411	1,04	
AL REC3863193AL		0,41	

COBRA (1994-98)





REF	OEM	KG (kg)	
ZN REC397768	397768	0,31	
AL REC397768AL		0,12	



REF	OEM	KG (kg)	
ZN REC983494	983494	0,82	
AL REC983494AL		0,32	

400-800 (1978-85)





REF	OEM	KG (kg)	
ZN REC983952	984547	0,91	
AL REC983952AL	983952	0,35	

COBRA





REF	OEM	KG (kg)	
ZN REC976669	976669	0,43	
AL REC976669AL		0,17	



REF	OEM	KG (kg)	
ZN REC982438	982438	0,83	
AL REC982438AL			



100-245 HP



REF	OEM	KG (kg)	
ZN REC436745	436745	0,22	
AL REC436745AL		0,09	

400-800 (1978-85)
COBRA (1986-93)



REF	OEM	KG (kg)	
ZN REC431708	431708	0,27	
AL REC431708AL		0,24	

400-800 (1978-85)
COBRA (1986-93)





OMC

RECAMBIOS
MARINOS



ÁNODO ANODE ANODI ANODE

REF	OEM	 (kg)	
ZN CM984513	3853818	0,97	COBRA (1986-93)
AL CM984513A		0,38	



KITS DE ÁNODOS ANODES KIT KIT ANODI KIT ANODES

KIT	ÁNODO ZN ZN ANODE ANODO ZN ANODE ZN	OEM	 (kg)	
CMCC			0,93	COBRA
	CMC		0,45	



UNIDADES DE TRANSMISIÓN UNIT DRIVES UNITÀ DI TRASMISSIONE EMBASES

KIT CONVERSIÓN OMC-COBRA CONVERSION KIT OMC-COBRA KIT CONVERSIONE OMC - COBRA KIT CONVERSION OMC - COBRA

Kit para adaptar las colas Mercruiser a las antiguas unidades OMC-Cobra hasta 300 HP, con el cambio en la unidad inferior. Fácil instalación.

This kit will work on Cobra drives up to 300 HP. Easy to replace the aging Cobra drives with a current style drive that has readily available spare parts.

Kit per adattare i piedi Mercruiser alle vecchie unità OMC-Cobra fino a 300 HP, con il cambio nella unità inferiore. Facile installazione.

Kit pour adapter les embases Mercruiser aux anciennes unités OMC-Cobra jusqu'à 300 CV, avec changement de l'unité inférieure. Installation facile.

REF
REC9D-116

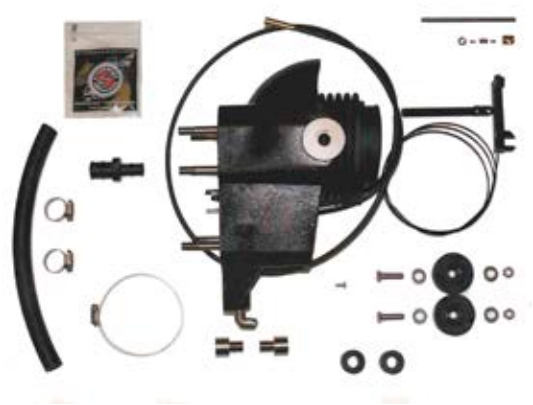

PARTE INFERIOR COMPLETA COMPLETE GEAR HOUSING ASSEMBLY PARTE INFERIORE COMPLETA PARTIE INFÉRIEURE COMPLETE

REF	OEM	REDUCCIÓN RATIO RIDUZIONE RÉDUCTION	
REC987800	987800	12:22	3.0, 4.3, 5.0, 5.7 & 5.8L 3.0, 4.3, 5.0, 5.7 & 5.8L

COBRA (1986-93)



OMC

RECAMBIOS MARINOS

COBRA (1986-93)

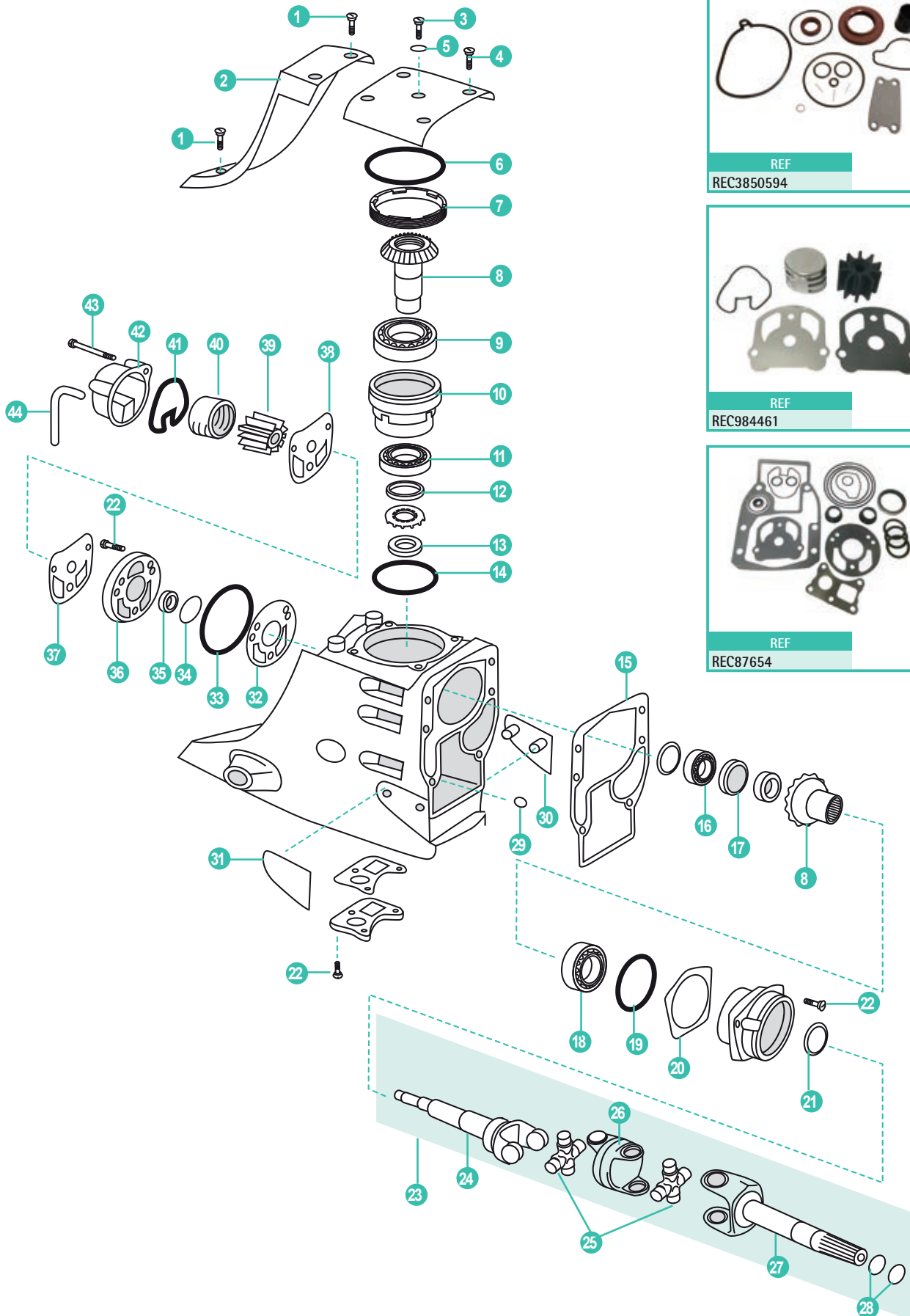

	REF	OEM				
1	REC3852568	3852568	TORNILLO	SCREW	VITE	VIS
2	REC983967	983967	TAPA	COVER ASSY.	COPERCHIO	COUVERCLE
3	REC914488	914488	TORNILLO NIVEL	DIPSTICK	ASTINA	VIS DE VIDANGE
4	REC123018	123018	TORNILLO	SCREW	VITE	VIS
5	REC3852045	303067	ARO TORICO	O-RING	ANELLO	JOINT TORIQUE
6	REC313175	313175	ARO TÓRICO	O-RING	ANELLO	JOINT TORIQUE
7	REC911751	911751	ARANDELA CIERRE	LOCK WASHER	RONDELLA CHIUSURA	RONDELLE FREIN
	REC983825	983825	KIT PIÑONES (21:16) V8	GEAR SET (21:16) V8	KIT PIGNONE (21:16) V8	KIT PIGNONS (21:16) V8
8	REC984012	984012	KIT PIÑONES (21:19) V6	GEAR SET (21:19) V6	KIT PIGNONE (21:19) V6	KIT PIGNONS (21:19) V6
	REC983826	983826	KIT PIÑONES (21:18) V8	GEAR SET (21:18) V8	KIT PIGNONE (21:18) V8	KIT PIGNONS (21:18) V8
9	REC31-35990A1	983891	COJINETE	BEARING	CUSCINETTO	ROULEMENT
10	REC911750	911750	CUERPO COJINETE	BEARING CARRIER	CORPO CUSCINETTO	PALIER DE ROULEMENT
11	REC983892	983892	COJINETE	BEARING	CUSCINETTO	ROULEMENT
12	REC911697	911697	ARANDELA	WASHER	RONDELLA	RONDELLE
13	REC911753	911753	TUERCA PIÑÓN	PINION NUT	DADO	ECROU DE PIGNON
14	REC911668	911668	GRUESO	SHIM 0.010	SPESSORE	CALE
15	REC915840	915840	KIT JUNTAS	GASKET SET	KIT GUARNIZIONE	KIT JOINTS
16	REC983878	983878	COJINETE	BEARING	CUSCINETTO	ROULEMENT
17	REC911937	911937	TUERCA PIÑÓN	U-JOINT NUT	DADO	ÉCROU DE PIGNON
18	REC983877	983877	COJINETE	BEARING	CUSCINETTO	ROULEMENT
19	REC25-70937	911686	ARO TÓRICO	O-RING	ANELLO	JOINT TORIQUE
	REC911678	911678	GRUESO	SHIM 0.003	SPESSORE	CALE
20	REC911679	911679	GRUESO	SHIM 0.004	SPESSORE	CALE
	REC911680	911680	GRUESO	SHIM 0.005	SPESSORE	CALE
	REC911681	911681	GRUESO	SHIM 0.010	SPESSORE	CALE
21	REC911685	911685	RETÉN	OIL SEAL	PARAOLIO	JOINT SPI
22	REC3852454	908668	TORNILLO	SCREW	VITE	VIS
23	REC983880	983880	CARDÁN COMPLETO	U-JOINT & WATER PUMP SHAFT	CARDANO COMPLETO	CARDAN AVEC ARBRE
24	REC984264	984264	EJE BOMBA AGUA	YOKE & WATER PUMP SHAFT	ASSE POMPA ACQUA	ARBRE POMPA D'EAU
25	REC3850812	3850812	CRUCETA CARDAN 1990-93	UNIVERSAL JOINT	CROCETTA CARDANO (1990-93)	CROISILLON (1990-93)
	REC75832T	912214	CRUCETA CARDAN 1986-99	UNIVERSAL JOINT	CROCETTA CARDANO (1986-99)	CROISILLON(1986-99)
26	REC393831	912213	CARDAN	SOCKET	CARDANO	CARDAN
27	REC59830A7	912212	UNIÓN COLA MOTOR	YOKE-DRIVE SHAFT	UNIONE MOTORE	CARDAN
28	REC25-25439	3852565	ARO TÓRICO	O-RING	ANELLO	JOINT TORIQUE
29	RM3852516	910953	ARO RETENEDOR	RETAINER RING	ANELLO FERMO	RONDELLE FREIN
30	REC3589522	3852561	TAPA LATERAL	THRUST PLATE	COPERCHIO LATERALE	COUVERCLE LATERALE
31	REC3589524	3852562	TAPA LATERAL	THRUST PLATE	COPERCHIO LATERALE	COUVERCLE LATERALE
32	REC911698	911698	JUNTA	GASKET	GUARNIZIONE	JOINT
33	REC911700	911700	ARO TÓRICO	O-RING	ANELLO	JOINT TORIQUE
34	REC909316	909316	ARO TÓRICO	O-RING	ANELLO	JOINT TORIQUE
35	REC3853655	3853655	RETÉN	OIL SEAL	PARAOLIO	JOINT SPI
36	REC911699	911699	BASE BOMBA AGUA	WATER PUMP ADAPTER	BASE POMPA ACQUA	BASE POMPE
37	REC802385	911702	JUNTA	GASKET	GUARNIZIONE	JOINT
38	REC911703	911703	TAPA BOMBA AGUA	WEAR PLATE	COPERCHIO POMPA ACQUA	COUVERCLE POMPA
39	REC777128 CEF500317	777128	TURBINA	IMPELLER	GIRANTE	TURBINE
40	REC764197	764197	CASQUILLO CUERPO BOMBA	WATER PUMP LINER	BOCCOLA CORPO POMPA	CAGE DE POMPE A EAU
41	REC911704	911704	RETÉN	OIL SEAL	PARAOLIO	JOINT SPI
42	REC984744	984744	TAPA BOMBA AGUA	PUMP HOUSING	COPERCHIO POMPA ACQUA	COUVERLCE POMPA
43	REC912238	912238	TORNILLO	SCREW	VITE	VIS
44	REC912614	912614	TUBO	VENT HOSE	TUBO	DURITE

COBRA (1986-93)

Las colas Cobra con motores 3.0L de (1986-89) utilizan una parte inferior de menos diámetro como los motores 2.3L de (1987-90). Las posteriores utilizan la misma parte inferior que los V6 y V8.

The (1986-89) Cobra Sterndrives with four-cylinder 3.0L engines utilize a small diameter lower gear housing. The (1990-93) four-cylinder 3.0L Cobra Sterndrives use the same large diameter lower gear housing as the 1986-1993 V6 and V8 powered Cobra Sterndrives. (1987-90) 2.3L engines use the small gear housing.

I piedi Cobra con motori 3.0L del (1986-89) utilizzano la parte bassa differente ed è più piccola come nei motori 2.3L dal (1987-90), utilizzano la stessa parte inferiore che i V6 e V8.

Les embases de Cobra équipées de moteurs 3.0L (1986-89) ont un alésage inférieur comme les moteurs 2.3L (1987-90). Les modèles ultérieurs utilisent le même bloc moteur que les V6 et V8.

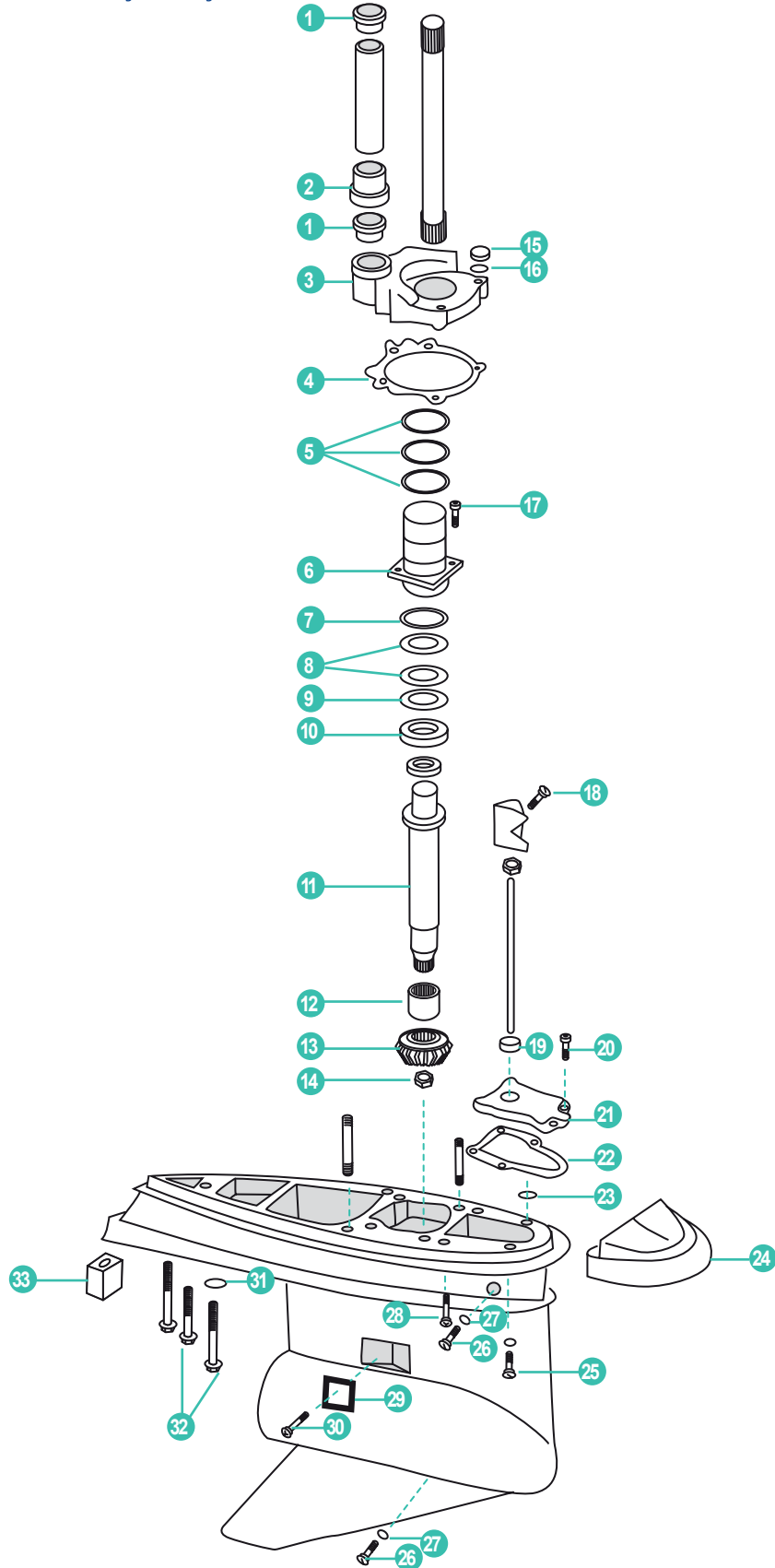

	REF	OEM				
1	REC911705	911705	RETÉN	SEAL	PARAOLIO	JOINT SPI
2	REC911715	911715	GUÍA TUBO	GUIDE	GUIDA TUBO	GUIDE
3	REC915720	915720	TAPA GUÍA TUBO	WASHER	COPERCHIO GUIDA TUBO	COUVERCLE GUIDE
4	REC915719	915719	JUNTA	GASKET	GUARNIZIONE	JOINT
5	REC318717	318717	ARO TÓRICO	O-RING	ANELLO	JOINT SPI
6	REC984462	984462	CUERPO COJINETE	BEARING HNG	CORPO CUSCINETTO	PALIER DE ROULEMENT
7	REC314728	314728	ARO TÓRICO	O-RING	ANELLO	JOINT SPI
	REC323362	323362	SUPLEMENTO .003	SHIM	SPESSORE	CALE .003
8	REC323361	323361	SUPLEMENTO .004	SHIM	SPESSORE	CALE .004
	REC314745	314745	SUPLEMENTO .005	SHIM	SPESSORE	CALE .005
9	REC327656	327656	ARANDELA TOPE	THRUST WASHER	RONDELLA	RONDELLE FREIN
10	REC387656	387656	TOPE COJINETE	THRUST BEARING	FERMO CUSCINETTO	ROULEMENT
11	REC764197	764197	CASQUILLO CUERPO BOMBA	WATER PUMP LINER	BOCCOLA CORPO POMPA	CAGE DE POMPE A EAU
	REC984744	984744	TAPA BOMBA AGUA	PUMP HOUSING	COPERCHIO POMPA ACQUA	COUVERLCE POMPA
12	REC912238	912238	TORNILLO	SCREW	VITE	VIS
	REC912614	912614	TUBO	VENT HOSE	TUBO	DURITE
13	REC986979	986979	KIT PIÑONES 4 L (1986-93)	GEAR SET 4L (1986-93)	KIT PIGNONE 4L (1986-93)	KIT PIGNONES 4L (1986-93)
14	REC11-35921	314730	TUERCA	NUT	DADO	ÉCROU
15	REC11-8267089	121731	TAPÓN	NUT	TAPPO	BOUCHON
16	PAGB/T848-6	305981	ARANDELA	WASHER	RONDELLA	RONDELLE
17	REC317624	317624	TORNILLO	SCREW	VITE	VIS
18	REC308825	308825	TORNILLO	SCREW	VITE	VIS
19	REC912157	912157	CASQUILLO	WIPER	BOCCOLA	BAGUE
20	REC304027	304027	TORNILLO	SCREW	VITE	VIS
21	REC986838	986838	TAPA CON RETÉN	COVER Et SEAL	TAPPO CON PARAOLIO	COUVERCLE AVEC JOINT
22	REC911878	911878	JUNTA	GASKET	GUARNIZIONE	JOINT
23	REC318372	318372	ARO TÓRICO	O-RING	ANELLO	JOINT TORIQUE
24	CM984513	3853818	ANODO	ANODE	ANODO	ANODE
25	REC912127	912127	TORNILLO	SCREW	VITE	VIS
26	REC22-67892A05	318544	TORNILLO	SCREW	VIRE	VIS
27	REC3855081	311598	ARO TÓRICO	O-RING	ANELLO	JOINT OTRIQUE
28	REC331999	331999	TORNILLO	SCREW	VITE	VIS
29	REC337778	337778	REJILLA	SCREEN	GRIGLIA	GRILLE
30	REC337061	337061	TORNILLO	SCREW	VITE	VIS
31	REC330265	330265	ARANDELA	O-RING	RONDELLA	RONDELLE
32	REC328096	328096	TORNILLO	SCREW	VITE	VIS
33	CM393023	436745	ANODO	ANODE	ANODO	ANODE

COBRA (1986-93)

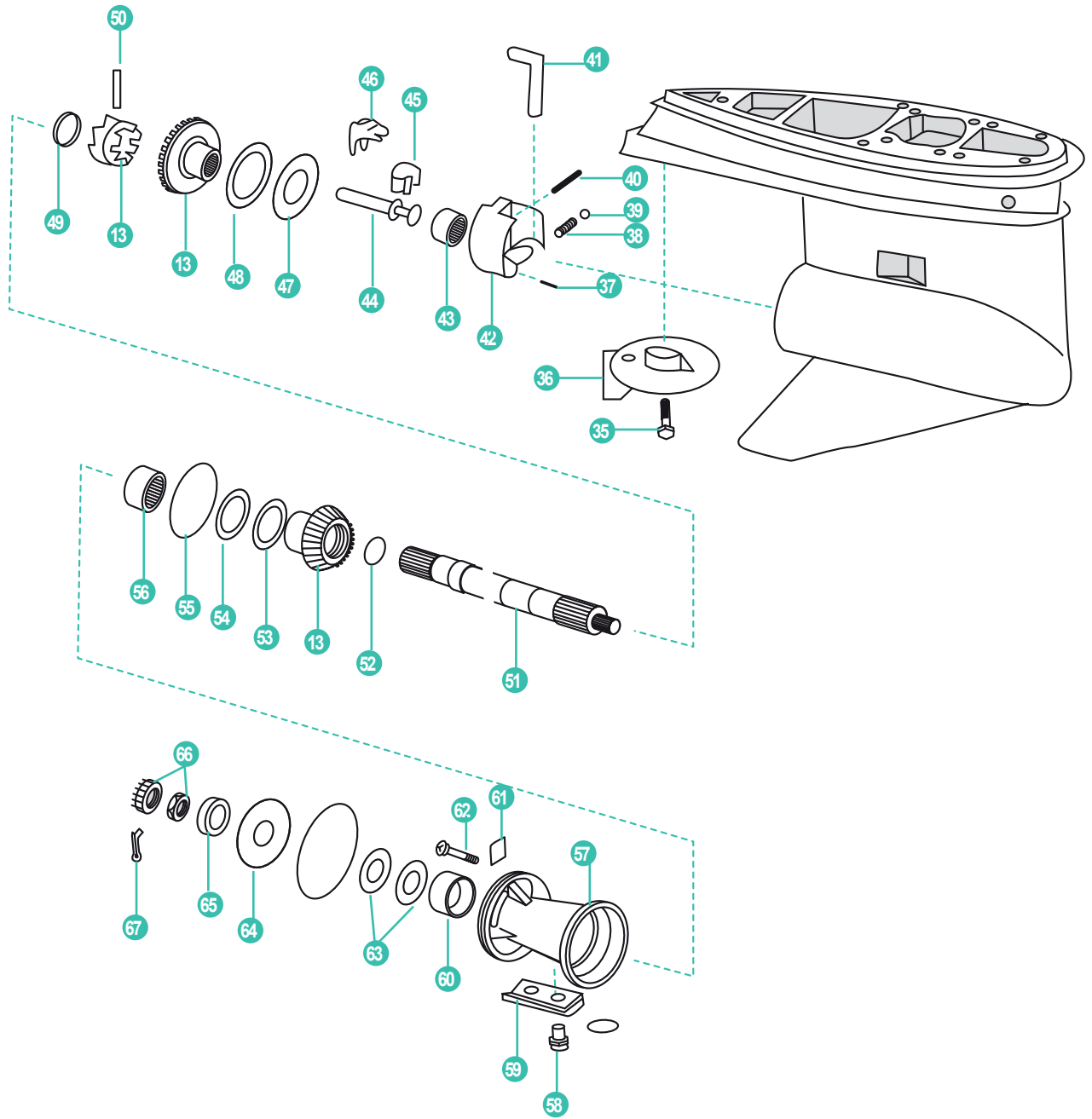

REF
 REC439967 439967 3.0L (1990-93),
 984458 V6 / V8 (1986-93)
 KING COBRA

REF
 REC985612 985612 4 Cyl (1986-89),
 2.3 L (1987-90)

	REF	OEM			
13	REC5004218	986980	KIT PIÑONES V6-V8 (1986-93)	GEAR SET V6-V8 (1986-93)	KIT PIGNONE V6-V8 (1986-93)
	REC986979	986979	KIT PIÑONES 4 L (1986-93)	GEAR SET 4L (1986-93)	KIT PIGNONE 4L (1986-93)
35	REC313715	313715	TORNILLO	SCREW	VITE
36	TEN00712	912392	ALETA	TRIM TAB	TRIM TAB
37	REC331880	331880	PASADOR	PIN	CHIAVISTELLO
38	REC911962	385367	MUELLE	SPRING	MOLLA
39	REC160084	160084	BOLA	DETENT BALL	BOLLA
40	REC328825	328825	PASADOR	PIN	SPINOTTO
41	REC915954	915954	EJE VARILLA CAMBIO	DETENT	ASTICELLA CAMBIO
42	REC389455	389455	TAPA COJINETE	HOUSING & BEARING ASSY.	COPERCHIO CUSCINETTO
43	REC389039	389039	COJINETE	BEARING	CUSCINETTO
	REC382407	382407	COJINETE GM 4L	BEARING	CUSCINETTO GM 4L
44	REC322941	322941	EJE DESPLAZABLE	SHAFT	ASSE SELETTORE
45	REC334163	334163	REGULADOR EJE	CRADLE	REGOLATORE ASSE
46	REC322938	322938	UÑA DESPLAZABLE	LEVER	LEVA
47	REC327669	327669	TOPE ARANDELA	THRUST WASHER	RONDELLA
	REC324766	324766	TOPE ARANDELA GM 4L	THRUST WASHER	RONDELLA GM 4L
48	REC389042	389042	TOPE COJINETE	THRUST BRING	RONDELLA
	REC385043	385043	TOPE COJINETE GM 4L	GM 4L T B	RONDELLA GM 4L
49	REC324369	324369	MUELLE	SPRING	MOLLA
50	REC313448	313448	PASADOR DESPLAZABLE	CROSS PIN	CHIAVISTELLO
	REC395209	395209	EJE (1986-90) Ø1-3/16	PROP SHAFT 1-3/16 Ø (1986-90)	ASSE (1986-90) Ø1-3/16
51	REC5004765	5004765	EJE (1991-93) Ø1-1/4	PROP SHAFT 1-1/4 Ø (1991-93)	ASSE (1991-93) Ø1-1/4
	REC436888	436888	EJE HÉLICE GM 4L	PROP SHAFT GM 4L	ASSE ELICA GM 4L
52	REC336565	336565	ARANDELA	THRUST WASHER	RONDELLA
53	REC382408	382408	TOPE COJINETE	THRUST BEARING	RONDELLA CUSCINETO
54	REC314731	314731	TOPE ARANDELA	THRUST WASHER	RONDELLA
55	REC967344	313446	ARO TÓRICO	O-RING	ANELLO
56	REC382407	382407	COJINETE	BEARING	CUSCINETTO
57	REC5000074	5000074	COJINETE DIÁBOLO 1986-90)	BEARING CARRIER	CUSCINETTO DIAVOLO (1986-90)
	REC5004257	5004257	COJINETE DIÁBOLO (1991-93)	BEARING CARRIER	CUSCINETTO DIAVOLO (1991-93)
58	REC908158	908158	TORNILLO	SCREW	VITE
59	CM431708	431708	ANODO	ANODE	ANODO
	REC387247	387247	COJINETE (1986-90)	BEARING (1986-90)	CUSCINETTO (1986-90)
60	REC434467	434467	COJINETE (1991-93)	BEARING (1991-93)	CUSCINETTO (1991-93)
	REC379504	379504	COJINETE GM 4L	BEARING	CUSCINETTO GM 4L
61	REC333957	333957	PESTAÑA SUJECCIÓN	TAB	PIASTRA SUPORTO
62	REC350271	350271	TORNILLO	SCREW	BULLONE
63	REC334950	334950	RETÉN (1986-90)	OIL SEAL (1986-90)	PARAOLIO (1986-90)
	REC330137	330137	RETÉN (1991-93)	OIL SEAL (1991-93)	PARAOLIO (1991-93)
64	REC126870	126870	TOPE ARANDELA	THRUST WASHER	RONDELLA
65	REC320570	320570	TOPE HÉLICE	SPACER	SPESSORE
66	REC398042	5008966	KIT TUERCA HÉLICE	NUT & KEEPER	KIT DADO ELICA
67	REC3852056	306394	PASADOR	COTTER PIN	CHIAVISTELLO

COBRA (1994-98)

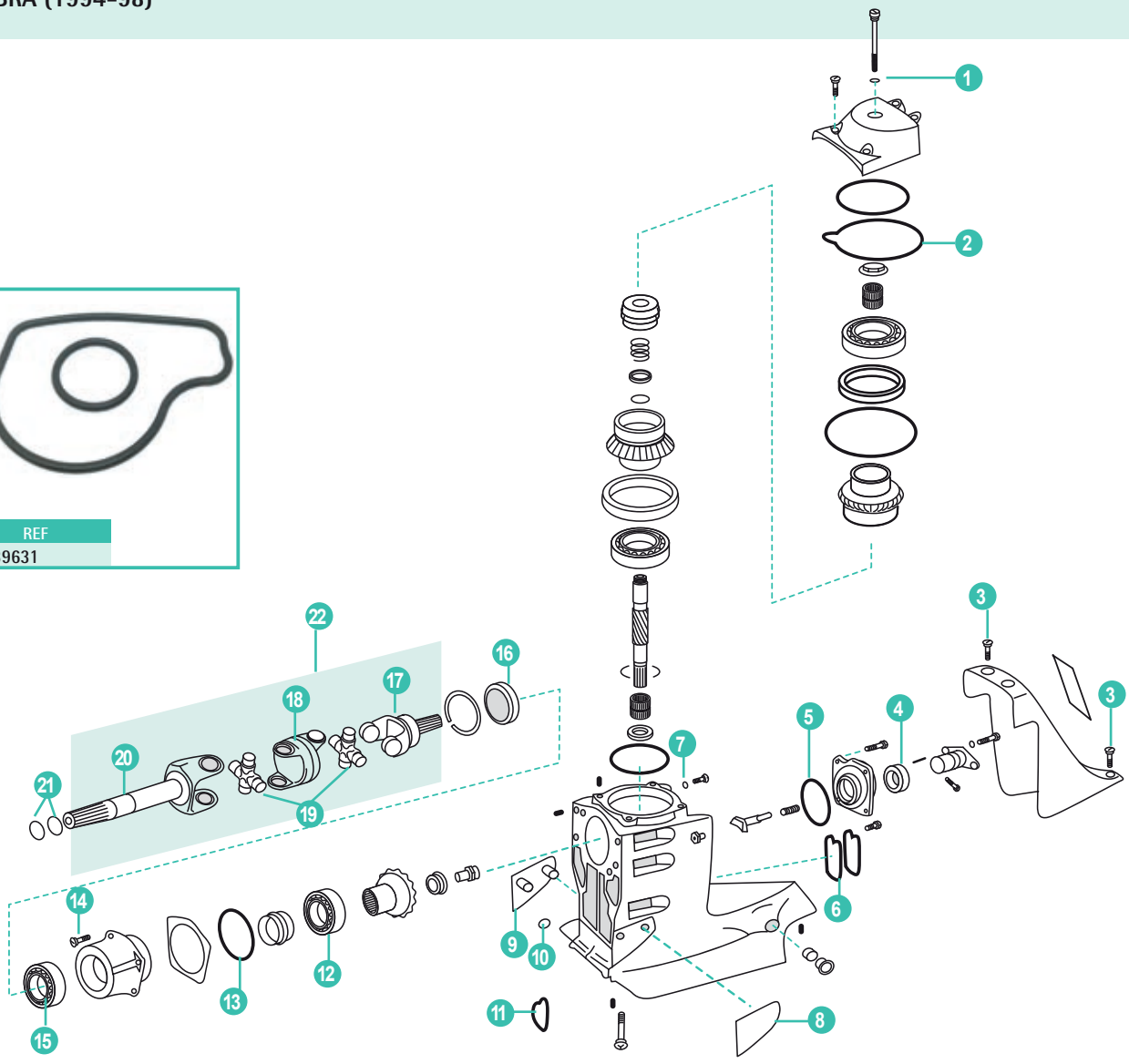

	REF	OEM				
1	REC3852045	303067	ARANDELA	O-RING	RONDELLA	RONDELLE
2	REC3852317	3852317	JUNTA	GASKET	GUARNIZIONE	JOINT
3	REC3852568	3852568	TORNILLO	SCREW	VITE	VIS
4	REC853868	853858	RETEN ACEITE	OIL SEAL	PARAOLIO	POINT SPI
5	REC925093	925093	ARANDELA	O-RING	RONDELLA	RONDELLE
6	REC3852279	3852279	JUNTA	GASKET	GUARNIZIONE	JOINT
7	REC3855081	333572	JUNTA	GASKET	GUARNIZIONE	JOINT
8	REC3589522	3852561	TAPA	THRUST PLATE	COPERCHIO	COUVERCLE
9	REC3589524	3852562	TAPA	THRUST PLATE	COPERCHIO	COUVERCLE
10	REC3852165	910953	ARO RETENEDOR	RETAINING RING	TENUTA	JOINT TORIQUE
11	REC3852560	3852560	RETEN	SEAL	TENUTA	JOINT TORIQUE
12	REC3850852	3850852	COJINETE	BEARING	CUSCINETTO	ROULEMENT
13	REC967344	3852308	ARANDELA	O-RING	RONDELLA	RONDELLE
14	REC3852454	908668	TORNILLO	SCREW	VITE	VIS
15	REC183247	3850853	COJINETE	BEARING	CUSCINETTO	ROULEMENT
16	REC3852272	3852272	RETEN ACEITE	OIL SEAL	PARAOLIO	JOINT SPI
17	REC3850814	3850814	EJE CORTO CARDAN	YOKE	ASSE CORTO CARDANO	ARBRE
18	REC393831	912213	CARDAN	SOCKET	CARDANO	CARDAN
19	REC3850812	3850812	CRUCETA CARDAN	U-JOINT	CROCETTA CARDANO	CROISILLON
20	REC59830A7	912212	UNION COLA MOTOR	YOKE-LONG	UNION COLA MOTORE	CARDAN
21	REC25-25439	3852565	ARANDELA	O-RING	RONDELLA	RONDELLE
22	REC3860842	3860842	TRANSMISIÓN	U-JOINT ASSY	TRAMMISSIONE	CARDAN AVEC ARBRE

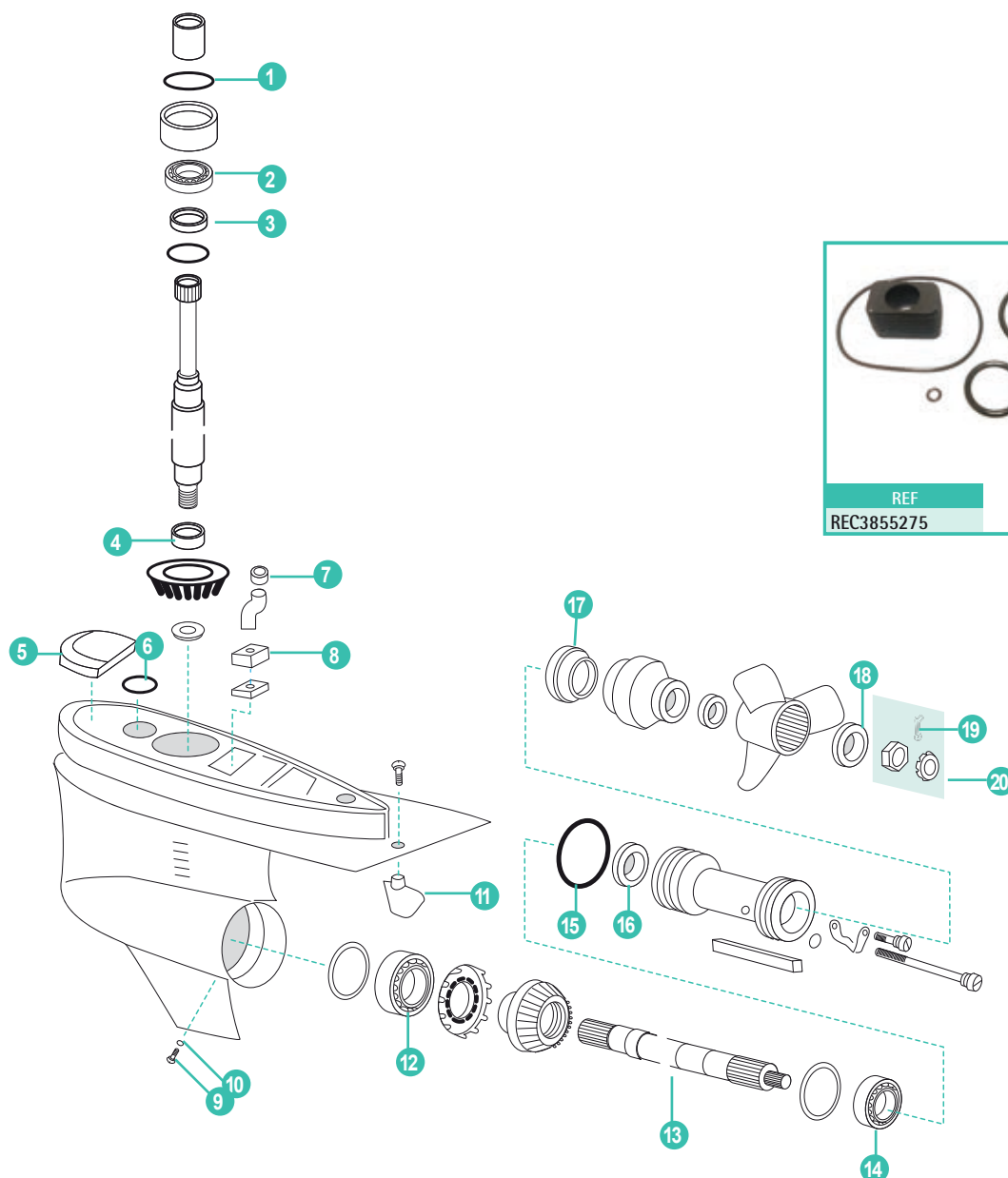

	REF	OEM				
1	REC3852866	3852866	ARO	O-RING	ANELLO	JOINT SPI
2	REC31-86748A1	3854250	COJINETE	BEARING	CUSCINETTO	ROULEMENT
3	REC31-66668A1	3854249	COJINETE	BEARING	CUSCINETTO	ROULEMENT
4	REC3853934	3853934	COJINETE	BEARING	CUSCINETTO	ROULEMENT
5	CM3855411	3855411	ANODO	ANODE	ANODO	ANODE
6	REC3852959	3852959	ARO	O-RING	ANELLO	JOINT TORIQUE
7	REC3852315	3852315	SUPLEMENTO	GROMMET	SPESSORE	CALE
8	REC3854595	3854595	RETÉN	SEAL	TENUTA	JOINT SPI
9	REC22-67892A05	3854539	TORNILLO	SCREW	VITE	VIS
10	REC3855081	333572	ARANDELA	WASHER	RONDELLA	RONDELLE
11	REC854040	3854402	TIMON COLA	TRIM TAB	TIMONE PIEDE	ANODE
12	REC3850942	3850942	COJINETE	BEARING	CUSCINETTO	ROULEMENT
13	REC3857675	3857675	EJE HÉLICE	PROP SHAFT	ASSE ELICA	ARBRE HÉLICE
14	REC31-66668A1	3854249	COJINETE	BEARING	CUSCINETTO	ROULEMENT
15	REC3852865	3852865	ARO	O-RING	ANELLO	JOINT TORIQUE
16	REC3863090	3863090	RETÉN ACEITE	OIL SEAL	PARAOILIO	JOINT SPI
17	REC126870	126870	CIERRE HÉLICE	THRUST WASHER	CHIUSURA ELICA	RONDELLE FREIN
18	REC3852350	3852350	ESPACIADOR	SPACER	DISTANZIALE	CALE
19	REC3852056	306394	PASADOR	COTTER PIN	CHIAVISTELLO	GOUPILLE
20	REC398042	5008966	KIT TUERCA HÉLICE	NUT & KEEPER	KIT DADO	KIT ÉCROU D'HÉLICE

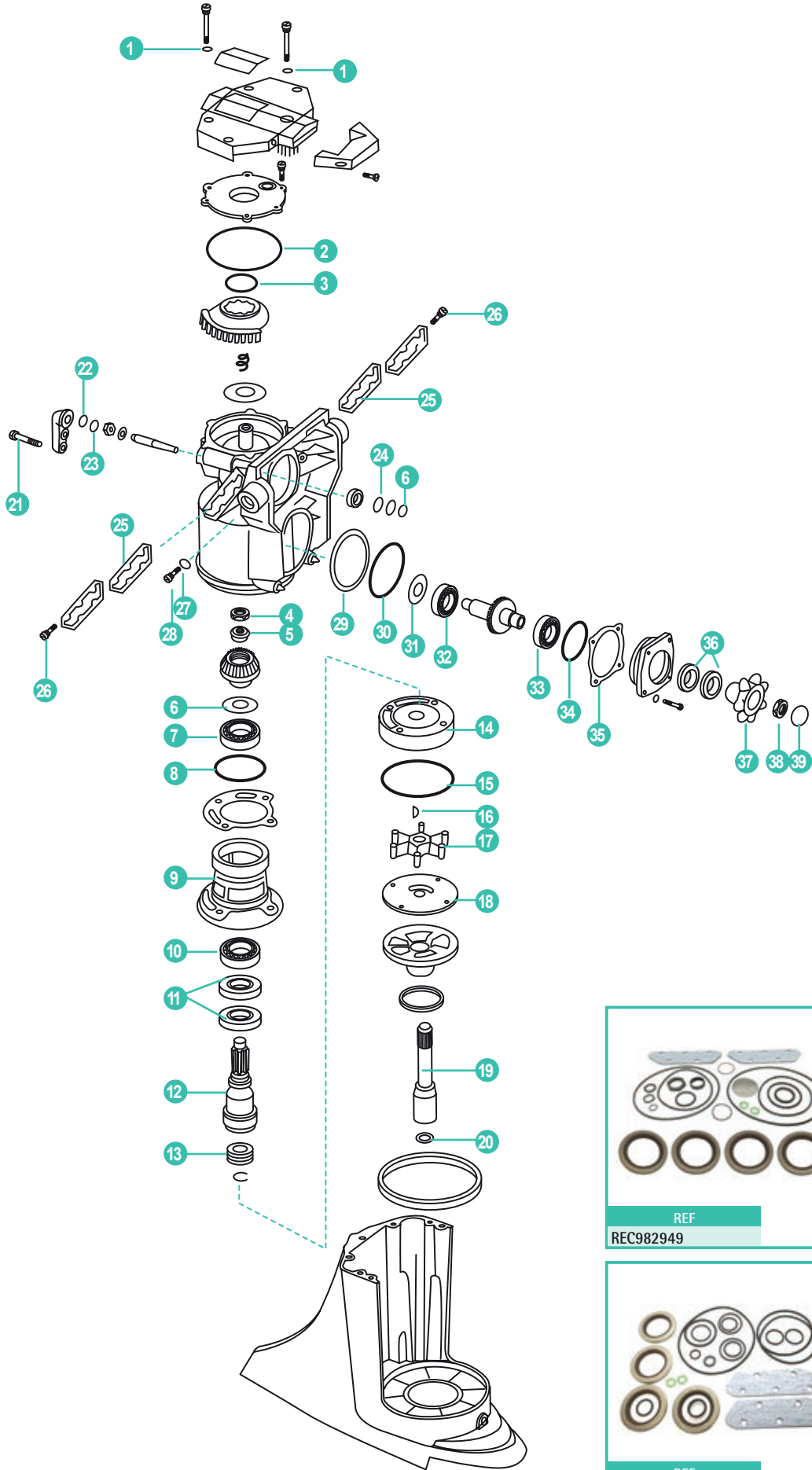

	REF	OEM				
1	REC315189	315189	JUNTA	GASKET	GUARNIZIONE	JOINT
2	REC313175	313175	ANILLO GOMA	O-RING	ANELLO IN GOMMA	JOINT EN CAOUTCHOUC
3	REC25-30224	310327	ANILLO GOMA (CAMBIO ELÉCTRICO)	O-RING (ELECTRIC SHIFT)	ANELLO IN GOMMA (CAMBIO ELETTRICO)	JOINT EN CAOUTCHOUC (CHANGEMENT ELECTRIQUE)
	REC25-30224	910582	ANILLO GOMA (400-800)	O-RING	ANELLO IN GOMMA (400-800)	JOINT EN CAOUTCHOUC (400-800)
4	REC907866	907866	CONTRATUERCA	LOCK NUT	CONTRO DADO	ÉCROU
5	REC909123	909123	TOPE PIÑÓN	CENTERING CONE	FERMO PIGNONE	CONE DE CENTRAGE
	REC313194	313193	SUPLEMENTO A .003	SHIM .003	SPESSORE .003	CALE .003
	REC313194	313194	SUPLEMENTO A .004	SHIM .004	SPESSORE .004	CALE .004
	REC313195	313195	SUPLEMENTO A .005	SHIM .005	SPESSORE .005	CALE .005
6	REC313196	313196	SUPLEMENTO A .006	SHIM .006	SPESSORE .006	CALE .006
	REC313197	313197	SUPLEMENTO A .007	SHIM .007	SPESSORE .007	CALE .007
	REC313198	313198	SUPLEMENTO A .008	SHIM .008	SPESSORE .008	CALE .008
	REC313199	313199	SUPLEMENTO A .009	SHIM .009	SPESSORE .009	CALE .009
	REC313200	313200	SUPLEMENTO A .010	SHIM .010	SPESSORE .010	CALE .010
7	REC379585	379585	COJINETES	BEARING	CUSCINETTO	ROULEMENT
8	REC553126	553126	ANILLO GOMA	O-RING	ANELLO IN GOMMA	JOINT EN CAOUTCHOUC
9	REC910240	910240	TAPA	BEARING HOUSING	COPERCHIO	COUVERCLE
10	REC382165	382165	COJINETE	BEARING	CUSCINETTO	ROULEMENT
11	REC981268	981268	RETÉN	OIL SEAL	PARAOLIO	JOINT SPI
	REC909121	909121	EJE TRANSMISIÓN	DRIVE SHAFT	ASSE TRASMISSIONE	ARBRE TRANSMISSION
12	REC981220	981220	EJE TRANSMISIÓN	DRIVE SHAFT	ASSE TRASMISSIONE	ARBRE TRANSMISSION
	REC382883	382883	EJE TRANSMISIÓN	DRIVE SHAFT	ASSE TRASMISSIONE	ARBRE TRANSMISSION
13	REC907774	907774	RETÉN EJE	SHAFT SEAL	TENUTA ASSE	JOINT D'HUILE ARBRE
14	REC983298	983298	CUERPO BOMBA AGUA	PUMP HOUSING	CORPO POMPA ACQUA	CORPS DE POMPE A EAU
15	REC910238	910238	ANILLO GOMA	O-RING	ANELLO	JOINT TORIQUE
16	REC308928	308924	CHAVETA	KEY	CHIAVETTA	CLAVETTE
17	REC777130	777130	IMPULSOR	IMPELLER	GIRANTE	TURBINE
18	REC313176	313176	TAPA BOMBA AGUA	PUMP PLATE	COPERCHIO POMPA ACQUA	COUVERCLE POMPA D'EAU
19	REC909753	909753	EJE CORTO BOMBA	SHORT DRIVE SHAFT	ASSE CORTO POMPA	ARBRE DE TRANSMISSION COURT
	REC908087	908087	EJE LARGO BOMBA	LONG DRIVE SHAFT	ASSE LUNGO POMPA	ARBRE DE TRANSMISSION LONG
20	REC314491	314491	ANILLO GOMA	O-RING	ANELLO	JOINT TORIQUE
21	REC305282	305282	TORNILLO	SCREW	VITE	VIS
22	REC125017	302540	ANILLO GOMA (ANTIGUO)	O-RING (EARLY MODEL)	ANELLO IN GOMMA (VECCHIO)	JOINT EN CAOUTCHOUC (ANCIEN)
	REC909140	909140	ANILLO GOMA (MODERNO)	O-RING (LATE MODEL)	ANELLO IN GOMMA (MODERNO)	JOINT EN CAOUTCHOUC (MODERNE)
23	REC909139	909139	RETÉN	QUAD RING	PARAOLIO	JOINT SPI
24	REC909048	909048	RETÉN	QUAD RING	PARAOLIO	JOINT SPI
25	REC308592	308592	JUNTA	GASKET	GUARNIZIONE	JOINT
26	REC328694	3852473	TORNILLO	SCREW	VITE	VIS
27	REC3855081	311598	JUNTA	GASKET	GUARNIZIONE	JOINT
28	REC22-67892A05	318544	JUEGO TORNILLOS	SCREW SET	KIT VITI	KIT VIS
29	REC308768	308768	RETÉN	SEAL	TENUTA	JOINT D'HUILE
30	REC308590	308590	MUELLE	SPRING	MOLLA	RESSORT
	REC313163	313163	SUPLEMENTO A .003	SHIM	SPESSORE .003	CALE .003
31	REC313164	313164	SUPLEMENTO A .004	SHIM	SPESSORE .004	CALE .004
	REC313167	313167	SUPLEMENTO A .007	SHIM	SPESSORE .007	CALE .007
32	REC375761	375761	COJINETE	BEARING	CUSCINETTO	ROULEMENT
33	REC382212	382212	COJINETES	BEARING	CUSCINETTO	ROULEMENT
34	REC25-35029	308621	ANILLO RETÉN	O-RING	ANELLO	JOINT D'HUILE
	REC313202	313202	SUPLEMENTO A .002	SHIM	SPESSORE .002	CALE .002
	REC313203	313203	SUPLEMENTO A .003	SHIM	SPESSORE .003	CALE .003
35	REC313204	313204	SUPLEMENTO A .004	SHIM	SPESSORE .004	CALE .004
	REC313205	313205	SUPLEMENTO A .005	SHIM	SPESSORE .005	CALE .005
	REC313206	313206	SUPLEMENTO A .006	SHIM	SPESSORE .006	CALE .006
36	REC981196	981196	RETÉN	OIL SEAL	PARAOLIO	JOINT D'HUILE
37	REC908069	908069	ENGRANAJE	BALL GEAR	INGRANAGGIO	ENGRENAGE
38	REC908064	908064	TUERCA	NUT	DADO	ÉCROU
39	REC908062	908062	TAPA	COVER	COPERCHIO	COUVERCLE

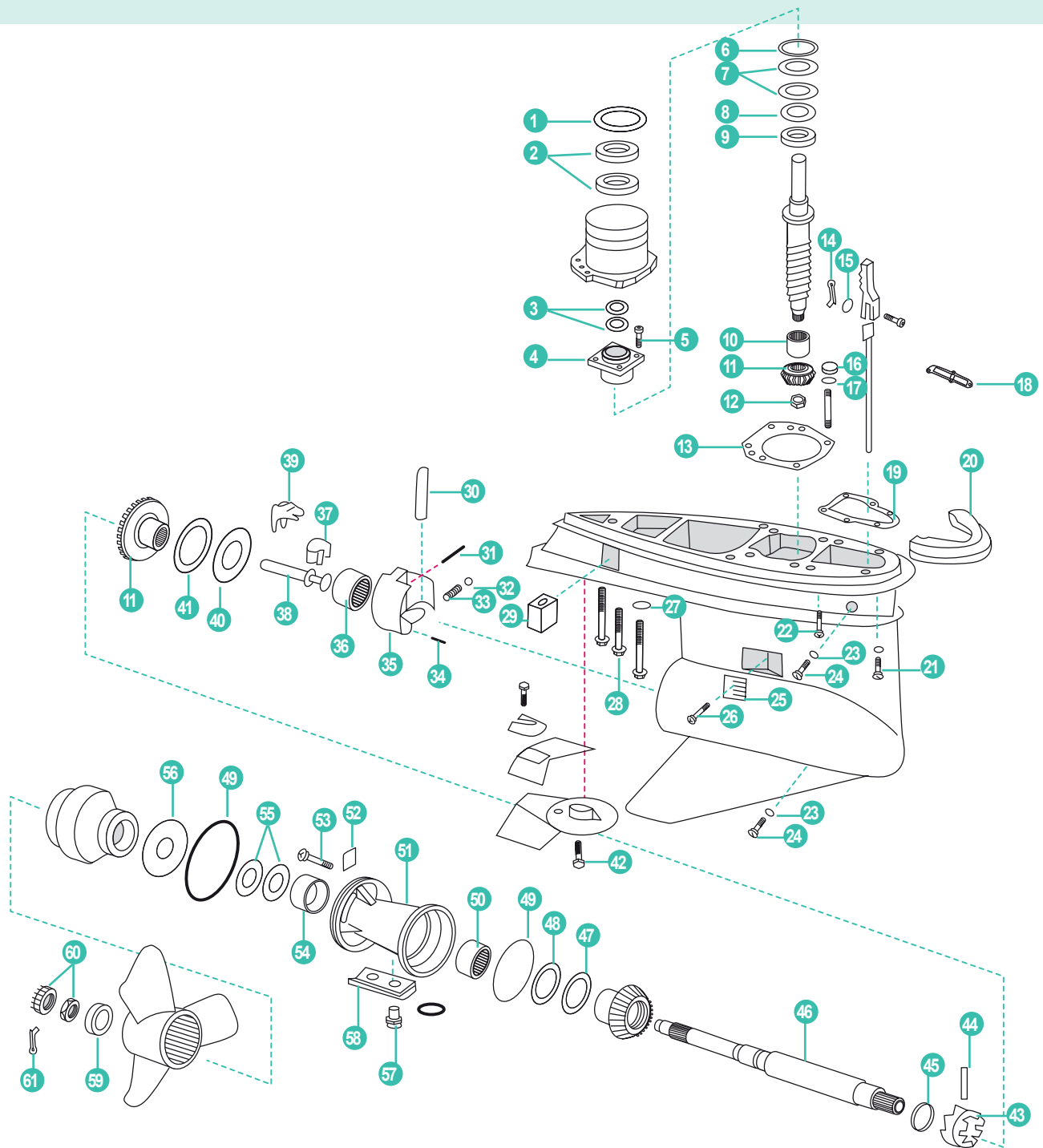

REF	OEM				
1	PAGB/T848-6	305981	ARANDELA	O-RING	RONDELLA RONDELLE
2	REC310649	310649	RETÉN	OIL SEAL	PARAOLI JOINT D'HUILE
3	REC321467	321467	RETÉN	OIL SEAL	PARAOLIO JOINT D'HUILE
4	REC982422	982422	TAPA RETENES	BEARING & HG SEAL	COPERCHIO PARAOLIO COUVERCLE JOINTS D'HUILE
5	REC317624	317624	TORNILLO	SCREW	VITE VIS
6	REC314728	314728	ANILLO GOMA	O-RING	ANELLO JOINT TORIQUE
	REC314745	314745	SUPLEMENTO.005	SHIM	SPESSORE .005 CALE .005
7	REC323361	323361	SUPLEMENTO.004	SHIM	SPESSORE .004 CALE .004
	REC323362	323362	SUPLEMENTO.003	SHIM	SPESSORE .003 CALE .003
8	REC327656	327656	TOPE ARANDELA	THRUST WASHER	FERMO RONDELLA RONDELLE
9	REC387656	387656	TOPE COJINETE	THRUST BEARING	FERMO CUSCINETTO FREIN DE ROULEMENT
	REC387817	387817	COJINETE	PINION BEARING	CUSCINETTO ROULEMENT
10	REC384195	384195	COJINETE GM 4CIL	PINION BEARING	CUSCINETTO GM 4 CIL ROULEMENT GM 4CYL
11	REC320635	5004941	KIT COMPLETO PIÑONES 5,0,5,8-V8	P/FORWARD GEAR SET 5,0, 5,8-V8	KIT PIGNONI COMPLETO 5,0, 5,8 - V8 KIT PIGNONS AVANT

	REF	OEM				
12	REC11-35921	314730	TUERCA	NUT	DADO	ÉCROU
13	REC910236	910236	JUNTA	GASKET	GUARNIZIONE	JOINT
	REC338484	910338	JUNTA GM 4 CIL.	GASKET	GUARNIZIONE GM 4 CYL	JOINT GM 4 CYL
14	REC306376	306376	PASADOR	COTTER PIN	CHIAVISTELLO	GOUPILLE
15	REC328702	306358	ARANDELA	WASHER	RONDELLA	RONDELLE
16	REC11-8267089	121731	TUERCA	NUT	DADO	ÉCROU
17	REC313353	313353	RETÉN	OIL SEAL	PARAOLI	JOINT D'HUILE
18	REC909604	909604	JUNTA	GASKET	GUARNIZIONE	JOINT
19	REC324670	352165	JUNTA	GASKET	GUARNIZIONE	JOINT
20	CM983494	983494	ANODO	ANODE	ANODO	ANODE
21	REC912127	912127	TORNILLO	SCREW	VITE	VIS
22	REC331999	331999	TORNILLO 3/8X1 3/4-16	SCREW 3/8 X 1 3/4-16	VITE 3/8 X 1 3/4-16	VIS 3/8 X 1 3/4 - 16
23	REC3855081	311598	JUNTA	GASKET	GUARNIZIONE	JOINT
24	REC22-67892A05	318544	TORNILLO CON RETÉN	DRAINING SCREW	BULLONE CON ANELLO	BOUCHON DE VIDANGE MAGNETIQUE + JOINT
25	REC337778	337778	REJILLA	SCREEN	GRIGLIA	GRILLE
26	REC337061	337061	TORNILLO	SCREW	BULLONE	VIS
27	REC330265	330265	ARANDELA	LOCK WASHER	RONDELLA	RONDELLE
28	REC328096	328096	TORNILLO	SCREW	VITE	VIS
29	CM393023	436745	ANODO	ANODE	ANODO	ANODE
30	REC910310	910310	EJE RETENEDOR	PIN	ASSE RITENITORE	ARBRE DE RETENUE
31	REC328825	328825	PASADOR	PIN	CHIAVISTELLO	GOUPILLE
	REC313448	320145	PASADOR 4 CIL	PIN	CHIAVISTELLO 4 CIL	GOUPILLE 4 CYL
32	REC160084	160084	BOLA	DETENT BALL	BOLLA	BOULE
33	REC911962	911962	MUELLE	SPRING	MOLLA	RESSORT
34	REC331880	331880	PASADOR	PIN	CHIAVISTELLO	GOUPILLE
35	REC389455	389455	TAPA COJINETE	HSNG & BRING ASSY.	COPERCHIO CUSCINETTO	COUVERCLE ROULEMENT
36	REC389039	389039	COJINETE	BEARING	CUSCINETTO	ROULEMENT
	REC382407	382407	COJINETE 4 CIL	BEARING	CUSCINETTO	ROULEMENT 4 CYL
37	REC334163	982422	REGULADOR EJE	CRADLE	REGOLATORE ASSE	REGULATEUR D'ARBRE
38	REC322941	322941	EJE	SHAFT	ASSE	ARBRE
39	REC322938	322938	UÑA DESPLAZABLE	LEVER	CHIAVETTA	CROCHET
40	REC327669	327669	TOPE ARANDELA	THRUST WASHER	FERMO RONDELLA	RONDELLE FREIN
	REC324766	324766	TOPE ARANDELA 4 CIL	THRUST WASHER	FERMO RONDELLA 4 CIL	RONDELLE FREIN 4 CYL
41	REC389042	389042	TOPE COJINETE	THRUST BEARING	FERMO CUSCINETTO	FREIN ROULEMENT
	REC385043	385043	TOPE COJINETE 4 CIL	THRUST BEARING	FERMO CUSCINETTO 4 CIL	FREIN ROULEMENT 4 CYL
42	REC313715	313715	TORNILLO	SCREW	VITE	VIS
43	REC337774	337774	DESPLAZABLE	CLUTCH DOG	SCORREVOLE	CRABOT
	REC323664	323664	DESPLAZABLE	CLUTCH DOG	SCORREVOLE	CRABOT
44	REC313448	313448	PASADOR DESPLAZABLE	CROSS PIN	CHIAVISTELLO SCORREVOLE	GOUPILLE DU CRABOT
45	REC324369	324369	MUELLE	SPRING	MOLLA	RESSORT
46	REC395209	395209	EJE HÉLICE 800 MOD.	PROP SHAFT	ASSE ELICA 800	ARBRE D'HÉLICE 800
	REC436888	436888	EJE HÉLICE 1976-86	PROP SHAFT	ASSE ELICA 1976-86	ARBRE D'HÉLICE 1976-86
47	REC382408	382408	TOPE COJINETE	THRUST BEARING	FERMO CUSCINETTO	FREIN DE ROULEMENT
48	REC314731	314731	TOPE ARANDELA	THRUST WASHER	FERMO RONDELLA	RONDELLE FREIN
49	REC305123	305123	ARO	O-RING	ANELLO	JOINT TORIQUE
	REC313446	313446	ARO 4 CIL	O-RING	ANELLO 4 CYL	JOINT TORIQUE4 CYL
50	REC382407	382407	COJINETE	BEARING	CUSCINETTO	ROULEMENT
51	REC5000074	5000074	COJINETE DIÁBOLO	BEARING CARRIER	CUSCINETTO DIAVOLO	DIABOLO
52	REC333957	333957	PESTAÑA SUJECCIÓN	TAB	TAB	BAGUE DE RETENUE
53	REC350271	350271	TORNILLO	SCREW	VITE	VIS
54	REC387247	387247	COJINETE	BEARING	CUSCINETTO	ROULEMENT
	REC379504	379504	COJINETE 4 CIL	BEARING	CUSCINETTO 4 CIL	ROULEMENT 4 CYL
55	REC26-76868	320862	RETÉN	OIL SEAL	PARAOLIO	JOINT D'HUILE
	REC330137	330137	RETÉN 4 CIL	OIL SEAL	PARAOLIO 4 CIL	JOINT D'HUILE 4 CYL
56	REC126870	126870	TOPE ARANDELA (800)	THRUST WASHER	FERMO CUSCINETTO 800	RONDELLE FREIN 800
	REC127084	127084	TOPE ARANDELA 4 CIL	THRUST WASHER	FERMO CUSCINETTO 4 CIL	RONDELLE FREIN 4 CYL
57	REC908158	908158	TORNILLO	SCREW	VITE	VIS
58	CM431708	431708	ANODO	ANODE	ANODO	ANODE
59	REC320570	320570	TOPE HÉLICE (800)	SPACER	FERMO ELICA 800	RONDELLE BUTEE D'HELICE 800
	REC315810	315810	TOPE HÉLICE (400)	SPACER	FERMO ELICA 400	RONDELLE BUTEE D'HELICE400
60	REC314503	5008966	TUERCA 4 CIL	NUT	DADO 4 CIL	ÉCROU 4CYL
	REC398042	398042	TUERCA (800)	NUT	DADO 800	ÉCROU 800
	REC314502	314502	PASADOR 4 CIL	PIN	CHIAVISTELLO 4 CIL	GOUPILLE 4 CYL
61	REC3852056	306394	PASADOR (800)	PIN	CHIAVISTELLO 800	GOUPILLE 800

**TRANSOM
COBRA (1986-93)**



REF
REC915840

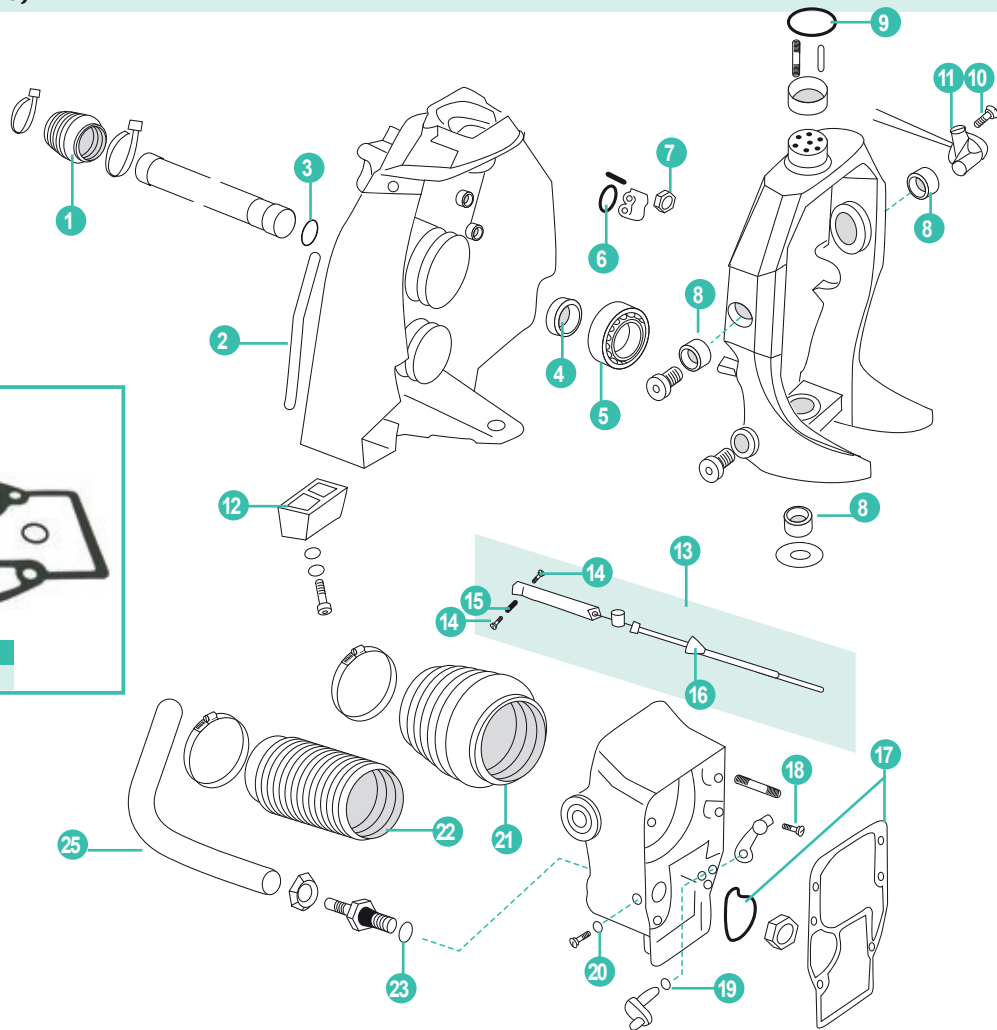

REF	OEM					
1	CEF500506	911826	FUELLE CABLE CAMBIO	SHIFT CABLE BELLOW	CUFFIA CAVO CAMBIO	SOUFFLET CABLE CHANGEMENT
2	REC3852550	3852550	JUNTA TRANSOM	GASKET	GUARNIZIONE	JOINT
3	REC309731	911871	ARO	O-RING	ANELLO	JOINT TORIQUE
4	REC3852548	3852548	RETÉN TRASERO	REAR SEAL	PARAOLIO POSTERIORE	JOINT D'HUILE ARRIERE
5	REC30-879194A01	3853807	COJINETE TRANSOM	GIMBAL BEARING	CUSCINETTO TRANSOM	ROULEMENT TRANSOM
6	REC331188	322501	ARO	O-RING	ANELLO	JOINT TORIQUE
7	REC11-8267089	121731	TUERCA	LOCK NUT	DADO	ÉCROU
8	REC3808228	3852544	CASQUILLO	PIVOT PIN BEARING	BOCCOLA	BAGUE
9	REC25-33145	302337	ARO	O-RING	ANELLO	JOINT TORIQUE
10	REC308825	308825	TORNILLO	SCREW	VITE	VIS
11	RM3850470	3850470	SENSOR TRIM	TRIM SONDE	SENSORE TRIM	CAPTEUR TRIM
12	TEN00919	3853930	ANODO	ANODE	ANODO	ANODE
13	REC987661	987661	CABLE CAMBIO COBRA	SHIFT CABLE ASSEMBLY	CAVO CAMBIO COBRA	CÂBLE CHANGEMENT COBRA
	REC987678	987678	CABLE CAMBIO KING COBRA	SHIFT CABLE ASSEMBLY (KING COBRA)	CAVO CAMBIO KING COBRA	CÂBLE CHANGEMENT KING COBRA
14	REC10-20518	912304	TORNILLO	SET SCREW	VITE	VIS
15	REC43436	915918	ANCLAJE	ANCHOR	FERMO	ANCRAGE
16	REC304174	304174	ARO TORICO	O-RING	ANELLO	JOINT TORIQUE
17	REC915840	915840	KIT DE JUNTAS	GASKET SET	KIT GUARNIZIONE	KIT DE JOINTS
18	REC908158	908158	TORNILLO	SCREW	VITE	VIS
19	REC25-48171	202893	ARO TORICO	O-RING	ANELLO	JOINT TORIQUE
20	REC332583	911311	ARO	O-RING	ANELLO	JOINT TORIQUE
21	REC3841481	3854127	FUELLE TRANSOM	U-JOINT BELLOW	CUFFIA TRANSOM	SOUFFLET DE CARDAN
	CEF500514K	3854127	FUELLE TRANSOM	U-JOINT BELLOW	CUFFIA TRANSOM	SOUFFLET DE CARDAN
22	REC914036	914036	FUELLE ESCAPE	EXHAUST BELLOW	CUFFIA SCARICO	SOUFFLET D'ÉCHAPPEMENT
	CEF500527K	914036	FUELLE ESCAPE	EXHAUST BELLOW	CUFFIA SCARICO	SOUFFLET D'ÉCHAPPEMENT
23	REC3852535	911718	ARO	O-RING	ANELLO	JOINT TORIQUE
24	REC3852352	911830	TUBO SUBIDA AGUA	TRIM HOSE UP	TUBO ACQUA	DURITE D'EAU

TRANSON ANTIGUO

INTERMEDIATE HOUSING-
STRINGER MOUNT

TRANSON VECCHIO

TRANSON ANCIEN

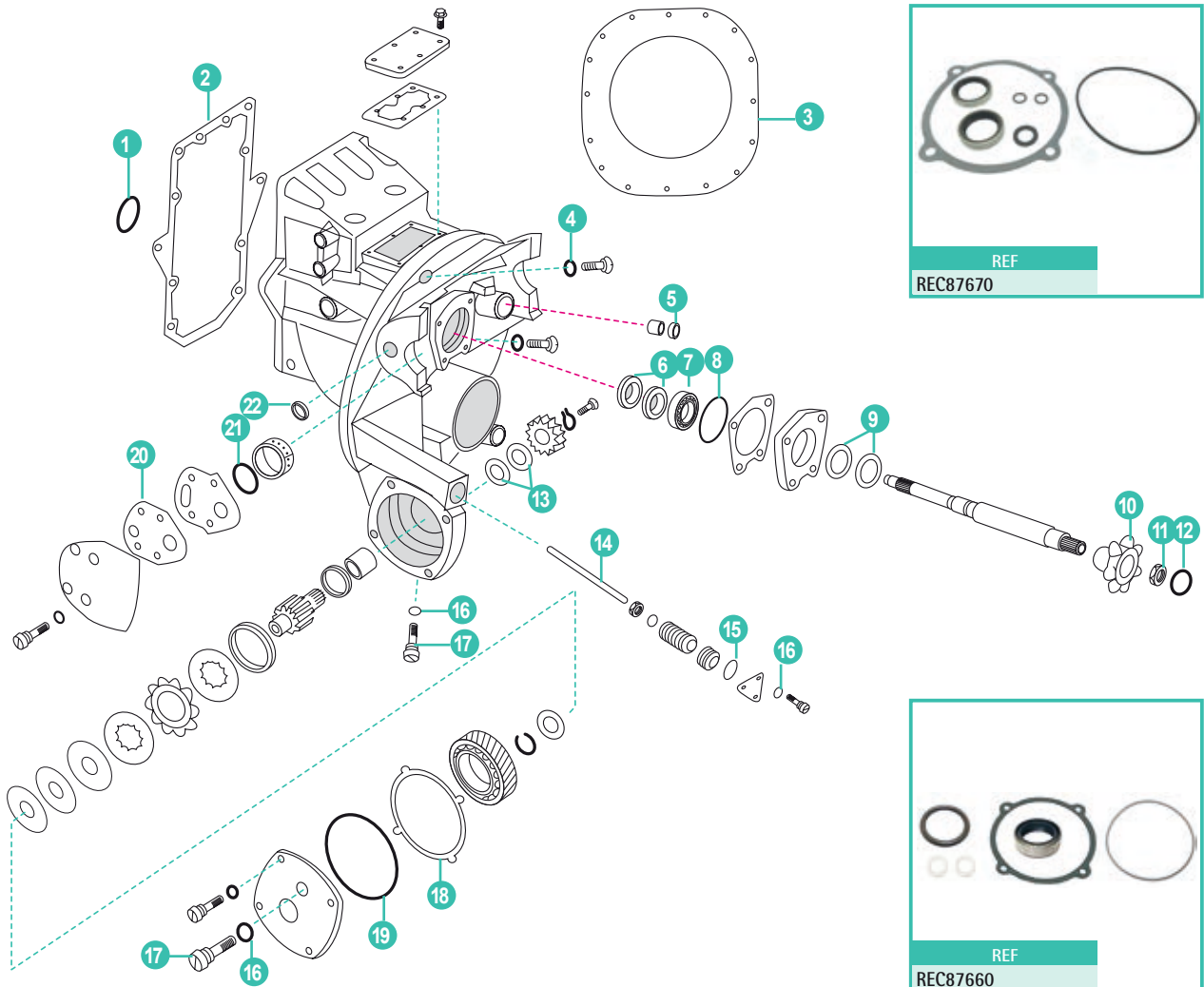

	REF	OEM				
1	REC25-33145	302337	ARO GOMA	O-RING	ANELLO	JOINT TORIQUE
2	REC909515	909515	JUNTA	GASKET	GUARNIZIONE	JOINT
3	REC313080	313080	GOMA TRANSON 120HP (1967-77)	PLATE SEAL 120 HP (1967-77)	GOMMA TRANSON 120 HP (1967-77)	JOINT DE TRANSON120HP (1967-77)
	REC909527	909527	GOMA TRANSON (1978-86)	PLATE SEAL (1978-86)	GOMMA TRANSON (1978-86)	JOINT DE TRANSON(1978-86)
4	REC315189	315189	JUNTA	GASKET	GUARNIZIONE	JOINT
5	REC908855	908855	RETÉN	OIL SEAL	PARAOLIO	JOINT D'HUILE
6	REC26-419533	764337	RETÉN	OIL SEAL	PARAOLIO	JOINT D'HUILE
7	REC31-86748A1	3854250	COJINETE	BEARING	CUSCINETTO	ROULEMENT
8	REC908383	908383	ARO	O-RING	ANELLO	JOINT TORIQUE
9	REC981195	981195	RETÉN	OIL SEAL	PARAOLIO	JOINT D'HUILE
10	REC908063	908063	ENGRANAJE	BALL GEAR	INGRANAGGIO	ENGRENAGE
11	REC908064	908064	TUERCA	NUT	DADO	ÉCROU
12	REC908062	908062	TAPA	COVER	COPERCHIO	COUVERCLE
13	REC321467	321467	RETÉN	OIL SEAL	PARAOLIO	JOINT D'HUILE
14	REC980183	980183	EJE ELEVADOR	TILT SHAFT	ALBERINO	ARBRE DE TILT
15	REC125017	302540	ARO	O-RING	ANELLO	JOINT TORIQUE
16	REC3855081	311598	JUNTA	GASKET	GUARNIZIONE	JOINT
17	REC10-79953Q04	307551	TORNILLO	SCREW	VITE	VIS
18	REC308799	308799	JUNTA	GASKET	GUARNIZIONE	JOINT
19	REC908194	908194	ARO GOMA	O-RING	ANELLO	JOINT TORIQUE
20	REC323338	316499	JUNTA CAMBIO ELECTRÓNICO	ELEC. SHIFT GASKET	GUARNIZIONE CAMBIO ELETTRONICO	JOINT CHANGEMENT ELECTRONIQUE
21	REC25-457101	308626	ARO GOMA	O-RING	ANELLO	JOINT TORIQUE
22	REC313244	313244	JUNTA	GASKET	GUARNIZIONE	JOINT

KITS REPARACIÓN

REPAIR KITS

KIT RIPARAZIONE

KITS DE RÉPARATION

COLAS

DRIVES

PIEDI

EMBASES

REF	OEM
REC915840	915840



REF	OEM	Image
REC981801	981801	

100 - 245 (1968-72)

400-800

REF	OEM	Image
REC981797	981797	

100 - 245 (1968-77)
Cambio eléctrico | electric shift | cambio elettrico | changement électrique

REF	OEM	Image
REC982946	982946	

V6-V8 (1978-86)
Cambio mecánico | mechanic shift | cambio meccanico | changement mécanique

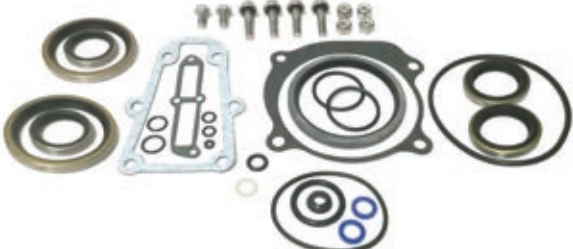
REF	OEM	Image
REC982947	982947	

4 Cil. (1978-86)
Cambio mecánico | mechanic shift | cambio meccanico | changement mécanique

GOMAS TRANSOM

PLATE SEAL

GOMMA TRANSOM

JOINT DE TRANSOM

REF	OEM	Image
REC313080	982946	
REC909527	909527	

(1967-77) 120 HP+
(1978-86)

TRANSOM

KIT	REF	OEM	ARO	O-RING	ANELLO	BAGUE
	REC125017	302540	ARO	O-RING	ANELLO	BAGUE
	REC308799	308799	JUNTA	GASKET	GAURNIZIONE	JOINT
REC87660	REC12-191833	311598	ARANDELA	WASHER	RONDELLA	RONDELLE
	REC908194	908194	ARO	O-RING	ANELLO	BAGUE
	REC911019	911019	RETÉN	OIL SEAL	PARAOLIO	OINT SPI



KIT	REF	OEM	ARO	O-RING	ANELLO	BAGUE
	REC125017	302540	ARO	O-RING	ANELLO	BAGUE
	REC308799	308799	JUNTA	GASKET	GAURNIZIONE	JOINT
REC87670	REC3855081	311598	ARANDELA	WASHER	RONDELLA	RONDELLE
	REC908194	908194	ARO	O-RING	ANELLO	BAGUE
	REC321467	321467	RETÉN	OIL SEAL	PARAOLIO	OINT SPI



EJES BOMBA AGUA **WATER PUMP SHAFT** **ASSE POMPA ACQUA** **ARBRE POMPE D'EAU**

REF	OEM
REC909753	909753
REC908087	908087



KIT BOMBA AGUA **WATER PUMP KIT** **KIT POMPA ACQUA** **KIT POMPE D'EAU**

KIT	OEM	REF	OEM					
REC879031	983218	100 - 260 (1962-85) ⊘ COBRA	REC310584	310584	ARO	O-RING	ANELLO	BAGUE
			REC25-30613	310585	ARO	O-RING	ANELLO	JOINT
			REC313176	313178	TAPA BOMBA	PUMP PLATE	COPERCHIO POMPA	RONDELLE
			REC314491	314491	ARO	O-RING	ANELLO	BAGUE
			REC777130	379475	TURBINA	IMPELLER	GIRANTE	TURBINE
			REC907774	907774	RETÉN	OIL SEAL	PARAOLIO	JOINT SPI
			REC910238	910238	ARO	O-RING	ANELLO	BAGUE
			REC983298	983298	CARCASA	PUMP HOUSING	CARCASSA POMPA	CARCASSE



JUNTAS **GASKETS** **GUARNIZIONE** **JOINTS**

VARILLA ACEITE **DIPSTICK** **ASTICELLA DELL'OLIO** **TIGE D'HUILE**

REF	OEM
REC315189	315189



CIERRE COBRA **OUTDRIVE SEAL COBRA** **CHIUSURA COBRA** **FERMETURE COBRA**

REF	OEM
REC3852560	3852560



SALIDA AGUA **WATER OUTLET** **PASSAGGIO DELL ACQUA** **SORTIE D'EAU**

REF	OEM
REC27-8146801	311069
	3789161GM



CAMBIO MECÁNICO **SWIVEL BRG. MECH SHIFT** **CAMBIO MECCANICO** **CHANGEMENT MECANIQUE**

REF	OEM
REC338484	910338
	324701
	338484



CAMBIO ELECTRÓNICO **SWIVEL BRG. ELECT. SHIFT** **CAMBIO ELETTRONICO** **CHANGEMENT ELECTRONIQUE**

REF	OEM
REC313386	313368



RETENES

SEALS

PARAOILIO

JOINTS SPI

GUÍA AROS TÓRICOS

O'RING GUIDE

GUIDA TENUTE

GUIDE JOINTS SPI

REF.	OEM	Ø INT	Ø EXT	GRUESO THICK SPESSORE ESPESEUR
REC25-48171	202893	3/8	1/2	1/16
REC301877	301877	3 ^{1/128}	73/128	2 ^{1/128}
REC301967	301967	1 ^{3/16}	1	3/32
REC25-33145	302337	2	2 ^{1/4}	1/8
REC302537	302537	1 ^{3/8}	1 ^{9/16}	3/32
REC125017	302540	1	1 ^{1/4}	1/8
REC302588	302588	1 ^{3/4}	2	1/8
REC3852045	303067	3/8	9/16	3/32
REC25-62702	303191	5/16	7/16	1/16
REC303347	303347	7/16	5/8	3/32
REC25-35027	303360	1 ^{1/16}	1 ^{5/16}	1/8
REC304174	304174	1/2	5/8	1/16
REC305123	305123	3 ^{3/4}	4	1/8
REC305242	305242	5/16	9/16	1/8
REC3852928	305270	1 ^{5/8}	1 ^{7/8}	1/8
REC332583	305739	1/4	3/8	1/16
REC25-80863	307082	2 ^{5/8}	2 ^{7/8}	1/8
REC307450	307450	7/16	9/16	1/16
REC25-38933	307853	7/32	1 ^{1/32}	1/16
REC25-35029	308621	3 ^{1/8}	3 ^{3/8}	1/8
REC25-29845	308624	1 ^{5/16}	1 ^{1/8}	3/32
REC25-457101	308626	1 ^{7/16}	1 ^{5/8}	3/32
REC308627	308627	2 ^{1/4}	2 ^{1/2}	1/8
REC308876	308876	2 ^{1/4}	2 ^{7/16}	3/32
REC309731	309731	1 ^{3/16}	1 ^{3/8}	3/32
REC310414	310141	3 ^{5/8}	3 ^{7/8}	1/8
REC25-30224	310327	1 ^{7/8}	2 ^{1/8}	1/8
REC310414	310414	3 ^{5/8}	3 ^{7/8}	1/8
REC310584	310584	3/4	1	1/8
REC25-30613	310585	3/4	1 ^{5/16}	3/32
REC25-30613	310967	3/4	1 ^{5/16}	3/32
REC25-62705	311338	3/4	7/8	1/16
REC313175	313175	4 ^{3/4}	5	1/8
REC313340	31340	1 ^{11/16}	1 ^{7/8}	3/32
REC967344	313446	3 ^{3/8}	3 ^{5/8}	1/8
REC313754	313754	1 ^{7/8}	2 ^{1/16}	3/32
REC314491	314491	1	1 ^{1/8}	1/16
REC314728	314728	2 ^{1/8}	2 ^{5/16}	3/32
REC332583	317178	1/4	3/8	1/16
REC318372	318372	8 mm	16 mm	4 mm

REF.	OEM	Ø INT	Ø EXT	GRUESO THICK SPESSORE ESPESEUR
REC318717	318717	1 ^{1/2}	1 ^{7/8}	3/16
REC319085	319085	1 ^{1/8}	1 ^{1/2}	3/16
REC925093	320303	2 ^{3/4}	3	1/8
REC25-38933	321117	3/16	5/16	1/16
REC331188	322501	1 ^{5/16}	1 ^{1/2}	3/32
REC25-38933	322598	7/32	1 ^{1/32}	1/16
REC326649	326649	5/8	1 ^{3/16}	3/32
REC326741	326741	4 ^{1/2}	4 ^{3/4}	1/8
REC326849	326849	4 ^{1/4}	4 ^{1/2}	1/8
REC301877	326956	3 ^{1/128}	7 ^{3/128}	2 ^{1/128}
REC301877	326959	3 ^{1/128}	7 ^{3/128}	2 ^{1/128}
REC326649	329380	5/8	1 ^{3/16}	3/32
REC3852045	329381	3/8	9/16	3/32
REC332583	332583	1/4	3/8	1/16
REC332583	332584	1/4	3/8	1/16
REC333572	333572	1/4	7/16	3/32
REC338518	338518	2 ^{9/16}	2 ^{3/4}	3/32
REC338522	338522	1 ^{5/8}	1 ^{13/16}	3/32
REC339543	339543	1/2	1 ^{1/16}	3/32
REC25-25439	3852565	7/8	11 ^{1/16}	3/32
REC553126	553126	3 ^{1/4}	3 ^{1/2}	1/8
REC908194	908194	4	4 ^{3/16}	3/32
REC908383	908383	2 ^{1/2}	2 ^{11/16}	3/32
REC326649	909047	5/8	1 ^{3/16}	3/32
REC909048	909048	1/2	1 ^{1/16}	3/32
REC909139	909139	1	1 ^{1/4}	1/8
REC909140	909140	1 ^{1/16}	1 ^{13/16}	1/16
REC909316	909316	1 ^{1/2}	1 ^{11/16}	3/32
REC3852045	909747	5/16	1/2	3/32
REC910238	910238	5 ^{1/4}	5 ^{1/2}	1/8
REC25-30224	910582	1 ^{7/8}	2 ^{1/8}	1/8
REC332583	911311	1/4	3/8	1/16
REC25-70937	911686	3 ^{1/2}	3 ^{3/4}	1/8
REC911700	911700	4 ^{1/8}	4 ^{3/8}	1/8
REC3852535	911718	1 ^{1/16}	1 ^{1/4}	3/32
REC309731	911871	1 ^{3/16}	1 ^{3/8}	3/32

GUÍA RETENES ACEITE

OIL SEAL GUIDE



GUIDA PARAOILIO







GUIDE JOINTS SPI

REF.	OEM	EJE SHAFT SIZE ASSE ARBRE	CALIBRE BORE SIZE CALIBRE ASDFASD
REC302564	302564	0.7813	1.3750
REC303345	303345	0.5625	1.0000
REC767970	305987	1.0000	1.3750
REC309989	309989	1.3750	2.0000
REC310599	310599	1.0000	1.5000
REC310649	310649	2.5000	3.0000
REC313282	313282	0.5540	1.0625
REC313284	313284	0.6250	1.1250
REC313353	313353	1.9375	2.4375
REC26-419533	313392	1.1875	1.8750
REC314167	314167	0.4219	0.9375
REC341281	314218	1.2500	1.6875
REC341281	314281	1.2500	1.6875
REC318972	318972	0.500000	0.8750
REC29-47270	318972	0.5000	0.8750
REC26-76868	320862	1.1875	1.6875
REC26-69188	321453	0.8750	1.2500
REC321459	321459	0.6250	1.1250
REC321466	321466	0.7500	1.1250
REC321467	321467	1.0000	1.3750
REC321480	321480	0.5000	1.2500
REC321481	321481	0.6875	1.2500
REC321786	321786	0.6250	1.1250
REC321787	321787	0.6250	1.1250
REC321788	321788	0.5000	1.0000
REC321831	321831	0.7500	1.2500

REF.	OEM	EJE SHAFT SIZE ASSE ARBRE	CALIBRE BORE SIZE CALIBRE ASDFASD
REC321895	321895	1.6250	1.9219
REC321928	321928	0.6250	1.3750
REC324639	324639	0.4375	0.9375
REC327031	327031	0.4375	0.8750
REC26-76868	3286	1.1875	1.6875
REC329922	329922	0.8750	1.3750
REC329923	329923	0.8750	1.3750
REC330137	330137	1.2500	1.6250
REC330327	330327	0.6250	1.1250
REC331103	331103	1.1250	1.6250
REC342786	332205	0.7500	1.1250
REC332261	332261	0.6250	1.3750
REC334950	334950	1.2500	1.6875
REC339620	339620	1.6250	2.1250
REC341280	341280	0.8750	1.3750
REC353076	353076	1.6250	2.0625
REC3852272	3852272	45 mm	75 mm
REC3853655	3853655	0.5000	0.9062
REC853868	3853858	25 mm	35 mm
REC908855	908855	0.6250	1.0000
REC911019	911019	1.0000	2.5000
REC911685	911685	2.0000	2.5000
REC981195	981195	1.5000	2.1250
REC981196	981196	1.7500	2.5000
REC981268	981268	1.6250	2.5000

APLICACIÓN DE RETENES COBRA		COBRA SEALS APPLICATIONS		APPLICAZIONI PARAOLI COBRA		GUIDE JOINTS SPI COBRA	
		REF				CANTIDAD QUANTITY QUANTITÀ QUANTITÈ	
TRANSOM							
262 - 460	1988-90	REC3852548	EJE	DRIVESHAFT	ASSE	ARBRE	1
PARTE SUPERIOR UPPER GEARCASE PARTE SUPERIORE PARTIE SUPÉRIEURE							
262 - 460	1988-90	REC911685	COJINETE	BEARING CARRIER	CUSCINETTO	ROULEMENT	1
350 - 460	1988-90	REC3853655	EJE BOMBA	PUMP SHAFT	ASSE POMPA	ARBRE POMPE	1
2.3 L - 7.5 L	1986-88	REC3853655	EJE BOMBA	PUMP SHAFT	ASSE POMPA	ARBRE POMPE	1
2.3 L - 7.5 L 5.7 L (1990) 574 AMPWS, ARPWS	1986-90	REC911685	COJINETE	BEARING CARRIER	CUSCINETTO	ROULEMENT	1
PARTE INFERIOR LOWER GEARCASE PARTE INFERIORE PARTIE INFÉRIEURE							
262 - 460	1988-89	REC26-76868	EJE HÉLICE	PROP SHAFT	ASSE ELICA	ARBRE HÉLICE	2
2.3 L	1990	REC330137	EJE HÉLICE	PROP SHAFT	ASSE ELICA	ARBRE HÉLICE	2
2.3 L - 3.0 L	1986-89	REC330137	EJE HÉLICE	PROP SHAFT	ASSE ELICA	ARBRE HÉLICE	2
3.0 L	1990	REC26-76868	EJE HÉLICE	PROP SHAFT	ASSE ELICA	ARBRE HÉLICE	2
4.3 L - 7.5 L	1986-90	REC26-76868	EJE HÉLICE	PROP SHAFT	ASSE ELICA	ARBRE HÉLICE	2

GUÍA CORREAS			V-BELTS GUIDE		GUIDA CINGHIE		GUIDE COURROIES	
			BOMBA AGUA WATER PUMP POMPA ACQUA POMPA D'EAU	DIRECCIÓN HIDRÁULICA POWER STEERING IDROGUIDA DIRECTION HYDRAULIQUE	ALTERNADOR ALTERNATOR ALTERNATORE ALTERNATEUR	REF	OEM	
120	165	190						
140	170	235						
145	175	240						
			✓		✓	REC3852106	311606	
4 151			✓		✓	REC829207	310953	
140			✓		✓	REC829207	310953	
155	225	245						
185	230	250						
210	235	260	✓		✓	REC3858462	311046	
215	240							
V-6, V-8								
165			1972-76	✓	✓	REC3852106	311606	
165C, 165S				✓	✓	REC3858462		
40-1/4"				✓				
165C, 165S				✓	✓	REC966382		
43-3/4"				✓				
170			1974	✓	✓	REC3852106	311606	
175			1975-77	✓	✓	REC3852106	311606	
				✓	✓	REC3858462	311046	
185			1978-84	✓	✓	REC829207	909971	
				✓	✓	REC829207	909971	
190			1974-77	✓	✓	REC3852106	311606	
190				✓				
225				✓		REC3858462		
44-1/4"				✓	✓	REC3858462	311046	
200			1979-81	✓	✓	REC829207	909971	
				✓	✓	REC829207	909971	
210			1970-71	✓	✓	REC3858462	311046	
215				✓	✓	REC966382		
				✓		GDY17335		
V-8 302 Ford			1971	✓	✓	REC3858462	311046	
225			1972-84	✓	✓	REC3858462	311046	
250			1973	✓	✓	REC3858462	311046	
				✓	✓	REC3858462	311046	
			1979-81	✓	✓	REC829207	909971	
230				✓	✓	REC829207	909971	
260				✓	✓	REC3858462	311046	
			1975	Salada Sea Salata Salée		REC3852464	3852464	
235			1971	✓	✓	REC3858462	311046	
			1975-77	✓	✓	REC3852106	311606	
240			1975-84	✓	✓	REC3852106	311606	
250			1979	✓	✓	REC3852106	311606	
245 Jet Drive			1973-75	✓	✓	REC3852106	311606	

			BOMBA AGUA WATER PUMP POMPA ACQUA POMPA D'EAU	DIRECCIÓN HIDRÁULICA POWER STEERING IDROGUIDA DIRECTION HYDRAULIQUE	ALTERNADOR ALTERNATOR ALTERNATORE ALTERNATEUR	REF	OEM
			✓		✓	REC57-48122Q	3852504
262 King Cobra 4.3L (V-6 262)		1989	✓		✓	REC3852106	311606
			✓	✓		REC3852464	3852464
			Salada Sea Salata Salée			GDY15386	910414
290 Jet Drive		1974-75	✓		✓	REC3858462	311046
			✓		✓	REC3858462	311046
305 V-8 305			46"				
		1977-84	Salada Sea Salata Salée			REC3852464	3852464
			50"				
			Salada Sea Salata Salée			REC57-96834Q	912714
325 390 V-8 427					✓	REC57-48122Q	
			✓		✓	REC3858462	311046
350			46"				
		1977-84	Salada Sea Salata Salée			REC3852464	3852464
V-8 350			50"				
			Salada Sea Salata Salée			REC57-96834Q	912714
350 King Cobra			✓		✓	REC3852464	3852464
5.7L (V-8 350)		1988	✓	✓	✓	REC57-48122Q	3852504
370			✓		✓	REC57-78200Q1	3852504
V-8 454			✓	✓		GDY15386	910414
			Salada Sea Salata Salée			REC57-48122Q	3852504
454			✓		✓	REC3852464	3852464
V-8 454		1977-82	Salada Sea Salata Salée			REC57-96834Q	912714
454 King Cobra			✓	✓		REC57-78200Q1	3852504
				✓		GDY15386	910414
V-8 454			Salada Sea Salata Salée			REC57-48122Q	3852504
460 King Cobra 7.5L (V-8 460)		1988	✓	✓	✓	REC829207	909971
			✓	✓		REC57-34359	912714
888 V-8 427			✓		✓	REC966382	
2.3L "4" 140			✓		✓	REC966382	912509
			✓	✓		REC966382	912509
2.5L, 3.0L 181			✓		✓	REC57-36356	910343
2.5L (1982-87)				✓	✓	REC3852106	311606
3.0L 181 (1982-89)				✓		REC829207	909971
			✓		✓	REC57-48122Q	3852504
3.8L (V-6 229)			✓		✓	REC3852106	311606
4.3L (V-6 262)			✓	✓		REC3852464	3852464
3.8L (V-6 229) (1982-86)			✓	✓		REC3852464	3852464
4.3L (V-6 262) (1982-89)			Salada Sea Salata Salée			GDY15386	910414
			✓		✓	REC3852464	3852464
5.0L (V-8 305)			✓	✓	✓	REC57-48122Q	3852504
5.7L (V-8 350)			✓	✓		REC3852464	3852464
5.0L (V-8 305) (1982-87)			✓	✓		REC3852464	3852464
5.7L (V-8 350) (1982-90)			Salada Sea Salata Salée			GDY15386	910414
5.0L (V-8 302)			✓		✓	REC3852106	311606C
5.7L (V-8 351)			✓		✓	REC3852106	311606C
5.0L (V-8 305) (1988)			✓	✓	✓	REC3858462	3858462
5.8L (V-8 351)			✓	✓	✓	REC3858462	3858462
7.5L (V-8 460)		1987	✓	✓	✓	REC829207	909971
			✓	✓		REC57-34359	912714

COMPONENTES DE COLA

GEARHOUSING COMPONENTS

COMPONENTI PIEDE

COMPONENTS D'EMBASES

ACOPLAMIENTOS

COUPLERS

PARASTRAPPI

ACCOUPEMENTS

REF	OEM	AGUJERO HOLE FUORI TROU	CUBO SALIDA HUB OUTER CUBO CUBE	
REC3853962	3853962	Ø 91 mm	Ø 43 mm	2.5L (1986) 3.0L (1986-90), 4.3L, 5.0L, 5.7L (1986) KX & KWB 7.4L (1990-98), 8.2L (1992-93, 1998)



REF	OEM	AGUJERO HOLE FUORI TROU	CUBO SALIDA HUB OUTER CUBO CUBE	
REC3858437	3853917	Ø 76 mm	Ø 43 mm	4.3L (1986-98), 5.0L (1986-88, 1998), 5.7 (1986-92, 1994, 1996-98)



FUELLES CABLE CAMBIO

SHIFT CABLE BELLOWS

CUFFIE CAMBIO

SOUFFLET CÂBLE CHANGEMENT

REF	OEM	
CEF500506	911826	Cobra 1986-93



FUELLES ESCAPE

EXHAUST BELLOWS

CUFFIE SCARICO

SOUFFLET D'ÉCHAPPEMENT

REF	OEM	
REC914036 CEF500527K	914036	Cobra 1986-93



REF	OEM	
REC3852742	3852742	2.3/4.3/5.0/5.7/5.8L (1989-91) 2.3 1987-88, 4.3 1987-89, 5.0-5.8 Ford 1989-90, 5.7 1986, 5.7 1987-91, 1990-91 (350/454/454HO/460 King, 5.7LE 1990-91.

Manguito inferior
Lower hose
Manicotto inferiore
Soufflet inférieur



REF	OEM	
REC3863450	3852741	2.5 1986 3.0 1986-91 2.3 1989-90 4.3 1990-91 5.0-5.8 Ford 1991 5.7 1986.



REF	OEM	
REC3852696	3852696	4.3 1991, 5.0-5.8 Ford 1991, 7.5 (460) 1988-89, 5.7LE 1990-91



REF	OEM	
REC912374 CEF500521K	912374	7.5 (460) 1987, 5.0-5.8 Ford 1989-90, 5.7 1986, 5.7 1987-1988.

Manguito superior
Upper hose
Manicotto superiore
Soufflet supérieur



FUELLES TRANSON

TRANSON BELLOWS

CUFFIE TRANSON

SOUFFLET TRANSON

REF	OEM	
REC3841481 CEF500514K	3854127	Cobra 1986-98



KIT ENGRANAJES TRANSOM

BALL GEAR KIT TRANSOM

KIT INGRANAGGIO TRANSOM

KIT PIGNONES TRANSOM

KIT	REF	OEM					
REC22050	REC25-35029	308621	ARO	O-RING	ANELLO	BAGUE	1
	REC908062	908062	TAPA	BALL GEAR COVER	COPERCHIO	COUVERCLE	2
	REC908063	908063	ENGRANAJE	BALL GEAR	INGRANAGGIO	PIGNON	1
	REC908064	908064	TUERCA	NUT	DADO	ÉCROU	2
	REC908069	321467	ENGRANAJE	BALL GEAR	INGRANAGGIO	PIGNON	1
	REC908383	908383	ARO	O-RING	ANELLO	BAGUE	1
	REC981195	981195	RETÉN	OIL SEAL	PARAOLIO	JOINT SPI	2
	REC981196	981196	RETÉN	OIL SEAL	PARAOLIO	JOINT SPI	2



EJES TRANSMISIÓN

DRIVES SHAFTS

ASSE TRASMISSIONE

ARBRE TRANSMISSION

REF	OEM
REC909121	909121



REF	OEM	
REC981220	981220	V8 - V6



REF	OEM	
REC382883	382883	4 CIL.



KIT PIÑONES Y DESPLAZABLES 14:26

GEAR SETS & CLUTCH DOGS 14:26

KIT PIGNONI E SELETTORI 14:26

KIT PIGNONES ET SELECTEURS 14:26

REF	OEM
REC5004218	986980



REF	OEM		
REC337774	912607	3.8L / 229CI V6	1981-85
		4.3L / 262CI V6	1985
		5.0L / 305CI V8	1981-85
		5.7L / 350CI V8	1981-85



KIT PIÑONES Y DESPLAZABLES 13:26

GEAR SETS & CLUTCH DOGS 13:26

KIT PIGNONI E SELETTORI 13:26

KIT PIGNONES ET SELECTEURS 13:26

REF	OEM
REC986979	986979



REF	OEM		
REC323664	910578 323664	4 Cyl.	
		3.0L (1986-89)	
		2.3L (1987-90)	



CABLE CAMBIO

SHIFT CABLE

CAVO CAMBIO

CÂBLE CHANGEMENT

REF	OEM
REC987661	987661



REF	OEM	
REC987678	985518	
	986423	
	987604	KING COBRA
	987678	



CABLE CAMBIO ELÉCTRICO



ELECTRIC SHIFT CABLE

CAVO CAMBIO ELETTRICO

CÂBLE CHANGEMENT ÉLECTRIQUE

REF	OEM
REC379628	379628



CRUCETAS CARDAN	U-JOINTS	CROCIERA	CARDAN								
<table border="1"> <thead> <tr> <th>REF</th> <th>OEM</th> </tr> </thead> <tbody> <tr> <td>REC75832T</td> <td>912214</td> </tr> </tbody> </table> 	REF	OEM	REC75832T	912214		<table border="1"> <thead> <tr> <th>REF</th> <th>OEM</th> </tr> </thead> <tbody> <tr> <td>REC915716</td> <td>915716</td> </tr> </tbody> </table> 	REF	OEM	REC915716	915716	
REF	OEM										
REC75832T	912214										
REF	OEM										
REC915716	915716										
<table border="1"> <thead> <tr> <th>REF</th> <th>OEM</th> </tr> </thead> <tbody> <tr> <td>REC3850812</td> <td>3850812</td> </tr> </tbody> </table> 	REF	OEM	REC3850812	3850812							
REF	OEM										
REC3850812	3850812										

EJE HÉLICE CAMBIO MECÁNICO	PROP SHAFT MECHANICAL SHIFT	ASSE ELICA CAMBIO MECCANICO	ARBRE HÉLICE CHANGEMENT MECANIQUE		
4 CYL V6-V8					
✓	REC330137 330137	RETEN ACEITE EJE HELICE	OIL SEAL - PROP SHAFT	PARAOLIO ASSE ELICA	JOINT SPI ARBRE HÉLICE
✓	REC26-76868 320862	RETEN ACEITE EJE HELICE	OIL SEAL - PROP SHAFT	PARAOLIO ASSE ELICA	JOINT SPI ARBRE HÉLICE
✓	REC379504 379504	COJINETE ACEITE EJE HELICE	BEARING - PROP SHAFT	CUSCINETTO ASSE ELICA	ROULEMENT HUILE ARBRE
✓	REC387247 387247	COJINETE ACEITE EJE HELICE	BEARING - PROP SHAFT	CUSCINETTO ASSE ELICA	ROULEMENT HUILE ARBRE
✓	REC382407 382407	COJINETE CONTRARROTACIÓN	REVERSE GEAR BEARING CARRIER	CUSCINETTO CONTROROTANTE	ROULEMENT A AIGUILLE
✓	REC314731 314731	TOPE ARANDELA CONTRARROTACIÓN	THRUST WASHER FOR REVERSE GEAR	FERMO CONTROROTANTE	RONDELLE DE CALAGE
✓	REC382408 382408	TOPE COJINETE CONTRARROTACIÓN	THRUST BEARING FOR REVERSE GEAR	FERMO CUSCINETTO CONTROROTANTE	FREIN DE ROULEMENT
✓	REC967344 313446	ARO TÓRICO	O-RING	ANELLO	JOINT TORIQUE
✓	REC305123 305123	ARO TÓRICO	O-RING	ANELLO	JOINT TORIQUE
✓	REC436888 436888	EJE HÉLICE	PROP SHAFT	ASSE ELICA	ARBRE D'HÉLICE
✓	REC395209 395209	EJE HÉLICE	PROP SHAFT	ASSE ELICA	ARBRE D'HÉLICE



HERRAMIENTAS COLAS	STERNDRIVES TOOLS	ATTREZZATURA PIEDI	OUTIL D'EMBASES				
<table border="1"> <thead> <tr> <th>REF</th> <th>OEM</th> </tr> </thead> <tbody> <tr> <td>REC91-805475A1</td> <td>912273</td> </tr> </tbody> </table> 	REF	OEM	REC91-805475A1	912273	ENGINE ALIGNMENT TOOL	ALLINEAMENTO MOTORE	OUTIL D'ALIGNEMENT
REF	OEM						
REC91-805475A1	912273						

SISTEMA DE PROPULSIÓN PROPULSION SYSTEM

SISTEMA DI PROPULSIONE SYSTEME DE PROPULSION

HÉLICES ALUMINIO E
INOXIDABLE
DE 3 Y 4 PALAS

3 & 4 BLADE
ALUMINIUM & SS
PROPELLERS

ELICHE ALLUMINIO E
INOX DA 3 E 4 PALE

HELICE ALUMINIUM ET
INOX 3 ET 4 PALES

CÓDIGO DE REFERENCIAS

PART NO. CODING SYSTEM

SISTEMA DI CODICE

CODAGE DES REFERENCES

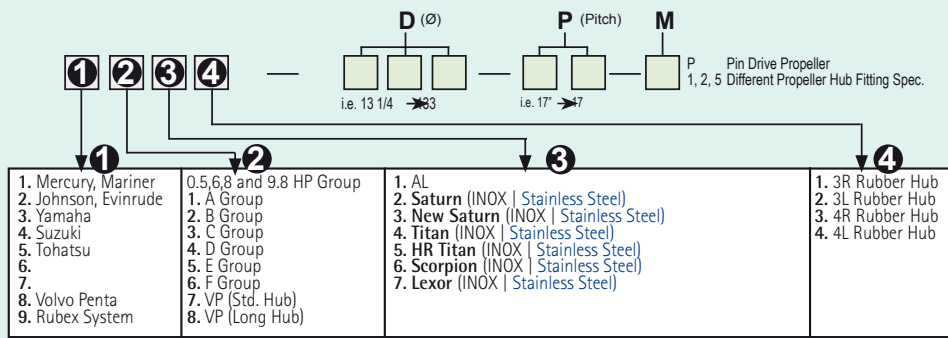

AMITA 3



Hélice de aluminio con núcleo de goma de gran resistencia.

Aluminum propeller with heavy duty rubber hub.

Eliche di alluminio con mozzi in gomma ad alta resistenza.

Hélice en aluminium avec moyeu en caoutchouc



AMITA 3 PLUS



Diseño de pala grande para un área más grande.

High camber blade and large blade area design.

Con un'area più ampia nelle pale.

Conception d'une grande pale pour une plus grande surface de poussée.



HR TITAN 3 PROP



Hélice de acero inoxidable. Alto rendimiento para cascos de alta velocidad. La inclinación de la hoja proporciona un excelente elevación de proa y aceleración. El diseño de copa grande aumenta la mordida y reduce el deslizamiento.

Stainless steel propeller. Performance prop for high speed planning hulls. High rake blade design provides excellent bow lift and acceleration. Heavy cup design increases bite and reduces slip.

Eliche in acciaio inox. Alte prestazioni per scafi ad alta velocità. Il passo della pala fornisce un'eccellente spinta e accelerazione. Il disegno aumenta le prestazioni.

Hélice en acier inoxydable. Hélice de performance pour les coques planantes à grande vitesse. La conception de la pale à haut râteau offre une excellente portance et accélération. La conception des grandes pales augmente l'attaque et réduit le glissement.



NEW SATURN



Hélices de acero inoxidable. Ofrece buena aceleración y rendimiento. Tamaño más pequeño que ofrece un diámetro extragrande.

Stainless steel propeller. Offers good acceleration & all-round performance. Smaller pitch sizes offered in extra large diameter with increased blade area.

Eliche di acciaio inox. Buona accelerazione. Piccole dimensioni che offre un più grande diametro.

Hélice inox, offrant de bonnes accélérations et performances. Taille de pas réduite pour les modèles de grands diamètres avec une surface de pale plus importante.



Palas
Blades
Pale
Pales

Estrias
Tooth Spline
Scalanature
Cannelure

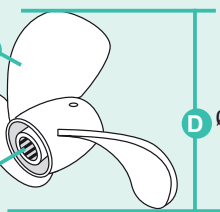

P Paso
Pitch
Passo
Pas

R Rotación L (izquierda) R (derecha)
Rotation L (left) R (Right)
Rotazione L (SX) R (DX)
Rotation L (gauche) R (droit)

GUÍA DE HÉLICES CON NÚCLEO INTEGRADO		PROPELLERS APPLICATION WITH RUBBER HUB					GUIDA ELICHE CON MOZZO		GUIDE DES HELICES AVEC MOYEUR	
OEM	A	B	D	P	R	AL		INOX STAINLESS STEEL		
						AMITA 3	AMITA 4	NEW SATURN	HR TITAN 3	
MOD 400 2,3 L - 3,0 L COBRA 2,3 L - 3,0 L	382761 765181 765182 765183 765184	3	14 13 ^{3/4} 13 ^{1/2} 13 ^{1/4} 13	11 13 15 17 19	R R R R R	AL	SOL2411-140-11 SOL2411-138-13 SOL2411-135-15 SOL2411-133-17 SOL2411-130-19	SOL2413-133-13 SOL2413-130-15 SOL2413-128-17 SOL2413-125-19	SOL2431-135-15 SOL2431-133-17 SOL2431-130-19	
MOD 800 COBRA KING COBRA 3,0 L et 8,2 L	765186 765186 765187 765187 765188 765188 391202 391202 391203 391203	15	15 ^{1/4} 15 ^{1/4} 15 15 14 ^{4/5} 14 ^{4/5} 14 ^{1/2} 14 ^{1/2} 14 ^{1/4} 14 ^{1/4}	15 15 17 17 19 19 21 21 23 23	R L R L R L R L R L	AL	SOL2511-150-15 SOL2512-150-15 SOL2511-148-17 SOL2512-148-17 SOL2511-145-19 SOL2512-145-19 SOL2511-143-21 SOL2512-143-21 SOL2511-142-23 SOL2512-142-23	SOL2513-148-15 SOL2514-148-15 SOL2513-145-17 SOL2514-145-17 SOL2513-143-19 SOL2514-143-19 SOL2513-140-23	SOL2531-145-15 SOL2532-145-15 SOL2531-143-17 SOL2532-143-17 SOL2531-140-19 SOL2532-140-19 SOL2531-140-21 SOL2532-140-21 SOL2531-140-23	
3.0 L 4.3 L 5.0 L 5.7 L 5.8 L 7.4 L	763315 3855479-6 763316 3855480-4 3850301-7 3855481-2 763318		15 15 14.8 14.8 14.5 14.5 14.3	15 15 17 17 19 19 21	R R L R L R L	AL	SOL8611-150-15 SOL8612-150-15 SOL8611-148-17 SOL8612-148-17 SOL8611-145-19 SOL8612-145-19 SOL8611-143-21 SOL8612-143-21 SOL8611-142-23	SOL8613-148-15 SOL8614-148-15 SOL8613-145-17 SOL8614-145-17 SOL8613-143-19 SOL8614-143-19 SOL8613-140-21 SOL8614-140-21		
SX	763319 763304 763305 763306 763307 763308 763309 763310 3850322-3 763312 763313	19	14.2 15 15 15 15 14 ^{1/2} 14 ^{1/2} 14 ^{1/4} 14 ^{1/4} 14 ^{1/4} 14 ^{1/4}	23 15 15 17 17 19 19 21 21 23 23	L R L R L R L R L R L	Inox SS	SOL8611-142-23			SOL8651-148-16 SOL8652-148-16 SOL8651-148-17 SOL8652-148-17 SOL8651-148-19 SOL8652-148-19 SOL8651-145-21 SOL8652-145-21 SOL8651-140-24 SOL8652-140-24

GUÍA DE NÚCLEOS		HUB KIT APPLICATION CHART		GUIDA MOZZI		GUIDE MOYEUR	
REF	A	REF		RUBEX			
400 Cobra, (1978-91)	13	SOLRBX-106	D				
800 Cobra, King Cobra (1978-90)	15	SOLRBX-101	E				
800 Cobra, King Cobra (1991-94),	15	SOLRBX-100	E				
Cobra SX, (1994+),	19	SOLRBX-105	E				

GUÍA DE HÉLICES AL (NÚCLEO NO INCLUIDO)					PROPELLERS AL CHART (HUB NOT INCLUDED)					GUIDA ELICHE AL (MOZZO NON INCLUSO)					GUIDE HÉLICES AL (MOYAU NO INCLUE)				
D (40-140HP)					E (135-300HP)					RUBEX									
B	D	P	R		B	D	P	R											
SOL9411-138-13	14	13	R		SOL9511-150-15	15	15	R											
SOL9411-135-15	3	14	15	R	SOL9511-148-17	3	15	17						R					
SOL9411-133-17	13	17	R		SOL9511-145-19	15	19	R											
SOL9411-132-19	13	19	R		SOL9511-143-21	14	21	R											
SOL9413-133-13	13,3	13	R		SOL9513-148-15	14,8	15	R											
SOL9413-130-15	4	13	15	R	SOL9513-145-17	4	14,5	17						R					
SOL9413-128-17	12,8	17	R		SOL9513-143-19	14,3	19	R											
SOL9413-125-19	13,2	19	R		SOL9513-140-21	14	21	R											

GUÍA DE HÉLICES INOX (NUCLEO NO INCLUIDO)

PROPELLERS SS CHART (HUB NOT INCLUDED)

GUIDA ELICHE INOX (MOZZO NON INCLUSO)

GUIDE HÉLICES INOX (MOYAU NO INCLUDE)

RUBEX

D (40-140HP) NS3	B	D	P	R
SOL9431-138-13	3	13 ^{3/4}	13	R
SOL9432-138-13		13 ^{3/4}	13	L
SOL9431-135-15		13 ^{1/2}	15	R
SOL9432-135-15		13 ^{1/2}	15	L
SOL9431-133-17		13 ^{1/4}	17	R
SOL9432-133-17		13 ^{1/4}	17	L
SOL9431-130-19		13	19	R
SOL9432-130-19		13	19	L
SOL9431-130-21		13	21	R



E (90-140HP) NS3	B	D	P	R
SOL9531-145-15	3	14 ^{1/2}	15	R
SOL9532-145-15		14 ^{1/2}	15	L
SOL9531-143-17		14 ^{1/4}	17	R
SOL9532-143-17		14 ^{1/4}	17	L
SOL9531-140-19		14	19	R
SOL9532-140-19		14	19	L
SOL9531-140-21		14	21	R
SOL9532-140-21		14	21	L
SOL9531-140-23		14	23	R
SOL9532-140-23	14	23	L	

E (135-350HP) L3	B	D	P	R
SOL9571-158-15	3	15 ^{3/4}	15	R
SOL9572-158-15		15 ^{3/4}	15	L
SOL9571-155-17		15 ^{1/2}	17	R
SOL9572-155-17		15 ^{1/2}	17	L
SOL9571-153-19		15 ^{1/4}	19	R
SOL9572-153-19		15 ^{1/4}	19	L
SOL9571-150-21		15	21	R
SOL9572-150-21		15	21	L
SOL9571-148-23		14 ^{3/4}	23	R
SOL9572-148-23	14 ^{3/4}	23	L	

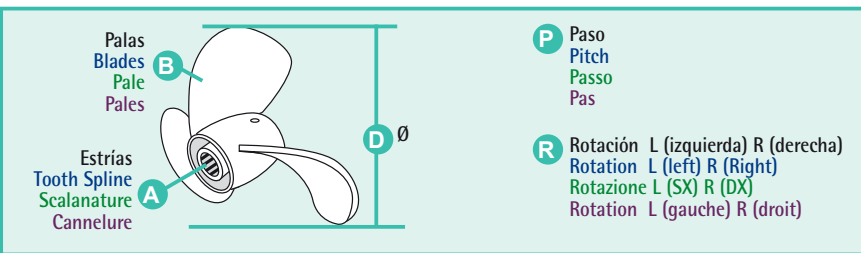

CIERRE DE HÉLICE

PROP HARDWARE

CHIUSURA ELICA

CONE D'HÉLICE

STRINGER 800 COBRA V (1978-87)
 COBRA & KING COBRA (1992-93)
 COBRA, KING & SX (1994+)

TOPE THRUST WASHER FERMO RONDELLE DE FREIN

REF	OEM
REC126870	126870



ESPACIADOR SPACER DISTANZIALE ENTRETOISE

REF	OEM	
REC320570	320570	Stringer 800 Cobra V (1978-87) Cobra & King Cobra (1992-93)
REC3852350	3852350	Cobra, King & SX (1994+)



PASADOR COTTER PIN CHIAVISTELLI GOUPILLE FENDUE

REF	OEM
REC3852056	306394



KITS

REF	OEM	
REC175266	175266	Stringer 800 Cobra V (1978-87) Cobra Et King Cobra (1992-93)

REF	OEM	
REC398042	5008966	

REF	OEM	
REC414153	434153	Stringer 800 Cobra V (1978-87) Cobra Et King Cobra (1992-93)

REF		
REC22188	REC3852350 + REC398042	Cobra, King Et SX (1994+)

STRINGER 400 DRIVES
COBRA 4 CIL (1978-89)
COBRA 2.3L (1990)

TOPE THRUST WASHER FERMO RONDELLE DE FREIN

REF	OEM	
REC127084	127084	

ESPACIADOR SPACER DISTANZIALE ENTRETOISE

REF	OEM	
REC315810	315810	

PASADOR COTTER PIN CHIAVISTELLI GOUPILLE FENDUE

REF	OEM	
REC314502	314502	

TUERCA NUT DADO ÉCROU

REF	OEM	
REC314503	314503	

KITS

REF	OEM	
REC175267	175267	

REF	OEM	
REC5005034	5005034	

REF --> OEM

REF	OEM	
A		
Amita 3		696
Amita 3 PLUS		696
ARC6211	983318	634
ARCVR-404	383440	632

REF	OEM	
B		
BA1-312148	312148	670
BA1-380446	380446	661
BA1-908719	908716	670
BA1-910280	910280	661
BA1-910384	910384	662-663
BAOMC-1-980959	980959	669
BAOMC-1-3852347	3852347	667
BAOMC-1-907885	907885	661-662-663
BAOMC-1-981462	981462	661
BAOMC-1-982657	982657	662
BAOMC-1-984054	984054	663
BAOMC20-908014	908014	662
BAOMC20-910380	3850799	662-663
BAOMC20-980536	980536	661
BAOMC20-980617	980617	669
BAOMC20-981281	981281	669
BAOMC29-314810	314810	637
BAOMC29-314810	982201	637
BAOMC29-908216	908216	637
BAOMC29-910303	3854254	637
BAOMC47-311130	311130	670
BAOMC47-908935	908935	670

REF	OEM	
C		
BRA125-1/2x1/2		622
BRA125-1/2x3/4		622
BRA125-1/2x3/8		622
BRA125-1/4x1/2		622
BRA125-1/4x3/8		622
BRA125-1x3/4		622
BRA125-3/16x1/4		622
BRA125-3/4x3/4		622
BRA125-3/8x1/2		622
BRA125-3/8x3/8		622
BRA125-5/16x3/8		622
BRA125-5/8x3/4		622
BRA125-5/8x3/8		622

REF	OEM	
C		
CEF500317	777128	675
CEF500506	911826	686-693
CEF500514K	3854127	686-693
CEF500521K	912374	693
CEF500527K	914036	686-693
CHARS12YC		639
CHARS9YC		639
CHARV15YC4		639
CM3855411	3855411	681
CM393023	436745	673-677-685
CM393023A	436745	673
CM431708	431708	673-679-685
CM431708A	431708	673
CM983494	983494	685
CM984513	3853818	677
CMC		
CMCC		673

REF	OEM	
F		
FEL17049		656
FEL17060	647-652-658-	659
FEL17068		655-660
FEL17124		651
FEL17145		654-657
FEL17146		652
FEL17160		647-658
FEL17161		647-658
FEL17165		652-659
FEL17166		652-659
FEL17168		655-660
FEL17169		655-660
FEL17205		654
FEL17244		653
FEL17245		653
FEL17260	647-652-658-	659
FEL17261	647-652-658-	659
FEL17268		655-660
FEL17342		657
FEL17360	647-652-658-	659
FEL17368		655-660
FEL17460	913393	669
FEL17460	3852455	667
FEL17468		655-660
FEL17725	649-650-651	649-659
FEL17746		647-659
FEL17936		655
FEL17945	835096	648-652-659-660
FEL17946	3852687	648-652-660
FEL17947		656-660

REF	OEM	
G		
FEL17983		649-651
FEL17985		657
FEL17994		656-660
FEL17995		647-658
FEL17996		652-659
FEL17997		647-658
FEL17998		652-659

REF	OEM	
G		
GDY15386	910414	692-692
GDY17335		691
GS30430		622
GS30431		622
GS30432		622
GS30433		622
GS31055		620-622
GS31056		620-622
GS31065		620
GS31066	22-89771Q2	620-622
GS31067		620
GS31157		620
GS35031		623
GS35032		623
GS35049		622
GS35050		622
GS35051		622
GS35052		622
GS35053		622
GS35054		622
GS35055		622

REF	OEM	
H		
HGE3394	914766	669
HGE5470	985470	637
HGE6041	986041	669
HOT20244-MK		665-666
HOT20903	912442	665
HOT20921	909863	665-669
HR TITAN 3 PROP		

REF	OEM	
H		
LENS3213	35-809097	620
LENS3227	35-886638	620
LENS3240		620

REF	OEM	
M		
MAR061	3857944	664-666-668
MAR499	3847499	664
MAR501	3857723	666
MP0180-001	10-812509184	632
MP426422	772846	625-628
MP426422	3854087	625

REF	OEM	
N		
New Saturn		696
NGKTR5		639
NGKUR4		639

REF	OEM	
P		
PAGB/T848-6	305981	677-684

REF	OEM	
R		
RAC1/2F-1/2M		622
RAC1/2X16		622
RAC1/2X18		622
RAC1/2X20		622
RAC120R-RAC-01		620
RAC3/8F-3/8M		622
RAC3/8X10		622
RAC3/8X12		622
RAC3/8X14		622
RAC320R-INOX-01		620
RAC320R-RAC-01		620
RAC320R-RAC-02	35-802893Q4	619-620
RACRK19492UL		623
RACRK20726		623
RACRK22628		623
RACS3213	35-809097	620
RACS3214	35-809099	620
RACS3220UL	35-809101	619-620
RACS3227	35-886638	620
RACS3228UL	173233	621
RACS3228UL	502901	621
RACS3228UL		620
RACS3240		620
REC0393988	391264	634
REC0393988	393259	634
REC0393988	393988	634
REC0393988	394176	634
REC0393988	983019	634
REC0393988	985237	634
REC0584107	387277	634
REC0584107	582048	634
REC0584107	582155	634

REF	OEM	
REC		
REC0586180	345419	633
REC0586180	383622	633
REC0586180	582708	633
REC0586180	586180	633
REC0979774	979774	633
REC0982706	982058	634
REC0982706	982706	634
REC0984536	984536	631
REC0984536	988013	631
REC0984628	984628	631
REC0985964	985964	633
REC0987883	3854194	631
REC10-20518	912304	686
REC10-37612	3853155	667
REC10-37612	3853326	668
REC10-79953Q04	307551	687
REC10-861788	10-861788	632
REC11-35921	314730	677-685
REC11-8267089	121731	677-685-686
REC11-862903	552938	661-662-663
REC12-191833	311598	688
REC123018	123018	675
REC125017	302540	683-687-688-690
REC12532	382133	640
REC126870	126870	679-681-685-698
REC127084	127084	685-699
REC13-35048	120177	661-662-663-664-666-667-668
REC13-35048	309336	665
REC13-39107	306325	665
REC13-39107	306470	661-662-663
REC13037	1114356	633
REC13430		636
REC1347-816373A4	981359	625-628
REC1347-816373A4	981428	625-628
REC1347-816373A4	981564	625-628
REC1347-816373A4	981705	625-628
REC1347-816373A4	981803	625-628
REC1347-816373A4	982215	625-628
REC1347-816373A4	982223	625-628
REC1347-816373A4	983855	625-628
REC1347-816373A4	985822	625-628
REC1347-818619R02	98053	628
REC1347-818619R02	381494	628
REC1347-818619R02	381498	624
REC1347-818619R02	382733	624-628
REC1347-818619R02	772831	624-628
REC1347-818619R02	979821	628
REC1347-818619R02	980530	624
REC1347-818619R02	982217	624
REC1347-818619R02	984180	624-628
REC1347-9661A3	382821	625-628
REC1347-9661A3	383766	625-628
REC1347-9661A3	384194	625-628
REC1396-4656	982537	626
REC1396-4656	982538	626
REC1396-4656		629
REC1396-5238	982539	626-629
REC1397-2060	381389	628-629
REC1397-2150	983870	621
REC1397-3327	383087	628
REC1397-3327	983871	628-629
REC1397-5831	508452	626
REC1397-6367A1	508459	626
REC1398-3089		629
REC1463-9382	3853548	638
REC15-401		639
REC15-405	503748	639
REC15-601	503750	639
REC15-602	503748	639
REC15-604		639
REC15-801	503752	639
REC15-801	503755	639
REC15-801		639
REC15-805	503753	639
REC15-806	503751	639
REC15-806	503752	639
REC15-806	503754	639
REC15-806	503755	639
REC15-811	503752	639
REC15-811	503755	639
REC16-56826	120177	662
REC16-56826	3852093	661-663
REC16-70236	314616	663
REC160084	160084	679-685
REC17000	908611	644-645
REC17000	3853336	644-645
REC17010	3854299	646
REC17020	3853380	648
REC17030	3853380	649-650
REC17040		653
REC17042		653
REC17048		656
REC17100		644-645

REF	OEM	REF	OEM	REF	OEM
REC17102		REC26901		REC315055	315055 625-661-662-663
REC17110		REC26905		REC315189	315189 683-687-689
REC17115		REC26905		REC315810	315810 685-699
REC17116		REC26904		REC317624	317624 677-684
REC17120		REC27-33395	856034	REC317624	317624 661-662-663
REC17125		REC27-33395	3852468	REC318372	318372 677-690
REC17140		REC27-46820	3852472	REC318717	318717 677-690
REC17146		REC27-52546	311068	REC318972	318972 690
REC17177A1	17177A1	REC27-53354	908079	REC319085	319085 690
REC17200		REC27-8079821	909758	REC32-33189	312781 671
FEL17205		REC27-8146801	311069	REC32-8M0071007	509282 671
REC17207		REC27-8146801	3789161GM	REC320140	320140 690
REC17210		REC27-815528	3853256	REC320570	320570 679-685-698
REC17211		REC27-96429		REC320635	5004941 684
REC17214		REC27-99757	3853412	REC321459	321459 690
REC17220		REC29-47270	318972	REC321466	321466 690
REC17224		REC30-879194A01	3853807	REC321467	321467 684-687-688-690
REC17230		REC300-00879	3852217	REC321480	321480 690
REC17232		REC301877	301877	REC321481	321481 690
REC17240		REC301877	326956	REC321786	321786 690
REC17241		REC301877	326959	REC321787	321787 690
REC17242		REC301967	301967	REC321788	321788 690
REC17243		REC302537	302537	REC321831	321831 690
REC17248		REC302564	302564	REC321895	321895 690
REC17310		REC302588	302588	REC321928	321928 690
REC17320		REC303345	303345	REC322938	322938 679-685
REC17340		REC303347	303347	REC322941	322941 679-685
REC17341		REC304027	304027	REC323338	316499 687
REC17342		REC304174	304174	REC323361	323361 677-684
REC175266	175266	REC305123	305123	REC323362	323362 677-684
REC175267	175267	REC305242	305242	REC323664	323664 685-694
REC17900	3852693	REC305282	305282	REC323664	910578 695
REC17903	3856443	REC306376	306376	REC324369	324369 679-685
REC17920	3854300	REC307450	307450	REC324639	324639 690
REC17921	3854942	REC308590	308590	REC324670	352165 685
REC17930	835096	REC308592	308592	REC324766	324766 679-685
REC17931	3852687	REC308627	308627	REC326649	326649 690
REC17935	856626	REC308768	308768	REC326649	329380 690
REC17937	3853513	REC308799	308799	REC326649	909047 690
REC17950	3853343	REC308825	308825	REC326741	326741 690
REC17970		REC308876	308876	REC326849	326849 690
REC17971	3852655	REC308928	308924	REC327031	327031 690
REC17980	855729	REC309731	309731	REC327656	327656 677-684
REC17981		REC309731	911871	REC327669	327669 679-685
REC17982	3856138	REC309989	309989	REC328096	328096 677-685
REC17986		REC31-35990A1	983891	REC328694	3852473 683
REC18-8553		REC31-66668A1	3854249	REC328702	306358 685
REC183247	3850853	REC31-86748A1	3854250	REC328825	328825 679-685
REC195141		REC310414	310141	REC329922	329922 690
REC21533394	987438	REC310414	310414	REC329923	329923 690
REC21533394	987440	REC310584	310584	REC330137	330137 679-685-690-691-695
REC21533394	987485	REC310599	310599	REC330265	330265 677-685
REC21533394	21533394	REC310649	310649	REC330327	330327 690
REC21533394		REC311121	311121	REC331103	331103 690
REC22-428611	315713	REC313080	313080	REC331188	322501 686-690
REC22-67892A05	318544	REC313080	982946	REC331880	331880 679-685
REC22-67892A05	318544	REC313163	313163	REC331999	331999 677-685
REC22-67892A05	3854539	REC313164	313164	REC332261	332261 690
REC22-67892A05	318544	REC313167	313167	REC332583	305739 690
REC22-73379		REC313175	313175	REC332583	317178 690
REC22050		REC313176	313176	REC332583	332583 690
REC22188		REC313194	313193	REC332583	332583 690
REC24950	35-60494A4	REC313194	313194	REC332583	332584 690
REC25-38933	321117	REC313195	313195	REC332583	911311 686-690
REC25-25439	3852565	REC313196	313196	REC333572	333572 690
REC25-29845	308624	REC313197	313197	REC333957	333957 679-685
REC25-30224	310327	REC313198	313198	REC334163	334163 679
REC25-30224	910582	REC313199	313199	REC334163	982422 685
REC25-30224	310327	REC313200	313200	REC334950	334950 679-690
REC25-30613	310585	REC313202	313202	REC336565	336565 679
REC25-30613	310967	REC313203	313203	REC33662	380537 641
REC25-33145	302337	REC313204	313204	REC33700	380543 642
REC25-35027	303360	REC313205	313205	REC337061	337061 677-685
REC25-35029	308621	REC313206	313206	REC33708	383587 641
REC25-38933	307853	REC313244	313244	REC33765T	980152 640
REC25-38933	322598	REC313282	313282	REC337774	337774 685
REC25-457101	308626	REC313284	313284	REC337774	912607 694
REC25-48171	202893	REC313340	31340	REC337778	337778 677-685
REC25-62702	303191	REC313340	313340	REC338484	324701 689
REC25-62705	311338	REC313353	313353	REC338484	338484 689
REC25-70937	911686	REC313386	313386	REC338484	910338 685-689
REC25-80863	307082	REC313446	313446	REC338518	338518 690
REC25000		REC313448	313448	REC338522	338522 690
REC25010		REC313448	320145	REC339543	339543 690
REC25020		REC313715	313715	REC339620	339620 690
REC25030		REC313754	313754	REC341280	341280 690
REC26-14756		REC314167	314167	REC341281	341281 690
REC26-419533	313392	REC314491	314491	REC341281	341281 690
REC26-419533	764337	REC314502	314502	REC34235T	380538 642
REC26-69188	321453	REC314503	314503	REC3423A1	332205 690
REC26-76868	3286	REC314503	5008966	REC342786	332205 690
REC26-76868	320862	REC314728	314728	REC35-03752	630
REC26-76868		REC314728	314728	REC35-06003	77864 621
REC26900		REC314731	314731	REC35-06004	173834 621
		REC314745	314745		

REF	OEM	REF	OEM	REF	OEM			
REC35-06004	502903	621	REC3854001	986642	640	REC46335	3853404	664-666-667
REC35-06007	502900	621	REC3854001	3854001	640	REC479956		664-666-668
REC35-49088A2	312456	621	REC3854002	3854002	638	REC50-806965A4	988217	632
REC35-49088A2	381690	621	REC3854003	986650	640	REC50-808011A05	981288	631
REC35-53336	908034	621	REC3854003	3854003	640	REC50-808011A05	984982	631
REC35-8M0061975	174144	619	REC3854020	986796	627	REC50-863007A1	3860566	632
REC35-8M0061975	502905	619	REC3854020	3854020	627	REC50-97499A2	981289	631
REC350271	350271	679-685	REC3854020	3854347	627	REC50-97499A2	982202	631
REC3517857	174796	621	REC3854020		629	REC50-99417A2	981078	631
REC3517857	502904	621	REC3854105	987313	627	REC50-99417A2	982121	631
REC353076	353076	690	REC3854105	3854105	627	REC50-99417A2	988217	631
REC3589522	3852561	675-680	REC3854105		629	REC50-99418A2	3860566	632
REC3589524	3852562	675-680	REC3854159	3854159	630	REC5000074	5000074	679-685
REC375761	375761	683	REC3854161	3854161	638	REC5004218	986980	677-679-694
REC379504	379504	679-685-695	REC3854190	987811	632	REC5004257	5004257	679
REC379585	379585	683	REC3854190	3854190	632	REC5004765	5004765	679
REC379628	379628	694	REC3854217	3854217	640	REC5005034	5005034	699
REC3808228	3852544	686	REC3854260	3854260	641	REC502900	502900	621
REC382138	986280	634	REC3854261	3854261	642	REC53773		664
REC382138	3853945	634	REC3854311		642	REC54-815504320	3853786	665
REC382165	382165	683	REC3854331	3854331	641	REC553126	553126	683-690
REC382212	382212	683	REC3854548	3854548	641	REC57-34359	912714	692
REC382407	382407	679-685-695	REC3854549		642	REC57-36356	910343	692
REC382408	382408	679-685-695	REC3854595	3854595	681	REC57-48122Q	3852504	692
REC382883	382883	683-694	REC3855081	311598	677	REC57-78200Q1	3852504	693
REC3841481	3854127	686-693	REC3855081	311598	683	REC57-96834Q	912714	692
REC384195	384195	677-684	REC3855081	311598	685	REC58217	384735	642
REC3850360	986292	637	REC3855081	311598	687	REC59830A7	912212	675-680
REC3850360	987716	637	REC3855081	311598	688	REC62092T	982063	624
REC3850360	3850360	637	REC3855081	333572	680	REC69729	988247	633
REC3850396	3850396	630	REC3855081	333572	681	REC70720		623
REC385043	385043	679-685	REC3855269	3855269	667	REC75832T	912214	675-695
REC3850495	3850495	662-663	REC3855271	3855271	667	REC763891	763891	666
REC3850594		674	REC3855275		681	REC764197	764197	675
REC3850812	3850812	675-680-695	REC3855276	981650	624	REC764799	764799	665-670
REC3850814	3850814	680	REC3857533	3857533	633	REC767970	305987	690
REC3850852	3850852	680	REC3857675	3857675	681	REC777128	777128	675
REC3850942	3850942	681	REC3858261	3854620	624	REC801766		642
REC3851411	3855411	672	REC3858261	3857986	624	REC802385	911702	675
REC3852045	303067	675-680-690	REC3858261	3858261	624	REC806490T	3853787	630
REC3852045	329381	690	REC3858437	3853917	693	REC823426A1	383918	626
REC3852045	909747	690	REC3858462	311046	691	REC823426A1	384743	626
REC3852056	306394	679-681-685-698	REC3858462	3858462	692	REC823426A1	979659	626
REC3852106	311606	691-692	REC3860769	985964	633	REC823426A1	983864	626
REC3852106	311606C	692	REC3860769	986008	633	REC823426A1		629
REC3852142	306422	661-662-663	REC3860842	3860842	680	REC823427A1	982384	626-627-629
REC3852165	910953	680	REC3862228		619	REC829207	310953	691
REC3852272	3852272	680-690	REC3862500	3862500	664-666	REC829207	909971	692-693
REC3852279	3852279	680	REC3863090	3863090	681	REC834975	980892	642
REC3852315	3852315	681	REC3863191	351325	664	REC835702	982336	641
REC3852317	3852317	680	REC3863191	913784	670	REC841243	982342	642
REC3852350	3852350	681-698	REC3863191	3863191	665-666-667-668	REC841994	983073	626
REC3852352	911830	686	REC3863450	3852741	663-664-666-667-668-693	REC841994	984487	626
REC3852454	908668	675-680	REC3863450	3852741	667-668-693	REC841994		629
REC3852455	3852455	647-652-658-659-667-669	REC3863193AL	3855411	672	REC853868	853858	680
REC3852464	3852464	691-692	REC387247	387247	679-685-695	REC853868	3853858	690
REC3852467	3852467	664-665-666	REC387656	387656	677-684	REC854040	3854402	681
REC3852476	909829	670	REC387817	387817	677-684	REC86234A4	982240	624
REC3852476	3852476	667-670	REC3885317		632	REC86234A4	985602	624
REC3852535	911718	686-690	REC389039	389039	679-685	REC86234A4	985603	624
REC3852538	3852538	664-666-668	REC389042	389042	679-685	REC87654		674
REC3852548	3852548	686-691	REC389455	389455	679-685	REC87660		687-688
REC3852550	3852550	686	REC391-5090	382135	642	REC87670		687-688
REC3852560	3852560	680-689	REC391-5090Q1		643	REC878982		670
REC3852568	3852568	675-680	REC392-6316		640	REC879031	983218	689
REC3852602	912627	667	REC392-6324Q1		643	REC89825302	982211	642
REC3852696	3852696	664-666-667-668-693	REC392-6325Q1		643	REC8M0068784	3857532	630
REC3852742	3852742	665-693	REC392-6330	985764	640	REC8M0125617	3855184	630
REC3852830	3852830	664-666-667-668	REC392-9086T	3853814	641	REC8M6001217	382136	641
REC3852865	3852865	681	REC392-9766	3853815	641	REC8M6001219	980893	642
REC3852866	3852866	681	REC393-9459Q1	380541	640	REC8M6001219	987136	642
REC3852928	305270	690	REC393831	912213	675-680	REC8M6001219	987894	642
REC3852959	3852959	681	REC395209	395209	679-685-695	REC8M6001249	987895	641
REC3853283	3853283	625	REC39631		680	REC907761	907761	661-662-663
REC3853341		648-649-650-651	REC397768	397768	672	REC907764	907764	661
REC3853434	3853434	667	REC397768AL	397768	672	REC907774	907774	683-689
REC3853655	3853655	675-690-691	REC398042	398042	685	REC907866	907866	683
REC3853796	982517	671	REC398042	5008966	699	REC908062	908062	683-687-694
REC3853796	3471293	671	REC398042	5008966	679-681	REC908063	908063	687-694
REC3853799	3853799	636	REC41400		630	REC908064	908064	694
REC3853801	3853801	642	REC414153	434153	699	REC908064	908064	683-687
REC3853839	982187	633	REC431708	431708	672	REC908069	321467	694
REC3853839	985063	633	REC431708AL	431708	672	REC908069	908069	683
REC3853854	3853854	635	REC43436	915918	686	REC908087	908087	683-689
REC3853855	3853855	635	REC434467	434467	679	REC908158	908158	679-685-686
REC3853856	3853856	635	REC436745	436745	672	REC908194	908194	690
REC3853857	3853857	635	REC436745AL	436745	672	REC908194	908194	687-688
REC3853934	3853934	681	REC436888	436888	679-685-695	REC908383	908383	687-690-694
REC3853945	986280	634	REC439967	439967	678	REC908765	908765	625
REC3853945	3853945	634	REC439967	984458	678	REC908855	908855	687-690
REC3853983	3853983	636	REC46-8M0113733	3858340	671	REC909048	909048	683-690
			REC46-8M0113734	985429	671	REC909121	909121	683-694
			REC46-8M0113734	3853850	671	REC909123	909123	683
			REC46-8M0113735	3855991	671	REC909139	909139	683-690
			REC46335	908700	665			

REF	OEM	REF	OEM	REF	OEM
REC909140	909140	REC984461	674	SOL8611-145-19	3850301-7 697
REC909232	909232	REC984462	677	SOL8611-148-17	763316 697
REC909316	909316	REC984491	621	SOL8611-150-15	763315 697
REC909368	909368	REC984744	675	SOL8612-143-21	697
REC909371	909371	REC985052	627-629	SOL8612-145-19	3855481-2 697
REC909515	909515	REC985218	641	SOL8612-148-17	3855480-4 697
REC909527	909527	REC985612	678	SOL8612-150-15	3855479-6 697
REC909604	909604	REC986158	672	SOL8613-140-21	763318 697
REC909610	909610	REC986158AL	672	SOL8613-143-19	3850301-7 697
REC909753	909753	REC986782	627-629	SOL8613-145-17	763316 697
REC91-805475A1	912273	REC986799	627	SOL8613-148-15	763315 697
REC910236	910236	REC986799	629	SOL8614-140-21	697
REC910238	910238	REC986838	629	SOL8614-143-19	3855481-2 697
REC910240	910240	REC986979	677-679-694	SOL8614-145-17	3855480-4 697
REC910310	910310	REC987067	672	SOL8614-148-15	3855479-6 697
REC910389	910389	REC987067AL	672	SOL8651-140-24	763312 697
REC911019	911019	REC987315	627-629	SOL8651-145-21	763310 697
REC911668	911668	REC987661	686-694	SOL8651-148-16	763304 697
REC911678	911678	REC987678	694	SOL8651-148-17	763306 697
REC911679	911679	REC987678	694	SOL8651-148-19	763308 697
REC911680	911680	REC987678	694	SOL8652-140-24	763313 697
REC911681	911681	REC987678	686-694	SOL8652-145-21	3850322-3 697
REC911685	911685	REC987739	643	SOL8652-148-16	763305 697
REC911693	911693	REC987739	643	SOL8652-148-17	763307 697
REC911697	911697	REC987739	643	SOL8652-148-19	763309 697
REC911698	911698	REC987739	643	SOL9411-132-19	697
REC911699	911699	REC987739	643	SOL9411-133-17	697
REC911700	911700	REC987739	643	SOL9411-135-15	697
REC911703	911703	REC987739	643	SOL9411-138-13	697
REC911704	911704	REC987739	643	SOL9413-125-19	697
REC911705	911705	REC987739	643	SOL9413-128-17	697
REC911715	911715	REC987739	643	SOL9413-130-15	697
REC911750	911750	REC987739	643	SOL9413-133-13	697
REC911751	911751	REC987739	643	SOL9431-130-19	698
REC911753	911753	REC987739	643	SOL9431-130-21	698
REC911878	911878	REC987800	673	SOL9431-133-17	698
REC911937	911937	REC9D-116	673	SOL9431-135-15	698
REC911962	385367	REC9D-116	673	SOL9431-138-13	698
REC911962	911962	REC9D-116	673	SOL9432-130-19	698
REC912127	912127	REC9D-116	673	SOL9432-133-17	698
REC912157	912157	REC9D-116	673	SOL9432-133-17	698
REC912238	912238	REC9D-116	673	SOL9432-135-15	698
REC912374	912374	REC9D-116	673	SOL9432-138-13	698
REC912614	912614	REC9D-116	673	SOL9511-143-21	697
REC913393	913393	REC9D-116	673	SOL9511-145-19	697
REC914036	914036	REC9D-116	673	SOL9511-148-17	697
REC914488	914488	REC9D-116	673	SOL9511-150-15	697
REC915716	915716	REC9D-116	673	SOL9513-140-21	697
REC915719	915719	REC9D-116	673	SOL9513-143-19	697
REC915720	915720	REC9D-116	673	SOL9513-145-17	697
REC915840	915840	REC9D-116	673	SOL9513-148-15	697
REC915954	915954	REC9D-116	673	SOL9531-140-19	698
REC925093	320303	REC9D-116	673	SOL9531-140-23	698
REC925093	925093	REC9D-116	673	SOL9531-143-17	698
REC966382	912509	REC9D-116	673	SOL9531-145-15	698
REC967344	313446	REC9D-116	673	SOL9532-140-19	698
REC967344	3852308	REC9D-116	673	SOL9532-140-21	698
REC97258A1	171960	REC9D-116	673	SOL9532-140-23	698
REC976669	976669	REC9D-116	673	SOL9532-143-17	698
REC976669AL	976669	REC9D-116	673	SOL9532-145-15	698
REC980183	980183	REC9D-116	673	SOL9571-148-23	698
REC981195	981195	REC9D-116	673	SOL9571-150-21	698
REC981196	981196	REC9D-116	673	SOL9571-153-19	698
REC981220	981220	REC9D-116	673	SOL9571-155-17	698
REC981268	981268	REC9D-116	673	SOL9571-158-15	698
REC981797	981797	REC9D-116	673	SOL9572-148-23	698
REC981799	981799	REC9D-116	673	SOL9572-150-21	698
REC981801	981801	REC9D-116	673	SOL9572-153-19	698
REC981911	981911	REC9D-116	673	SOL9572-155-17	698
REC982209	982209	REC9D-116	673	SOL9572-158-15	698
REC982230	982230	REC9D-116	673	SOLRBX-100	697
REC982386	381400	REC9D-116	673	SOLRBX-101	697
REC982386	982386	REC9D-116	673	SOLRBX-105	697
REC982386	982386	REC9D-116	673	SOLRBX-106	697
REC982422	982422	REC9D-116	673		
REC982438	982438	REC9D-116	673		
REC982438AL	982438	REC9D-116	673	TRI305-0386	623
REC982946	982946	REC9D-116	673	TRI305-0566	623
REC982947	982947	REC9D-116	673		
REC982949	982949	REC9D-116	673		
REC982997	982997	REC9D-116	673		
REC983298	983298	REC9D-116	673		
REC983494	983494	REC9D-116	673		
REC983494AL	983494	REC9D-116	673		
REC983825	983825	REC9D-116	673		
REC983826	983826	REC9D-116	673		
REC983877	983877	REC9D-116	673		
REC983878	983878	REC9D-116	673		
REC983880	983880	REC9D-116	673		
REC983892	983892	REC9D-116	673		
REC983952	984547	REC9D-116	673		
REC983952AL	983952	REC9D-116	673		
REC983967	983967	REC9D-116	673		
REC984012	984012	REC9D-116	673		
REC984264	984264	REC9D-116	673		

OEM --> REF

OEM	REF	OEM	REF	OEM	REF
3286	REC26-76868	690	311598	REC3855081	687
31340	REC313340	690	311598	REC3855081	688
98053	REC1347-818619R02	628	311606	REC3852106	691-692
120177	REC13-35048	661-662-663-664-666-667-668	312148	BA1-312148	670
120177	REC16-56826	662	312456	REC35-49088A2	621
121731	REC11-8267089	677-685-686	312781	REC32-33189	671
123018	REC123018	675	313080	REC313080	687
126870	REC126870	679-681-685-698	313163	REC313163	683
127084	REC127084	685-699	313164	REC313164	683
160084	REC160084	679-685	313167	REC313167	683
171960	REC97258A1	630	313175	REC313175	675-683-690
173233	RACS3228UL	621	313176	REC313176	683-689
173834	REC35-06004	621	313193	REC313194	683
174144	REC35-8M0061975	619	313194	REC313194	683
174796	REC3517857	621	313195	REC313195	683
175266	REC175266	699	313196	REC313196	683
175267	REC175267	699	313197	REC313197	683
202893	REC25-48171	686-690	313198	REC313198	683
301877	REC301877	690	313199	REC313199	683
301967	REC301967	690	313200	REC313200	683
302337	REC25-33145	686-687-690	313202	REC313202	683
302537	REC302537	690	313203	REC313203	683
302540	REC125017	683-687-688-690	313204	REC313204	683
302564	REC302564	690	313205	REC313205	683
302588	REC302588	690	313206	REC313206	683
303067	REC3852045	675-680-690	313244	REC313244	687
303191	REC25-62702	690	313282	REC313282	690
303345	REC303345	690	313284	REC313284	690
303347	REC303347	690	313340	REC313340	690
303360	REC25-35027	690	313353	REC313353	685-690
304027	REC304027	677	313368	REC313368	689
304174	REC304174	686-690	313392	REC26-419533	690
305123	REC305123	685-690-695	313446	REC313446	685
305242	REC305242	690	313446	REC967344	679-690-695
305270	REC3852928	690	313448	REC313448	679-685
305282	REC305282	683	313715	REC313715	679-685
305739	REC332583	690	313754	REC313754	690
305981	PAGB/T848-6	677-684	314167	REC314167	690
305987	REC767970	690	314218	REC341281	690
306325	REC13-39107	665	314281	REC341281	690
306358	REC328702	685	314491	REC314491	683-689-690
306376	REC306376	685	314502	REC314502	685-699
306394	REC3852056	679-681-685-698	314503	REC314503	699
306422	REC3852142	661-662-663	314616	REC16-70236	663
306470	REC13-39107	661-662-663	314728	REC314728	677-690
307082	REC25-80863	690	314728	REC314728	684
307450	REC307450	690	314730	REC11-35921	677-685
307551	REC10-79953Q04	687	314731	REC314731	679-685-695
307853	REC25-38933	690	314745	REC314745	677-684
308590	REC308590	683	314810	BAOMC29-314810	637
308592	REC308592	683	315055	REC315055	625-661-662-663
308621	REC25-35029	683-690-694	315189	REC315189	683-687-689
308624	REC25-29845	690	315713	REC22-428611	664-665-666-667-668
308626	REC25-457101	687-690	315810	REC315810	685-699
308627	REC308627	690	316499	REC323338	687
308768	REC308768	683	317178	REC332583	690
308799	REC308799	687-688	317624	REC317624	677-684
308825	REC308825	677-686	318372	REC318372	677-690
308876	REC308876	690	318544	REC22-67892A05	677
308924	REC308928	683	318544	REC22-67892A05	685
309336	REC13-35048	665	318544	REC22-67892A05	683
309731	REC309731	690	318717	REC318717	677-690
309989	REC309989	690	318972	REC29-47270	690
310141	REC310141	690	318972	REC318972	690
310327	REC25-30224	690	319085	REC319085	690
310327	REC25-30224	683	320140	REC320140	690
310414	REC310414	690	320145	REC313448	685
310584	REC310584	689-690	320303	REC925093	690
310585	REC25-30613	689-690	320570	REC320570	679-685-698
310599	REC310599	690	320862	REC26-76868	685-690-695
310649	REC310649	684-690	321117	REC25-38933	690
310953	REC829207	691	321453	REC26-69188	690
310967	REC25-30613	690	321459	REC321459	690
311046	REC3858462	692	321466	REC321466	690
311068	REC27-52546	661-662	321467	REC321467	684-687-688-690
311069	REC27-8146801	689	321467	REC908069	694
311121	REC311121	661-662-663	321480	REC321480	690
311130	BAOMC47-311130	670	321481	REC321481	690
311338	REC25-62705	690	321786	REC321786	690
311598	REC12-191833	688	321787	REC321787	690
311598	REC3855081	677	321788	REC321788	690
311598	REC3855081	683	321831	REC321831	690
311598	REC3855081	685	321895	REC321895	690
311598	REC3855081	685	321928	REC321928	690
322501	REC331188	686-690			
322598	REC25-38933	690			
322938	REC322938	679-685			
322941	REC322941	679-685			
323361	REC323361	677-684			
323362	REC323362	677-684			
323664	REC323664	685-694			
324369	REC324369	679-685			
324639	REC324639	690			
324701	REC338484	689			
324766	REC324766	679-685			
326649	REC326649	690			
326741	REC326741	690			
326849	REC326849	690			
326956	REC301877	690			
326959	REC301877	690			
327031	REC327031	690			
327656	REC327656	677-684			
327669	REC327669	679-685			
328096	REC328096	677-685			
328825	REC328825	679-685			
329380	REC326649	690			
329381	REC3852045	690			
329922	REC329922	690			
329923	REC329923	690			
330137	REC330137	679-685-690-691-695			
330265	REC330265	677-685			
330327	REC330327	690			
331103	REC331103	690			
331880	REC331880	679-685			
331999	REC331999	677-685			
332205	REC342786	690			
332261	REC332261	690			
332583	REC332583	690			
332584	REC332583	690			
333572	REC333572	690			
333572	REC3855081	680			
333572	REC3855081	681			
333957	REC333957	679-685			
334163	REC334163	679			
334950	REC334950	679-690			
336565	REC336565	679			
337061	REC337061	677-685			
337774	REC337774	685			
337778	REC337778	677-685			
338484	REC338484	689			
338518	REC338518	690			
338522	REC338522	690			
339543	REC339543	690			
339620	REC339620	690			
341280	REC341280	690			
345419	REC0586180	633			
350271	REC350271	679-685			
351325	REC3863191	664			
352165	REC324670	685			
353076	REC353076	690			
375761	REC375761	683			
379504	REC379504	679-685-695			
379585	REC379585	683			
379628	REC379628	694			
380446	BA1-380446	661			
380537	REC33662	641			
380538	REC34235T	642			
380541	REC393-9459Q1	640			
380543	REC33700	642			
381389	REC1397-2060	628-629			
381400	REC982386	626			
381494	REC1347-818619R02	628			
381498	REC1347-818619R02	624			
381690	REC35-49088A2	621			
382125	REC8M6001217	641			
382133	REC12532	640			
382135	REC391-5090	642			
382136	REC8M6001217	641			
382165	REC382165	683			
382212	REC382212	683			
382407	REC382407	679-685-695			
382408	REC382408	679-685-695			
382733	REC1347-818619R02	624-628			
382761	SOL2411-140-11	697			
382821	REC1347-9661A3	625-628			
382883	REC382883	683-694			
383087	REC1397-3327	628			
383440	ARCVR-404	632			
383587	REC33708	641			

OEM	REF		OEM	REF		OEM	REF	
383622	REC0586180	633	763319	SOL8611-142-23	697	909604	REC909604	685
383766	REC1347-9661A3	625-628	763891	REC763891	666	909610	REC909610	665
383918	REC823426A1	626	764197	REC764197	675	909747	REC3852045	690
384194	REC1347-9661A3	625-628	764337	REC26-419533	687	909753	REC909753	683-689
384195	REC384195	677-684	764799	REC764799	665-670	909758	REC27-8079821	625
384735	REC58217	642	765181	SOL2411-138-13	697	909829	REC3852476	670
384743	REC823426A1	626	765181	SOL2413-133-13	697	909863	HOT20921	665-669
385043	REC385043	679-685	765182	SOL2411-135-15	697	909971	REC829207	692
385367	REC911962	679	765182	SOL2413-130-15	697	910236	REC910236	685
387247	REC387247	679-685-695	765182	SOL2431-135-15	697	910238	REC910238	683-689-690
387277	REC0584107	634	765183	SOL2411-133-17	697	910240	REC910240	683
387656	REC387656	677-684	765183	SOL2413-128-17	697	910280	BA1-910280	661
387817	REC387817	677-684	765183	SOL2431-133-17	697	910310	REC910310	685
389039	REC389039	679-685	765184	SOL2411-130-19	697	910338	REC338484	685-689
389042	REC389042	679-685	765184	SOL2413-125-19	697	910343	REC57-36356	692
389455	REC389455	679-685	765184	SOL2431-130-19	697	910384	BA1-910384	662-663
391202	SOL2511-143-21	697	765186	SOL2511-150-15	697	910389	REC910389	662
391202	SOL2512-143-21	697	765186	SOL2512-150-15	697	910414	GDY15386	692
391202	SOL2531-140-21	697	765186	SOL2513-148-15	697	910578	REC323664	694
391202	SOL2532-140-21	697	765186	SOL2514-148-15	697	910582	REC25-30224	683-690
391203	SOL2511-142-23	697	765186	SOL2531-145-15	697	910953	REC3852165	680
391203	SOL2512-142-23	697	765186	SOL2532-145-15	697	910953	RM3852516	675
391203	SOL2513-140-23	697	765187	SOL2511-148-17	697	911019	REC911019	688-690
391203	SOL2531-140-23	697	765187	SOL2512-148-17	697	911311	REC332583	686-690
391264	REC0393988	634	765187	SOL2513-145-17	697	911668	REC911668	675
393259	REC0393988	634	765187	SOL2514-145-17	697	911678	REC911678	675
393988	REC0393988	634	765187	SOL2531-143-17	697	911679	REC911679	675
394176	REC0393988	634	765187	SOL2532-143-17	697	911680	REC911680	675
395209	REC395209	679-685-695	765188	SOL2511-145-19	697	911681	REC911681	675
397768	REC397768	672	765188	SOL2512-145-19	697	911685	REC911685	675-690
397768	REC397768AL	672	765188	SOL2513-143-19	697	911686	REC25-70937	675-690
398042	REC398042	685	765188	SOL2514-143-19	697	911693	REC911693	677
431708	CM431708	679-685	765188	SOL2531-140-19	697	911697	REC911697	675
431708	REC431708	672	765188	SOL2532-140-19	697	911698	REC911698	675
431708	REC431708AL	672	772831	REC1347-818619R02	624-628	911699	REC911699	675
434153	REC414153	699	772846	MP426422	625-628	911700	REC911700	675-690
434467	REC434467	679	777128	CEF500317	675	911702	REC802385	675
436745	CM393023	677-685	777128	REC777128	675	911703	REC911703	675
436745	REC436745	672	778864	REC35-06003	621	911704	REC911704	675
436745	REC436745AL	672	835096	FEL17945	648-652-659-660	911705	REC911705	677
436888	REC436888	679-685-695	835096	REC17930	649-650-651	911715	REC911715	677
439967	REC439967	678	853858	REC853858	680	911718	REC3852535	686-690
502900	REC35-06007	621	855729	REC17980	649-650-651	911750	REC911750	675
502900	REC502900	621	856034	REC27-33395	648	911751	REC911751	675
502901	RACS3228UL	621	856365	REC17320	648-650-651	911753	REC911753	675
502903	REC35-06004	621	856626	REC17935	655-657	911826	CEF500506	686-693
502904	REC3517857	621	857177	REC17310	646	911830	REC3852352	686
502905	REC35-8M0061975	619	907761	REC907761	661-662-663	911871	REC309731	686-690
502906	RM3862228	619	907764	REC907764	661	911878	REC911878	677
503748	REC15-405	639	907774	REC907774	683-689	911937	REC911937	675
503748	REC15-602	639	907866	REC907866	683	911962	REC911962	685
503750	REC15-601	639	907885	BAOMC1-907885	661-662-663	912127	REC912127	677-685
503751	REC15-806	639	908014	BAOMC20-908014	662	912157	REC912157	677
503752	REC15-801	639	908034	REC35-53336	621	912212	REC59830A7	675-680
503752	REC15-806	639	908062	REC908062	683-687-694	912213	REC393831	675-680
503752	REC15-811	639	908063	REC908063	687-694	912214	REC75832T	675-695
503753	REC15-805	639	908064	REC908064	694	912238	REC912238	675
503754	REC15-806	639	908064	REC908064	683-687	912273	REC91-805475A1	695
503755	REC15-801	639	908069	REC908069	683	912304	REC10-20518	686
503755	REC15-806	639	908079	REC27-53354	663-645	912374	CEF500521K	693
503755	REC15-811	639	908087	REC908087	683-689	912374	REC912374	665-693
508452	REC1397-5831	626	908158	REC908158	679-685-686	912392	TEN00712	679
508459	REC1397-6367A1	626	908194	REC908194	690	912442	HOT20903	665
509282	REC32-8M0071007	671	908194	REC908194	687-688	912509	REC966382	691-692
552938	REC11-862903	661-662-663	908216	BAOMC29-908216	637	912607	REC337774	694
552940	REC317624	661-662-663	908383	REC908383	687-690-694	912614	REC912614	675
553126	REC553126	683-690	908611	REC17000	644-645	912627	REC3852602	667
582048	REC0584107	634	908668	REC3852454	675-680	912714	REC57-34359	692
582155	REC0584107	634	908700	REC46335	665	912714	REC57-96834Q	692
582708	REC0586180	633	908716	BA1-908719	670	913393	FEL17460	669
586180	REC0586180	633	908765	REC908765	625	913393	REC913393	658-669
763304	SOL8651-148-16	697	908855	REC908855	687-690	913784	REC3863191	670
763305	SOL8652-148-16	697	908935	BAOMC47-908935	670	914036	CEF500527K	686-693
763306	SOL8651-148-17	697	909047	REC326649	690	914036	REC914036	686-693
763307	SOL8652-148-17	697	909048	REC909048	683-690	914488	REC914488	675
763308	SOL8651-148-19	697	909121	REC909121	683-694	914766	HGE3394	669
763309	SOL8652-148-19	697	909123	REC909123	683	915716	REC915716	695
763310	SOL8651-145-21	697	909139	REC909139	683-690	915719	REC915719	677
763312	SOL8651-140-24	697	909140	REC909140	683-690	915720	REC915720	677
763313	SOL8652-140-24	697	909232	REC909232	662-663-665	915840	REC915840	675-686-688
763315	SOL8611-150-15	697	909316	REC909316	675-690	915918	REC43436	686
763315	SOL8613-148-15	697	909368	REC909368	661	915954	REC915954	679
763316	SOL8611-148-17	697	909371	REC909371	661-662-663-665	925093	REC925093	680
763316	SOL8613-145-17	697	909515	REC909515	687	976669	REC976669	672
763318	SOL8611-143-21	697	909527	REC909527	687-688	976669	REC976669AL	672
763318	SOL8613-140-21	697				979659	REC823426A1	626

OEM	REF		OEM	REF		OEM	REF	
979774	REC0979774	633	984276	REC987739	643	3852308	REC967344	680
979821	REC1347-818619R02	628	984281	REC987739	643	3852315	REC3852315	681
980152	REC33765T	640	984387	GS38322	665	3852317	REC3852317	680
980183	REC980183	687	984458	REC439967	678	3852347	BAOMC1-3852347	667
980530	REC1347-818619R02	624	984462	REC984462	677	3852350	REC3852350	681-698
980536	BAOMC20-980536	661	984487	REC841994	626	3852455	FEL17460	667
980617	BAOMC20-980617	669	984491	REC984491	621	3852455	REC3852455	647-652-658-659-667-669
980892	REC834975	642	984536	REC0984536	631	3852464	REC3852464	691-692
980893	REC8M6001219	642	984547	REC983952	672	3852467	REC3852467	664-665-666
980959	BAOMC-1-980959	669	984547	REC983952AL	672	3852468	REC27-33395	665-666
981195	REC981195	687-690-694	984628	REC0984628	631	3852472	REC27-46820	654-657-668
981196	REC981196	683-690-694	984730	REC987739	643	3852473	REC328694	683
981220	REC981220	683-694	984731	RM3850470	635	3852476	REC3852476	667-670
981268	REC981268	683-690	984744	REC984744	675	3852504	REC57-48122Q	692
981281	BAOMC20-981281	669	984982	REC50-808011A05	631	3852504	REC57-78200Q1	693
981288	REC50-808011A05	631	985052	REC985052	627-629	3852538	REC3852538	664-666-668
981289	REC50-97499A2	631	985063	REC3853839	633	3852544	REC3808228	686
981359	REC1347-816373A4	625-628	985218	REC985218	641	3852548	REC3852548	686-691
981428	REC1347-816373A4	625-628	985237	REC0393988	634	3852550	REC3852550	686
981462	BAOMC1-981462	661	985429	REC46-8M0113734	671	3852560	REC3852560	680-689
981564	REC1347-816373A4	625-628	985470	HGE5470	637	3852561	REC3589522	675-680
981650	REC3855276	624	985518	REC987678	694	3852562	REC3589524	675-680
981705	REC1347-816373A4	625-628	985602	REC86234A4	624	3852565	REC25-25439	675-680-690
981797	REC981797	688	985603	REC86234A4	624	3852568	REC3852568	675-680
981801	REC981801	688	985612	REC985612	678	3852604	GS38320	661-662-663-664-665-666-667-668
981803	REC1347-816373A4	625-628	985764	REC392-6330	640	3852655	REC17971	646
981911	REC981911	621	985822	REC1347-816373A4	625-628	3852687	FEL17946	648-652-660
982058	REC0982706	634	985902	REC987739	643	3852687	REC17931	649-651
982063	REC62092T	624	985964	REC0985964	633	3852693	REC17900	645
982187	REC3853839	633	985964	REC3860769	633	3852696	REC3852696	664-666-667-668-693
982201	BAOMC29-314810	637	986008	REC3860769	633	3852741	REC3863450	663-664-666-667-668-693
982202	REC50-97499A2	631	986041	HGE6041	669	3852742	REC3852742	667-668-693
982209	REC982209	641	986280	REC382138	634	3852830	REC3852830	664-666-667-668
982211	REC89825302	642	986280	REC3853945	634	3852865	REC3852865	681
982215	REC1347-816373A4	625-628	986292	REC3850360	637	3852866	REC3852866	681
982217	REC1347-818619R02	624	986342	REC987739	643	3852959	REC3852959	681
982223	REC1347-816373A4	625-628	986423	REC987678	694	3853155	REC10-37612	667
982230	REC982230	621	986642	REC3854001	640	3853256	REC27-815528	645
982240	REC86234A4	624	986650	REC3854003	640	3853283	REC3853283	625
982336	REC835702	641	986782	REC986782	627-629	3853326	REC10-37612	668
982342	REC841243	642	986784	REC986799	627	3853326	REC27-815528	645
982384	REC823427A1	626-627-629	986796	REC3854020	627	3853326	REC3853283	625
982386	REC982386	626	986799	REC986799	627	3853326	REC10-37612	668
982422	REC334163	685	986837	REC987739	643	3853336	REC17000	644-645
982422	REC982422	684	986838	REC986838	677	3853343	REC17950	645
982438	REC982438	672	986979	REC986979	677-679-694	3853380	REC17020	648
982438	REC982438AL	672	986980	REC5004218	677-679-694	3853380	REC17030	649-650
982517	REC3853796	671	987136	REC8M6001219	642	3853404	REC46335	664-666-667
982537	REC1396-4656	626	987313	REC3854105	627	3853412	REC27-99757	646-664
982538	REC1396-4656	626	987315	REC987315	627-629	3853434	REC3853434	667
982539	REC1396-5238	626-629	987438	REC21533394	627	3853513	REC17937	655-657
982657	BAOMC1-982657	662	987440	REC21533394	627	3853548	REC1463-9382	638
982706	REC0982706	634	987485	REC21533394	627	3853655	REC3853655	675-690
982749	REC987739	643	987604	REC987678	694	3853786	REC54-815504320	665
982755	REC987739	643	987661	REC987661	686-694	3853787	REC806490T	630
982774	REC987739	643	987678	REC987678	686-694	3853799	REC3853799	636
982946	REC313080	688	987716	REC3850360	637	3853801	REC3853801	642
982946	REC982946	688	987738	REC987739	643	3853807	REC30-879194A01	686
982947	REC982947	688	987739	REC987739	643	3853814	REC392-9086T	641
982997	REC982997	624	987740	REC987739	643	3853815	REC392-9766	641
983019	REC0393988	634	987754	RM3862228	619	3853818	CM984513	672-677
983073	REC841994	626	987800	REC987800	673	3853850	REC46-8M0113734	671
983218	REC879031	689	987811	REC3854190	632	3853854	REC3853854	635
983298	REC983298	683-689	987894	REC8M6001219	642	3853855	REC3853855	635
983318	ARC6211	634	987895	REC8M6001249	641	3853856	REC3853856	635
983494	CM983494	685	988013	REC0984536	631	3853857	REC3853857	635
983494	REC983494	672	988217	REC50-806965A4	632	3853858	REC853868	690
983494	REC983494AL	672	988247	REC69729	633	3853860	GS38322	664-666-667-668
983825	REC983825	675	1114356	REC13037	633	3853917	REC3858437	693
983826	REC983826	675	3471293	REC3853796	671	3853930	REC986158	672
983855	REC1347-816373A4	625-628	3847499	MAR499	664	3853930	REC986158AL	672
983864	REC823426A1	626	3850360	REC3850360	637	3853930	TEN00919	686
983870	REC1397-2150	621	3850396	REC3850396	630	3853934	REC3853934	681
983871	REC1397-3327	628-629	3850470	RM3850470	635-686	3853945	REC382138	634
983877	REC983877	675	3850495	REC3850495	662-663	3853945	REC3853945	634
983878	REC983878	675	3850799	BAOMC20-910380	662-663	3854001	REC3854001	640
983880	REC983880	675	3850812	REC3850812	675-680-695	3854002	REC3854002	638
983891	REC31-35990A1	675	3850814	REC3850814	680	3854003	REC3854003	640
983892	REC983892	675	3850852	REC3850852	680	3854020	REC3854020	627
983939	RM3850470	635	3850853	REC183247	680	3854061	REC987067	672
983967	REC983967	675	3850942	REC3850942	681	3854061	REC987067AL	672
984012	REC984012	675	3851982	SHEG9903	637	3854086	RM21610333	625-628
984036	REC987739	643	3852093	REC16-56826	661-663	3854087	MP426422	625
984054	BAOMC1-984054	663	3852217	REC300-00879	638	3854105	REC3854105	627
984180	REC1347-818619R02	624-628	3852272	REC3852272	680-690			
984264	REC984264	675	3852279	REC3852279	680			

OEM	REF	
3854127	CEF500514K	686-693
3854127	REC3841481	686-693
3854159	REC3854159	630
3854161	REC3854161	638
3854190	REC3854190	632
3854194	REC0987883	631
3854217	REC3854217	640
3854249	REC31-66668A1	681
3854250	REC31-86748A1	681-687
3854254	BAOMC29-910303	637
3854260	REC3854260	641
3854261	REC3854261	642
3854299	REC17010	646
3854300	REC17920	647
3854331	REC3854331	641
3854347	REC3854020	627
3854402	REC854040	681
3854539	REC22-67892A05	681
3854548	REC3854548	641
3854595	REC3854595	681
3854620	REC3858261	624
3854874	RM3854874	664
3854942	REC17921	647
3855079	SHEG9903	637
3855184	REC8M0125617	630
3855269	REC3855269	667
3855271	REC3855271	667
3855411	CM3855411	681
3855411	REC3851411	672
3855411	REC3863193AL	672
3855991	REC46-8M0113735	671
3856138	REC17982	649-651
3856443	REC17903	645
3857532	REC8M0068784	630
3857533	REC3857533	633
3857675	REC3857675	681
3857723	MAR501	666
3857794	SHEG9903	637
3857944	MAR061	664-666-668
3857986	REC3858261	624
3858261	REC3858261	624
3858340	REC46-8M0113733	671
3858462	REC3858462	691
3858847	SHEG9901	637
3860566	REC50-863007A1	632
3860566	REC50-99418A2	632
3860842	REC3860842	680
3861459	RM3861459	668
3862500	REC3862500	664-666
3863090	REC3863090	681
3863191	REC3863191	665-666-667-668
5000074	REC5000074	679-685
5004257	REC5004257	679
5004765	REC5004765	679
5004941	REC320635	684
5005034	REC5005034	699
5008966	REC314503	685
5008966	REC398042	699
5008966	REC398042	679-681
21533394	REC21533394	627
10-812509184	MP0180-001	632
10-861788	REC10-861788	632
17177A1	REC17177A1	640
22-89771Q2	GS31066	620-622
311606C	REC3852106	692
35-60494A4	REC24950	619
35-802893Q4	RAC320R-RAC-02	619-620
35-809097	LENS3213	620
35-809097	RACS3213	620
35-809099	RACS3214	620
35-809101	RACS3220UL	619-620
35-886638	LENS3227	620
35-886638	RACS3227	620
3789161GM	REC27-8146801	689
3850301-7	SOL8611-145-19	697
3850301-7	SOL8613-143-19	697
3850322-3	SOL8652-145-21	697
3855479-6	SOL8612-150-15	697
3855479-6	SOL8614-148-15	697
3855480-4	SOL8612-148-17	697
3855480-4	SOL8614-145-17	697
3855481-2	SOL8612-145-19	697
3855481-2	SOL8614-143-19	697

BARCELONA

Jocelyn Bell, 26
Pol. Ca n'Alemany
08840 Viladecans (Barcelona)
Tel. 900 841 013 - 93 633 34 80
Fax 93 662 66 59

International
phone: (+34) 93 662 66 55
Fax (+34) 93 662 66 59

info@recambiosmarinos.es
www.recambiosmarinos.es

GIRONA

C/ Gironés, 5
Pol. Ind. El Plà
17486 Castelló d'Empúries (Girona)
Tel. (+34) 972 158 809

girona@recmar.es

CANARIAS

Laura Grote de la Puerta, 3, Nave 5
Pol. Industrial El Mayorazgo
38110 Santa Cruz de Tenerife
Tel. (+34) 922 621 499

canarias@recmar.es

ITALIA

RECMAR SRL
Via Israele 10 H
Zona Industriale Settore 7
07026 Olbia (OT)

Tel. (+39) 0789 51962
Fax (+39) 0789 600177
sales@recmar.it